

Inverter

Inverter i550 Cabinet 0.25 ... 75 kW

Contents

1	General information	15
1.1	Read first, then start	15
2	Safety instructions	16
2.1	Basic safety measures	16
2.2	Residual hazards	17
2.3	Application as directed	17
3	Mounting	18
3.1	Important notes	18
3.2	Electrical installation	19
3.2.1	1-phase mains connection 230/240 V	19
3.2.1.1	Connection plan	19
3.2.1.2	Fusing and terminal data	20
3.2.2	1/3-phase mains connection 230/240 V	21
3.2.2.1	Connection plan	21
3.2.2.2	Fusing and terminal data	22
3.2.3	3-phase mains connection 230/240 V	23
3.2.3.1	Connection plan	23
3.2.3.2	Fusing and terminal data	24
3.2.4	3-phase mains connection 400 V	25
3.2.4.1	Connection plan	25
3.2.4.2	Fusing and terminal data	26
3.2.5	3-phase mains connection 480 V	30
3.2.5.1	Connection plan	30
3.2.5.2	Fusing and terminal data	31
3.2.6	CANopen	35
3.2.7	Modbus RTU	36
3.2.8	Modbus TCP	37
3.2.9	PROFIBUS	38
3.2.10	EtherCAT	39
3.2.11	EtherNet/IP	39
3.2.12	PROFINET	40
3.2.13	Connection of the safety module	40
3.2.13.1	Terminal data	40

Contents

4	Commissioning	41
4.1	Important notes	41
4.2	Operating interfaces	42
4.2.1	Keypad	42
4.2.2	Engineering tool »EASY Starter«	43
4.2.2.1	Generate a connection between inverter and »EASY Starter«	44
4.3	Parameter setting	46
4.3.1	General notes on parameters	47
4.3.2	Basic inverter settings	48
4.3.3	Basic motor settings	50
4.3.4	Function assignment of the inputs and outputs	52
4.4	Keypad parameter list	55
4.5	Save parameter settings in the memory module	83
4.5.1	Save parameter settings with keypad	83
4.5.2	Save parameter settings with »EASY Starter«	83
5	Diagnostics and fault elimination	84
5.1	LED status display	84
5.2	Diagnostics parameter	85
5.2.1	Logbook	86
5.2.2	Error history buffer	87
5.2.3	Inverter diagnostics	90
5.2.4	Network diagnostics	93
5.2.4.1	CANopen diagnostics	95
5.2.4.2	Modbus diagnostics	97
5.2.4.3	PROFIBUS diagnostics	98
5.2.4.4	EtherNet/IP diagnostics	100
5.2.4.5	PROFINET diagnostics	101
5.2.4.6	EtherCAT diagnostics	102
5.2.5	Diagnostics of the inputs and outputs	104
5.2.5.1	Digital inputs and outputs	104
5.2.5.2	Analog inputs and outputs	105
5.2.6	Wireless-LAN diagnostics	106
5.2.7	Setpoint diagnostic	107
5.2.8	Process controller status	108
5.2.9	Sequencer diagnostics	109
5.2.10	Device identification	109
5.2.11	Device overload monitoring (i*t)	111
5.2.12	Heatsink Temperature Monitoring	111
5.2.13	Life-diagnosis	112
5.3	Error handling	113
5.3.1	Error types	113
5.3.2	Error configuration	114
5.3.3	Error reset	114
5.3.4	Keypad error messages	114
5.4	Data handling	115

6	Basic setting	118
6.1	Mains voltage	119
6.2	Control source selection	121
6.3	Selection of setpoint source	122
6.3.1	Keypad setpoint default setting	125
6.4	Starting/stopping performance	126
6.4.1	Starting performance	126
6.4.2	Stopping performance	128
6.5	Frequency limits and ramp times	129
6.6	Quick stop	132
6.7	S-shaped ramps	134
6.8	Optical device identification	135

Contents

7	Motor control	136
7.1	Motor data	137
7.1.1	Manual setting of the motor data	137
7.2	Motor control selection	138
7.2.1	V/f characteristic control (VFC)	139
7.2.1.1	Linear V/f characteristic	140
7.2.1.2	Square-law V/f characteristic	141
7.2.1.3	User-definable V/f characteristic	142
7.2.1.4	V/f characteristic control - energy-saving (VFC Eco)	143
7.2.2	V/f characteristic control (VFC closed loop)	144
7.2.3	Sensorless vector control (SLVC)	145
7.2.4	Servo control for asynchronous motors (SC-ASM)	148
7.2.5	Sensorless control for synchronous motors (SL-PSM)	150
7.2.5.1	Stall monitoring	153
7.3	Optimisation of motor control	154
7.3.1	V/f voltage boost	155
7.3.2	Skip frequencies	156
7.3.3	Optimising the stalling behaviour	158
7.3.4	Slip compensation	160
7.3.5	Oscillation damping	162
7.3.6	Synchronous motor: Pole position identification (PPI)	163
7.3.6.1	Pole position identification (PPI) without movement	164
7.4	Optimisation of the control loops	165
7.4.1	Options for optimized motor tuning	168
7.4.1.1	Motor selection from motor catalogue	169
7.4.1.2	Tuning of the motor and the speed controller	170
7.4.1.3	Automatic motor identification (energized)	171
7.4.1.4	Automatic motor calibration (non-energized)	172
7.4.2	Inverter Characteristics	173
7.4.3	Motor equivalent circuit diagram data	174
7.4.4	Motor controller settings	175
7.4.4.1	Current controller	175
7.4.4.2	Field controller	176
7.4.4.3	Field weakening controller	176
7.4.4.4	Field weakening controller (advanced)	176
7.4.4.5	I _{max} controller	177
7.4.4.6	Flying restart controller	178
7.4.4.7	SLVC controller	178
7.4.4.8	Torque control w/ freq. limit	179
7.4.4.9	Slip controller	183
7.4.5	Speed controller	184
7.5	Motor rotating direction	185
7.6	Switching frequency changeover	186

7.7	Motor protection.....	187
7.7.1	Motor overload monitoring (i^2*t)	188
7.7.2	Motor temperature monitoring.....	192
7.7.3	Current limits.....	193
7.7.4	Overcurrent monitoring.....	195
7.7.5	Motor phase failure detection	196
7.7.6	Motor speed monitoring	197
7.7.7	Motor torque monitoring	197

Contents

8	Configuring the network	199
8.1	General network settings	200
8.2	Predefined process data words	219
8.2.1	Device profile CiA 402	220
8.2.2	AC Drive Profile	221
8.2.2.1	Customer specific configurations	223
8.2.3	Lenze LECOM profile	225
8.2.4	Further process data	226
8.3	Parameter access monitoring (PAM)	231
8.4	Acyclic data exchange	232
8.5	CANopen	233
8.5.1	CANopen introduction	233
8.5.2	CANopen node address	233
8.5.3	CANopen baud rate	234
8.5.4	CANopen initialisation	235
8.5.5	CANopen diagnostics	236
8.5.6	CANopen emergency telegram	237
8.5.7	CANopen heartbeat protocol	237
8.5.8	CANopen process data objects	239
8.5.9	CANopen data mapping	244
8.5.10	CANopen service data objects	247
8.5.11	CANopen error responses	248
8.5.12	CANopen diagnostic counter	250
8.5.13	CANopen LED status displays	251
8.5.14	Resetting the CANopen interface	251
8.5.15	CANopen - short setup	252
8.6	Modbus RTU	255
8.6.1	Modbus RTU introduction	255
8.6.2	Modbus RTU node address	255
8.6.3	Modbus RTU baud rate	256
8.6.4	Modbus RTU data format	256
8.6.5	Modbus RTU time-out monitoring	256
8.6.6	Modbus RTU diagnostics	257
8.6.7	Modbus RTU function codes	260
8.6.8	Modbus RTU data mapping	261
8.6.9	Modbus RTU LED status displays	265
8.6.10	Reset Modbus RTU interface	265
8.6.11	Modbus RTU response time	265
8.6.12	Short setup of Modbus RTU	266

8.7	PROFIBUS.....	267
8.7.1	PROFIBUS introduction.....	267
8.7.2	PROFIBUS communication time.....	267
8.7.3	PROFIBUS station address.....	268
8.7.4	PROFIBUS baud rate.....	268
8.7.5	PROFIBUS monitoring.....	269
8.7.6	PROFIBUS LED status displays.....	271
8.7.7	PROFIBUS diagnostics.....	271
8.7.8	PROFIBUS functions.....	272
8.7.9	PROFIBUS data mapping.....	273
8.7.10	PROFIBUS - acyclic data transfer.....	275
8.7.11	PROFIBUS - reading parameter data acyclically.....	277
8.7.12	PROFIBUS - writing parameter data acyclically.....	280
8.7.13	PROFIBUS error codes for acyclic data transfer.....	283
8.7.14	Resetting the PROFIBUS interface.....	284
8.7.15	PROFIBUS - short setup.....	285
8.8	EtherNet/IP.....	288
8.8.1	EtherNet/IP characteristics.....	289
8.8.2	EtherNet/IP configuration.....	290
8.8.3	EtherNet/IP monitoring.....	293
8.8.4	EtherNet/IP LED status displays.....	295
8.8.5	EtherNet/IP diagnostics.....	295
8.8.6	EtherNet/IP objects.....	296
8.8.7	EtherNet/IP commissioning.....	297
8.8.8	EtherNet/IP - cyclic data transfer.....	298
8.8.9	EtherNet/IP - acyclic data transfer.....	301
8.8.10	Basic drive control via EtherNet/IP.....	304
8.9	Modbus TCP/IP.....	309
8.9.1	Introduction.....	309
8.9.2	Module specification.....	309
8.9.3	Configuration.....	310
8.9.4	Time-out behaviour.....	312
8.9.5	LED status displays.....	314
8.9.6	Diagnostics.....	314
8.9.7	Modbus function codes.....	317
8.9.8	Data mapping.....	322
8.9.9	Commissioning.....	327
8.9.10	Modbus TCP/IP module.....	328
8.9.11	Drive control configuration.....	328
8.10	PROFINET.....	329
8.10.1	PROFINET introduction.....	329
8.10.2	PROFINET configuration.....	330
8.10.3	PROFINET LED status displays.....	332
8.10.4	PROFINET diagnostics.....	332
8.10.5	PROFINET monitoring.....	334
8.10.6	PROFINET data mapping.....	335
8.10.7	PROFINET - acyclic data transfer.....	339
8.10.8	Basic drive control via PROFINET.....	341

Contents

8.11	EtherCAT.....	343
8.11.1	Device identification.....	344
8.11.2	EtherCAT configuration.....	345
8.11.3	EtherCAT LED status displays.....	346
8.11.4	EtherCAT diagnostics	346
8.11.5	EtherCAT monitoring	347
8.11.6	EtherCAT objects	348
8.11.7	EtherCAT - cyclic data transfer	349
8.11.8	EtherCAT - acyclic data transfer.....	353
8.11.9	Basic drive control via EtherCAT.....	354
9	Configuring the process controller	356
9.1	Basic process controller settings	357
9.2	Process controller - idle state and rinse function.....	363
9.2.1	Process controller idle state.....	363
9.2.2	Process controller rinse function	364

10 Additional functions	365
10.1 Device Commands	366
10.1.1 Reset parameters to default	366
10.1.2 Saving/loading the parameter settings	367
10.1.3 Device commands for parameter change-over.....	369
10.1.4 Delete logbook	370
10.2 Keypad.....	371
10.2.1 Keypad language selection.....	371
10.2.2 Keypad setpoint increment.....	371
10.2.3 Keypad scaling of speed display.....	371
10.2.4 Keypad status display.....	371
10.2.5 Keypad - Configuration of R/F and CTRL buttons.....	372
10.3 Wireless LAN (WLAN).....	375
10.3.1 WLAN LED status displays	375
10.3.2 WLAN basic settings	376
10.3.2.1 Resetting WLAN settings to default setting	378
10.3.3 WLAN access point mode	379
10.3.3.1 Establishing a direct WLAN connection between smartphone and inverter.....	380
10.3.3.2 Using the smartphone as "Smart Keypad".....	381
10.3.3.3 Establishing a direct WLAN connection between Engineering PC and inverter	382
10.3.4 WLAN client mode.....	384
10.4 DC braking	386
10.4.1 Example 1: Automatic DC braking when the motor is started	388
10.4.2 Example 2: Automatic DC braking when the motor is stopped.....	389
10.5 Brake energy management	391
10.5.1 Use of a brake resistor	393
10.5.2 Stopping the deceleration ramp function generator	395
10.5.3 Inverter motor brake	396
10.6 Load loss detection	397
10.7 Access protection.....	398
10.7.1 Write access protection.....	398
10.7.1.1 Write access protection in the »EASY Starter«	400
10.7.1.2 Write access protection in the keypad	403
10.8 Favorites	407
10.8.1 Accessing the "Favorites" with the keypad.....	407
10.8.2 Favorites parameter list (default setting)	408
10.8.3 Configuring the "Favorites".....	409
10.9 Parameter change-over.....	412
10.9.1 Example: Selective control of several motors with one inverter	424
10.10 Device profile CiA 402.....	426
10.11 Holding brake control.....	429
10.11.1 Basic setting	430
10.11.2 "Automatic" brake mode (automatic operation).....	431
10.11.3 Brake holding load.....	433
10.11.4 Brake closing level	435
10.11.5 Manual release of the holding brake.....	437
10.12 Flying restart circuit	438
10.13 Timeout für fault reaction.....	440
10.14 Automatic restart.....	441

Contents

10.15	Mains failure control.....	442
10.15.1	Activating the mains failure control.....	444
10.15.2	Restart protection.....	445
10.15.3	Fast mains recovery.....	445
10.15.4	Commissioning the mains failure control.....	446
10.16	Process data.....	447
10.16.1	Position counter.....	447
10.17	Encoder settings.....	449
10.17.1	HTL encoder.....	450
10.17.2	Encoder monitoring.....	452
10.18	Firmware download.....	455
10.18.1	Firmware download via EtherCAT.....	455
10.18.2	Firmware download with »EASY Starter (Firmware loader)«.....	456
10.19	Additive voltage impression.....	457
10.19.1	Example: Using the function with a 400-V inverter.....	458
10.20	Parameter for engineering tools.....	459
11	Sequencer.....	462
11.1	Segment configuration.....	464
11.2	Sequence configuration.....	474
11.3	Sequencer basic settings.....	489
12	Safety functions.....	492
12.1	Safe torque off (STO).....	492

13 Flexible I/O configuration	493
13.1 Control source change-over	494
13.1.1 Example 1: Change-over from terminal control to keypad control	497
13.1.2 Example 2: Change-over from terminal control to network control	498
13.2 Start / stop motor	499
13.2.1 Example 1: Start/stop (1 signal) and reversal	505
13.2.2 Example 2: Start forward/start reverse/stop (edge-controlled)	506
13.2.3 Example 3: Run forward/Run reverse/stop (status-controlled)	508
13.2.4 Example 4: Quick stop	510
13.2.5 Example 5: Jog forward/Jog reverse	511
13.2.6 Example 6: Enable inverter	513
13.3 Setpoint change-over	514
13.3.1 Priority of the setpoint sources	516
13.3.2 Analog input setpoint source	516
13.3.3 Keypad setpoint source	519
13.3.4 Network setpoint source	521
13.3.5 Setpoint source of preset setpoints	522
13.3.6 Motor potentiometer setpoint source (MOP)	528
13.3.7 Setpoint source segment setpoints	532
13.3.8 HTL input setpoint source	534
13.3.8.1 Example 1: Input range 10 ... 85 kHz \equiv setting range 0 ... 50 Hz	538
13.3.8.2 Example 2: Input range 10 ... 85 kHz \equiv setting range -50 ... 50 Hz	538
13.3.8.3 Example 3: Pulse train as frequency setpoint source	539
13.4 Reset error	541
13.5 Activating DC braking manually	543
13.6 Releasing holding brake manually	545
13.7 Activating ramp 2 manually	547
13.8 Triggering a user-defined fault	549
13.9 Functions for parameter change-over	550
13.9.1 Example 1: Activation via command (only when disabled)	552
13.9.2 Example 2: Activation via command (immediately)	553
13.9.3 Example 3: Activation if the selection is changed (only if the inverter is disabled)	554
13.9.4 Example 4: Activation if the selection is changed (immediately)	555
13.10 Process controller function selection	556
13.11 Sequencer control functions	559
13.12 Frequency threshold for "Frequency threshold exceeded" trigger	564
13.13 Configuration of digital inputs	565
13.14 Configuration of analog inputs	568
13.14.1 Analog input 1	568
13.14.1.1 Example 1: Input range 0 ... 10 V \equiv setting range 0 ... 50 Hz	570
13.14.1.2 Example 2: Input range 0 ... 10 V \equiv setting range -40 ... +40 Hz	570
13.14.1.3 Example 3: Input range -10 ... +10 V \equiv setting range -40 ... +40 Hz	571
13.14.1.4 Example 4: Error detection	571
13.14.2 Analog input 2	572
13.15 Configuration of digital outputs	574
13.15.1 Relay	574
13.15.2 Digital output 1	578
13.15.3 Digital output 2	579
13.15.4 NetWordOUT1 status word	580

Contents

13.16	Configuration of analog outputs	584
13.16.1	Analog output 1.....	584
13.16.1.1	Example 1: Output voltage 0 ... 10 V \equiv output frequency 0 ... 100 Hz	585
13.16.1.2	Example 2: Output voltage 2 ... 10 V \equiv output frequency 30 ... 60 Hz	586
13.16.2	Analog output 2.....	586
14	Technical data	588
14.1	Standards and operating conditions.....	588
14.1.1	Conformities/approvals.....	588
14.1.2	Protection of persons and device protection	588
14.1.3	EMC data.....	588
14.1.4	Motor connection.....	589
14.1.5	Environmental conditions.....	589
14.1.6	Electrical supply conditions	589
14.2	1-phase mains connection 230/240 V	590
14.2.1	Rated data.....	590
14.3	1/3-phase mains connection 230/240 V.....	591
14.3.1	Rated data.....	591
14.4	3-phase mains connection 230/240 V	592
14.4.1	Rated data.....	592
14.5	3-phase mains connection 400 V	593
14.5.1	Rated data.....	593
14.6	3-phase mains connection 480 V	596
14.6.1	Rated data.....	596
15	Appendix.....	599
15.1	Operate and parameterise the inverter with keypad.....	599
15.1.1	Keypad operating mode	600
15.1.1.1	Keypad status display.....	600
15.1.1.2	Function of keypad keys in operating mode.....	601
15.1.1.3	Error reset with keypad.....	602
15.1.2	Keypad parameterisation mode.....	603
15.1.2.1	Parameter groups.....	603
15.1.2.2	Function of the keypad keys in the parameterisation mode.....	604
15.1.2.3	Save parameter settings with keypad.....	605
15.1.2.4	Display of status words on keypad	606
15.2	Error codes	607
15.3	Parameter attribute list.....	618



1 General information

1.1 Read first, then start

WARNING!

Read this documentation thoroughly before carrying out the installation and commissioning.

► Please observe the safety instructions!



Information and tools with regard to the Lenze products can be found on the Internet:

<http://www.lenze.com> → Download

Safety instructions

Basic safety measures

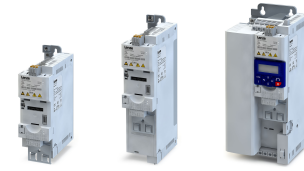

2 Safety instructions

2.1 Basic safety measures

Disregarding the following basic safety measures may lead to severe personal injury and damage to material assets!

The product

- must only be used as directed.
- must never be commissioned if they display signs of damage.
- must never be technically modified.
- must never be commissioned if they are not fully mounted.
- must never be operated without required covers.

Connect/disconnect all pluggable terminals only in deenergised condition.

Only remove the product from the installation in the deenergised state.

Insulation resistance tests between 24V control potential and PE: According to EN 61800–5–1, the maximum test voltage must not exceed 110 V DC.

Observe all specifications of the corresponding documentation supplied. This is the precondition for safe and trouble-free operation and for obtaining the product features specified.

The procedural notes and circuit details described in this document are only proposals. It is up to the user to check whether they can be adapted to the particular applications. Lenze does not take any responsibility for the suitability of the procedures and circuit proposals described.

The product must only be used by qualified personnel. IEC 60364 or CENELEC HD 384 define the skills of these persons:

- They are familiar with installing, mounting, commissioning, and operating the product.
- They have the corresponding qualifications for their work.
- They know and can apply all regulations for the prevention of accidents, directives, and laws applicable at the place of use.

Please observe the specific notes in the other chapters!

Notes used:

DANGER!

This note refers to an imminent danger which, if not avoided, may result in death or serious injury.

WARNING!

This note refers to a danger which, if not avoided, may result in death or serious injury.

CAUTION!

This note refers to a danger which, if not avoided, may result in minor or moderate injury.

NOTICE

This note refers to a danger which, if not avoided, may result in damage to property.







2.2 Residual hazards

The user must take the residual hazards mentioned into consideration in the risk assessment for his/her machine/system.

If the above is disregarded, this can lead to severe injuries to persons and damage to material assets!

Product

Observe the warning labels on the product!

Icon	Description
	Electrostatic sensitive devices: Before working on the product, the staff must ensure to be free of electrostatic charge!
	Dangerous electrical voltage Before working on the product, check if no voltage is applied to the power terminals! After mains disconnection, the power terminals carry the hazardous electrical voltage given on the product!
	High leakage current: Carry out fixed installation and PE connection in compliance with EN 61800-5-1 or EN 60204-1!
	Hot surface: Use personal protective equipment or wait until devices have cooled down!

Motor

If there is a short circuit of two power transistors, a residual movement of up to 180°/number of pole pairs can occur at the motor! (For 4-pole motor: residual movement max. $180^\circ/2 = 90^\circ$).

2.3 Application as directed

- The product must only be operated under the operating conditions prescribed in this documentation.
- The product meets the protection requirements of 2014/35/EU: Low-Voltage Directive.
- The product is not a machine in terms of 2006/42/EC: Machinery Directive.
- Commissioning or starting the operation as directed of a machine with the product is not permitted until it has been ensured that the machine meets the regulations of the EC Directive 2006/42/EC: Machinery Directive; observe EN 60204-1.
- Commissioning or starting the operation as directed is only allowed when there is compliance with the EMC Directive 2014/30/EU.
- The harmonised standard EN 61800-5-1 is used for the inverters.
- The product is not a household appliance, but is only designed as component for commercial or professional use in terms of EN 61000-3-2.
- The product can be used according to the technical data if drive systems have to comply with categories according to EN 61800-3.

In residential areas, the product may cause EMC interferences. The operator is responsible for taking interference suppression measures.



3 Mounting

3.1 Important notes

 DANGER!

Dangerous electrical voltage

Possible consequence: death or severe injuries

- ▶ All work on the inverter must only be carried out in the deenergised state.
 - ▶ After switching off the mains voltage, wait for at least 3 minutes before you start working.
-

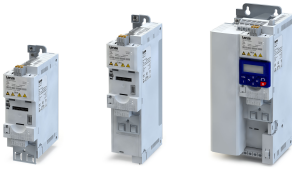

3.2 Electrical installation

3.2.1 1-phase mains connection 230/240 V

3.2.1.1 Connection plan

The wiring diagram is valid for I5xAExxxB inverters.

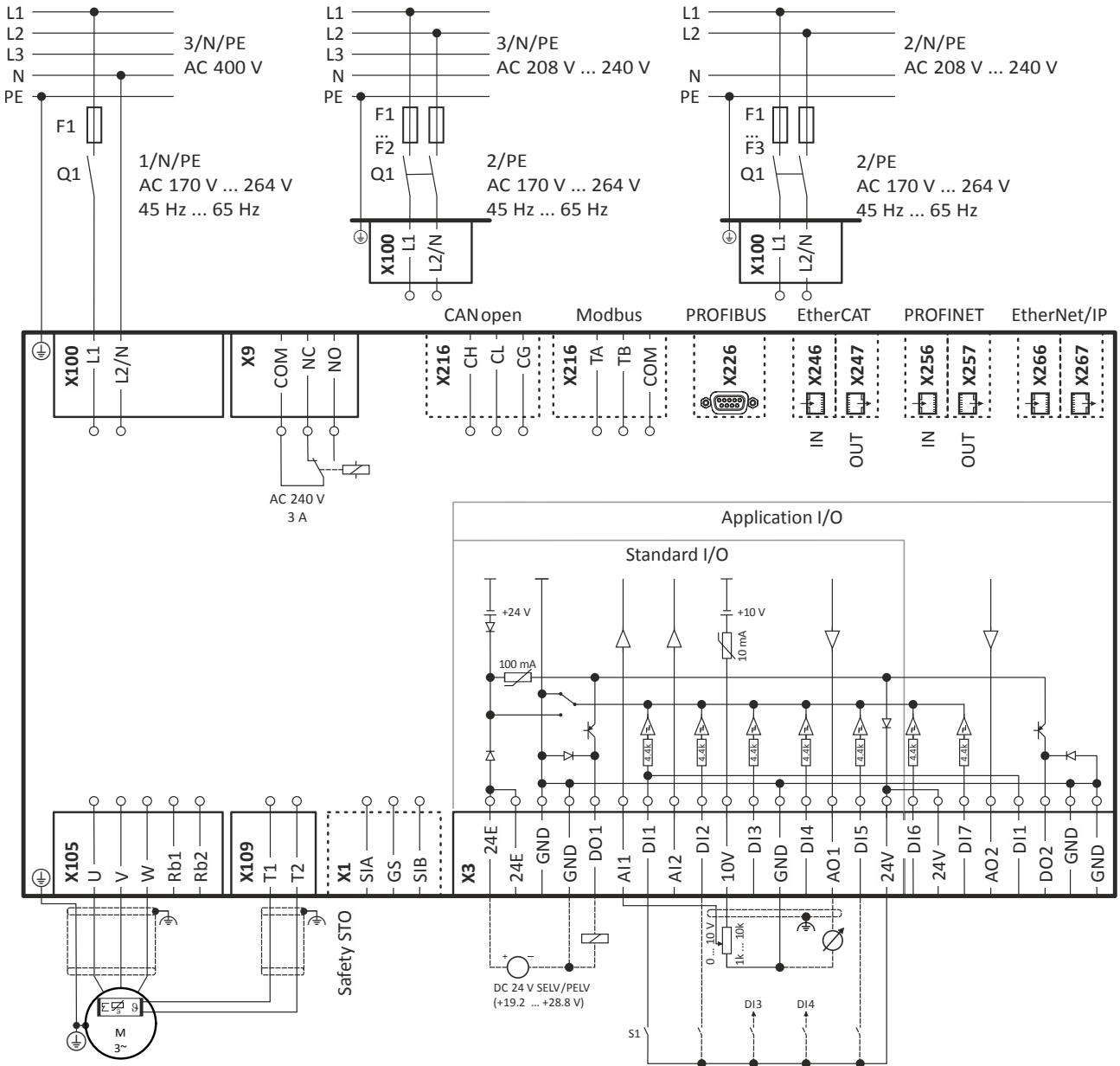

Fig. 1: Wiring example

S1 Start/Stop
Fx Fuses

Q1 Mains contactor
--- Dashed line = options

Mounting

Electrical installation

1-phase mains connection 230/240 V



3.2.1.2 Fusing and terminal data

Fuse data								
Inverter		I55AE125B	I55AE137B	I55AE155B	I55AE175B	I55AE211B	I55AE215B	I55AE222B
Cable installation in compliance with		EN 60204-1						
Laying system		B2						
operation		without mains choke						
Fuse								
Characteristics		gG/gL or gRL						
Max. rated current	A	10	10	16	16	25	25	25
Circuit breaker								
Characteristics		B						
Max. rated current	A	10	10	16	16	25	25	25
operation		with mains choke						
Fuse								
Characteristics		gG/gL or gRL						
Max. rated current	A	10	10	16	16	25	25	25
Circuit breaker								
Characteristics		B						
Max. rated current	A	10	10	16	16	25	25	25
Earth-leakage circuit breaker								
1-phase mains connection		≥ 30 mA, type A or B						

Mains connection									
Inverter		I55AE125B	I55AE137B	I55AE155B	I55AE175B	I55AE211B	I55AE215B	I55AE222B	
Connection		X100							
Connection type		pluggable screw terminal							
Min. cable cross-section	mm ²	1							
Max. cable cross-section	mm ²	2.5				6			
Stripping length	mm	8							
Tightening torque	Nm	0.5				0.7			
Required tool		0.5 x 3.0				0.6 x 3.5			
Connection		PE							
Connection type		PE screw							
Min. cable cross-section	mm ²	1							
Max. cable cross-section	mm ²	6							
Stripping length	mm	10							
Tightening torque	Nm	1.2							
Required tool		0.8 x 5.5							

Motor connection								
Inverter		I55AE125B	I55AE137B	I55AE155B	I55AE175B	I55AE211B	I55AE215B	I55AE222B
Connection		X105						
Connection type		pluggable screw terminal						
Min. cable cross-section	mm ²	1						
Max. cable cross-section	mm ²	2.5						
Stripping length	mm	8						
Tightening torque	Nm	0.5						
Required tool		0.5 x 3.0						
Connection		PE						
Connection type		PE screw						
Min. cable cross-section	mm ²	1						
Max. cable cross-section	mm ²	6						
Stripping length	mm	10						
Tightening torque	Nm	1.2						
Required tool		0.8 x 5.5						

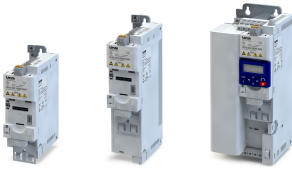

3.2.2 1/3-phase mains connection 230/240 V



I5xAExxD inverters do not have an integrated EMC filter in the AC mains supply.

In order to comply with the EMC requirements according to EN 61800-3, an external EMC filter according to IEC EN 60939 has to be used.

The user must prove that the EN 61800-3 requirements for conformity are fulfilled.

3.2.2.1 Connection plan

The wiring diagram is valid for I5xAExxD inverters.

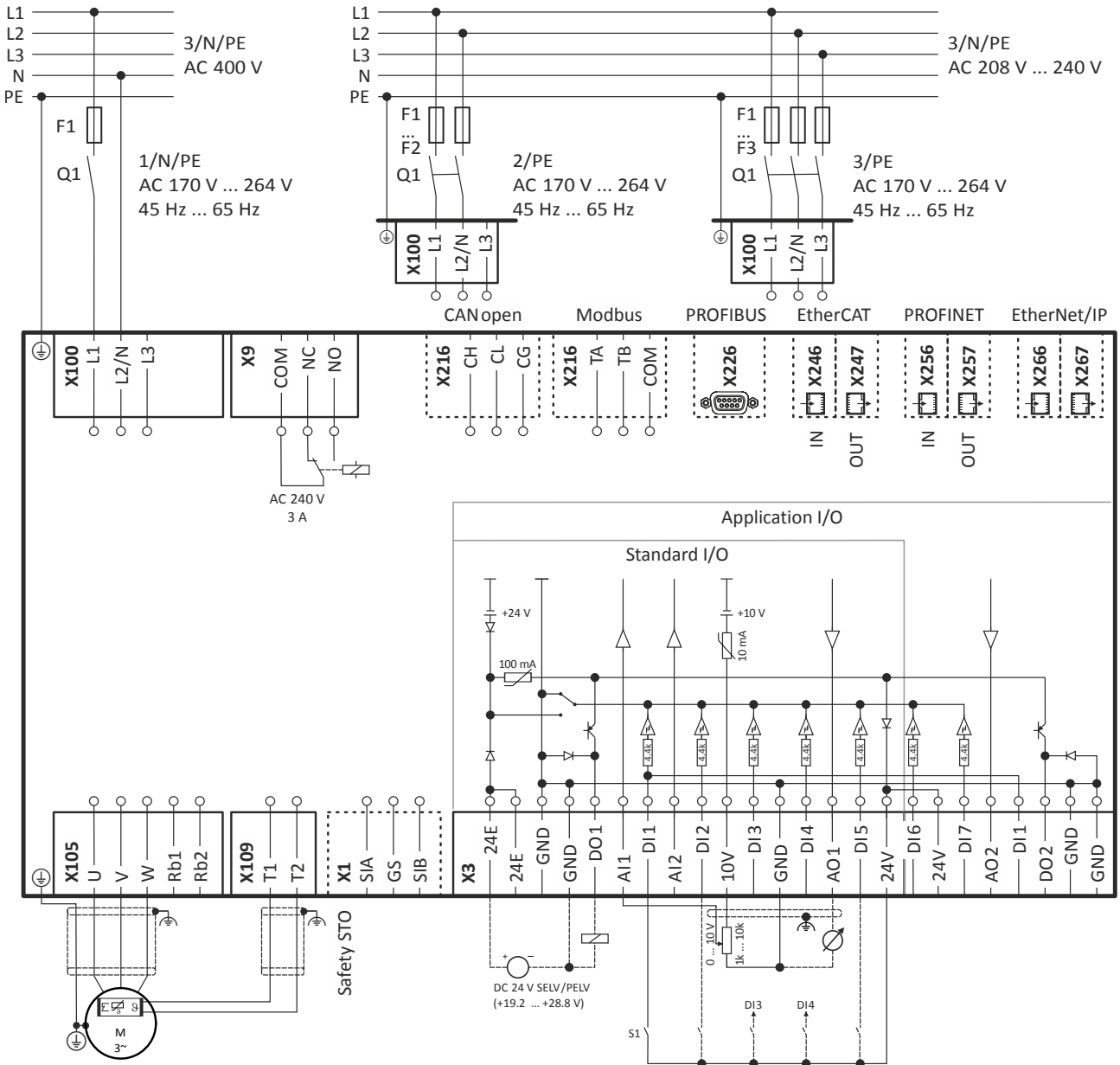

Fig. 2: Wiring example

S1 Start/Stop
Fx Fuses

Q1 Mains contactor
--- Dashed line = options

Mounting

Electrical installation

1/3-phase mains connection 230/240 V



3.2.2.2 Fusing and terminal data

Fuse data								
Inverter		I55AE125D	I55AE137D	I55AE155D	I55AE175D	I55AE211D	I55AE215D	I55AE222D
Cable installation in compliance with		EN 60204-1						
Laying system		B2						
operation		without mains choke						
Fuse								
Characteristics		gG/gL or gRL						
Max. rated current	A	10	10	16	16	25	25	25
Circuit breaker								
Characteristics		B						
Max. rated current	A	10	10	16	16	25	25	25
operation		with mains choke						
Fuse								
Characteristics		gG/gL or gRL						
Max. rated current	A	10	10	16	16	25	25	25
Circuit breaker								
Characteristics		B						
Max. rated current	A	10	10	16	16	25	25	25
Earth-leakage circuit breaker								
1-phase mains connection		≥ 30 mA, type A or B						
3-phase mains connection		≥ 30 mA, type B						

Mains connection									
Inverter		I55AE125D	I55AE137D	I55AE155D	I55AE175D	I55AE211D	I55AE215D	I55AE222D	
Connection		X100							
Connection type		pluggable screw terminal							
Min. cable cross-section	mm ²	1							
Max. cable cross-section	mm ²	2.5				6			
Stripping length	mm	8							
Tightening torque	Nm	0.5				0.7			
Required tool		0.5 x 3.0				0.6 x 3.5			
Connection		PE							
Connection type		PE screw							
Min. cable cross-section	mm ²	1							
Max. cable cross-section	mm ²	6							
Stripping length	mm	10							
Tightening torque	Nm	1.2							
Required tool		0.8 x 5.5							

Motor connection								
Inverter		I55AE125D	I55AE137D	I55AE155D	I55AE175D	I55AE211D	I55AE215D	I55AE222D
Connection		X105						
Connection type		pluggable screw terminal						
Min. cable cross-section	mm ²	1						
Max. cable cross-section	mm ²	2.5						
Stripping length	mm	8						
Tightening torque	Nm	0.5						
Required tool		0.5 x 3.0						
Connection		PE						
Connection type		PE screw						
Min. cable cross-section	mm ²	1						
Max. cable cross-section	mm ²	6						
Stripping length	mm	10						
Tightening torque	Nm	1.2						
Required tool		0.8 x 5.5						

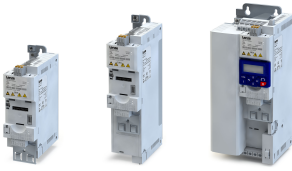

3.2.3 3-phase mains connection 230/240 V



I5xAExxxD inverters do not have an integrated EMC filter in the AC mains supply.

In order to comply with the EMC requirements according to EN 61800-3, an external EMC filter according to IEC EN 60939 has to be used.

The user must prove that the EN 61800-3 requirements for conformity are fulfilled.

3.2.3.1 Connection plan

The connection plan is valid for the I5xAExxxC inverters.

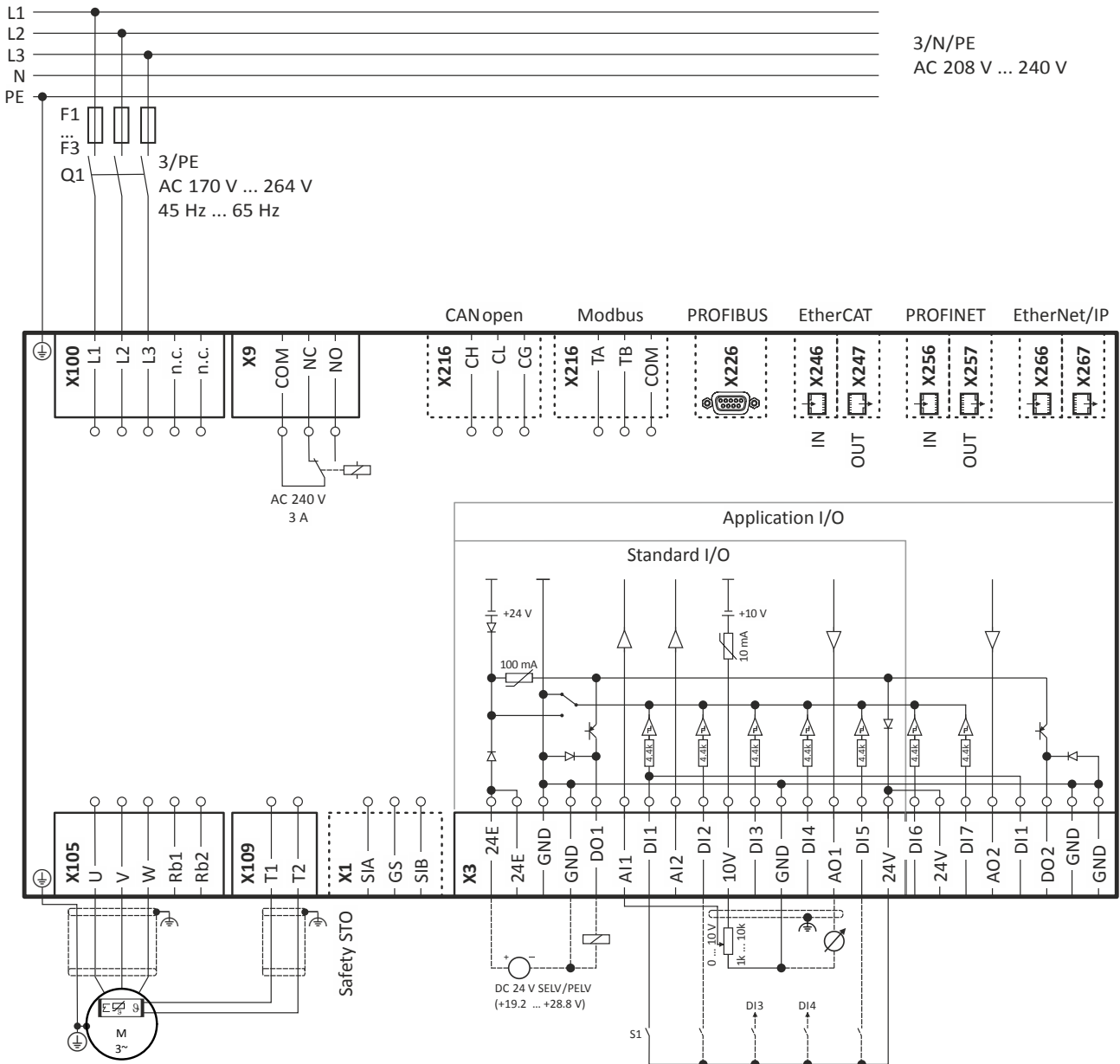

Fig. 3: Wiring example

S1 Start/Stop
Fx Fuses

Q1 Mains contactor
--- Dashed line = options

Mounting

Electrical installation
3-phase mains connection 230/240 V



3.2.3.2 Fusing and terminal data

Fuse data			
Inverter		I55AE240C	I55AE255C
Cable installation in compliance with		EN 60204-1	
Laying system		C	
operation		without mains choke	
Fuse		gG/gL or gRL	
Characteristics		gG/gL or gRL	
Max. rated current	A	32	32
Circuit breaker		B	
Characteristics		B	
Max. rated current	A	32	32
operation		with mains choke	
Fuse		gG/gL or gRL	
Characteristics		gG/gL or gRL	
Max. rated current	A	32	32
Circuit breaker		B	
Characteristics		B	
Max. rated current	A	32	32
Earth-leakage circuit breaker		≥ 300 mA, type B	
3-phase mains connection		≥ 300 mA, type B	

Mains connection			
Inverter		I55AE240C	I55AE255C
Connection		X100	
Connection type		Screw terminal	
Min. cable cross-section	mm ²	1.5	
Max. cable cross-section	mm ²	6	
Stripping length	mm	9	
Tightening torque	Nm	0.5	
Required tool		0.6 x 3.5	
Connection		PE	
Connection type		PE screw	
Min. cable cross-section	mm ²	1.5	
Max. cable cross-section	mm ²	6	
Stripping length	mm	10	
Tightening torque	Nm	1.2	
Required tool		0.8 x 5.5	

Motor connection			
Inverter		I55AE240C	I55AE255C
Connection		X105	
Connection type		Screw terminal	
Min. cable cross-section	mm ²	1.5	
Max. cable cross-section	mm ²	6	
Stripping length	mm	9	
Tightening torque	Nm	0.5	
Required tool		0.6 x 3.5	
Connection		PE	
Connection type		PE screw	
Min. cable cross-section	mm ²	1.5	
Max. cable cross-section	mm ²	6	
Stripping length	mm	10	
Tightening torque	Nm	1.2	
Required tool		0.8 x 5.5	

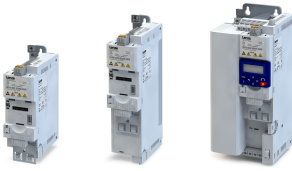

3.2.4 3-phase mains connection 400 V

3.2.4.1 Connection plan

The wiring diagram is valid for I5xAExxxF inverters.

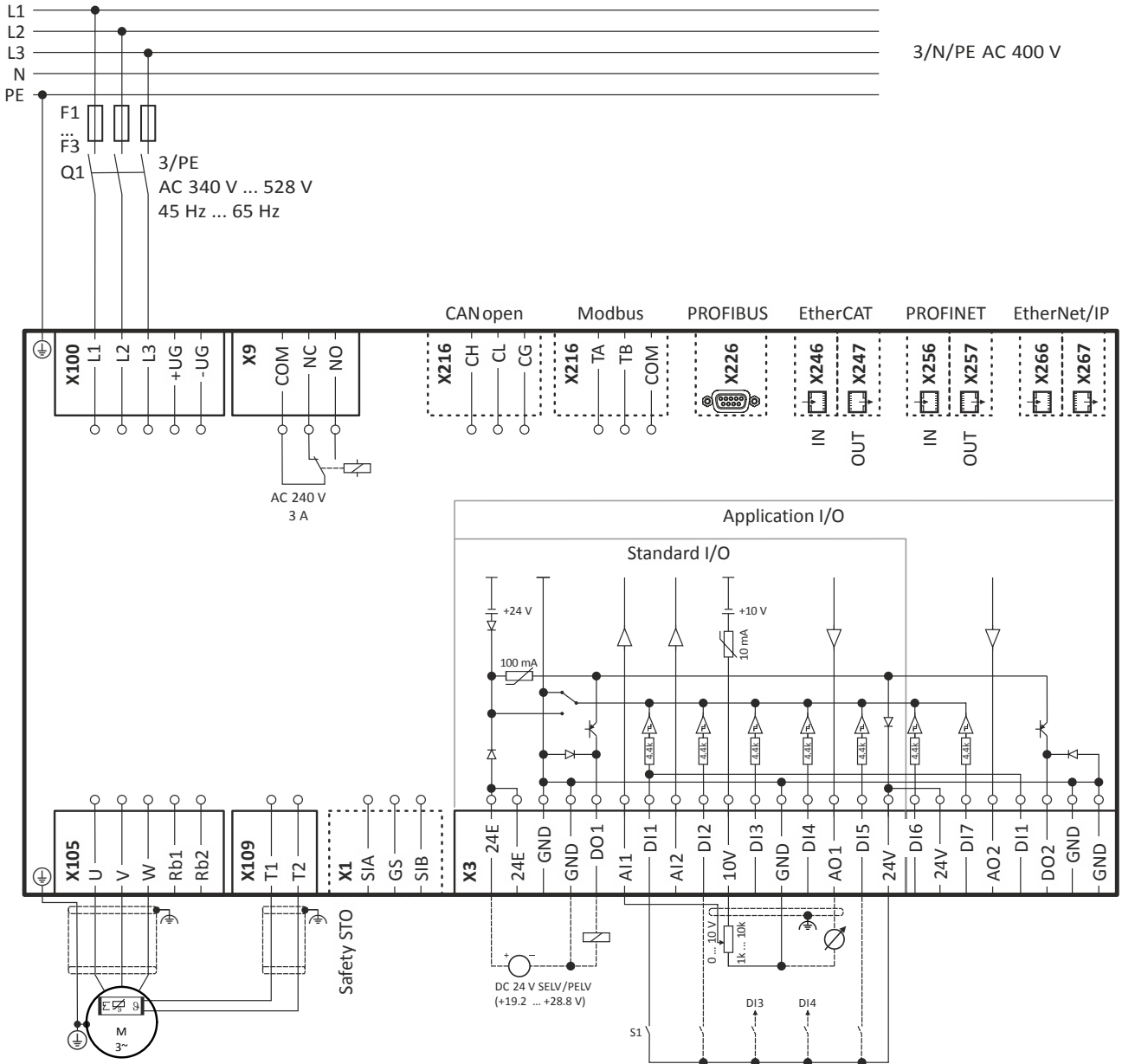

Fig. 4: Wiring example

- S1 Start/Stop
- Fx Fuses

- Q1 Mains contactor
- Dashed line = options

Mounting

Electrical installation
3-phase mains connection 400 V



3.2.4.2 Fusing and terminal data

Fuse data								
Inverter		I55AE137F	I55AE155F	I55AE175F	I55AE211F	I55AE215F	I55AE222F	I55AE230F
Cable installation in compliance with		EN 60204-1						
Laying system		B2						
operation		without mains choke						
Fuse		gG/gL or gRL						
Characteristics		gG/gL or gRL						
Max. rated current	A	10	10	10	16	16	16	25
Circuit breaker		B						
Characteristics		B						
Max. rated current	A	10	10	10	16	16	16	25
operation		with mains choke						
Fuse		gG/gL or gRL						
Characteristics		gG/gL or gRL						
Max. rated current	A	10	10	10	16	16	16	25
Circuit breaker		B						
Characteristics		B						
Max. rated current	A	10	10	10	16	16	16	25
Earth-leakage circuit breaker		≥ 30 mA, type B						
3-phase mains connection		≥ 30 mA, type B						≥ 300 mA, type B

Fuse data								
Inverter		I55AE240F	I55AE255F	I55AE275F	I55AE311F	I55AE315F	I55AE318F	I55AE322F
Cable installation in compliance with		EN 60204-1						
Laying system		B2						
operation		without mains choke						
Fuse		gG/gL or gRL						
Characteristics		gG/gL or gRL						
Max. rated current	A	25	25	32	32	63	63	-
Circuit breaker		B						
Characteristics		B						
Max. rated current	A	25	25	32	32	63	63	-
operation		with mains choke						
Fuse		gG/gL or gRL						
Characteristics		gG/gL or gRL						
Max. rated current	A	25	25	32	32	63	63	63
Circuit breaker		B						
Characteristics		B						
Max. rated current	A	25	25	32	32	63	63	63
Earth-leakage circuit breaker		≥ 300 mA, type B						
3-phase mains connection		≥ 300 mA, type B						

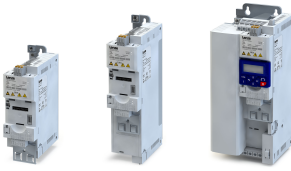

Mounting

Electrical installation
3-phase mains connection 400 V

Fuse data						
Inverter		I55AE330F	I55AE337F	I55AE345F	I55AE355F	I55AE375F
Cable installation in compliance with		EN 60204-1				
Laying system		C			F	
operation						
Fuse						
Characteristics		-				
Max. rated current	A	-	-	-	-	-
Circuit breaker						
Characteristics		-				
Max. rated current	A	-	-	-	-	-
operation		with mains choke				
Fuse						
Characteristics		gG/gL or gRL			gR	
Max. rated current	A	80	100	125	160	160
Circuit breaker						
Characteristics		B			-	
Max. rated current	A	80	100	125	-	-
Earth-leakage circuit breaker						
3-phase mains connection		≥ 300 mA, type B				

Mains connection								
Inverter		I55AE137F	I55AE155F	I55AE175F	I55AE211F	I55AE215F	I55AE222F	I55AE230F
Connection		X100						
Connection type		pluggable screw terminal						Screw terminal
Min. cable cross-section	mm ²	1						1.5
Max. cable cross-section	mm ²	2.5						6
Stripping length	mm	8						9
Tightening torque	Nm	0.5						
Required tool		0.5 x 3.0						0.6 x 3.5
Connection		PE						
Connection type		PE screw						
Min. cable cross-section	mm ²	1						1.5
Max. cable cross-section	mm ²	6						
Stripping length	mm	10						
Tightening torque	Nm	1.2						
Required tool		0.8 x 5.5						

Mains connection								
Inverter		I55AE240F	I55AE255F	I55AE275F	I55AE311F	I55AE315F	I55AE318F	I55AE322F
Connection		X100						
Connection type		Screw terminal						
Min. cable cross-section	mm ²	1.5						
Max. cable cross-section	mm ²	6		16			35	
Stripping length	mm	9		11			18	
Tightening torque	Nm	0.5		1.2			3.8	
Required tool		0.6 x 3.5		0.8 x 4.0		0.8 x 5.5		
Connection		PE						
Connection type		PE screw						
Min. cable cross-section	mm ²	1.5				4		
Max. cable cross-section	mm ²	6		16			25	
Stripping length	mm	10		11			16	
Tightening torque	Nm	1.2		3.4			4	
Required tool		0.8 x 5.5		P22				

Mounting

Electrical installation
3-phase mains connection 400 V



Mains connection						
Inverter		I55AE330F	I55AE337F	I55AE345F	I55AE355F	I55AE375F
Connection		X100				
Connection type		Screw terminal				
Min. cable cross-section	mm ²	10			25	
Max. cable cross-section	mm ²	50			95	
Stripping length	mm	19			22	
Tightening torque	Nm	4			10	
Required tool		Allen key 4.0			Allen key 6.0	
Connection		PE				
Connection type		PE screw				
Min. cable cross-section	mm ²	4				
Max. cable cross-section	mm ²	25				
Stripping length	mm	16				
Tightening torque	Nm	4				
Required tool		PZ2				

Motor connection								
Inverter		I55AE137F	I55AE155F	I55AE175F	I55AE211F	I55AE215F	I55AE222F	I55AE230F
Connection		X105						
Connection type		pluggable screw terminal						Screw terminal
Min. cable cross-section	mm ²	1						1.5
Max. cable cross-section	mm ²	2.5						6
Stripping length	mm	8						9
Tightening torque	Nm	0.5						
Required tool		0.5 x 3.0						0.6 x 3.5
Connection		PE						
Connection type		PE screw						
Min. cable cross-section	mm ²	1						1.5
Max. cable cross-section	mm ²	6						
Stripping length	mm	10						
Tightening torque	Nm	1.2						
Required tool		0.8 x 5.5						

Motor connection								
Inverter		I55AE240F	I55AE255F	I55AE275F	I55AE311F	I55AE315F	I55AE318F	I55AE322F
Connection		X105						
Connection type		Screw terminal						
Min. cable cross-section	mm ²	1.5						
Max. cable cross-section	mm ²	6	16			35		
Stripping length	mm	9	11			18		
Tightening torque	Nm	0.5	1.2			3.8		
Required tool		0.6 x 3.5	0.8 x 4.0			0.8 x 5.5		
Connection		PE						
Connection type		PE screw						
Min. cable cross-section	mm ²	1.5						4
Max. cable cross-section	mm ²	6	16			25		
Stripping length	mm	10	11			16		
Tightening torque	Nm	1.2	3.4			4		
Required tool		0.8 x 5.5	PZ2					



Mounting

Electrical installation
3-phase mains connection 400 V

Motor connection						
Inverter		I55AE330F	I55AE337F	I55AE345F	I55AE355F	I55AE375F
Connection		X105				
Connection type		Screw terminal				
Min. cable cross-section	mm ²	10			25	
Max. cable cross-section	mm ²	50			95	
Stripping length	mm	19			22	
Tightening torque	Nm	4			10	
Required tool		Allen key 4.0			Allen key 6.0	
Connection		PE				
Connection type		PE screw				
Min. cable cross-section	mm ²	4				
Max. cable cross-section	mm ²	25				
Stripping length	mm	16				
Tightening torque	Nm	4				
Required tool		PZ2				

Mounting

Electrical installation
3-phase mains connection 480 V

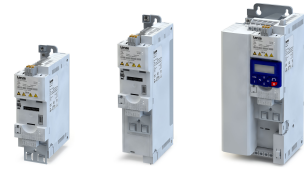

3.2.5 3-phase mains connection 480 V

3.2.5.1 Connection plan

The wiring diagram is valid for I5xAExxxF inverters.

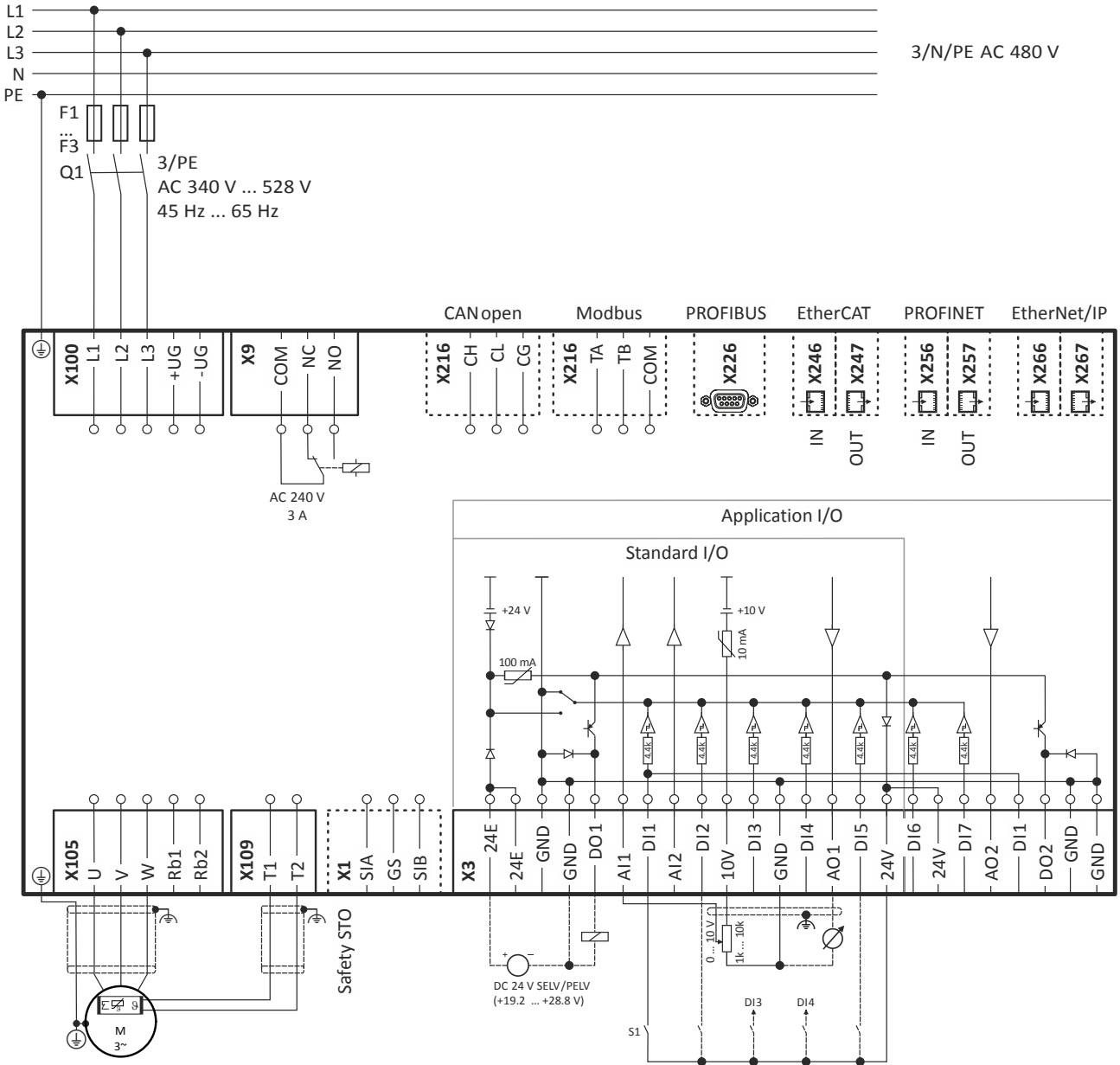
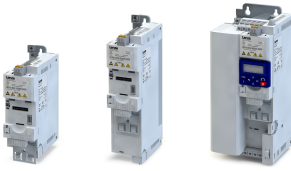

Fig. 5: Wiring example

S1 Run/Stop
Fx Fuses

Q1 Mains contactor
--- Dashed line = options



3.2.5.2 Fusing and terminal data

Fuse data								
Inverter		I55AE137F	I55AE155F	I55AE175F	I55AE211F	I55AE215F	I55AE222F	I55AE230F
Cable installation in compliance with		EN 60204-1						
Laying system		B2						
operation		without mains choke						
Fuse								
Characteristics		gG/gL or gRL						
Max. rated current	A	10	10	10	16	16	16	25
Circuit breaker								
Characteristics		B						
Max. rated current	A	10	10	10	16	16	16	25
operation		with mains choke						
Fuse								
Characteristics		gG/gL or gRL						
Max. rated current	A	10	10	10	16	16	16	25
Circuit breaker								
Characteristics		B						
Max. rated current	A	10	10	10	16	16	16	25
Earth-leakage circuit breaker								
3-phase mains connection		≥ 30 mA, type B						≥ 300 mA, type B

Fuse data								
Inverter		I55AE240F	I55AE255F	I55AE275F	I55AE311F	I55AE315F	I55AE318F	I55AE322F
Cable installation in compliance with		EN 60204-1						
Laying system		B2						
operation		without mains choke						
Fuse								
Characteristics		gG/gL or gRL						
Max. rated current	A	25	25	32	32	63	63	63
Circuit breaker								
Characteristics		B						
Max. rated current	A	25	25	32	32	63	63	63
operation		with mains choke						
Fuse								
Characteristics		gG/gL or gRL						
Max. rated current	A	25	25	32	32	63	63	63
Circuit breaker								
Characteristics		B						
Max. rated current	A	25	25	32	32	63	63	63
Earth-leakage circuit breaker								
3-phase mains connection		≥ 300 mA, type B						

Mounting

Electrical installation
3-phase mains connection 480 V



Fuse data						
Inverter		I55AE330F	I55AE337F	I55AE345F	I55AE355F	I55AE375F
Cable installation in compliance with		EN 60204-1				
Laying system		C			F	
operation						
Fuse						
Characteristics		-				
Max. rated current	A	-	-	-	-	-
Circuit breaker						
Characteristics		-				
Max. rated current	A	-	-	-	-	-
operation		with mains choke				
Fuse						
Characteristics		gG/gL or gRL			gR	
Max. rated current	A	80	100	125	160	160
Circuit breaker						
Characteristics		B			-	
Max. rated current	A	80	100	125	-	-
Earth-leakage circuit breaker						
3-phase mains connection		≥ 300 mA, type B				

Mains connection								
Inverter		I55AE137F	I55AE155F	I55AE175F	I55AE211F	I55AE215F	I55AE222F	I55AE230F
Connection		X100						
Connection type		pluggable screw terminal						Screw terminal
Min. cable cross-section	mm ²	1						1.5
Max. cable cross-section	mm ²	2.5						6
Stripping length	mm	8						9
Tightening torque	Nm	0.5						
Required tool		0.5 x 3.0						0.6 x 3.5
Connection		PE						
Connection type		PE screw						
Min. cable cross-section	mm ²	1						1.5
Max. cable cross-section	mm ²	6						
Stripping length	mm	10						
Tightening torque	Nm	1.2						
Required tool		0.8 x 5.5						

Mains connection								
Inverter		I55AE240F	I55AE255F	I55AE275F	I55AE311F	I55AE315F	I55AE318F	I55AE322F
Connection		X100						
Connection type		Screw terminal						
Min. cable cross-section	mm ²	1.5						
Max. cable cross-section	mm ²	6		16			35	
Stripping length	mm	9		11			18	
Tightening torque	Nm	0.5		1.2			3.8	
Required tool		0.6 x 3.5		0.8 x 4.0		0.8 x 5.5		
Connection		PE						
Connection type		PE screw						
Min. cable cross-section	mm ²	1.5				4		
Max. cable cross-section	mm ²	6		16			25	
Stripping length	mm	10		11			16	
Tightening torque	Nm	1.2		3.4			4	
Required tool		0.8 x 5.5		P22				

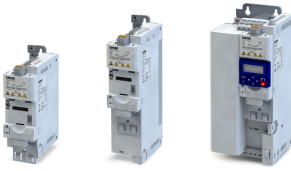

Mounting

Electrical installation
3-phase mains connection 480 V

Mains connection						
Inverter		I55AE330F	I55AE337F	I55AE345F	I55AE355F	I55AE375F
Connection		X100				
Connection type		Screw terminal				
Min. cable cross-section	mm ²	10			25	
Max. cable cross-section	mm ²	50			95	
Stripping length	mm	19			22	
Tightening torque	Nm	4			10	
Required tool		Allen key 4.0			Allen key 6.0	
Connection		PE				
Connection type		PE screw				
Min. cable cross-section	mm ²	4				
Max. cable cross-section	mm ²	25				
Stripping length	mm	16				
Tightening torque	Nm	4				
Required tool		PZ2				

Motor connection								
Inverter		I55AE137F	I55AE155F	I55AE175F	I55AE211F	I55AE215F	I55AE222F	I55AE230F
Connection		X105						
Connection type		pluggable screw terminal						Screw terminal
Min. cable cross-section	mm ²	1						1.5
Max. cable cross-section	mm ²	2.5						6
Stripping length	mm	8						9
Tightening torque	Nm	0.5						
Required tool		0.5 x 3.0						0.6 x 3.5
Connection		PE						
Connection type		PE screw						
Min. cable cross-section	mm ²	1						1.5
Max. cable cross-section	mm ²	6						
Stripping length	mm	10						
Tightening torque	Nm	1.2						
Required tool		0.8 x 5.5						

Motor connection								
Inverter		I55AE240F	I55AE255F	I55AE275F	I55AE311F	I55AE315F	I55AE318F	I55AE322F
Connection		X105						
Connection type		Screw terminal						
Min. cable cross-section	mm ²	1.5						
Max. cable cross-section	mm ²	6	16			35		
Stripping length	mm	9	11			18		
Tightening torque	Nm	0.5	1.2			3.8		
Required tool		0.6 x 3.5	0.8 x 4.0			0.8 x 5.5		
Connection		PE						
Connection type		PE screw						
Min. cable cross-section	mm ²	1.5					4	
Max. cable cross-section	mm ²	6	16			25		
Stripping length	mm	10	11			16		
Tightening torque	Nm	1.2	3.4			4		
Required tool		0.8 x 5.5	PZ2					

Mounting

Electrical installation
3-phase mains connection 480 V



Motor connection						
Inverter		I55AE330F	I55AE337F	I55AE345F	I55AE355F	I55AE375F
Connection		X105				
Connection type		Screw terminal				
Min. cable cross-section	mm ²	10			25	
Max. cable cross-section	mm ²	50			95	
Stripping length	mm	19			22	
Tightening torque	Nm	4			10	
Required tool		Allen key 4.0			Allen key 6.0	
Connection		PE				
Connection type		PE screw				
Min. cable cross-section	mm ²	4				
Max. cable cross-section	mm ²	25				
Stripping length	mm	16				
Tightening torque	Nm	4				
Required tool		P22				

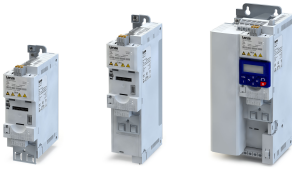

3.2.6 CANopen

Typical topologies

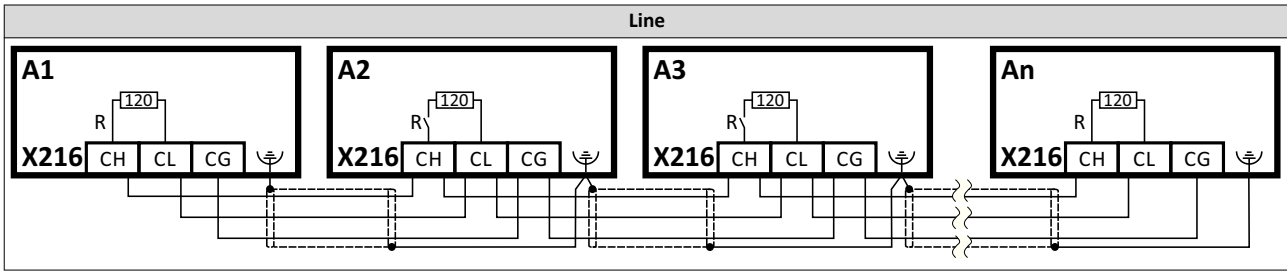

Terminal description	CANopen	
Connection	X216	
Connection type	pluggable spring terminal	
Min. cable cross-section	mm ²	0.5
Max. cable cross-section	mm ²	2.5
Stripping length	mm	10
Tightening torque	Nm	-
Required tool	0.4 x 2.5	

Basic network settings

Use the DIP switch to set the node address and baud rate and to activate the integrated bus terminating resistor.

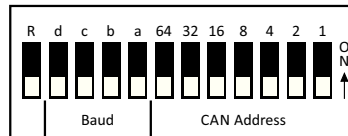

Bus termination	Baud rate				CAN node address													
R	d	c	b	a	64	32	16	8	4	2	1							
OFF	OFF	ON	OFF	ON	20 kbps							OFF	OFF	OFF	OFF	OFF	OFF	OFF
Inactive	OFF	OFF	ON	ON	50 kbps							Value from parameter						
ON	OFF	OFF	ON	OFF	125 kbps							Node address - example:						
Active	OFF	OFF	OFF	ON	250 kbps							OFF	OFF	ON	OFF	ON	ON	ON
	OFF	OFF	OFF	OFF	Value from parameter (500 kbps)							Node address = 16 + 4 + 2 + 1 = 23						
	OFF	ON	OFF	OFF	1 Mbps													
	All other combinations				Value from parameter (500 kbps)													

Bold print = default setting



The network must be terminated with a 120 Ω resistor at the physically first and last node.

Set the "R" switch to ON at these nodes.

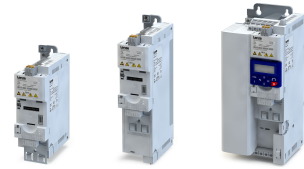

3.2.7 Modbus RTU

Typical topologies

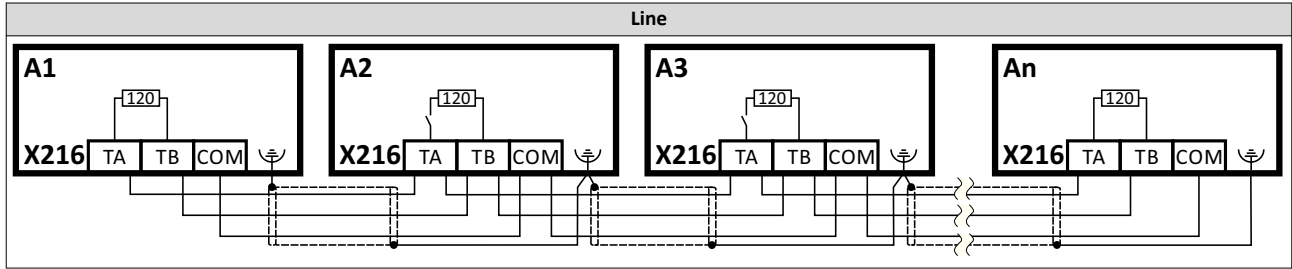

Terminal description		Modbus
Connection		X216
Connection type		pluggable spring terminal
Min. cable cross-section	mm ²	0.5
Max. cable cross-section	mm ²	2.5
Stripping length	mm	10
Tightening torque	Nm	-
Required tool		0.4 x 2.5

Basic network settings

Use the DIP switch to set the node address and baud rate and to activate the integrated bus terminating resistor.

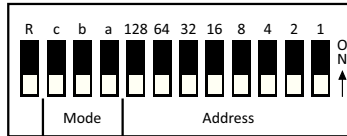

Bus termination		Baud rate	Parity	Modbus node address							
R	c	b	a	128	64	32	16	8	4	2	1
OFF	n.c.	OFF	OFF	OFF	OFF	OFF	OFF	OFF	OFF	OFF	OFF
Inactive		Automatic detection	Automatic detection	Value from parameter							
ON		ON	ON	Node address - example:							
Active		Value from parameter	Value from parameter	OFF	OFF	OFF	ON	OFF	ON	ON	ON
				Node address = 16 + 4 + 2 + 1 = 23							
				Node address > 247: value from parameter							

Bold print = default setting



The network must be terminated with a 120 Ω resistor at the physically first and last node.

Set the "R" switch to ON at these nodes.



3.2.8 Modbus TCP

Typical topologies

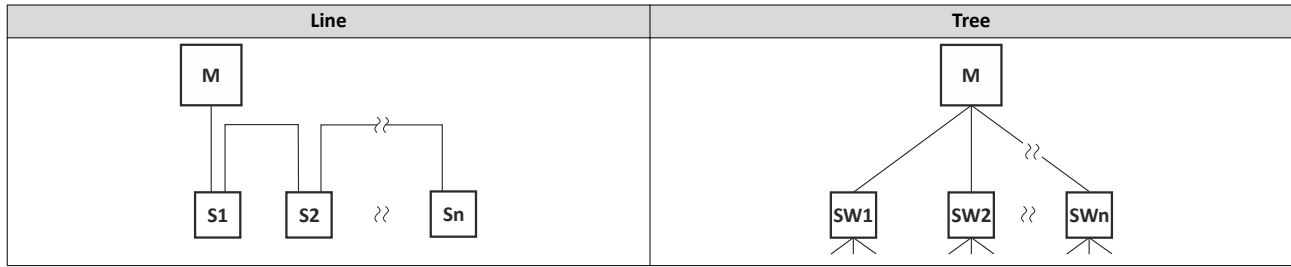

M Master
S Slave

SW Switch

Basic network settings

The rotary encoder switch allows you to set the last byte of the IP address.

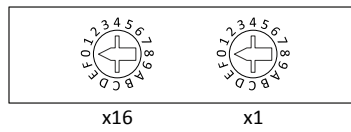

Setting	Value of last byte	Resulting IP address
0x00	Value from parameter	Value from parameter
0x01 ... 0xFE	Switch position	192.168.124.<switch position>
0xFF	Default setting	192.168.124.16



3.2.9 PROFIBUS

Typical topologies

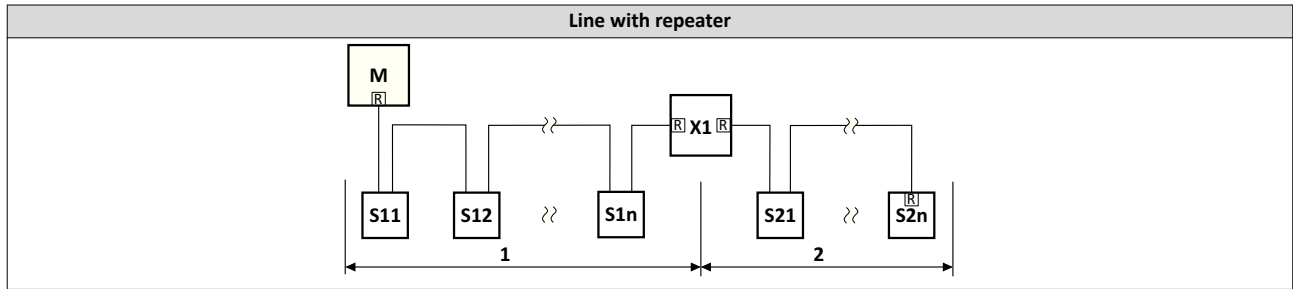

M Master
S Slave
X Repeater
R Activated bus terminating resistor

Basic network settings

Use the DIP switch to set the station address.

The baud rate is detected automatically.

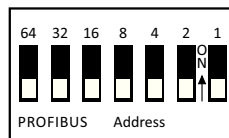

PROFIBUS station address						
64	32	16	8	4	2	1
OFF	OFF	OFF	OFF	OFF	OFF	OFF
Value from parameter						
Station address - example:						
OFF	OFF	ON	OFF	ON	ON	ON
Station address = 16 + 4 + 2 + 1 = 23						
Do not set station address = 126 and station address = 127. These station addresses are invalid.						

Bold print = default setting



The network must be terminated with a resistor at the physically first and last node.

Activate the bus terminating resistor at these nodes in the bus connection plug.



3.2.10 EtherCAT

Typical topologies

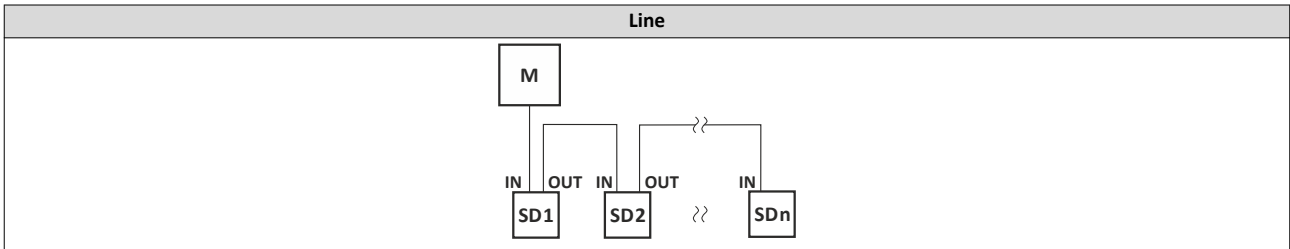

M Master
SD Slave Device

Basic network settings

The rotary encoder switch allows you to set an EtherCAT identifier.

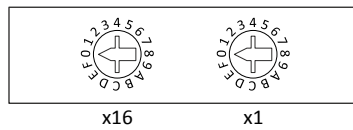

Setting	Identifier
0x00	Value from parameter
0x01 ... 0xFF	Switch position

3.2.11 EtherNet/IP

Typical topologies

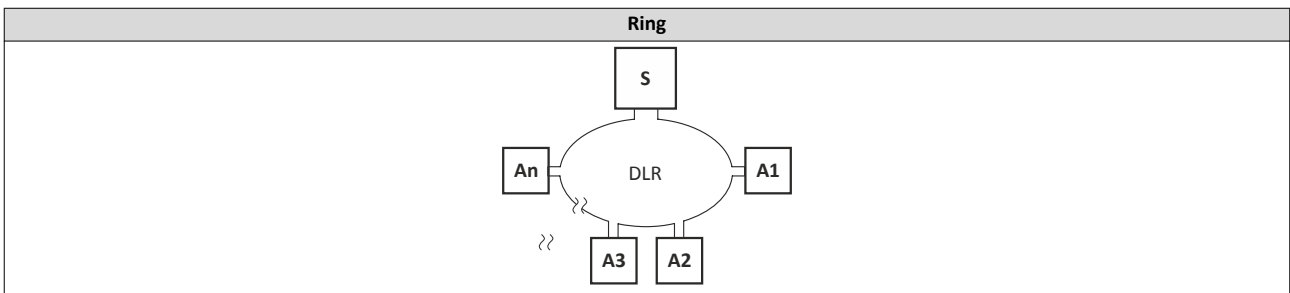
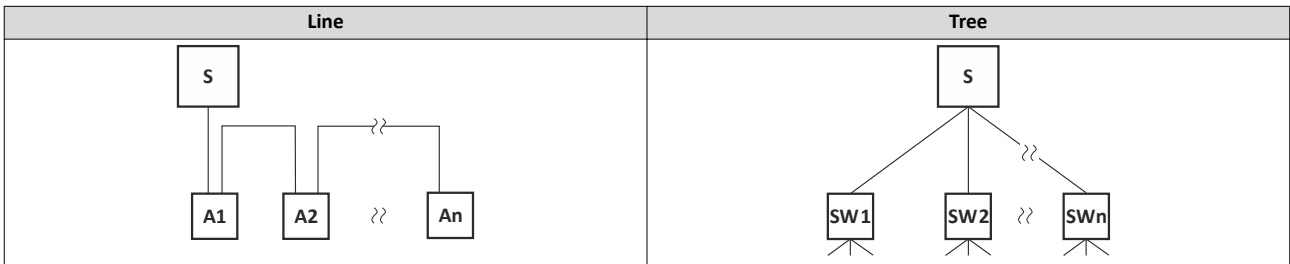

S Scanner
A Adapter
SW Switch

Basic network settings

The rotary encoder switch allows you to set the last byte of the IP address.

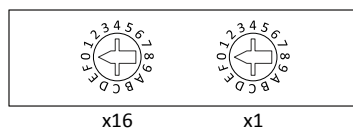

Setting	Value of last byte	Resulting IP address
0x00	Value from parameter	Value from parameter
0x01 ... 0xFE	Switch position	192.168.124.<switch position>
0xFF	Default setting	192.168.124.16



3.2.12 PROFINET

Typical topologies

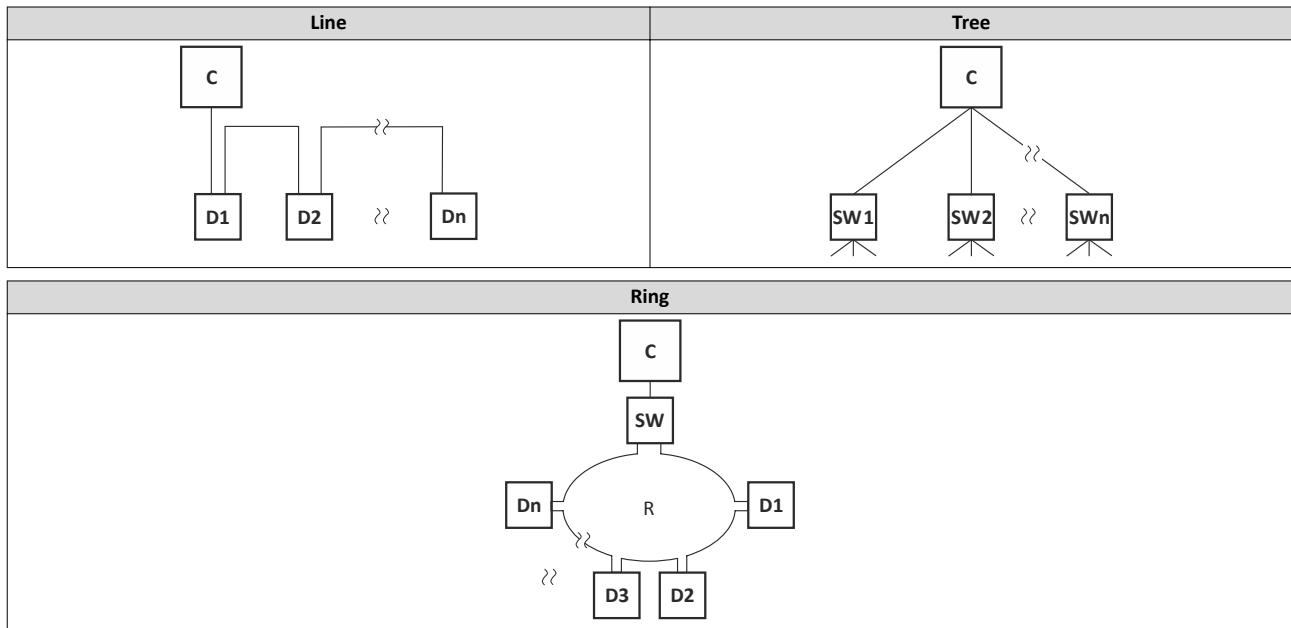

C IO controller
D IO device
SW Switch SCALANCE (MRP capable)
R Redundant domain



The rotary encoder switch has no function.

3.2.13 Connection of the safety module

3.2.13.1 Terminal data

Terminal description		Safety STO
Connection		X1
Connection type		pluggable spring terminal
Min. cable cross-section	mm ²	0.5
Max. cable cross-section	mm ²	1.5
Stripping length	mm	9
Tightening torque	Nm	-
Required tool		0.4 x 2.5



4 Commissioning

4.1 Important notes

WARNING!

Incorrect wiring can cause unexpected states during the commissioning phase.

Possible consequence: death, severe injuries or damage to property

Check the following before switching on the mains voltage:

- ▶ Is the wiring complete and correct?
 - ▶ Are there no short circuits and earth faults?
 - ▶ Is the motor circuit configuration (star/delta) adapted to the output voltage of the inverter?
 - ▶ Is the motor connected in-phase (direction of rotation)?
 - ▶ Does the "emergency stop" function of the entire plant operate correctly?
-

WARNING!

Incorrect settings during commissioning may cause unexpected and dangerous motor and system movements.

Possible consequence: death, severe injuries or damage to property

- ▶ Clear hazardous area.
 - ▶ Observe safety instructions and safety clearances.
-

Commissioning

Operating interfaces
Keypad

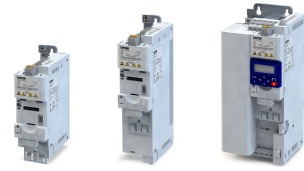

4.2 Operating interfaces

Commissioning the inverter requires an operator-process interface.

4.2.1 Keypad

The keypad is an easy means for the local operation, parameterisation, and diagnostics of the inverter.



- The keypad is simply connected to the diagnostic interface on the front of the inverter.
- The keypad can also be connected and removed during operation.

Detailed information on the keypad can be found in the appendix:

▶ [Operate and parameterise the inverter with keypad](#)  599

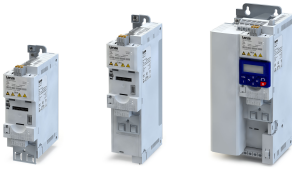

4.2.2 Engineering tool »EASY Starter«

The »EASY Starter« is a PC software that is especially designed for the commissioning and maintenance of the inverter.



The »EASY Starter« PC software can be found on the Internet:
<http://www.lenze.com> → Download → Software Downloads

Sample screenshot:

The screenshot displays the EASY Starter V1.8.0.6156 software interface. The main window is titled "EASY Starter V1.8.0.6156 - i550 CAN application IO 50 Hz - Diagnosis-Adapter - My Device". The interface is divided into several sections:

- Left Panel:** Shows the device tree with "Type: i550 CAN application IO 50 Hz", "Address path: Diagnosis-Adapter", "Name: My Device", "Version: 1.0.1.0", "Bus server: Lenze OPC Diagnostics Serv", and "Device description: i550_CAN_application_IO_0".
- Settings Tab:** Contains sub-tabs for "Settings", "Diagnosis", "Parameter list", and "Trend". The "Settings" sub-tab is active, showing the "Actuating Speed Overview".
- Basic Setup:**
 - Rated mains voltage: 230Veff [0]
 - Rotation restriction: Forward and reverse [1]
 - Default frequency setpoint: Analog input 1 [2]
 - Start method: Normal [0]
 - Start on Power up: Off [0]
 - Stop method: Standard Ramp [1]
- Motor Control:**
 - Designation: 0
 - Motor control mode: VFC open loop [6]
 - Motor rated current: 1.420 A
 - Rated speed: 1450 rpm
 - Rated frequency: 50.0 Hz
 - Rated voltage: 230 V
 - Rated cosine phi: 0.80
- Function & I/O Setup:**
 - Minimum frequency: 0.0 Hz
 - Maximum frequency: 50.0 Hz
 - Acceleration time 1: 5.0 s
 - Deceleration time 1: 5.0 s
 - Quickstop deceleration time: 1.0 s
 - Preset bit0 selection: Digital input 4 [14]
 - Preset bit1 selection: Digital input 5 [15]
 - Inverter enable: TRUE [1]
 - Quick stop: Not connected [0]
 - Run forward (CW): Not connected [0]
 - Run reverse (CCW): Not connected [0]
 - Preset 1: 20.0 Hz
 - Preset 2: 40.0 Hz
 - Preset 3: 50.0 Hz
- Controller inhibit set:** A row of checkboxes for various inhibit signals: DC link circuit volta., Actual motor current, Actual motor voltage, v1 velocity actual va., Actual frequency, Status words: L402., Error code.
- Bottom Panel:** Displays real-time monitoring data:
 - DC link circuit volta.: 0 V
 - Actual motor current: 0.0 A
 - Actual motor voltage: 0 VAC
 - v1 velocity actual va.: 0 rpm
 - Actual frequency: 0.0 Hz
 - Status words: L402.: Initial [0]
 - Error code: No Error [0]
 - Drag&Drop Parameter button

Commissioning

Operating interfaces
Engineering tool »EASY Starter«

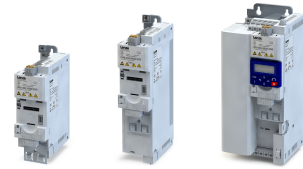

4.2.2.1 Generate a connection between inverter and »EASY Starter«

For commissioning the inverter with the »EASY Starter«, a communication link with the inverter is required. This can be established in a wired or wireless manner via WLAN.

Preconditions

- For the wired communication with the inverter, the USB module and a USB 2.0 cable (A plug on Micro-B plug) are required.



- For the wireless communication with the inverter, the WLAN module is required. Moreover, the PC on which the »EASY Starter« is installed must be wireless-enabled.





Details

The following instructions describe the connection establishment via the USB module.

- Parameterising without motor operation does not require a mains voltage: If you connect the inverter directly to the PC without a hub, The USB interface of the PC is sufficient for the voltage supply.
- Instructions for the connection establishment via the WLAN module can be found in the chapter "Wireless LAN (WLAN)". [375](#)

How to establish a communication to the inverter via USB:

Preconditions for commissioning:

- The functional test described in the mounting and switch-on instructions has been completed successfully (without any errors or faults).
- The inverter is ready for operation (mains voltage is switched on).

Accessories required for commissioning:

- USB module
- USB 2.0 cable (A-plug on micro B-plug)
- PC with installed »EASY Starter« software

1. Plug the USB module onto the front of the inverter (interface X16).
2. Use a USB cable to connect the inverter to the PC on which »EASY Starter« is installed:
 - a) Plug the micro B plug of the USB cable into the socket of the USB module.
 - b) Plug the other end into a free USB type A-socket of the PC.

3. Start »EASY Starter«.

The "Add devices" dialog is shown.

4. Select the "USB - USB via adapter i5MADU0000000S" connection:

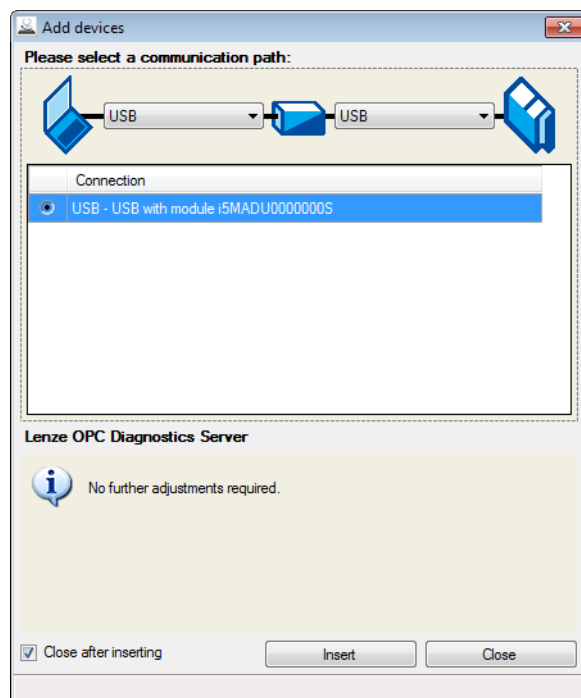

5. Click the **Insert** button.

»EASY Starter« searches for connected devices via the communication path selected. When the connection has been established successfully, the inverter is displayed in the device list of »EASY Starter«. The inverter parameters can now be accessed via the tabs of »EASY Starter«.

Commissioning

Parameter setting
Engineering tool »EASY Starter«



4.3 Parameter setting

As a part of a machine with a speed-variable drive system, the inverter must be adapted to its drive task. The adaptation process of the inverter is carried out by changing parameters. Optionally these parameters can be accessed by means of the keypad or »EASY Starter«. If the inverter is provided with a network option, access can also be effected by a higher-level Controller via the corresponding network.



Certain device commands or settings which might cause a critical state of the drive behaviour can only be carried out when the inverter is inhibited.



4.3.1 General notes on parameters

Each parameter features a 16-bit index as address. Under this address, the parameter is stored in the object directory of the inverter.

- Parameters that belong together functionally are combined in a data set. These parameters are additionally provided with an 8-bit subindex.
- The colon is used as a separator between the index and subindex Example: "0x2540:001"
- There are parameters the setting of which can be changed, and (diagnostic) parameters which can only be read.

Parameterisation using the keypad

- All parameters which can be accessed by means of the keypad are provided with a "Display code", the first digit of the display code specifying the group in which the parameter can be found on the keypad.
- In the documentation, the display code — if available — is specified in brackets behind the address. Example: "0x2915 (P210.00)".

► [Keypad parameterisation mode](#) [603](#)

Structure of the parameter descriptions in this documentation

- The parameter descriptions in this documentation are structured in table form.
- The representation distinguishes parameters with a setting range, text, selection list, and bit-coded display.
- The default setting of parameters with a write access feature is shown in **bold**.
- The display code as well as the short keypad designation of the parameter which is limited to 16 characters, are — if available — shown in brackets.

Example: parameters with a setting range

Parameter	Name / value range / [default setting]	Info
Index:Subindex (display code)	Parameter designation (abbreviated keypad designation) Minimum value ... [default setting] ... maximum value • Optional information with regard to the parameter.	Explanations & notes with regard to the parameter.

Example: parameters with a selection list

Parameter	Name / value range / [default setting]	Info
Index:Subindex (display code)	Parameter designation (abbreviated keypad designation) • Optional information with regard to the parameter.	Explanations & notes with regard to the parameter. Note: The corresponding selection number (here 0, 1, or 2) must be set. Other values are not permissible.
	0 Designation of selection 0	Optionally: Explanations & notes with regard to the corresponding selection.
	1 Designation of selection 1	The default selection is shown in bold .
	2 Designation of selection 2	

Example: parameters with a bit-coded display

Parameter	Name / value range / [default setting]	Info
Index:Subindex (display code)	Parameter designation (abbreviated keypad designation) • Optional information with regard to the parameter.	Explanations & notes with regard to the parameter.
	Bit 0 Designation of bit 0	Optionally: Explanations & notes with regard to the corresponding bit.
	Bit 1 Designation of bit 1	
	Bit 2 Designation of bit 2	
	
	Bit 15 Designation of bit 15	

Parameter overview lists in this documentation

- [Keypad parameter list](#): for the parameterisation using the keypad, contains a list of all parameters which can also be accessed by means of the keypad. [55](#)
- [Parameter attribute list](#): contains a list of all inverter parameters. This list in particular includes some information that is relevant for the reading and writing of parameters via the network. [618](#)

Commissioning

Parameter setting
Basic inverter settings



4.3.2 Basic inverter settings

Check the following basic settings of the inverter and adapt them, if required.

Parameter	Name / value range / [default setting]	Info
0x2540:001 (P208.01)	Mains settings: Rated mains voltage (Mains settings: Mains voltage) • Setting can only be changed if the inverter is inhibited.	Selection of the mains voltage for actuating the inverter.
	0 230 Veff	
	1 400 Veff	
	2 480 Veff	
	10 230 Veff/reduced LU level	
0x2838:001 (P203.01)	Start/stop configuration: Start method (Start/stop cfg: Start method) • Setting can only be changed if the inverter is inhibited.	Behaviour after start command.
	0 Normal	After start command, the standard ramps are active. • Acceleration time 1 can be set in 0x2917 (P220.00) . • Deceleration time 1 can be set in 0x2918 (P221.00) .
	1 DC braking	After start command, the "DC braking" function is active for the time set in 0x2B84:002 (P704.02) . ▶ DC braking □ 386
	2 Flying restart circuit	After the start command, the flying restart circuit is active. The flying restart function makes it possible to restart a coasting motor during operation without speed feedback. Synchronicity between the inverter and motor is coordinated so that the transition to the rotating motor is effected without jerk at the time of connection. ▶ Flying restart circuit □ 438
0x2838:002 (P203.02)	Start/stop configuration: Start at power-up (Start/stop cfg: Start at powerup)	Starting performance after switching on the mains voltage.
	0 Off	No automatic start after switching on mains voltage. In addition to the inverter enable, a renewed start command is always required to start the motor.
	1 On	Automatic start of the motor after switching on the mains voltage if the inverter is enabled and a start command exists.
0x2838:003 (P203.03)	Start/stop configuration: Stop method (Start/stop cfg: Stop method)	Behaviour after the "Stop" command.
	0 Coasting	The motor becomes torqueless (coasts down to standstill).
	1 Standard ramp	The motor is brought to a standstill with deceleration time 1 (or deceleration time 2, if activated). • Deceleration time 1 can be set in 0x2918 (P221.00) . • Deceleration time 2 can be set in 0x291A (P223.00) . ▶ Frequency limits and ramp times □ 129
	2 Quick stop ramp	The motor is brought to a standstill with the deceleration time set for the "Quick stop" function. • Deceleration time for quick stop can be set in 0x291C (P225.00) . • The "quick stop" function can also be activated manually, for instance via a digital input. ▶ Quick stop □ 132
0x283A (P304.00)	Limitation of rotation (Limit. rotation)	Optional restriction of the rotating direction.
	0 Only clockwise (CW)	The motor can only be rotated clockwise (CW). The transfer of negative frequency and PID setpoints to the motor control is prevented. • This function takes effect after the "Invert rotation" function (0x2631:013 (P400.13)). • Since this function only prevents negative setpoints, counter-clockwise rotation (CCW) is possible if the motor has been wired for this rotating direction.
	1 Both rotation directions	Both directions of motor rotation are enabled.



Commissioning

Parameter setting Basic inverter settings

Parameter	Name / value range / [default setting]	Info
0x2860:001 (P201.01)	Frequency control: Default setpoint source (Std. setpoints: Freq. setp. src.)	Selection of the standard setpoint source for operating mode "MS: Velocity mode". <ul style="list-style-type: none"> The selected standard setpoint source is always active in the operating mode 0x6060 (P301.00) = "MS: Velocity mode [-2]" when no setpoint change-over to another setpoint source via corresponding triggers/functions is active. <ul style="list-style-type: none"> ▶ Setpoint change-over □ 514
	1 Keypad	The setpoint is specified locally by the keypad. <ul style="list-style-type: none"> Default setting: 0x2601:001 (P202.01) Use the ↑ and ↓ navigation keys to change the keypad setpoint (also during running operation).
	2 Analog input 1	The setpoint is defined as analog signal via the analog input 1. <ul style="list-style-type: none"> ▶ Analog input 1 □ 568
	3 Analog input 2	The setpoint is defined as analog signal via the analog input 2. <ul style="list-style-type: none"> ▶ Analog input 2 □ 572
	4 HTL input (from version 04.00)	The digital inputs DI3 and DI4 can be configured as HTL input to use an HTL encoder as setpoint encoder or define the setpoint as a reference frequency ("pulse train"). <ul style="list-style-type: none"> ▶ HTL input setpoint source □ 534
	5 Network	The setpoint is defined as process data object via the network. <ul style="list-style-type: none"> ▶ Configuring the network □ 199
	11 Frequency preset 1	For the setpoint selection, preset values can be parameterised and selected. <ul style="list-style-type: none"> ▶ Setpoint source of preset setpoints □ 522
	12 Frequency preset 2	
	13 Frequency preset 3	
	14 Frequency preset 4	
	15 Frequency preset 5	
	16 Frequency preset 6	
	17 Frequency preset 7	
	18 Frequency preset 8	
	19 Frequency preset 9	
	20 Frequency preset 10	
	21 Frequency preset 11	
	22 Frequency preset 12	
	23 Frequency preset 13	
	24 Frequency preset 14	
	25 Frequency preset 15	
	31 Segment preset 1 (from version 03.00)	For the setpoint selection, the segment presets parameterised for the "sequencer" function can be selected as well. <ul style="list-style-type: none"> ▶ Sequencer □ 462
	32 Segment preset 2 (from version 03.00)	
	33 Segment preset 3 (from version 03.00)	
	34 Segment preset 4 (from version 03.00)	
35 Segment preset 5 (from version 03.00)		
36 Segment preset 6 (from version 03.00)		
37 Segment preset 7 (from version 03.00)		
38 Segment preset 8 (from version 03.00)		
50 Motor potentiometer	The setpoint is generated by the "motor potentiometer" function. This function can be used as an alternative setpoint control which is controlled via two signals: "MOP setpoint up" and "MOP setpoint down". <ul style="list-style-type: none"> ▶ Motor potentiometer setpoint source (MOP) □ 528 	
0x2911:001 (P450.01)	Frequency setpoint presets: Preset 1 (Freq. presets: Freq. preset 1) 0.0 ... [20.0] ... 599.0 Hz	Parameterisable frequency setpoints (presets) for operating mode "MS: Velocity mode".
0x2911:002 (P450.02)	Frequency setpoint presets: Preset 2 (Freq. presets: Freq. preset 2) 0.0 ... [40.0] ... 599.0 Hz	
0x2911:003 (P450.03)	Frequency setpoint presets: Preset 3 (Freq. presets: Freq. preset 3) Device for 50-Hz mains: 0.0 ... [50.0] ... 599.0 Hz Device for 60-Hz mains: 0.0 ... [60.0] ... 599.0 Hz	

Commissioning

Parameter setting
Basic motor settings



Parameter	Name / value range / [default setting]	Info
0x2915 (P210.00)	Minimum frequency (Min. frequency) 0.0 ... [0.0] ... 599.0 Hz	Lower limit value for all frequency setpoints.
0x2916 (P211.00)	Maximum frequency (Max. frequency) Device for 50-Hz mains: 0.0 ... [50.0] ... 599.0 Hz Device for 60-Hz mains: 0.0 ... [60.0] ... 599.0 Hz	Upper limit value for all frequency setpoints.
0x2917 (P220.00)	Acceleration time 1 (Accelerat.time 1) 0.0 ... [5.0] ... 3600.0 s	Acceleration time 1 for the operating mode "MS: Velocity mode". <ul style="list-style-type: none"> The acceleration time set refers to the acceleration from standstill to the maximum frequency set. In the case of a lower setpoint selection, the actual acceleration time is reduced accordingly. Setting is not effective in the operating mode 0x6060 (P301.00) = "CiA: Velocity mode [2]". ▶ Device profile CiA 402 □ 426
0x2918 (P221.00)	Deceleration time 1 (Decelerat.time 1) 0.0 ... [5.0] ... 3600.0 s	Deceleration time 1 for the operating mode "MS: Velocity mode". <ul style="list-style-type: none"> The deceleration time set refers to the deceleration from the maximum frequency set to standstill. In the case of a lower actual frequency, the actual deceleration time is reduced accordingly. Setting is not effective in the operating mode 0x6060 (P301.00) = "CiA: Velocity mode [2]". ▶ Device profile CiA 402 □ 426
0x291C (P225.00)	Quick stop deceleration time (QSP dec. time) 0.0 ... [1.0] ... 3600.0 s	Quick stop deceleration time for the operating mode "MS: Velocity mode". <ul style="list-style-type: none"> If the "Quick stop" function is activated, the motor is brought to a standstill within the deceleration time set here. The deceleration time set refers to the deceleration from the maximum frequency set to standstill. In the case of a lower actual frequency, the actual deceleration time is reduced accordingly. Setting is not effective in the operating mode 0x6060 (P301.00) = "CiA: Velocity mode [2]". ▶ Device profile CiA 402 □ 426

All possible basic settings are described in the "[Basic setting](#)" chapter. □ 118

4.3.3 Basic motor settings

Check the following default settings for the motor and motor control and adapt them, if required.

Drive behaviour by default

By default, the V/f characteristic control with a linear characteristic is preset as motor control for asynchronous motors. The V/f characteristic control is a motor control for conventional frequency inverter applications. It is based on a simple and robust control mode for the operation of asynchronous motors with a linear or square-law load torque characteristic (e.g. fan). Because of the minimal parameterisation effort, such applications can be commissioned easily and quickly.

The default settings of the parameters ensure that the inverter is ready for operation immediately and the motor works adequately without further parameterisation if an inverter and an asynchronous motor* Hz asynchronous machine with matching performances are assigned to each other.

* Depending on the device/mains frequency either 50-Hz asynchronous motor or 60-Hz asynchronous motor.

Parameter	Name / value range / [default setting]	Info
0x2B01:001 (P303.01)	V/f shape data: Base voltage (V/f shape data: Base voltage) 0 ... [230]* ... 5000 V * Default setting depending on the size.	Base voltage and base frequency define the V/f ratio and thus the gradient of the V/f characteristic. <ul style="list-style-type: none"> The V/f base voltage is usually set to the rated motor voltage 0x2C01:007 (P320.07).
0x2B01:002 (P303.02)	V/f shape data: Base frequency (V/f shape data: Base frequency) Device for 50-Hz mains: 0 ... [50]* ... 1500 Hz Device for 60-Hz mains: 0 ... [60]* ... 1500 Hz * Default setting depending on the size.	<ul style="list-style-type: none"> The V/f base frequency is usually set to the rated motor frequency 0x2C01:005 (P320.05).



Commissioning

Parameter setting
Basic motor settings

Parameter	Name / value range / [default setting]	Info
0x2C00 (P300.00)	Motor control mode (Motor ctrl mode) • Setting can only be changed if the inverter is inhibited.	Selection of the motor control type.
	2 Servo control (SC ASM) (from version 02.00)	This control mode is used for servo control of an asynchronous motor. • Control mode is possible up to a rated power of maximally 45 kW. ▶ Servo control for asynchronous motors (SC-ASM) 148
	3 Sensorless control (SL PSM) (from version 02.00)	This control type is used for the sensorless control of a synchronous motor. • Control mode is possible up to a rated power of maximally 45 kW. ▶ Sensorless control for synchronous motors (SL-PSM) 150
	4 Sensorless vector control (SLVC)	This control type is used for sensorless vector control of an asynchronous motor. • Control mode is possible up to a rated power of maximally 45 kW. ▶ Sensorless vector control (SLVC) 145
	6 V/f characteristic control (VFC open loop)	This control mode is used for the speed control of an asynchronous motor via a V/f characteristic and is the simplest control mode. ▶ V/f characteristic control (VFC) 139
	7 V/f characteristic control (VFC closed loop) (from version 04.00)	The control mode is used for speed control of an asynchronous motor via a V/f characteristic with speed feedback. A motor encoder must be connected to the inverter and set as feedback system for the motor control. ▶ V/f characteristic control (VFC closed loop) 144
0x2C01:010	Motor parameters: Motor name	The name (e.g. "1") can be freely selected by the user. If the motor in the engineering tool has been selected from the "motor catalog", the respective motor name is automatically entered here (example: "MDSKA080-22, 70").
0x6075 (P323.00)	Motor rated current (Motor current) 0.001 ... [1.700]* ... 500.000 A * Default setting depending on the size. • Setting can only be changed if the inverter is inhibited.	The rated motor current to be set here serves as a reference value for different parameters with a setting/display of a current value in percent. Example: • Motor rated current = 1.7 A • Max current 0x6073 (P324.00) = 200 % Motor rated current = 3.4 A

All possible settings with regard to the motor and motor control are described in the "[Motor control](#)" chapter. [136](#)

Commissioning

Parameter setting
Function assignment of the inputs and outputs



4.3.4 Function assignment of the inputs and outputs

The inverter control can be adapted individually to the respective application. This is basically effected by assigning digital control sources ("triggers") to functions of the inverter.

By default, the inverter can be controlled via the I/O terminals as follows:

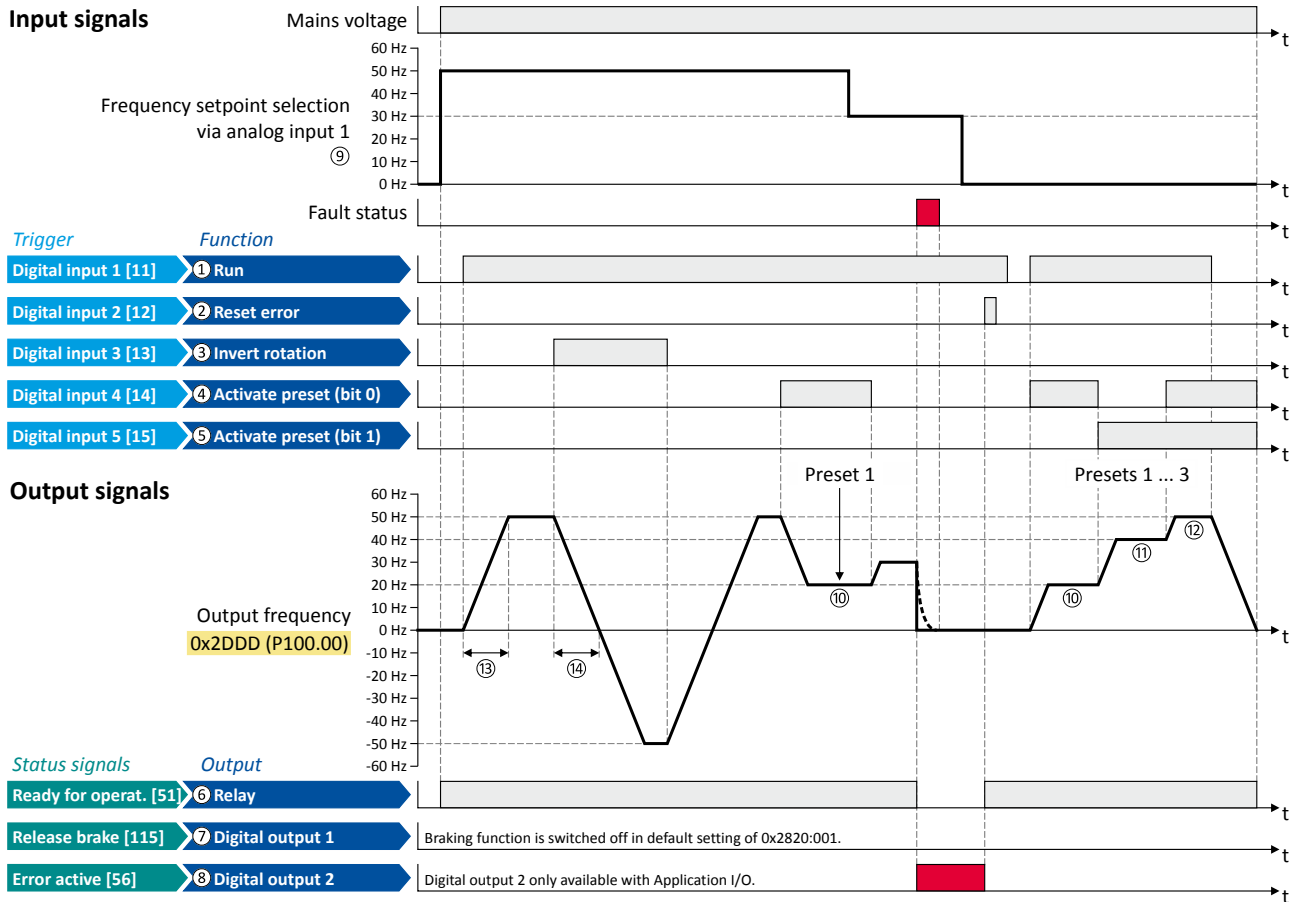

Parameter	Name	Default setting
Control functions		
①	0x2631:002 (P400.02)	Run
②	0x2631:004 (P400.04)	Reset fault
③	0x2631:013 (P400.13)	Invert rotation
④	0x2631:018 (P400.18)	Activate preset (bit 0)
⑤	0x2631:019 (P400.19)	Activate preset (bit 1)
Configuration of digital outputs		
⑥	0x2634:001 (P420.01)	Relay
⑦	0x2634:002 (P420.02)	Digital output 1
⑧	0x2634:003 (P420.03)	Digital output 2 (only for application I/O)
Settings for the frequency setpoint		
⑨	0x2860:001 (P201.01)	Frequency control: Default setpoint source
⑩	0x2911:001 (P450.01)	Frequency setpoint presets: Preset 1
⑪	0x2911:002 (P450.02)	Frequency setpoint presets: Preset 2
⑫	0x2911:003 (P450.03)	Frequency setpoint presets: Preset 3
⑬	0x2917 (P220.00)	Acceleration time 1
⑭	0x2918 (P221.00)	Deceleration time 1



Commissioning

Parameter setting

Function assignment of the inputs and outputs

Parameter	Name / value range / [default setting]	Info
0x2631:002 (P400.02)	Function list: Run (Function list: Run) <ul style="list-style-type: none"> Setting can only be changed if the inverter is inhibited. For further possible settings, see parameter 0x2631:001 (P400.01). 500 	Assignment of a trigger for the "Run" function. Function 1: Start / stop motor (default setting) Function 1 is active if no further start commands (start forward/start reverse) have been connected to triggers, no keypad control is active and no network control is active. Trigger = TRUE: Let motor rotate forward (CW). Trigger = FALSE: Stop motor. Notes to function 1: <ul style="list-style-type: none"> If "Enable inverter" 0x2631:001 (P400.01) is set = "Constant TRUE [1]", the only permissible trigger for this function is a digital input in order that the motor can be stopped again any time. The stop method can be selected in 0x2838:003 (P203.03). The function also serves to realise an automatic start after switch-on. <ul style="list-style-type: none"> ▶ Starting performance 126 Function 2: Start enable/stop motor Function 2 is active if further start commands have been connected to triggers, keypad control is active or network control is active. Trigger = TRUE: Start commands of the active control source are enabled. Trigger = FALSE: Stop motor. Notes to function 2: <ul style="list-style-type: none"> If no separate start enable is required for the application, the trigger "Constant TRUE [1]" must be set. The stop method can be selected in 0x2838:003 (P203.03).
	11 Digital input 1	State of X3/DI1, taking an inversion set in 0x2632:001 (P411.01) into consideration.
0x2631:004 (P400.04)	Function list: Reset fault (Function list: Reset fault) <ul style="list-style-type: none"> For further possible settings, see parameter 0x2631:001 (P400.01). 500 	Assignment of a trigger for the "Reset fault" function. Trigger = FALSE↗TRUE (edge): Active error is reset (acknowledged) if the error condition is not active anymore and the error is resettable. Trigger = FALSE: no action.
	12 Digital input 2	State of X3/DI2, taking an inversion set in 0x2632:002 (P411.02) into consideration.
0x2631:013 (P400.13)	Function list: Invert rotation (Function list: Invert rotation) <ul style="list-style-type: none"> Setting can only be changed if the inverter is inhibited. For further possible settings, see parameter 0x2631:001 (P400.01). 500 	Assignment of a trigger for the "Invert rotation" function. Trigger = TRUE: the setpoint specified is inverted (i. e. the sign is inverted). Trigger = FALSE: no action / deactivate function again.
	13 Digital input 3	State of X3/DI3, taking an inversion set in 0x2632:003 (P411.03) into consideration.
0x2631:018 (P400.18)	Function list: Activate preset (bit 0) (Function list: Setp: Preset b0) <ul style="list-style-type: none"> For further possible settings, see parameter 0x2631:001 (P400.01). 500 	Assignment of a trigger for the "Activate preset (bit 0)" function. Selection bit with the valency 20 for the bit-coded selection and activation of a parameterised setpoint (preset value). Trigger = FALSE: selection bit = "0". Trigger = TRUE: selection bit = "1".
	14 Digital input 4	State of X3/DI4, taking an inversion set in 0x2632:004 (P411.04) into consideration.
0x2631:019 (P400.19)	Function list: Activate preset (bit 1) (Function list: Setp: Preset b1) <ul style="list-style-type: none"> For further possible settings, see parameter 0x2631:001 (P400.01). 500 	Assignment of a trigger for the "Activate preset (bit 1)" function. Selection bit with the valency 21 for the bit-coded selection and activation of a parameterised setpoint (preset value). Trigger = FALSE: selection bit = "0". Trigger = TRUE: selection bit = "1".
	15 Digital input 5	State of X3/DI5, taking an inversion set in 0x2632:005 (P411.05) into consideration.

Commissioning

Parameter setting

Function assignment of the inputs and outputs

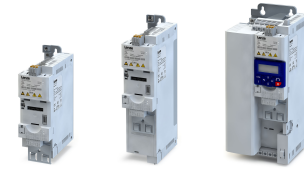

Parameter	Name / value range / [default setting]	Info
0x2634:001 (P420.01)	Digital outputs function: Relay (Dig.out.function: Relay function) <ul style="list-style-type: none"> For further possible settings, see parameter 0x2634:001 (P420.01). 493 	Assignment of a trigger to the relay. Trigger = FALSE: X9/NO-COM open and NC-COM closed. Trigger = TRUE: X9/NO-COM closed and NC-COM open. Notes: <ul style="list-style-type: none"> An inversion set in 0x2635:001 (P421.01) is taken into consideration here.
	51 Ready for operation	TRUE if inverter is ready for operation (no error active, no STO active and DC-bus voltage ok). Otherwise FALSE.
0x2634:002 (P420.02)	Digital outputs function: Digital output 1 (Dig.out.function: DO1 function) <ul style="list-style-type: none"> For further possible settings, see parameter 0x2634:001 (P420.01). 493 	Assignment of a trigger to digital output 1. Trigger = FALSE: X3/DO1 set to LOW level. Trigger = TRUE: X3/DO1 set to HIGH level. Notes: <ul style="list-style-type: none"> An inversion set in 0x2635:002 (P421.02) is taken into consideration here.
	115 Release holding brake	Trigger signal for releasing the holding brake (TRUE = release holding brake). Note! If this trigger is assigned to the relay or a digital output, the deceleration times set for the respective output are not effective (are internally set to "0"). Only the deceleration time set in 0x2820:012 (P712.12) for closing the holding brake influences in this case the time-dependent behaviour of the output. ▶ Holding brake control 429
0x2634:003 (P420.03)	Digital outputs function: Digital output 2 (Dig.out.function: DO2 function) <ul style="list-style-type: none"> Only available for application I/O. For further possible settings, see parameter 0x2634:001 (P420.01). 493 	Assignment of a trigger to digital output 2. Trigger = FALSE: X3/DO2 set to LOW level. Trigger = TRUE: X3/DO2 set to HIGH level. Notes: <ul style="list-style-type: none"> An inversion set in 0x2635:003 (P421.03) is taken into consideration here.
	56 Error active	TRUE if error is active. Otherwise FALSE.

All functional possible settings for controlling the inverter are described in the "[Flexible I/O configuration](#)" chapter. [493](#)



4.4 Keypad parameter list

For commissioning or diagnostics using the keypad, all parameters of the inverter that can also be accessed by means of the keypad are listed in the following "Keypad parameter list".

- The keypad parameter list is sorted in ascending order in compliance with the "display code" (Pxxx).
- In order to provide for quick access, all parameters of the inverter are divided into different groups according to their function.
- Group 0 contains the configurable "Favorites". In the default setting these are the most common parameters for the solution of typical applications. ▶ [Favorites](#) [407](#)
- Based on the hundreds digit of the display code (Pxxx) you can quickly see in which group the parameter is to be found on the keypad:

Parameter	Group - name	Description
P1xx	Group 1 - Diagnostics	Diagnostic/display parameters for displaying device-internal process factors, current actual values, and status messages. ▶ Diagnostics parameter 85
P2xx	Group 2 - Basic setting	Setting of the mains voltage, selection of the control and setpoint source, starting and stopping performance, frequency limits and ramp times. ▶ Basic setting 118
P3xx	Group 3 - Motor control	Configuration of the motor and motor control ▶ Motor control 136
P4xx	Group 4 - I/O setting	Function assignment and configuration of the inputs and outputs ▶ Flexible I/O configuration 493
P5xx	Group 5 - Network setting	Configuration of the network (if available) ▶ Configuring the network 199
P6xx	Group 6 - Process controller	Configuration of the process controller ▶ Configuring the process controller 356
P7xx	Group 7 - Additional functions	Parameterisable additional functions ▶ Additional functions 365
P8xx	Group 8 - Sequencer	The "sequencer" function serves to define a programmed sequence of speed setpoints, PID setpoints or torque setpoints for the motor control. Switching to the next setpoint can be executed in a time-based or event-based manner. ▶ Sequencer 462



A complete overview of all parameter indexes can be found in the annex in the [Parameter attribute list](#). [618](#)

Frequently used abbreviations in the short keypad designations of the parameters:

Abbreviation	Meaning
AI	Analog input
AO	Analog output
BO, B1, ...	Bit 0, bit 1, ...
CU	Control unit
DI	Digital input
DO	Digital output
LU	Undervoltage
MOP	Motor potentiometer
NET	Network
OU	overvoltage
PID	Process controller
PU	Power unit
QSP	Quick stop
Setp	Setpoint
WD	Watchdog

Commissioning

Keypad parameter list



How to read the keypad parameter list:

Column	Meaning
Display code	Parameter number on the keypad. Format: Number.Subindex
Short designation	Short keypad designation limited to 16 characters.
Default setting	Default setting of the parameter.
Setting range	Possible setting range for the parameter. Format: minimum value ... maximum value [unit]
Address	Address of the parameter in the object directory. Format: Index:Subindex
Category	Functional assignment of the parameter, for example "motor control" or "CANopen".

Keypad parameter list (short overview of all parameters with display code)

Display code	Short designation	Default setting	Setting range	Address	Category
P100.00	Output frequency	x.x Hz	- (Read only)	0x2DDD	general
P101.00	Scaled act value	x Units	- (Read only)	0x400D	general
P102.00	Freq. setpoint	x.x Hz	- (Read only)	0x2B0E	general
P103.00	Current actual	x.x %	- (Read only)	0x6078	general
P104.00	Motor current	x.x A	- (Read only)	0x2D88	general
P105.00	DC-bus voltage	x V	- (Read only)	0x2D87	general
P106.00	Motor voltage	x VAC	- (Read only)	0x2D89	general
P107.00	Torque actual	x.x %	- (Read only)	0x6077	general
P108.xx	Output power				
L P108.01	Effective power	x.xxx kW	- (Read only)	0x2DA2:001	general
L P108.02	Apparent power	x.xxx kVA	- (Read only)	0x2DA2:002	general
P109.xx	Output energy				
L P109.01	Motor	x.xx kWh	- (Read only)	0x2DA3:001	general
L P109.02	Generator	x.xx kWh	- (Read only)	0x2DA3:002	general
P110.xx	AI1 diagnostics				
L P110.01	AI1 terminal %	x.x %	- (Read only)	0x2DA4:001	general
L P110.02	AI1 scaled freq.	x.x Hz	- (Read only)	0x2DA4:002	general
L P110.03	AI1 scaled PID	x.xx PID unit	- (Read only)	0x2DA4:003	general
L P110.04	AI1 scaled torq.	x.x %	- (Read only)	0x2DA4:004	general
L P110.16	AI1 status	-	- (Read only)	0x2DA4:016	general
P111.xx	AI2 diagnostics				
L P111.01	AI2 terminal %	x.x %	- (Read only)	0x2DA5:001	general
L P111.02	AI2 scaled freq.	x.x Hz	- (Read only)	0x2DA5:002	general
L P111.03	AI2 scaled PID	x.xx PID unit	- (Read only)	0x2DA5:003	general
L P111.04	AI2 scaled torq.	x.x %	- (Read only)	0x2DA5:004	general
L P111.16	AI2 status	-	- (Read only)	0x2DA5:016	general
P112.xx	AO1 diagnostics				
L P112.01	AO1 Voltage	x.xx V	- (Read only)	0x2DAA:001	general
L P112.02	AO1 Current	x.xx mA	- (Read only)	0x2DAA:002	general
P113.xx	AO2 diagnostics				
L P113.01	AO2 Current	x.xx V	- (Read only)	0x2DAB:001	Appl. I/O
L P113.02	AO2 Voltage	x.xx mA	- (Read only)	0x2DAB:002	Appl. I/O
P115.xx	HTL inp. diag.				
L P115.01	Input frequency	x.x Hz	- (Read only)	0x2642:001	general
L P115.02	Freq. setpoint	x.x Hz	- (Read only)	0x2642:002	general
L P115.03	PID setpoint	x.xx PID unit	- (Read only)	0x2642:003	general
L P115.04	Torque setpoint	x.x %	- (Read only)	0x2642:004	general
P117.xx	Heatsink temp.				
L P117.01	Heatsink temp.	x.x °C	- (Read only)	0x2D84:001	general
P118.00	Digital inputs	-	- (Read only)	0x60FD	general
P119.00	Keypad status	-	- (Read only)	0x2DAC	general

* Default setting depending on the size.

Firmware version 04.00.00.00

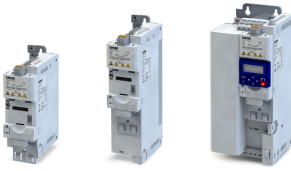

Commissioning

Keypad parameter list

Display code	Short designation	Default setting	Setting range	Address	Category
P120.00	Int. HW states	-	-(Read only)	0x2DAD	general
P121.xx					
└ P121.01	PID setpoint	x.xx PID unit	-(Read only)	0x401F:001	general
└ P121.02	PID process var.	x.xx PID unit	-(Read only)	0x401F:002	general
└ P121.03	PID status	-	-(Read only)	0x401F:003	general
P123.00	Mot. i2t utilis.	x %	-(Read only)	0x2D4F	general
P125.xx	Inverter diag.				
└ P125.01	Active control	-	-(Read only)	0x282B:001	general
└ P125.02	Active setpoint	-	-(Read only)	0x282B:002	general
└ P125.03	Keypad LCD stat.	-	-(Read only)	0x282B:003	general
└ P125.04	Drive mode	-	-(Read only)	0x282B:004	general
└ P125.05	Netw. contr.reg.	-	-(Read only)	0x282B:005	general
└ P125.06	Netw. setp.reg.	-	-(Read only)	0x282B:006	general
P126.xx	Status words				
└ P126.01	Cause of disable	-	-(Read only)	0x282A:001	general
└ P126.02	Cause of QSP	-	-(Read only)	0x282A:002	general
└ P126.03	Cause of stop	-	-(Read only)	0x282A:003	general
└ P126.05	Device status	-	-(Read only)	0x282A:005	general
P135.xx	Device utilisat.				
└ P135.04	ixt utilisation	x %	-(Read only)	0x2D40:004	general
└ P135.05	Error response	Fault [3]	Selection list	0x2D40:005	general
P140.xx	Sequencer diag				
└ P140.01	Active Step	-	-(Read only)	0x2DAE:001	general
└ P140.02	StepTime elapsed	x.x s	-(Read only)	0x2DAE:002	general
└ P140.03	StepTime remain	x.x s	-(Read only)	0x2DAE:003	general
└ P140.04	Steps complete	-	-(Read only)	0x2DAE:004	general
└ P140.05	Steps remain	-	-(Read only)	0x2DAE:005	general
└ P140.06	Active sequence	-	-(Read only)	0x2DAE:006	general
└ P140.07	Active segment	-	-(Read only)	0x2DAE:007	general
└ P140.08	SeqTime remain %	x %	-(Read only)	0x2DAE:008	general
└ P140.09	SeqTime remain	x.x s	-(Read only)	0x2DAE:009	general
P150.00	Error code	-	-(Read only)	0x603F	general
P151.xx	Life-diagnosis				
└ P151.01	Operating time	x s	-(Read only)	0x2D81:001	general
└ P151.02	Power-on time	x s	-(Read only)	0x2D81:002	general
└ P151.03	CU oper. time	x ns	-(Read only)	0x2D81:003	general
└ P151.04	Switching cycles	-	-(Read only)	0x2D81:004	general
└ P151.05	Relay cycles	-	-(Read only)	0x2D81:005	general
└ P151.06	Short-circ.count	-	-(Read only)	0x2D81:006	general
└ P151.07	Earthfault count	-	-(Read only)	0x2D81:007	general
└ P151.08	Clamp active	-	-(Read only)	0x2D81:008	general
└ P151.09	Fan oper. time	x s	-(Read only)	0x2D81:009	general
P155.xx	Fault memory				
└ P155.00	Error memory	-	-(Read only)	0x2006:000	general
P190.xx	Device data				
└ P190.01	Product code	-	-(Read only)	0x2000:001	general
└ P190.02	Serial number	-	-(Read only)	0x2000:002	general
└ P190.04	CU firmware ver.	-	-(Read only)	0x2000:004	general
└ P190.05	CU firmware type	-	-(Read only)	0x2000:005	general
└ P190.06	CU bootldr ver.	-	-(Read only)	0x2000:006	general
└ P190.07	CU bootldr type	-	-(Read only)	0x2000:007	general
└ P190.08	OBD version	-	-(Read only)	0x2000:008	general
└ P190.10	PU firmware ver.	-	-(Read only)	0x2000:010	general
└ P190.11	PU firmware type	-	-(Read only)	0x2000:011	general

* Default setting depending on the size.

Firmware version 04.00.00.00

Commissioning

Keypad parameter list



Display code	Short designation	Default setting	Setting range	Address	Category
↳ P190.12	PU bootldr ver.	-	- (Read only)	0x2000:012	general
↳ P190.13	PU bootldr type	-	- (Read only)	0x2000:013	general
↳ P190.14	Mod. firmware	-	- (Read only)	0x2000:014	general
P191.00	Device name	My Device	Text	0x2001	general
P192.xx	Device module				
↳ P192.04	CU type code	-	- (Read only)	0x2002:004	general
↳ P192.05	PU type code	-	- (Read only)	0x2002:005	general
↳ P192.06	CU serial number	-	- (Read only)	0x2002:006	general
↳ P192.07	PU serial number	-	- (Read only)	0x2002:007	general
P197.00	Protect. status	-	- (Read only)	0x2040	general
P198.00	Status load. par	-	- (Read only)	0x2827	general
P200.00	Control select.	Flexible I/O [0]	Selection list	0x2824	general
P201.xx	Stnd. setpoints				
↳ P201.01	Freq. setp. src.	Analog input 1 [2]	Selection list	0x2860:001	general
↳ P201.02	PID setp. src.	Keypad [1]	Selection list	0x2860:002	general
↳ P201.03	Torque setp.src.	Analog input 1 [2]	Selection list	0x2860:003	general
P202.xx	Keypad setpoints				
↳ P202.01	KP freq.setpoint	20.0 Hz	0.0 ... 599.0 Hz	0x2601:001	general
↳ P202.02	KP PID setpoint	0.00 PID unit	-300.00 ... 300.00 PID unit	0x2601:002	general
↳ P202.03	KP torq.setpoint	100.0 %	-400.0 ... 400.0 %	0x2601:003	general
P203.xx	Start/stop cfg				
↳ P203.01	Start method	Normal [0]	Selection list	0x2838:001	general
↳ P203.02	Start at powerup	Off [0]	Selection list	0x2838:002	general
↳ P203.03	Stop method	Standard ramp [1]	Selection list	0x2838:003	general
P208.xx	Mains settings				
↳ P208.01	Mains voltage	230 Veff [0]	Selection list	0x2540:001	general
↳ P208.02	LU warn. thresh.	0 V *	0 ... 800 V	0x2540:002	general
↳ P208.03	LU error thresh.	x V	- (Read only)	0x2540:003	general
↳ P208.04	LU reset thresh.	x V	- (Read only)	0x2540:004	general
↳ P208.05	OU warn. thresh.	0 V *	0 ... 800 V	0x2540:005	general
↳ P208.06	OU error thresh.	x V	- (Read only)	0x2540:006	general
↳ P208.07	OU reset thresh.	x V	- (Read only)	0x2540:007	general
P210.00	Min. frequency	0.0 Hz	0.0 ... 599.0 Hz	0x2915	general
P211.00	Max. frequency	Device for 50-Hz mains: 50.0 Hz Device for 60-Hz mains: 60.0 Hz	0.0 ... 599.0 Hz	0x2916	general
P220.00	Accelerat.time 1	5.0 s	0.0 ... 3600.0 s	0x2917	general
P221.00	Decelerat.time 1	5.0 s	0.0 ... 3600.0 s	0x2918	general
P222.00	Accelerat.time 2	5.0 s	0.0 ... 3600.0 s	0x2919	general
P223.00	Decelerat.time 2	5.0 s	0.0 ... 3600.0 s	0x291A	general
P224.00	Ramp 2 thresh.	0.0 Hz	0.0 ... 599.0 Hz	0x291B	general
P225.00	QSP dec. time	1.0 s	0.0 ... 3600.0 s	0x291C	general
P226.xx	S-ramp char.				
↳ P226.01	Smoothing factor	0.0 %	0.0 ... 100.0 %	0x291E:001	general
P230.xx	Optical tracking				
↳ P230.01	Start detection	Stop [0]	Selection list	0x2021:001	general
↳ P230.02	Blink. duration	5 s	0 ... 3600 s	0x2021:002	general
P300.00	Motor ctrl mode	VFC open loop [6]	Selection list	0x2C00	general
P301.00	Modes of op.	MS: Velocitymode [-2]	Selection list	0x6060	general
P302.00	V/f charac.shape	Linear [0]	Selection list	0x2B00	general
P303.xx	V/f shape data				
↳ P303.01	Base voltage	230 V *	0 ... 5000 V	0x2B01:001	MCTRL

* Default setting depending on the size.

Firmware version 04.00.00.00



Commissioning

Keypad parameter list

Display code	Short designation	Default setting	Setting range	Address	Category
↳ P303.02	Base frequency	Device for 50-Hz mains: 50 Hz Device for 60-Hz mains: 60 Hz *	0 ... 1500 Hz	0x2B01:002	MCTRL
↳ P303.03	Midpoint voltage	0 V	0 ... 5000 V	0x2B01:003	MCTRL
↳ P303.04	Midpoint freq	0 Hz	0 ... 1500 Hz	0x2B01:004	MCTRL
P304.00	Limit. rotation	Both directions [1]	Selection list	0x283A	general
P305.00	Switching freq.	0 *	Selection list	0x2939	general
P308.xx	Motor overload				
↳ P308.01	Max.load.for 60s	150 %	30 ... 200 %	0x2D4B:001	general
↳ P308.02	Speed comp.	On [0]	Selection list	0x2D4B:002	general
↳ P308.03	Response	Fault [3]	Selection list	0x2D4B:003	general
P309.xx	Mot.temp.monit.				
↳ P309.02	Response	Fault [3]	Selection list	0x2D49:002	general
P310.xx	Mot.phase.fail.				
↳ P310.01	Response	No response [0]	Selection list	0x2D45:001	general
↳ P310.02	Current thresh.	5.0 %	1.0 ... 25.0 %	0x2D45:002	general
↳ P310.03	Voltage thresh.	10.0 V	0.0 ... 100.0 V	0x2D45:003	general
P315.xx	Slip compens.				
↳ P315.01	Slip: gain	100.00 %	-200.00 ... 200.00 %	0x2B09:001	general
↳ P315.02	Filter time	5 ms	1 ... 6000 ms	0x2B09:002	general
P316.xx	V/f boosts				
↳ P316.01	Fixed V/f boost	2.5 % *	0.0 ... 20.0 %	0x2B12:001	MCTRL
↳ P316.02	Dynam. V/f boost	0.0 %	0.0 ... 20.0 %	0x2B12:002	general
P317.xx	Skip frequencies				
↳ P317.01	Skip frequency 1	0.0 Hz	0.0 ... 599.0 Hz	0x291F:001	general
↳ P317.02	Skip bandwidth 1	0.0 Hz	0.0 ... 10.0 Hz	0x291F:002	general
↳ P317.03	Skip frequency 2	0.0 Hz	0.0 ... 599.0 Hz	0x291F:003	general
↳ P317.04	Skip bandwidth 2	0.0 Hz	0.0 ... 10.0 Hz	0x291F:004	general
↳ P317.05	Skip frequency 3	0.0 Hz	0.0 ... 599.0 Hz	0x291F:005	general
↳ P317.06	Skip bandwidth 3	0.0 Hz	0.0 ... 10.0 Hz	0x291F:006	general
P318.xx	Oscillat. damp.				
↳ P318.01	Gain	20 %	-100 ... 100 %	0x2B0A:001	MCTRL
↳ P318.02	Filter time	5 ms	1 ... 600 ms	0x2B0A:002	MCTRL
P319.00	Field weak thold	0.0 Hz	-599.0 ... 599.0 Hz	0x2B0C	general
P320.xx	Motor parameters				
↳ P320.04	Rated speed	Device for 50-Hz mains: 1450 rpm Device for 60-Hz mains: 1750 rpm	50 ... 50000 rpm	0x2C01:004	MCTRL
↳ P320.05	Rated frequency	Device for 50-Hz mains: 50.0 Hz Device for 60-Hz mains: 60.0 Hz	1.0 ... 1000.0 Hz	0x2C01:005	MCTRL
↳ P320.06	Rated power	0.25 kW *	0.00 ... 655.35 kW	0x2C01:006	MCTRL
↳ P320.07	Rated voltage	230 V *	0 ... 65535 V	0x2C01:007	MCTRL
↳ P320.08	Cosine phi	0.80	0.00 ... 1.00	0x2C01:008	MCTRL
P322.00	Max motor speed	6075 rpm	0 ... 480000 rpm	0x6080	general
P323.00	Motor current	1.700 A *	0.001 ... 500.000 A	0x6075	MCTRL
P324.00	Max current	200.0 %	0.0 ... 3000.0 %	0x6073	general
P325.00	Motor torque	1.650 Nm *	0.001 ... 1000.000 Nm	0x6076	MCTRL
P326.00	Max torque	250.0 %	0.0 ... 3000.0 %	0x6072	general
↳ P327.04	Identify mot.	0	0 ... 1	0x2822:004	general
↳ P327.05	Calibrate mot.	0	0 ... 1	0x2822:005	general
P329.xx	MaxTrq.Monitor				

* Default setting depending on the size.

Firmware version 04.00.00.00

Commissioning

Keypad parameter list



Display code	Short designation	Default setting	Setting range	Address	Category
↳ P329.01	Response	No response [0]	Selection list	0x2D67:001	MCTRL
↳ P329.02	Triggering delay	0.000 s	0.000 ... 10.000 s	0x2D67:002	MCTRL
P330.xx	VFC-ECO				
↳ P330.01	Min. voltage	20 %	20 ... 100 %	0x2B0D:001	MCTRL
P332.xx	Speed controller				
↳ P332.01	Gain	0.00193 Nm/rpm *	0.00000 ... 20000.00000 Nm/rpm	0x2900:001	MCTRL
↳ P332.02	Reset time	80.0 ms *	1.0 ... 6000.0 ms	0x2900:002	MCTRL
P333.xx	V/f I _{max} contr.				
↳ P333.01	Gain	0.284 Hz/A *	0.000 ... 1000.000 Hz/A	0x2B08:001	MCTRL
↳ P333.02	Reset time	2.3 ms *	1.0 ... 2000.0 ms	0x2B08:002	MCTRL
P334.xx	Current contr.				
↳ P334.01	Gain	42.55 V/A *	0.00 ... 750.00 V/A	0x2942:001	MCTRL
↳ P334.02	Reset time	4.50 ms *	0.01 ... 2000.00 ms	0x2942:002	MCTRL
P335.xx	Moment of inert.				
↳ P335.01	Motor inertia	3.70 kg cm ² *	0.00 ... 20000000.00 kg cm ²	0x2910:001	MCTRL
↳ P335.02	Load inertia	3.70 kg cm ² *	0.00 ... 20000000.00 kg cm ²	0x2910:002	MCTRL
↳ P336.02	Ramp time	1.0 s	0.0 ... 60.0 s	0x2948:002	general
P337.xx					
↳ P337.01	Pos. torqlim src	Max torque [0]	Selection list	0x2949:001	general
↳ P337.02	Neg. torqlim src	(-) Max torque [0]	Selection list	0x2949:002	general
↳ P337.03	Act postorqlim	x.x %	- (Read only)	0x2949:003	general
↳ P337.04	Act negtorqlim	x.x %	- (Read only)	0x2949:004	general
P340.xx	Speed limitation				
↳ P340.01	Upper limit	0 vel. unit	-480000 ... 480000 vel. unit	0x2946:001	general
↳ P340.02	Lower limit	0 vel. unit	-480000 ... 480000 vel. unit	0x2946:002	general
↳ P340.03	Uppspeerd lim src	Max. frequency [0]	Selection list	0x2946:003	general
↳ P340.04	Lowspeerd lim src	(-) Max. freq. [0]	Selection list	0x2946:004	general
↳ P340.05	Upper freq.limit	Device for 50-Hz mains: 50.0 Hz Device for 60-Hz mains: 60.0 Hz	-1000.0 ... 1000.0 Hz	0x2946:005	general
↳ P340.06	Lower freq.limit	Device for 50-Hz mains: -50.0 Hz Device for 60-Hz mains: -60.0 Hz	-1000.0 ... 1000.0 Hz	0x2946:006	general
↳ P340.07	Act uppspeerd lim	x.x Hz	- (Read only)	0x2946:007	general
↳ P340.08	Act lowspeerd lim	x.x Hz	- (Read only)	0x2946:008	general
P341.xx	Encoder settings				
↳ P341.01	Enc. Inc/Rev	128	1 ... 16384	0x2C42:001	general
P342.00	Enc.error resp.	Warning [1]	Selection list	0x2C45	general
P350.xx	Overspeed monit.				
↳ P350.01	Threshold	8000 rpm	50 ... 50000 rpm	0x2D44:001	general
↳ P350.02	Response	Fault [3]	Selection list	0x2D44:002	general
P351.xx	ASM motor par.				
↳ P351.01	Rotor resistance	8.8944 Ω *	0.0000 ... 200.0000 Ω	0x2C02:001	MCTRL
↳ P351.02	Mutual induct.	381.9 mH *	0.0 ... 50000.0 mH	0x2C02:002	MCTRL
↳ P351.03	Magn. current	0.96 A *	0.00 ... 500.00 A	0x2C02:003	MCTRL
↳ P351.04	Slip frequency	x.x Hz	- (Read only)	0x2C02:004	general
P352.xx	PSM motor par.				
↳ P352.01	BEMF constant	41.8 V/1000rpm	0.0 ... 100000.0 V/1000rpm	0x2C03:001	MCTRL
P353.xx	Overcurr. monit.				
↳ P353.01	Threshold	6.8 A *	0.0 ... 1000.0 A	0x2D46:001	general
↳ P353.02	Response	Fault [3]	Selection list	0x2D46:002	general
P354.00	Voltage reserve	5 %	1 ... 20 %	0x29E4	general

* Default setting depending on the size.

Firmware version 04.00.00.00

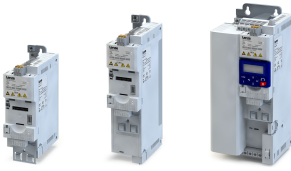

Commissioning

Keypad parameter list

Display code	Short designation	Default setting	Setting range	Address	Category
P400.xx	Function list				
L P400.01	Enable inverter	TRUE [1]	Selection list	0x2631:001	general
L P400.02	Run	Digital input 1 [11]	Selection list	0x2631:002	general
L P400.03	Quick stop	Not connected [0]	Selection list	0x2631:003	general
L P400.04	Reset fault	Digital input 2 [12]	Selection list	0x2631:004	general
L P400.05	DC braking	Not connected [0]	Selection list	0x2631:005	general
L P400.06	Start forward	Not connected [0]	Selection list	0x2631:006	general
L P400.07	Start reverse	Not connected [0]	Selection list	0x2631:007	general
L P400.08	Run forward	Not connected [0]	Selection list	0x2631:008	general
L P400.09	Run reverse	Not connected [0]	Selection list	0x2631:009	general
L P400.10	Jog forward	Not connected [0]	Selection list	0x2631:010	general
L P400.11	Jog reverse	Not connected [0]	Selection list	0x2631:011	general
L P400.12	Keypad control	Not connected [0]	Selection list	0x2631:012	general
L P400.13	Invert rotation	Digital input 3 [13]	Selection list	0x2631:013	general
L P400.14	Setp: AI1	Not connected [0]	Selection list	0x2631:014	general
L P400.15	Setp: AI2	Not connected [0]	Selection list	0x2631:015	general
L P400.16	Setp: Keypad	Not connected [0]	Selection list	0x2631:016	general
L P400.17	Setp: Network	Not connected [0]	Selection list	0x2631:017	general
L P400.18	Setp: Preset b0	Digital input 4 [14]	Selection list	0x2631:018	general
L P400.19	Setp: Preset b1	Digital input 5 [15]	Selection list	0x2631:019	general
L P400.20	Setp: Preset b2	Not connected [0]	Selection list	0x2631:020	general
L P400.21	Setp: Preset b3	Not connected [0]	Selection list	0x2631:021	general
L P400.22	Setp: HTL input	Not connected [0]	Selection list	0x2631:022	general
L P400.23	MOP up	Not connected [0]	Selection list	0x2631:023	general
L P400.24	MOP down	Not connected [0]	Selection list	0x2631:024	general
L P400.25	Setp: MOP	Not connected [0]	Selection list	0x2631:025	general
L P400.26	Setp: Segment b0	Not connected [0]	Selection list	0x2631:026	general
L P400.27	Setp: Segment b1	Not connected [0]	Selection list	0x2631:027	general
L P400.28	Setp: Segment b2	Not connected [0]	Selection list	0x2631:028	general
L P400.29	Setp: Segment b3	Not connected [0]	Selection list	0x2631:029	general
L P400.30	Seq: Run/abort	Not connected [0]	Selection list	0x2631:030	general
L P400.31	Seq: Start	Not connected [0]	Selection list	0x2631:031	general
L P400.32	Seq: Next step	Not connected [0]	Selection list	0x2631:032	general
L P400.33	Seq: Pause	Not connected [0]	Selection list	0x2631:033	general
L P400.34	Seq: Suspense	Not connected [0]	Selection list	0x2631:034	general
L P400.35	Seq: Stop	Not connected [0]	Selection list	0x2631:035	general
L P400.36	Seq: Abort	Not connected [0]	Selection list	0x2631:036	general
L P400.37	Network control	Not connected [0]	Selection list	0x2631:037	general
L P400.39	Activ. ramp 2	Not connected [0]	Selection list	0x2631:039	general
L P400.40	Load param.set	Not connected [0]	Selection list	0x2631:040	general
L P400.41	Sel. paramset b0	Not connected [0]	Selection list	0x2631:041	general
L P400.42	Sel. paramset b1	Not connected [0]	Selection list	0x2631:042	general
L P400.43	Fault 1	Not connected [0]	Selection list	0x2631:043	general
L P400.44	Fault 2	Not connected [0]	Selection list	0x2631:044	general
L P400.45	PID off	Not connected [0]	Selection list	0x2631:045	general
L P400.46	PID output=0	Not connected [0]	Selection list	0x2631:046	general
L P400.47	PID-I inhibited	Not connected [0]	Selection list	0x2631:047	general
L P400.48	PID-Inf ramp on	TRUE [1]	Selection list	0x2631:048	general
L P400.49	Release brake	Not connected [0]	Selection list	0x2631:049	general
L P400.50	Seq: Select. b0	Not connected [0]	Selection list	0x2631:050	general
L P400.51	Seq: Select. b1	Not connected [0]	Selection list	0x2631:051	general
L P400.52	Seq: Select. b2	Not connected [0]	Selection list	0x2631:052	general
L P400.53	Seq: Select. b3	Not connected [0]	Selection list	0x2631:053	general
L P400.54	PosCounter reset	Not connected [0]	Selection list	0x2631:054	general

* Default setting depending on the size.

Firmware version 04.00.00.00

Commissioning

Keypad parameter list



Display code	Short designation	Default setting	Setting range	Address	Category
P410.xx	DI settings				
↳ P410.01	Assertion level	HIGH active [1]	Selection list	0x2630:001	general
↳ P410.02	Input function	Digital Input [0]	Selection list	0x2630:002	general
P411.xx	DI inversion				
↳ P411.01	DI1 inversion	Not inverted [0]	Selection list	0x2632:001	general
↳ P411.02	DI2 inversion	Not inverted [0]	Selection list	0x2632:002	general
↳ P411.03	DI3 inversion	Not inverted [0]	Selection list	0x2632:003	general
↳ P411.04	DI4 inversion	Not inverted [0]	Selection list	0x2632:004	general
↳ P411.05	DI5 inversion	Not inverted [0]	Selection list	0x2632:005	general
↳ P411.06	DI6 inversion	Not inverted [0]	Selection list	0x2632:006	Appl. I/O
↳ P411.07	DI7 inversion	Not inverted [0]	Selection list	0x2632:007	Appl. I/O
P412.00	Freq. threshold	0.0 Hz	0.0 ... 599.0 Hz	0x4005	general
P413.00	MOP startmode	Last value [0]	Selection list	0x4003	general
P414.xx	MOP start value				
↳ P414.01	Frequency	0.0 Hz	0.0 ... 599.0 Hz	0x4004:001	general
↳ P414.02	PID value	0.00 PID unit	-300.00 ... 300.00 PID unit	0x4004:002	general
↳ P414.03	Torque	0.0 %	0.0 ... 1000.0 %	0x4004:003	general
P415.xx	HTL inp. setting				
↳ P415.01	Min.frequency	0.0 Hz	-100000.0 ... 100000.0 Hz	0x2640:001	general
↳ P415.02	Max. frequency	0.0 Hz	-100000.0 ... 100000.0 Hz	0x2640:002	general
↳ P415.03	Min.motor.freq	0.0 Hz	-1000.0 ... 1000.0 Hz	0x2640:003	general
↳ P415.04	Max.motor.freq	Device for 50-Hz mains: 50.0 Hz Device for 60-Hz mains: 60.0 Hz	-1000.0 ... 1000.0 Hz	0x2640:004	general
↳ P415.05	Min.PID setpoint	0.00 PID unit	-300.00 ... 300.00 PID unit	0x2640:005	general
↳ P415.06	Max.PID setpoint	100.00 PID unit	-300.00 ... 300.00 PID unit	0x2640:006	general
↳ P415.07	Min.torque setp.	0.0 %	-400.0 ... 400.0 %	0x2640:007	general
↳ P415.08	Max.torque setp	100.0 %	-400.0 ... 400.0 %	0x2640:008	general
↳ P415.09	Filter time	10 ms	0 ... 10000 ms	0x2640:009	general
P416.xx	HTL inp. monit.				
↳ P416.01	Min.freq.thresh.	0.0 Hz	-214748364.8 ... 214748364.7 Hz	0x2641:001	general
↳ P416.02	Min.delay thres.	5.0 s	0.0 ... 300.0 s	0x2641:002	general
↳ P416.03	Max.freq.thresh.	0.0 Hz	-214748364.8 ... 214748364.7 Hz	0x2641:003	general
↳ P416.04	Max.delay thres.	5.0 s	0.0 ... 300.0 s	0x2641:004	general
↳ P416.05	Monit. condition	< min. frequency [1]	Selection list	0x2641:005	general
↳ P416.06	Error response	Warning [1]	Selection list	0x2641:006	general
P420.xx	Dig.out.function				
↳ P420.01	Relay function	Rdy for operat. [51]	Selection list	0x2634:001	general
↳ P420.02	DO1 function	Release brake [115]	Selection list	0x2634:002	general
↳ P420.03	DO2 function	Error [56]	Selection list	0x2634:003	Appl. I/O
↳ P420.10	NetWordOUT1.00	Rdy for operat. [51]	Selection list	0x2634:010	general
↳ P420.11	NetWordOUT1.01	Not connected [0]	Selection list	0x2634:011	general
↳ P420.12	NetWordOUT1.02	Operat. enabled [52]	Selection list	0x2634:012	general
↳ P420.13	NetWordOUT1.03	Error [56]	Selection list	0x2634:013	general
↳ P420.14	NetWordOUT1.04	Not connected [0]	Selection list	0x2634:014	general
↳ P420.15	NetWordOUT1.05	Quick stop [54]	Selection list	0x2634:015	general
↳ P420.16	NetWordOUT1.06	Running [50]	Selection list	0x2634:016	general
↳ P420.17	NetWordOUT1.07	Device warning [58]	Selection list	0x2634:017	general
↳ P420.18	NetWordOUT1.08	Not connected [0]	Selection list	0x2634:018	general
↳ P420.19	NetWordOUT1.09	Not connected [0]	Selection list	0x2634:019	general
↳ P420.20	NetWordOUT1.10	Speed - setp=act [72]	Selection list	0x2634:020	general
↳ P420.21	NetWordOUT1.11	At current limit [78]	Selection list	0x2634:021	general

* Default setting depending on the size.

Firmware version 04.00.00.00



Commissioning

Keypad parameter list

Display code	Short designation	Default setting	Setting range	Address	Category
L P420.22	NetWordOUT1.12	Actual speed=0 [71]	Selection list	0x2634:022	general
L P420.23	NetWordOUT1.13	Rot.dir.reversed [69]	Selection list	0x2634:023	general
L P420.24	NetWordOUT1.14	Release brake [115]	Selection list	0x2634:024	general
L P420.25	NetWordOUT1.15	Safe Torque Off [55]	Selection list	0x2634:025	general
P421.xx	DO inversion				
L P421.01	Relay inverted	Not inverted [0]	Selection list	0x2635:001	general
L P421.02	DO1 inversion	Not inverted [0]	Selection list	0x2635:002	general
L P421.03	DO2 inversion	Not inverted [0]	Selection list	0x2635:003	Appl. I/O
P430.xx	Analog input 1				
L P430.01	AI1 input range	0 ... 10 VDC [0]	Selection list	0x2636:001	general
L P430.02	AI1 freq @ min	0.0 Hz	-1000.0 ... 1000.0 Hz	0x2636:002	general
L P430.03	AI1 freq @ max	Device for 50-Hz mains: 50.0 Hz Device for 60-Hz mains: 60.0 Hz	-1000.0 ... 1000.0 Hz	0x2636:003	general
L P430.04	AI1 PID @ min	0.00 PID unit	-300.00 ... 300.00 PID unit	0x2636:004	general
L P430.05	AI1 PID @ max	100.00 PID unit	-300.00 ... 300.00 PID unit	0x2636:005	general
L P430.06	AI1 filter time	10 ms	0 ... 10000 ms	0x2636:006	general
L P430.07	AI1 dead band	0.0 %	0.0 ... 100.0 %	0x2636:007	general
L P430.08	AI1 monit.level	0.0 %	-100.0 ... 100.0 %	0x2636:008	general
L P430.09	AI1 monit.cond.	IN < threshold [0]	Selection list	0x2636:009	general
L P430.10	AI1 error resp.	Fault [3]	Selection list	0x2636:010	general
L P430.11	Min. torque	0.0 %	-400.0 ... 400.0 %	0x2636:011	general
L P430.12	Max. torque	100.0 %	-400.0 ... 400.0 %	0x2636:012	general
P431.xx	Analog input 2				
L P431.01	AI2 input range	0 ... 10 VDC [0]	Selection list	0x2637:001	general
L P431.02	AI2 freq @ min	0.0 Hz	-1000.0 ... 1000.0 Hz	0x2637:002	general
L P431.03	AI2 freq @ max	Device for 50-Hz mains: 50.0 Hz Device for 60-Hz mains: 60.0 Hz	-1000.0 ... 1000.0 Hz	0x2637:003	general
L P431.04	AI2 PID @ min	0.00 PID unit	-300.00 ... 300.00 PID unit	0x2637:004	general
L P431.05	AI2 PID @ max	100.00 PID unit	-300.00 ... 300.00 PID unit	0x2637:005	general
L P431.06	AI2 filter time	10 ms	0 ... 10000 ms	0x2637:006	general
L P431.07	AI2 dead band	0.0 %	0.0 ... 100.0 %	0x2637:007	general
L P431.08	AI2 monit.level	0.0 %	-100.0 ... 100.0 %	0x2637:008	general
L P431.09	AI2 error resp.	IN < threshold [0]	Selection list	0x2637:009	general
L P431.10	AI2 error resp.	Fault [3]	Selection list	0x2637:010	general
L P431.11	Min. torque	0.0 %	-400.0 ... 400.0 %	0x2637:011	general
L P431.12	Max. torque	100.0 %	-400.0 ... 400.0 %	0x2637:012	general
P440.xx	Analog output 1				
L P440.01	AO1 outp. range	0 ... 10 VDC [1]	Selection list	0x2639:001	general
L P440.02	AO1 function	Outp. frequency [1]	Selection list	0x2639:002	general
L P440.03	AO1 min. signal	0	-2147483648 ... 2147483647	0x2639:003	general
L P440.04	AO1 max. signal	1000	-2147483648 ... 2147483647	0x2639:004	general
P441.xx	Analog output 2				
L P441.01	AO2 outp. range	0 ... 10 VDC [1]	Selection list	0x263A:001	Appl. I/O
L P441.02	AO2 function	Motor current [5]	Selection list	0x263A:002	Appl. I/O
L P441.03	AO2 min. signal	0	-2147483648 ... 2147483647	0x263A:003	Appl. I/O
L P441.04	AO2 max. signal	1000	-2147483648 ... 2147483647	0x263A:004	Appl. I/O
P450.xx	Freq. presets				
L P450.01	Freq. preset 1	20.0 Hz	0.0 ... 599.0 Hz	0x2911:001	general
L P450.02	Freq. preset 2	40.0 Hz	0.0 ... 599.0 Hz	0x2911:002	general

* Default setting depending on the size.

Firmware version 04.00.00.00

Commissioning

Keypad parameter list



Display code	Short designation	Default setting	Setting range	Address	Category
↳ P450.03	Freq. preset 3	Device for 50-Hz mains: 50.0 Hz Device for 60-Hz mains: 60.0 Hz	0.0 ... 599.0 Hz	0x2911:003	general
↳ P450.04	Freq. preset 4	0.0 Hz	0.0 ... 599.0 Hz	0x2911:004	general
↳ P450.05	Freq. preset 5	0.0 Hz	0.0 ... 599.0 Hz	0x2911:005	general
↳ P450.06	Freq. preset 6	0.0 Hz	0.0 ... 599.0 Hz	0x2911:006	general
↳ P450.07	Freq. preset 7	0.0 Hz	0.0 ... 599.0 Hz	0x2911:007	general
↳ P450.08	Freq. preset 8	0.0 Hz	0.0 ... 599.0 Hz	0x2911:008	general
↳ P450.09	Freq. preset 9	0.0 Hz	0.0 ... 599.0 Hz	0x2911:009	general
↳ P450.10	Freq. preset 10	0.0 Hz	0.0 ... 599.0 Hz	0x2911:010	general
↳ P450.11	Freq. preset 11	0.0 Hz	0.0 ... 599.0 Hz	0x2911:011	general
↳ P450.12	Freq. preset 12	0.0 Hz	0.0 ... 599.0 Hz	0x2911:012	general
↳ P450.13	Freq. preset 13	0.0 Hz	0.0 ... 599.0 Hz	0x2911:013	general
↳ P450.14	Freq. preset 14	0.0 Hz	0.0 ... 599.0 Hz	0x2911:014	general
↳ P450.15	Freq. preset 15	0.0 Hz	0.0 ... 599.0 Hz	0x2911:015	general
P451.xx	PID presets				
↳ P451.01	PID preset 1	0.00 PID unit	-300.00 ... 300.00 PID unit	0x4022:001	general
↳ P451.02	PID preset 2	0.00 PID unit	-300.00 ... 300.00 PID unit	0x4022:002	general
↳ P451.03	PID preset 3	0.00 PID unit	-300.00 ... 300.00 PID unit	0x4022:003	general
↳ P451.04	PID preset 4	0.00 PID unit	-300.00 ... 300.00 PID unit	0x4022:004	general
↳ P451.05	PID preset 5	0.00 PID unit	-300.00 ... 300.00 PID unit	0x4022:005	general
↳ P451.06	PID preset 6	0.00 PID unit	-300.00 ... 300.00 PID unit	0x4022:006	general
↳ P451.07	PID preset 7	0.00 PID unit	-300.00 ... 300.00 PID unit	0x4022:007	general
↳ P451.08	PID preset 8	0.00 PID unit	-300.00 ... 300.00 PID unit	0x4022:008	general
P452.xx	Torque presets				
↳ P452.01	Torque preset 1	100.0 %	-400.0 ... 400.0 %	0x2912:001	general
↳ P452.02	Torque preset 2	100.0 %	-400.0 ... 400.0 %	0x2912:002	general
↳ P452.03	Torque preset 3	100.0 %	-400.0 ... 400.0 %	0x2912:003	general
↳ P452.04	Torque preset 4	100.0 %	-400.0 ... 400.0 %	0x2912:004	general
↳ P452.05	Torque preset 5	100.0 %	-400.0 ... 400.0 %	0x2912:005	general
↳ P452.06	Torque preset 6	100.0 %	-400.0 ... 400.0 %	0x2912:006	general
↳ P452.07	Torque preset 7	100.0 %	-400.0 ... 400.0 %	0x2912:007	general
↳ P452.08	Torque preset 8	100.0 %	-400.0 ... 400.0 %	0x2912:008	general
P500.xx	Module ID				
↳ P500.01	Active module ID	-	-(Read only)	0x231F:001	general
↳ P500.02	Module ID conn.	-	-(Read only)	0x231F:002	general
P505.xx	NetWordIN1 fct.				
↳ P505.01	NetWordIN1.00	Not active [0]	Selection list	0x400E:001	general
↳ P505.02	NetWordIN1.01	Not active [0]	Selection list	0x400E:002	general
↳ P505.03	NetWordIN1.02	Quick stop [3]	Selection list	0x400E:003	general
↳ P505.04	NetWordIN1.03	Not active [0]	Selection list	0x400E:004	general
↳ P505.05	NetWordIN1.04	Run forward [8]	Selection list	0x400E:005	general
↳ P505.06	NetWordIN1.05	Setp: Preset b0 [18]	Selection list	0x400E:006	general
↳ P505.07	NetWordIN1.06	Setp: Preset b1 [19]	Selection list	0x400E:007	general
↳ P505.08	NetWordIN1.07	Reset error [4]	Selection list	0x400E:008	general
↳ P505.09	NetWordIN1.08	Not active [0]	Selection list	0x400E:009	general
↳ P505.10	NetWordIN1.09	DC braking [5]	Selection list	0x400E:010	general
↳ P505.11	NetWordIN1.10	Not active [0]	Selection list	0x400E:011	general
↳ P505.12	NetWordIN1.11	Not active [0]	Selection list	0x400E:012	general
↳ P505.13	NetWordIN1.12	Invert rotation [13]	Selection list	0x400E:013	general
↳ P505.14	NetWordIN1.13	Not active [0]	Selection list	0x400E:014	general
↳ P505.15	NetWordIN1.14	Not active [0]	Selection list	0x400E:015	general
↳ P505.16	NetWordIN1.15	Not active [0]	Selection list	0x400E:016	general
* Default setting depending on the size.				Firmware version 04.00.00.00	

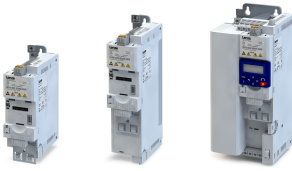

Commissioning

Keypad parameter list

Display code	Short designation	Default setting	Setting range	Address	Category
P508.00	CANopen comm.	No action [0]	Selection list	0x2300	CANopen
P508.00	EtherCAT comm.	No action [0]	Selection list	0x2360	EtherCAT
P508.00	EtherN/IP comm.	No action [0]	Selection list	0x23A0	EtherNet/IP
P508.00	Modbus comm.	No action [0]	Selection list	0x2320	Modbus RTU
P508.00	MBTCP comm.	No action [0]	Selection list	0x23B0	Modbus TCP/IP
P508.00	PROFINET comm.	No action [0]	Selection list	0x2380	PROFINET
P509.00	CANopen switch	-	-(Read only)	0x2303	CANopen
P509.00	EtherC. switch	-	-(Read only)	0x2363	EtherCAT
P509.00	EtherN. switch	-	-(Read only)	0x23A3	EtherNet/IP
P509.00	Modbus switch	-	-(Read only)	0x2323	Modbus RTU
P509.00	Switch position	-	-(Read only)	0x23B3	Modbus TCP/IP
P509.00	PROFIBUS switch	-	-(Read only)	0x2343	PROFIBUS
P510.xx	CANopen sett.				
└ P510.01	Node ID	1	1 ... 127	0x2301:001	CANopen
└ P510.02	Baud rate	500 kbps [5]	Selection list	0x2301:002	CANopen
└ P510.03	Slave/Master	Slave [0]	Selection list	0x2301:003	CANopen
└ P510.04	Start rem. delay	3000 ms	0 ... 65535 ms	0x2301:004	CANopen
└ P510.05	SDO2 channel	Not active [0]	Selection list	0x2301:005	CANopen
└ P510.06	COB-ID Config	Base + node-ID [0]	Selection list	0x2301:006	CANopen
P510.xx	EtherCAT sett.				
└ P510.04	Device ident.	0	0 ... 65535	0x2361:004	EtherCAT
P510.xx	EtherN/IP sett.				
└ P510.01	IP address	276605120	0 ... 4294967295	0x23A1:001	EtherNet/IP
└ P510.02	Subnet	16777215	0 ... 4294967295	0x23A1:002	EtherNet/IP
└ P510.03	Gateway	0	0 ... 4294967295	0x23A1:003	EtherNet/IP
└ P510.04	Host name		Text	0x23A1:004	EtherNet/IP
└ P510.05	IP configuration	BOOTP [1]	Selection list	0x23A1:005	EtherNet/IP
└ P510.06	Multicast TTL	1	0 ... 255	0x23A1:006	EtherNet/IP
└ P510.07	Mcast allocation	Default alloc. [0]	Selection list	0x23A1:007	EtherNet/IP
└ P510.08	Mcast IP addr.	3221373167	0 ... 4294967295	0x23A1:008	EtherNet/IP
└ P510.09	Multicast number	1	1 ... 8	0x23A1:009	EtherNet/IP
└ P510.10	Timeout	10000 ms	500 ... 65535 ms	0x23A1:010	EtherNet/IP
P510.xx	Modbus sett.				
└ P510.01	Node ID	1	1 ... 247	0x2321:001	Modbus RTU
└ P510.02	Baud rate	Automatic [0]	Selection list	0x2321:002	Modbus RTU
└ P510.03	Data format	Automatic [0]	Selection list	0x2321:003	Modbus RTU
└ P510.04	Min. resp. time	0 ms	0 ... 1000 ms	0x2321:004	Modbus RTU
P510.xx	MBTCP settings				
└ P510.01	IP address	276605120	0 ... 4294967295	0x23B1:001	Modbus TCP/IP
└ P510.02	Subnet	16777215	0 ... 4294967295	0x23B1:002	Modbus TCP/IP
└ P510.03	Gateway	0	0 ... 4294967295	0x23B1:003	Modbus TCP/IP
└ P510.05	IP configuration	Stored IP [0]	Selection list	0x23B1:005	Modbus TCP/IP
└ P510.06	TTL value	1	1 ... 255	0x23B1:006	Modbus TCP/IP
└ P510.10	Ethernet timeout	10000 ms	500 ... 65535 ms	0x23B1:010	Modbus TCP/IP
└ P510.11	Secondary port	502	0 ... 65535	0x23B1:011	Modbus TCP/IP
P510.xx	PROFIBUS sett.				
└ P510.01	Station address	3	1 ... 125	0x2341:001	PROFIBUS
P510.xx	PROFINET sett.				
└ P510.01	IP address	0	0 ... 4294967295	0x2381:001	PROFINET
└ P510.02	Subnet	0	0 ... 4294967295	0x2381:002	PROFINET
└ P510.03	Gateway	0	0 ... 4294967295	0x2381:003	PROFINET
└ P510.04	Station name		Text	0x2381:004	PROFINET
P511.xx	CANopen diag.				
└ P511.01	Active node ID	-	-(Read only)	0x2302:001	CANopen

* Default setting depending on the size.

Firmware version 04.00.00.00

Commissioning

Keypad parameter list



Display code	Short designation	Default setting	Setting range	Address	Category
↳ P511.02	Active baud rate	-	-(Read only)	0x2302:002	CANopen
P511.xx	EtherCAT diag.				
↳ P511.04	Device ident.	-	-(Read only)	0x2362:004	EtherCAT
↳ P511.06	Station address	-	-(Read only)	0x2362:006	EtherCAT
↳ P511.07	Tx length	-	-(Read only)	0x2362:007	EtherCAT
↳ P511.08	Rx length	-	-(Read only)	0x2362:008	EtherCAT
P511.xx	EtherN/IP diag.				
↳ P511.01	IP address	-	-(Read only)	0x23A2:001	EtherNet/IP
↳ P511.02	Subnet	-	-(Read only)	0x23A2:002	EtherNet/IP
↳ P511.03	Gateway	-	-(Read only)	0x23A2:003	EtherNet/IP
↳ P511.05	MAC address	-	-(Read only)	0x23A2:005	EtherNet/IP
↳ P511.06	Mcast address	-	-(Read only)	0x23A2:006	EtherNet/IP
P511.xx	Modbus diag.				
↳ P511.01	Active node ID	-	-(Read only)	0x2322:001	Modbus RTU
↳ P511.02	Active baud rate	-	-(Read only)	0x2322:002	Modbus RTU
↳ P511.03	Data format	-	-(Read only)	0x2322:003	Modbus RTU
P511.xx	Act. MBTCP sett.				
↳ P511.01	Act. IP address	-	-(Read only)	0x23B2:001	Modbus TCP/IP
↳ P511.02	Act. subnet	-	-(Read only)	0x23B2:002	Modbus TCP/IP
↳ P511.03	Act. gateway	-	-(Read only)	0x23B2:003	Modbus TCP/IP
↳ P511.05	MAC address	-	-(Read only)	0x23B2:005	Modbus TCP/IP
P511.xx	PROFIBUS diag.				
↳ P511.01	Act. station addr	-	-(Read only)	0x2342:001	PROFIBUS
↳ P511.02	Active baud rate	-	-(Read only)	0x2342:002	PROFIBUS
↳ P511.03	Watchdog time	-	-(Read only)	0x2342:003	PROFIBUS
P511.xx	PROFINET diag.				
↳ P511.01	IP address	-	-(Read only)	0x2382:001	PROFINET
↳ P511.02	Subnet	-	-(Read only)	0x2382:002	PROFINET
↳ P511.03	Gateway	-	-(Read only)	0x2382:003	PROFINET
↳ P511.04	Station name	-	-(Read only)	0x2382:004	PROFINET
↳ P511.05	MAC Address	-	-(Read only)	0x2382:005	PROFINET
P512.xx	Port settings				
↳ P512.01	Port 1	Auto-Negotiation [0]	Selection list	0x23A4:001	EtherNet/IP
↳ P512.02	Port 2	Auto-Negotiation [0]	Selection list	0x23A4:002	EtherNet/IP
P512.xx	Port settings				
↳ P512.01	Port 1	Auto-Negotiation [0]	Selection list	0x23B4:001	Modbus TCP/IP
↳ P512.02	Port 2	Auto-Negotiation [0]	Selection list	0x23B4:002	Modbus TCP/IP
P512.xx	PROFIBUS Config.				
↳ P512.01	Ext. diag. bit	Delete [0]	Selection list	0x2344:001	PROFIBUS
P513.00	QualityOfService	-	-(Read only)	0x23A6	EtherNet/IP
P513.xx	Act. port sett.				
↳ P513.01	Port 1	-	-(Read only)	0x23B5:001	Modbus TCP/IP
↳ P513.02	Port 2	-	-(Read only)	0x23B5:002	Modbus TCP/IP
P514.00	AddrConflictDetec	Enabled [1]	Selection list	0x23A7	EtherNet/IP
P514.xx	MBTCP t-out mon				
↳ P514.01	Time-out time	2.0 s	0.0 ... 300.0 s	0x23B6:001	Modbus TCP/IP
↳ P514.02	Keep al t-out	2.0 s	0.0 ... 300.0 s	0x23B6:002	Modbus TCP/IP
↳ P514.05	Keep al register	0	0 ... 65535	0x23B6:005	Modbus TCP/IP
P515.00	Time-out status	-	-(Read only)	0x2307	CANopen
P515.xx	EtherCAT monit.				
↳ P515.01	WD elapsed	Trouble [2]	Selection list	0x2859:001	EtherCAT
↳ P515.03	Invalid config	Trouble [2]	Selection list	0x2859:003	EtherCAT
↳ P515.04	Init. error	Trouble [2]	Selection list	0x2859:004	EtherCAT
↳ P515.05	Inval. proc.data	Trouble [2]	Selection list	0x2859:005	EtherCAT

* Default setting depending on the size.

Firmware version 04.00.00.00

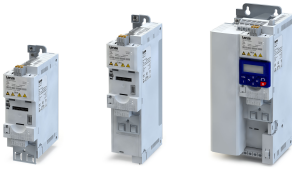

Commissioning

Keypad parameter list

Display code	Short designation	Default setting	Setting range	Address	Category
P515.xx	EtherN/IP monit.				
↳ P515.01	WD elapsed	Trouble [2]	Selection list	0x2859:001	EtherNet/IP
↳ P515.03	Invalid config	Trouble [2]	Selection list	0x2859:003	EtherNet/IP
↳ P515.04	Init. error	Trouble [2]	Selection list	0x2859:004	EtherNet/IP
↳ P515.05	Inval. proc.data	Trouble [2]	Selection list	0x2859:005	EtherNet/IP
↳ P515.06	Timeout ExplMsg	Warning [1]	Selection list	0x2859:006	EtherNet/IP
↳ P515.07	Timeout Comm.	Warning [1]	Selection list	0x2859:007	EtherNet/IP
P515.xx	Modbus monit.				
↳ P515.01	Resp. Time-out	Fault [3]	Selection list	0x2858:001	Modbus RTU
↳ P515.02	Time-out time	2.0 s	0.0 ... 300.0 s	0x2858:002	Modbus RTU
P515.xx	MBTCP monitoring				
↳ P515.03	Config error	Trouble [2]	Selection list	0x2859:003	Modbus TCP/IP
↳ P515.04	Init error	Trouble [2]	Selection list	0x2859:004	Modbus TCP/IP
↳ P515.07	React t-out netw	Warning [1]	Selection list	0x2859:007	Modbus TCP/IP
↳ P515.08	React t-out mast	Fault [3]	Selection list	0x2859:008	Modbus TCP/IP
↳ P515.09	Reac t-out kp-al	Fault [3]	Selection list	0x2859:009	Modbus TCP/IP
P515.xx	PROFIBUS monit.				
↳ P515.01	WD elapsed	Fault [3]	Selection list	0x2859:001	PROFIBUS
↳ P515.02	Data exch.exited	No response [0]	Selection list	0x2859:002	PROFIBUS
↳ P515.03	Invalid config	Fault [3]	Selection list	0x2859:003	PROFIBUS
↳ P515.04	Init. error	Fault [3]	Selection list	0x2859:004	PROFIBUS
↳ P515.05	Inval. proc.data	Trouble [2]	Selection list	0x2859:005	PROFIBUS
P515.xx	PROFINET monit.				
↳ P515.01	WD elapsed	Trouble [2]	Selection list	0x2859:001	PROFINET
↳ P515.03	Invalid config	Trouble [2]	Selection list	0x2859:003	PROFINET
↳ P515.04	Init. error	Trouble [2]	Selection list	0x2859:004	PROFINET
↳ P515.05	Inval. proc.data	Trouble [2]	Selection list	0x2859:005	PROFINET
P516.00	CANopen status	-	-(Read only)	0x2308	CANopen
P516.00	EtherCAT status	-	-(Read only)	0x2368	EtherCAT
P516.00	CIP module stat.	-	-(Read only)	0x23A8	EtherNet/IP
P516.00	MBTCP modul. stat	-	-(Read only)	0x23B8	Modbus TCP/IP
P516.xx	PROFIBUS Status				
↳ P516.01	Bus status	-	-(Read only)	0x2348:001	PROFIBUS
↳ P516.02	Watchdog status	-	-(Read only)	0x2348:002	PROFIBUS
P516.00	PROFINET status	-	-(Read only)	0x2388	PROFINET
P517.00	CAN contr.status	-	-(Read only)	0x2309	CANopen
P517.00	EtherCAT error	-	-(Read only)	0x2369	EtherCAT
P517.00	EtherN/IP status	-	-(Read only)	0x23A9	EtherNet/IP
P517.00	MBTCP netw stat	-	-(Read only)	0x23B9	Modbus TCP/IP
P517.00	PROFIBUS error	-	-(Read only)	0x2349	PROFIBUS
P517.xx	PROFINET error				
↳ P517.01	Error 1	-	-(Read only)	0x2389:001	PROFINET
↳ P517.02	Error2	-	-(Read only)	0x2389:002	PROFINET
P518.00	CAN errorcounter	-	-(Read only)	0x230B	CANopen
P519.xx	Port diagnostics				
↳ P519.01	Port 1	-	-(Read only)	0x23A5:001	EtherNet/IP
↳ P519.02	Port 2	-	-(Read only)	0x23A5:002	EtherNet/IP
P520.xx	Cons. heartbeat				
↳ P520.00	Highest subindex	-	-(Read only)	0x1016:000	CANopen
↳ P520.01	Cons. heartbeat1	0x00000000	0x00000000 ... 0x00FFFFFF	0x1016:001	CANopen
↳ P520.02	Cons. heartbeat2	0x00000000	0x00000000 ... 0x00FFFFFF	0x1016:002	CANopen
↳ P520.03	Cons. heartbeat3	0x00000000	0x00000000 ... 0x00FFFFFF	0x1016:003	CANopen
↳ P520.04	Cons. heartbeat4	0x00000000	0x00000000 ... 0x00FFFFFF	0x1016:004	CANopen
P522.00	Prod. heartbeat	0 ms	0 ... 65535 ms	0x1017	CANopen

* Default setting depending on the size.

Firmware version 04.00.00.00

Commissioning

Keypad parameter list



Display code	Short designation	Default setting	Setting range	Address	Category
P530.xx	Para. mapping				
↳ P530.01	Parameter 1	0x00000000	0x00000000 ... 0xFFFFFFFF00	0x232B:001	Modbus RTU
↳ P530.02	Parameter 2	0x00000000	0x00000000 ... 0xFFFFFFFF00	0x232B:002	Modbus RTU
↳ P530.03	Parameter 3	0x00000000	0x00000000 ... 0xFFFFFFFF00	0x232B:003	Modbus RTU
↳ P530.04	Parameter 4	0x00000000	0x00000000 ... 0xFFFFFFFF00	0x232B:004	Modbus RTU
↳ P530.05	Parameter 5	0x00000000	0x00000000 ... 0xFFFFFFFF00	0x232B:005	Modbus RTU
↳ P530.06	Parameter 6	0x00000000	0x00000000 ... 0xFFFFFFFF00	0x232B:006	Modbus RTU
↳ P530.07	Parameter 7	0x00000000	0x00000000 ... 0xFFFFFFFF00	0x232B:007	Modbus RTU
↳ P530.08	Parameter 8	0x00000000	0x00000000 ... 0xFFFFFFFF00	0x232B:008	Modbus RTU
↳ P530.09	Parameter 9	0x00000000	0x00000000 ... 0xFFFFFFFF00	0x232B:009	Modbus RTU
↳ P530.10	Parameter 10	0x00000000	0x00000000 ... 0xFFFFFFFF00	0x232B:010	Modbus RTU
↳ P530.11	Parameter 11	0x00000000	0x00000000 ... 0xFFFFFFFF00	0x232B:011	Modbus RTU
↳ P530.12	Parameter 12	0x00000000	0x00000000 ... 0xFFFFFFFF00	0x232B:012	Modbus RTU
↳ P530.13	Parameter 13	0x00000000	0x00000000 ... 0xFFFFFFFF00	0x232B:013	Modbus RTU
↳ P530.14	Parameter 14	0x00000000	0x00000000 ... 0xFFFFFFFF00	0x232B:014	Modbus RTU
↳ P530.15	Parameter 15	0x00000000	0x00000000 ... 0xFFFFFFFF00	0x232B:015	Modbus RTU
↳ P530.16	Parameter 16	0x00000000	0x00000000 ... 0xFFFFFFFF00	0x232B:016	Modbus RTU
↳ P530.17	Parameter 17	0x00000000	0x00000000 ... 0xFFFFFFFF00	0x232B:017	Modbus RTU
↳ P530.18	Parameter 18	0x00000000	0x00000000 ... 0xFFFFFFFF00	0x232B:018	Modbus RTU
↳ P530.19	Parameter 19	0x00000000	0x00000000 ... 0xFFFFFFFF00	0x232B:019	Modbus RTU
↳ P530.20	Parameter 20	0x00000000	0x00000000 ... 0xFFFFFFFF00	0x232B:020	Modbus RTU
↳ P530.21	Parameter 21	0x00000000	0x00000000 ... 0xFFFFFFFF00	0x232B:021	Modbus RTU
↳ P530.22	Parameter 22	0x00000000	0x00000000 ... 0xFFFFFFFF00	0x232B:022	Modbus RTU
↳ P530.23	Parameter 23	0x00000000	0x00000000 ... 0xFFFFFFFF00	0x232B:023	Modbus RTU
↳ P530.24	Parameter 24	0x00000000	0x00000000 ... 0xFFFFFFFF00	0x232B:024	Modbus RTU
P530.xx	MBTCP param.mapp				
↳ P530.01	Parameter 1	0x00000000	0x00000000 ... 0xFFFFFFFFFF	0x23BB:001	Modbus TCP/IP
↳ P530.02	Parameter 2	0x00000000	0x00000000 ... 0xFFFFFFFFFF	0x23BB:002	Modbus TCP/IP
↳ P530.03	Parameter 3	0x00000000	0x00000000 ... 0xFFFFFFFFFF	0x23BB:003	Modbus TCP/IP
↳ P530.04	Parameter 4	0x00000000	0x00000000 ... 0xFFFFFFFFFF	0x23BB:004	Modbus TCP/IP
↳ P530.05	Parameter 5	0x00000000	0x00000000 ... 0xFFFFFFFFFF	0x23BB:005	Modbus TCP/IP
↳ P530.06	Parameter 6	0x00000000	0x00000000 ... 0xFFFFFFFFFF	0x23BB:006	Modbus TCP/IP
↳ P530.07	Parameter 7	0x00000000	0x00000000 ... 0xFFFFFFFFFF	0x23BB:007	Modbus TCP/IP
↳ P530.08	Parameter 8	0x00000000	0x00000000 ... 0xFFFFFFFFFF	0x23BB:008	Modbus TCP/IP
↳ P530.09	Parameter 9	0x00000000	0x00000000 ... 0xFFFFFFFFFF	0x23BB:009	Modbus TCP/IP
↳ P530.10	Parameter 10	0x00000000	0x00000000 ... 0xFFFFFFFFFF	0x23BB:010	Modbus TCP/IP
↳ P530.11	Parameter 11	0x00000000	0x00000000 ... 0xFFFFFFFFFF	0x23BB:011	Modbus TCP/IP
↳ P530.12	Parameter 12	0x00000000	0x00000000 ... 0xFFFFFFFFFF	0x23BB:012	Modbus TCP/IP
↳ P530.13	Parameter 13	0x00000000	0x00000000 ... 0xFFFFFFFFFF	0x23BB:013	Modbus TCP/IP
↳ P530.14	Parameter 14	0x00000000	0x00000000 ... 0xFFFFFFFFFF	0x23BB:014	Modbus TCP/IP
↳ P530.15	Parameter 15	0x00000000	0x00000000 ... 0xFFFFFFFFFF	0x23BB:015	Modbus TCP/IP
↳ P530.16	Parameter 16	0x00000000	0x00000000 ... 0xFFFFFFFFFF	0x23BB:016	Modbus TCP/IP
↳ P530.17	Parameter 17	0x00000000	0x00000000 ... 0xFFFFFFFFFF	0x23BB:017	Modbus TCP/IP
↳ P530.18	Parameter 18	0x00000000	0x00000000 ... 0xFFFFFFFFFF	0x23BB:018	Modbus TCP/IP
↳ P530.19	Parameter 19	0x00000000	0x00000000 ... 0xFFFFFFFFFF	0x23BB:019	Modbus TCP/IP
↳ P530.20	Parameter 20	0x00000000	0x00000000 ... 0xFFFFFFFFFF	0x23BB:020	Modbus TCP/IP
↳ P530.21	Parameter 21	0x00000000	0x00000000 ... 0xFFFFFFFFFF	0x23BB:021	Modbus TCP/IP
↳ P530.22	Parameter 22	0x00000000	0x00000000 ... 0xFFFFFFFFFF	0x23BB:022	Modbus TCP/IP
↳ P530.23	Parameter 23	0x00000000	0x00000000 ... 0xFFFFFFFFFF	0x23BB:023	Modbus TCP/IP
↳ P530.24	Parameter 24	0x00000000	0x00000000 ... 0xFFFFFFFFFF	0x23BB:024	Modbus TCP/IP
P531.xx	Reg. assigned				
↳ P531.01	Register 1	-	-(Read only)	0x232C:001	Modbus RTU
↳ P531.02	Register 2	-	-(Read only)	0x232C:002	Modbus RTU
↳ P531.03	Register 3	-	-(Read only)	0x232C:003	Modbus RTU

* Default setting depending on the size.

Firmware version 04.00.00.00

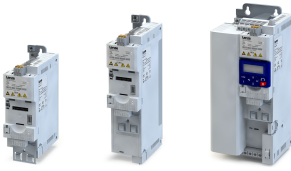

Commissioning

Keypad parameter list

Display code	Short designation	Default setting	Setting range	Address	Category
L P531.04	Register 4	-	-(Read only)	0x232C:004	Modbus RTU
L P531.05	Register 5	-	-(Read only)	0x232C:005	Modbus RTU
L P531.06	Register 6	-	-(Read only)	0x232C:006	Modbus RTU
L P531.07	Register 7	-	-(Read only)	0x232C:007	Modbus RTU
L P531.08	Register 8	-	-(Read only)	0x232C:008	Modbus RTU
L P531.09	Register 9	-	-(Read only)	0x232C:009	Modbus RTU
L P531.10	Register 10	-	-(Read only)	0x232C:010	Modbus RTU
L P531.11	Register 11	-	-(Read only)	0x232C:011	Modbus RTU
L P531.12	Register 12	-	-(Read only)	0x232C:012	Modbus RTU
L P531.13	Register 13	-	-(Read only)	0x232C:013	Modbus RTU
L P531.14	Register 14	-	-(Read only)	0x232C:014	Modbus RTU
L P531.15	Register 15	-	-(Read only)	0x232C:015	Modbus RTU
L P531.16	Register 16	-	-(Read only)	0x232C:016	Modbus RTU
L P531.17	Register 17	-	-(Read only)	0x232C:017	Modbus RTU
L P531.18	Register 18	-	-(Read only)	0x232C:018	Modbus RTU
L P531.19	Register 19	-	-(Read only)	0x232C:019	Modbus RTU
L P531.20	Register 20	-	-(Read only)	0x232C:020	Modbus RTU
L P531.21	Register 21	-	-(Read only)	0x232C:021	Modbus RTU
L P531.22	Register 22	-	-(Read only)	0x232C:022	Modbus RTU
L P531.23	Register 23	-	-(Read only)	0x232C:023	Modbus RTU
L P531.24	Register 24	-	-(Read only)	0x232C:024	Modbus RTU
P531.xx	Register assignm				
L P531.01	Register 1	-	-(Read only)	0x23BC:001	Modbus TCP/IP
L P531.02	Register 2	-	-(Read only)	0x23BC:002	Modbus TCP/IP
L P531.03	Register 3	-	-(Read only)	0x23BC:003	Modbus TCP/IP
L P531.04	Register 4	-	-(Read only)	0x23BC:004	Modbus TCP/IP
L P531.05	Register 5	-	-(Read only)	0x23BC:005	Modbus TCP/IP
L P531.06	Register 6	-	-(Read only)	0x23BC:006	Modbus TCP/IP
L P531.07	Register 7	-	-(Read only)	0x23BC:007	Modbus TCP/IP
L P531.08	Register 8	-	-(Read only)	0x23BC:008	Modbus TCP/IP
L P531.09	Register 9	-	-(Read only)	0x23BC:009	Modbus TCP/IP
L P531.10	Register 10	-	-(Read only)	0x23BC:010	Modbus TCP/IP
L P531.11	Register 11	-	-(Read only)	0x23BC:011	Modbus TCP/IP
L P531.12	Register 12	-	-(Read only)	0x23BC:012	Modbus TCP/IP
L P531.13	Register 13	-	-(Read only)	0x23BC:013	Modbus TCP/IP
L P531.14	Register 14	-	-(Read only)	0x23BC:014	Modbus TCP/IP
L P531.15	Register 15	-	-(Read only)	0x23BC:015	Modbus TCP/IP
L P531.16	Register 16	-	-(Read only)	0x23BC:016	Modbus TCP/IP
L P531.17	Register 17	-	-(Read only)	0x23BC:017	Modbus TCP/IP
L P531.18	Register 18	-	-(Read only)	0x23BC:018	Modbus TCP/IP
L P531.19	Register 19	-	-(Read only)	0x23BC:019	Modbus TCP/IP
L P531.20	Register 20	-	-(Read only)	0x23BC:020	Modbus TCP/IP
L P531.21	Register 21	-	-(Read only)	0x23BC:021	Modbus TCP/IP
L P531.22	Register 22	-	-(Read only)	0x23BC:022	Modbus TCP/IP
L P531.23	Register 23	-	-(Read only)	0x23BC:023	Modbus TCP/IP
L P531.24	Register 24	-	-(Read only)	0x23BC:024	Modbus TCP/IP
P532.00	Verificationcode	-	-(Read only)	0x232D	Modbus RTU
P532.00	Verificat. code	-	-(Read only)	0x23BD	Modbus TCP/IP
P540.xx	RPDO1 config.				
L P540.01	COB-ID	0x00000200	0x00000000 ... 0xFFFFFFFF	0x1400:001	CANopen
L P540.02	Transm. type	255	0 ... 255	0x1400:002	CANopen
L P540.05	Event timer	100 ms	0 ... 65535 ms	0x1400:005	CANopen
P541.xx	RPDO2 config.				
L P541.01	COB-ID	0x80000300	0x00000000 ... 0xFFFFFFFF	0x1401:001	CANopen

* Default setting depending on the size.

Firmware version 04.00.00.00

Commissioning

Keypad parameter list



Display code	Short designation	Default setting	Setting range	Address	Category
↳ P541.02	Transm. type	255	0 ... 255	0x1401:002	CANopen
↳ P541.05	Event timer	100 ms	0 ... 65535 ms	0x1401:005	CANopen
P542.xx	RPDO3 config.				
↳ P542.01	COB-ID	0x80000400	0x00000000 ... 0xFFFFFFFF	0x1402:001	CANopen
↳ P542.02	Transm. type	255	0 ... 255	0x1402:002	CANopen
↳ P542.05	Event timer	100 ms	0 ... 65535 ms	0x1402:005	CANopen
P550.xx	TPDO1 config.				
↳ P550.01	COB-ID	0x40000180	0x00000001 ... 0xFFFFFFFF	0x1800:001	CANopen
↳ P550.02	Transm. type	255	0 ... 255	0x1800:002	CANopen
↳ P550.03	Inhibit time	0.0 ms	0.0 ... 6553.5 ms	0x1800:003	CANopen
↳ P550.05	Event timer	20 ms	0 ... 65535 ms	0x1800:005	CANopen
P551.xx	TPDO2 config.				
↳ P551.01	COB-ID	0xC0000280	0x00000001 ... 0xFFFFFFFF	0x1801:001	CANopen
↳ P551.02	Transm. type	255	0 ... 255	0x1801:002	CANopen
↳ P551.03	Inhibit time	0.0 ms	0.0 ... 6553.5 ms	0x1801:003	CANopen
↳ P551.05	Event timer	0 ms	0 ... 65535 ms	0x1801:005	CANopen
P552.xx	TPDO3 config.				
↳ P552.01	COB-ID	0xC0000380	0x00000001 ... 0xFFFFFFFF	0x1802:001	CANopen
↳ P552.02	Transm. type	255	0 ... 255	0x1802:002	CANopen
↳ P552.03	Inhibit time	0.0 ms	0.0 ... 6553.5 ms	0x1802:003	CANopen
↳ P552.05	Event timer	0 ms	0 ... 65535 ms	0x1802:005	CANopen
P580.xx	CAN statistics				
↳ P580.01	PDO1 received	-	-(Read only)	0x230A:001	CANopen
↳ P580.02	PDO2 received	-	-(Read only)	0x230A:002	CANopen
↳ P580.03	PDO3 received	-	-(Read only)	0x230A:003	CANopen
↳ P580.05	PDO1 transmitted	-	-(Read only)	0x230A:005	CANopen
↳ P580.06	PDO2 transmitted	-	-(Read only)	0x230A:006	CANopen
↳ P580.07	PDO3 transmitted	-	-(Read only)	0x230A:007	CANopen
↳ P580.09	SDO1 counter	-	-(Read only)	0x230A:009	CANopen
↳ P580.10	SDO2 counter	-	-(Read only)	0x230A:010	CANopen
P580.xx	Modbus statistic				
↳ P580.01	Mess. received	-	-(Read only)	0x232A:001	Modbus RTU
↳ P580.02	Val. mess. rec.	-	-(Read only)	0x232A:002	Modbus RTU
↳ P580.03	Mess. w. exc.	-	-(Read only)	0x232A:003	Modbus RTU
↳ P580.04	Mess. w. errors	-	-(Read only)	0x232A:004	Modbus RTU
↳ P580.05	Messages sent	-	-(Read only)	0x232A:005	Modbus RTU
P580.xx	MBTCP statistics				
↳ P580.01	Rx messages	-	-(Read only)	0x23BA:001	Modbus TCP/IP
↳ P580.02	Valid Rx messag.	-	-(Read only)	0x23BA:002	Modbus TCP/IP
↳ P580.03	Mess. w. except	-	-(Read only)	0x23BA:003	Modbus TCP/IP
↳ P580.05	Tx messages	-	-(Read only)	0x23BA:005	Modbus TCP/IP
P580.xx	PROFIBUS counter				
↳ P580.01	Data cycles/sec.	-	-(Read only)	0x234A:001	PROFIBUS
↳ P580.02	PRM events	-	-(Read only)	0x234A:002	PROFIBUS
↳ P580.03	CFG events	-	-(Read only)	0x234A:003	PROFIBUS
↳ P580.04	DIAG events	-	-(Read only)	0x234A:004	PROFIBUS
↳ P580.05	C1 messages	-	-(Read only)	0x234A:005	PROFIBUS
↳ P580.06	C2 messages	-	-(Read only)	0x234A:006	PROFIBUS
↳ P580.07	WD events	-	-(Read only)	0x234A:007	PROFIBUS
↳ P580.08	DataEx.event	-	-(Read only)	0x234A:008	PROFIBUS
↳ P580.09	Tot. data cycles	-	-(Read only)	0x234A:009	PROFIBUS
P583.xx	Rx data diagn.				
↳ P583.01	Rx data offset	0	0 ... 240	0x232E:001	Modbus RTU
↳ P583.02	Last RxD byte0	-	-(Read only)	0x232E:002	Modbus RTU

* Default setting depending on the size.

Firmware version 04.00.00.00

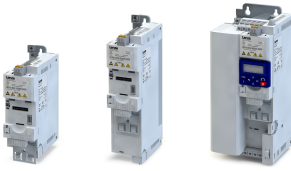

Commissioning

Keypad parameter list

Display code	Short designation	Default setting	Setting range	Address	Category
↳ P583.03	Last RxD byte1	-	-(Read only)	0x232E:003	Modbus RTU
↳ P583.04	Last RxD byte2	-	-(Read only)	0x232E:004	Modbus RTU
↳ P583.05	Last RxD byte3	-	-(Read only)	0x232E:005	Modbus RTU
↳ P583.06	Last RxD byte4	-	-(Read only)	0x232E:006	Modbus RTU
↳ P583.07	Letzt RxD-Byte5	-	-(Read only)	0x232E:007	Modbus RTU
↳ P583.08	Last RxD byte6	-	-(Read only)	0x232E:008	Modbus RTU
↳ P583.09	Last RxD byte7	-	-(Read only)	0x232E:009	Modbus RTU
↳ P583.10	Last RxD byte8	-	-(Read only)	0x232E:010	Modbus RTU
↳ P583.11	Last RxD byte9	-	-(Read only)	0x232E:011	Modbus RTU
↳ P583.12	Last RxD byte10	-	-(Read only)	0x232E:012	Modbus RTU
↳ P583.13	Last RxD byte11	-	-(Read only)	0x232E:013	Modbus RTU
↳ P583.14	Last RxD byte12	-	-(Read only)	0x232E:014	Modbus RTU
↳ P583.15	Last RxD byte13	-	-(Read only)	0x232E:015	Modbus RTU
↳ P583.16	Last RxD byte14	-	-(Read only)	0x232E:016	Modbus RTU
↳ P583.17	Last RxD byte15	-	-(Read only)	0x232E:017	Modbus RTU
P585.xx	Tx data diagn.				
↳ P585.01	Tx data offset	0	0 ... 240	0x232F:001	Modbus RTU
↳ P585.02	Last TxD byte0	-	-(Read only)	0x232F:002	Modbus RTU
↳ P585.03	Last TxD Byte1	-	-(Read only)	0x232F:003	Modbus RTU
↳ P585.04	Last TxD byte2	-	-(Read only)	0x232F:004	Modbus RTU
↳ P585.05	Last TxD byte3	-	-(Read only)	0x232F:005	Modbus RTU
↳ P585.06	Last TxD byte4	-	-(Read only)	0x232F:006	Modbus RTU
↳ P585.07	Last TxD byte5	-	-(Read only)	0x232F:007	Modbus RTU
↳ P585.08	Last TxD byte6	-	-(Read only)	0x232F:008	Modbus RTU
↳ P585.09	Last TxD byte7	-	-(Read only)	0x232F:009	Modbus RTU
↳ P585.10	Last TxD byte8	-	-(Read only)	0x232F:010	Modbus RTU
↳ P585.11	Last TxD byte9	-	-(Read only)	0x232F:011	Modbus RTU
↳ P585.12	Last TxD byte10	-	-(Read only)	0x232F:012	Modbus RTU
↳ P585.13	Last TxD byte11	-	-(Read only)	0x232F:013	Modbus RTU
↳ P585.14	Last TxD byte12	-	-(Read only)	0x232F:014	Modbus RTU
↳ P585.15	Last TxD byte13	-	-(Read only)	0x232F:015	Modbus RTU
↳ P585.16	Last TxD byte14	-	-(Read only)	0x232F:016	Modbus RTU
↳ P585.17	Last TxD byte15	-	-(Read only)	0x232F:017	Modbus RTU
P585.xx	MBTCP Tx/Rx diag				
↳ P585.01	Rx offset	0	0 ... 240	0x23BE:001	Modbus TCP/IP
↳ P585.02	Last Rx message	-	-(Read only)	0x23BE:002	Modbus TCP/IP
↳ P585.03	Tx offset	0	0 ... 240	0x23BE:003	Modbus TCP/IP
↳ P585.04	Last Tx message	-	-(Read only)	0x23BE:004	Modbus TCP/IP
P590.xx	NetWordINx				
↳ P590.01	NetWordIN1	0x0000	0x0000 ... 0xFFFF	0x4008:001	general
↳ P590.02	NetWordIN2	0x0000	0x0000 ... 0xFFFF	0x4008:002	general
↳ P590.03	NetWordIN3	0.0 %	0.0 ... 100.0 %	0x4008:003	general
↳ P590.04	NetWordIN4	0.0 %	0.0 ... 100.0 %	0x4008:004	general
P591.xx	NetWordOUTx				
↳ P591.01	NetWordOUT1	-	-(Read only)	0x400A:001	general
↳ P591.02	NetWordOUT2	-	-(Read only)	0x400A:002	general
P592.xx	Process data IN				
↳ P592.01	AC control word	0x0000	0x0000 ... 0xFFFF	0x400B:001	general
↳ P592.02	LECOM ctrl word	0x0000	0x0000 ... 0xFFFF	0x400B:002	general
↳ P592.03	Net.freq. 0.1	0.0 Hz	0.0 ... 599.0 Hz	0x400B:003	general
↳ P592.04	Net.setp. speed	0 rpm	0 ... 50000 rpm	0x400B:004	general
↳ P592.05	Net.freq. 0.01	0.00 Hz	0.00 ... 599.00 Hz	0x400B:005	general
↳ P592.06	Veloc. mode setp	0.0 Hz	-599.0 ... 599.0 Hz	0x400B:006	general
↳ P592.07	PID setpoint	0.00 PID unit	-300.00 ... 300.00 PID unit	0x400B:007	general

* Default setting depending on the size.

Firmware version 04.00.00.00

Commissioning

Keypad parameter list



Display code	Short designation	Default setting	Setting range	Address	Category
↳ P592.08	Torque mode setp	0 Nm	-32768 ... 32767 Nm	0x400B:008	general
↳ P592.09	Torque scaling	0	-128 ... 127	0x400B:009	general
↳ P592.11	PID feedback	0.00 PID unit	-300.00 ... 300.00 PID unit	0x400B:011	general
↳ P592.12	NetSetfreq0.02Hz	0 Hz	-29950 ... 29950 Hz	0x400B:012	general
P593.xx	Process data OUT				
↳ P593.01	AC status word	-	- (Read only)	0x400C:001	general
↳ P593.02	LECOM stat. word	-	- (Read only)	0x400C:002	general
↳ P593.03	Frequency (0.1)	x.x Hz	- (Read only)	0x400C:003	general
↳ P593.04	Motor speed	x rpm	- (Read only)	0x400C:004	general
↳ P593.05	Drive status	-	- (Read only)	0x400C:005	general
↳ P593.06	Frequency 0.01	x.xx Hz	- (Read only)	0x400C:006	general
↳ P593.07	Torque scaled	-	- (Read only)	0x400C:007	general
↳ P593.08	Frequency 0.02Hz	Hz	- (Read only)	0x400C:008	general
P595.xx	PAM monitoring				
↳ P595.02	Keep alive reg.	0	0 ... 65535	0x2552:002	general
↳ P595.03	Time-out time	10.0 s	0.0 ... 6553.5 s	0x2552:003	general
↳ P595.04	Reaction	No response [0]	Selection list	0x2552:004	general
↳ P595.05	Action	No action [0]	Selection list	0x2552:005	general
↳ P595.06	PAM status	-	- (Read only)	0x2552:006	general
P600.xx	PID setup				
↳ P600.01	Operating mode	Inhibited [0]	Selection list	0x4020:001	general
↳ P600.02	PID process var.	Analog input 1 [1]	Selection list	0x4020:002	general
↳ P600.03	PID speed range	100 %	0 ... 100 %	0x4020:003	general
↳ P600.04	PID line speed	w/o speed.add. [0]	Selection list	0x4020:004	general
↳ P600.05	Min speed lim	-100.0 %	-100.0 ... 100.0 %	0x4020:005	general
↳ P600.06	Max speed lim	100.0 %	-100.0 ... 100.0 %	0x4020:006	general
P601.00	PID P-component	5.0 %	0.0 ... 1000.0 %	0x4048	general
P602.00	PID I- component	400 ms	10 ... 6000 ms	0x4049	general
P603.00	PID D-component	0.0 s	0.0 ... 20.0 s	0x404A	general
P604.00	PID setp.ramp	20.0 s	0.0 ... 100.0 s	0x404B	general
P605.xx	PID setp. limit				
↳ P605.01	Minimum setpoint	-300.00 PID unit	-300.00 ... 300.00 PID unit	0x404E:001	general
↳ P605.02	Maximum setpoint	300.00 PID unit	-300.00 ... 300.00 PID unit	0x404E:002	general
P606.xx	PID speed op.				
↳ P606.01	Accel. time	1.0 s	0.0 ... 3600.0 s	0x4021:001	general
↳ P606.02	Decel. time	1.0 s	0.0 ... 3600.0 s	0x4021:002	general
P607.xx	PID influence				
↳ P607.01	Show time	5.0 s	0.0 ... 999.9 s	0x404C:001	general
↳ P607.02	Mask out time	5.0 s	0.0 ... 999.9 s	0x404C:002	general
P608.xx	PID alarms				
↳ P608.01	MIN alarm thrsh.	0.00 PID unit	-300.00 ... 300.00 PID unit	0x404D:001	general
↳ P608.02	MAX alarm thrsh.	100.00 PID unit	-300.00 ... 300.00 PID unit	0x404D:002	general
↳ P608.03	Bandw. feedback	2.00 %	0.00 ... 100.00 %	0x404D:003	general
P610.xx	PID sleep mode				
↳ P610.01	Activation	Disabled [0]	Selection list	0x4023:001	general
↳ P610.02	Stop method	Coasting [0]	Selection list	0x4023:002	general
↳ P610.03	Freq. thresh.	0.0 Hz	0.0 ... 599.0 Hz	0x4023:003	general
↳ P610.04	Feedback thresh.	0.00 PID unit	-300.00 ... 300.00 PID unit	0x4023:004	general
↳ P610.05	Delay time	0.0 s	0.0 ... 300.0 s	0x4023:005	general
↳ P610.06	Recovery	Setp. > P610.3 [0]	Selection list	0x4023:006	general
↳ P610.07	Bandwidth	0.00 PID unit	0.00 ... 300.00 PID unit	0x4023:007	general
↳ P610.08	Recovery thresh.	0.00 PID unit	-300.00 ... 300.00 PID unit	0x4023:008	general
P615.xx	Auto-rinsing				
↳ P615.01	Rinsing in idle	Inhibited [0]	Selection list	0x4024:001	general

* Default setting depending on the size.

Firmware version 04.00.00.00

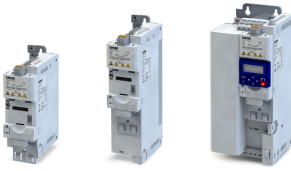

Commissioning

Keypad parameter list

Display code	Short designation	Default setting	Setting range	Address	Category
L P615.02	Rinse interval	30.0 min	0.0 ... 6000.0 min	0x4024:002	general
L P615.03	Rinse speed	0.0 Hz	-599.0 ... 599.0 Hz	0x4024:003	general
L P615.04	Rinse period	0.0 s	0.0 ... 6000.0 s	0x4024:004	general
P700.xx	Device commands				
L P700.01	Load def. sett.	Off / ready [0]	Selection list	0x2022:001	general
L P700.03	Save user data	Off / ready [0]	Selection list	0x2022:003	general
L P700.04	Load user data	Off / ready [0]	Selection list	0x2022:004	general
L P700.05	Load OEM data	Off / ready [0]	Selection list	0x2022:005	general
L P700.06	Save OEM data	Off / ready [0]	Selection list	0x2022:006	general
L P700.07	Load par. set 1	Off / ready [0]	Selection list	0x2022:007	general
L P700.08	Load par. set 2	Off / ready [0]	Selection list	0x2022:008	general
L P700.09	Load par. set 3	Off / ready [0]	Selection list	0x2022:009	general
L P700.10	Load par. set 4	Off / ready [0]	Selection list	0x2022:010	general
L P700.11	Save par. set 1	Off / ready [0]	Selection list	0x2022:011	general
L P700.12	Save par. set 2	Off / ready [0]	Selection list	0x2022:012	general
L P700.13	Save par. set 3	Off / ready [0]	Selection list	0x2022:013	general
L P700.14	Save par. set 4	Off / ready [0]	Selection list	0x2022:014	general
L P700.15	Delete logbook	Off / ready [0]	Selection list	0x2022:015	general
P701.00	KP setp. incr.	1	1 ... 100	0x2862	general
P702.00	Scal.speed fact.	0.00	0.00 ... 650.00	0x4002	general
P703.00	KP status displ.	0x00000000	0x00000000 ... 0xFFFFFFFF00	0x2864	general
P704.xx	DC braking				
L P704.01	Current	0.0 %	0.0 ... 200.0 %	0x2B84:001	general
L P704.02	Hold time autom.	0.0 s	0.0 ... 1000.0 s	0x2B84:002	general
L P704.03	Threshold autom.	0.0 Hz	0.0 ... 599.0 Hz	0x2B84:003	general
L P704.04	Demagnet. time	100 %	0 ... 150 %	0x2B84:004	general
L P704.05	Def. demag. time	x ms	- (Read only)	0x2B84:005	general
P705.00	KP language	English [1]	Selection list	0x2863	general
P706.xx	Brake management				
L P706.01	Operating mode	Rfg stop (RFGS) [1]	Selection list	0x2541:001	general
L P706.02	Active threshold	x V	- (Read only)	0x2541:002	general
L P706.03	Red. threshold	0 V	0 ... 100 V	0x2541:003	general
L P706.04	Add.frequency	0.0 Hz	0.0 ... 10.0 Hz	0x2541:004	general
L P706.05	Del.overr.time	2.0 s	0.0 ... 60.0 s	0x2541:005	general
L P706.06	Brk. res. behav	Off:disabl+error [0]	Selection list	0x2541:006	general
P707.xx	Brake resistor				
L P707.02	Resistance value	180.0 Ω *	0.0 ... 500.0 Ω	0x2550:002	general
L P707.03	Rated power	50 W *	0 ... 800000 W	0x2550:003	general
L P707.04	Maximum heat	8.0 kW * *	0.0 ... 100000.0 kW	0x2550:004	general
L P707.07	Thermal load	x.x %	- (Read only)	0x2550:007	general
L P707.08	Warning thresh.	90.0 %	50.0 ... 150.0 %	0x2550:008	general
L P707.09	Error thresh.	100.0 %	50.0 ... 150.0 %	0x2550:009	general
L P707.10	Warning resp.	Warning [1]	Selection list	0x2550:010	general
L P707.11	Error response	Fault [3]	Selection list	0x2550:011	general
P708.xx	Keypad setup				
L P708.01	CTRL&F/R keys	CTRL&F/R Enable [1]	Selection list	0x2602:001	general
L P708.02	Rotation setup	Forward [0]	Selection list	0x2602:002	general
L P708.03	Keypad Full Ctrl	Off [0]	Selection list	0x2602:003	general
P710.xx	Load loss detect				
L P710.01	Threshold	0.0 %	0.0 ... 200.0 %	0x4006:001	general
L P710.02	Deceleration	0.0 s	0.0 ... 300.0 s	0x4006:002	general
P711.xx	Position counter				
L P711.01	Signal source	Disbled [0]	Selection list	0x2C49:001	general
L P711.02	Reset mode	Rising edge [0]	Selection list	0x2C49:002	general

* Default setting depending on the size.

Firmware version 04.00.00.00

Commissioning

Keypad parameter list



Display code	Short designation	Default setting	Setting range	Address	Category
↳ P711.03	Actual position	-	-(Read only)	0x2C49:003	general
P712.xx	Brake control				
↳ P712.01	Brake mode	Off [2]	Selection list	0x2820:001	general
↳ P712.02	Closing time	100 ms	0 ... 10000 ms	0x2820:002	general
↳ P712.03	Opening time	100 ms	0 ... 10000 ms	0x2820:003	general
↳ P712.07	Closing thresh.	0.2 Hz	0.0 ... 599.0 Hz	0x2820:007	general
↳ P712.08	Holding load	0.0 %	-500.0 ... 500.0 %	0x2820:008	general
↳ P712.12	ClosingThr delay	0 ms	0 ... 10000 ms	0x2820:012	general
↳ P712.13	HoldLoad ramptim	0 ms	0 ... 100 ms	0x2820:013	general
↳ P712.15	Brake status	-	-(Read only)	0x2820:015	general
P718.xx	Flying restart				
↳ P718.01	Current	30 %	0 ... 100 %	0x2BA1:001	MCTRL
↳ P718.02	Start frequency	20.0 Hz	-599.0 ... 599.0 Hz	0x2BA1:002	MCTRL
↳ P718.03	Restart time	5911 ms *	1 ... 60000 ms	0x2BA1:003	MCTRL
↳ P718.08	Fl.res.frequency	x.x Hz	-(Read only)	0x2BA1:008	MCTRL
P721.xx	Mains fail. ctrl				
↳ P721.01	Enable function	Disabled [0]	Selection list	0x2D66:001	general
↳ P721.02	DC-bus act.level	0 % *	60 ... 90 %	0x2D66:002	general
↳ P721.03	Gain V-ctrl	0.01000 Hz/V	0.00001 ... 0.50000 Hz/V	0x2D66:003	general
↳ P721.04	Res. time V-ctrl	20 ms	5 ... 2000 ms	0x2D66:004	general
↳ P721.05	DC voltage setp.	100 %	80 ... 110 %	0x2D66:005	general
↳ P721.06	Setp. ramp	20 ms	1 ... 16000 ms	0x2D66:006	general
↳ P721.07	Clear time	20 ms	1 ... 60000 ms	0x2D66:007	general
↳ P721.08	Restart level	0.0 Hz	0.0 ... 599.0 Hz	0x2D66:008	general
↳ P721.09	RERT:Status	-	-(Read only)	0x2D66:009	general
P730.00	PIN1 protection	0	-1 ... 9999	0x203D	general
P731.00	PIN2 protection	0	-1 ... 9999	0x203E	general
P732.00	Auto-Save EPM	Inhibit [0]	Selection list	0x2829	general
P740.xx	Favorites sett.				
↳ P740.01	Parameter 1	0x2DDD0000	0x00000000 ... 0xFFFFFFFF00	0x261C:001	general
↳ P740.02	Parameter 2	0x60780000	0x00000000 ... 0xFFFFFFFF00	0x261C:002	general
↳ P740.03	Parameter 3	0x2D890000	0x00000000 ... 0xFFFFFFFF00	0x261C:003	general
↳ P740.04	Parameter 4	0x603F0000	0x00000000 ... 0xFFFFFFFF00	0x261C:004	general
↳ P740.05	Parameter 5	0x28240000	0x00000000 ... 0xFFFFFFFF00	0x261C:005	general
↳ P740.06	Parameter 6	0x28600100	0x00000000 ... 0xFFFFFFFF00	0x261C:006	general
↳ P740.07	Parameter 7	0x28380100	0x00000000 ... 0xFFFFFFFF00	0x261C:007	general
↳ P740.08	Parameter 8	0x28380300	0x00000000 ... 0xFFFFFFFF00	0x261C:008	general
↳ P740.09	Parameter 9	0x25400100	0x00000000 ... 0xFFFFFFFF00	0x261C:009	general
↳ P740.10	Parameter 10	0x29150000	0x00000000 ... 0xFFFFFFFF00	0x261C:010	general
↳ P740.11	Parameter 11	0x29160000	0x00000000 ... 0xFFFFFFFF00	0x261C:011	general
↳ P740.12	Parameter 12	0x29170000	0x00000000 ... 0xFFFFFFFF00	0x261C:012	general
↳ P740.13	Parameter 13	0x29180000	0x00000000 ... 0xFFFFFFFF00	0x261C:013	general
↳ P740.14	Parameter 14	0x2C000000	0x00000000 ... 0xFFFFFFFF00	0x261C:014	general
↳ P740.15	Parameter 15	0x2B000000	0x00000000 ... 0xFFFFFFFF00	0x261C:015	general
↳ P740.16	Parameter 16	0x2B010100	0x00000000 ... 0xFFFFFFFF00	0x261C:016	general
↳ P740.17	Parameter 17	0x2B010200	0x00000000 ... 0xFFFFFFFF00	0x261C:017	general
↳ P740.18	Parameter 18	0x283A0000	0x00000000 ... 0xFFFFFFFF00	0x261C:018	general
↳ P740.19	Parameter 19	0x29390000	0x00000000 ... 0xFFFFFFFF00	0x261C:019	general
↳ P740.20	Parameter 20	0x2D4B0100	0x00000000 ... 0xFFFFFFFF00	0x261C:020	general
↳ P740.21	Parameter 21	0x2B120100	0x00000000 ... 0xFFFFFFFF00	0x261C:021	general
↳ P740.22	Parameter 22	0x60730000	0x00000000 ... 0xFFFFFFFF00	0x261C:022	general
↳ P740.23	Parameter 23	0x26310100	0x00000000 ... 0xFFFFFFFF00	0x261C:023	general
↳ P740.24	Parameter 24	0x26310200	0x00000000 ... 0xFFFFFFFF00	0x261C:024	general
↳ P740.25	Parameter 25	0x26310300	0x00000000 ... 0xFFFFFFFF00	0x261C:025	general

* Default setting depending on the size.

Firmware version 04.00.00.00

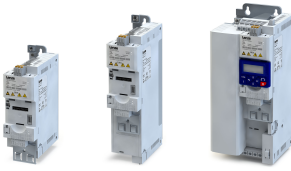

Commissioning

Keypad parameter list

Display code	Short designation	Default setting	Setting range	Address	Category
L P740.26	Parameter 26	0x26310400	0x00000000 ... 0xFFFFFFFF00	0x261C:026	general
L P740.27	Parameter 27	0x26310500	0x00000000 ... 0xFFFFFFFF00	0x261C:027	general
L P740.28	Parameter 28	0x26310600	0x00000000 ... 0xFFFFFFFF00	0x261C:028	general
L P740.29	Parameter 29	0x26310700	0x00000000 ... 0xFFFFFFFF00	0x261C:029	general
L P740.30	Parameter 30	0x26310800	0x00000000 ... 0xFFFFFFFF00	0x261C:030	general
L P740.31	Parameter 31	0x26310900	0x00000000 ... 0xFFFFFFFF00	0x261C:031	general
L P740.32	Parameter 32	0x26310D00	0x00000000 ... 0xFFFFFFFF00	0x261C:032	general
L P740.33	Parameter 33	0x26311200	0x00000000 ... 0xFFFFFFFF00	0x261C:033	general
L P740.34	Parameter 34	0x26311300	0x00000000 ... 0xFFFFFFFF00	0x261C:034	general
L P740.35	Parameter 35	0x26311400	0x00000000 ... 0xFFFFFFFF00	0x261C:035	general
L P740.36	Parameter 36	0x26340100	0x00000000 ... 0xFFFFFFFF00	0x261C:036	general
L P740.37	Parameter 37	0x26340200	0x00000000 ... 0xFFFFFFFF00	0x261C:037	general
L P740.38	Parameter 38	0x26360100	0x00000000 ... 0xFFFFFFFF00	0x261C:038	general
L P740.39	Parameter 39	0x26360200	0x00000000 ... 0xFFFFFFFF00	0x261C:039	general
L P740.40	Parameter 40	0x26360300	0x00000000 ... 0xFFFFFFFF00	0x261C:040	general
L P740.41	Parameter 41	0x26390100	0x00000000 ... 0xFFFFFFFF00	0x261C:041	general
L P740.42	Parameter 42	0x26390200	0x00000000 ... 0xFFFFFFFF00	0x261C:042	general
L P740.43	Parameter 43	0x26390300	0x00000000 ... 0xFFFFFFFF00	0x261C:043	general
L P740.44	Parameter 44	0x26390400	0x00000000 ... 0xFFFFFFFF00	0x261C:044	general
L P740.45	Parameter 45	0x29110100	0x00000000 ... 0xFFFFFFFF00	0x261C:045	general
L P740.46	Parameter 46	0x29110200	0x00000000 ... 0xFFFFFFFF00	0x261C:046	general
L P740.47	Parameter 47	0x29110300	0x00000000 ... 0xFFFFFFFF00	0x261C:047	general
L P740.48	Parameter 48	0x29110400	0x00000000 ... 0xFFFFFFFF00	0x261C:048	general
L P740.49	Parameter 49	0x00000000	0x00000000 ... 0xFFFFFFFF00	0x261C:049	general
L P740.50	Parameter 50	0x00000000	0x00000000 ... 0xFFFFFFFF00	0x261C:050	general
P750.xx	Param.set setup				
L P750.01	Parameter 1	0x00000000	0x00000000 ... 0xFFFFFFFF00	0x4041:001	general
L P750.02	Parameter 2	0x00000000	0x00000000 ... 0xFFFFFFFF00	0x4041:002	general
L P750.03	Parameter 3	0x00000000	0x00000000 ... 0xFFFFFFFF00	0x4041:003	general
L P750.04	Parameter 4	0x00000000	0x00000000 ... 0xFFFFFFFF00	0x4041:004	general
L P750.05	Parameter 5	0x00000000	0x00000000 ... 0xFFFFFFFF00	0x4041:005	general
L P750.06	Parameter 6	0x00000000	0x00000000 ... 0xFFFFFFFF00	0x4041:006	general
L P750.07	Parameter 7	0x00000000	0x00000000 ... 0xFFFFFFFF00	0x4041:007	general
L P750.08	Parameter 8	0x00000000	0x00000000 ... 0xFFFFFFFF00	0x4041:008	general
L P750.09	Parameter 9	0x00000000	0x00000000 ... 0xFFFFFFFF00	0x4041:009	general
L P750.10	Parameter 10	0x00000000	0x00000000 ... 0xFFFFFFFF00	0x4041:010	general
L P750.11	Parameter 11	0x00000000	0x00000000 ... 0xFFFFFFFF00	0x4041:011	general
L P750.12	Parameter 12	0x00000000	0x00000000 ... 0xFFFFFFFF00	0x4041:012	general
L P750.13	Parameter 13	0x00000000	0x00000000 ... 0xFFFFFFFF00	0x4041:013	general
L P750.14	Parameter 14	0x00000000	0x00000000 ... 0xFFFFFFFF00	0x4041:014	general
L P750.15	Parameter 15	0x00000000	0x00000000 ... 0xFFFFFFFF00	0x4041:015	general
L P750.16	Parameter 16	0x00000000	0x00000000 ... 0xFFFFFFFF00	0x4041:016	general
L P750.17	Parameter 17	0x00000000	0x00000000 ... 0xFFFFFFFF00	0x4041:017	general
L P750.18	Parameter 18	0x00000000	0x00000000 ... 0xFFFFFFFF00	0x4041:018	general
L P750.19	Parameter 19	0x00000000	0x00000000 ... 0xFFFFFFFF00	0x4041:019	general
L P750.20	Parameter 20	0x00000000	0x00000000 ... 0xFFFFFFFF00	0x4041:020	general
L P750.21	Parameter 21	0x00000000	0x00000000 ... 0xFFFFFFFF00	0x4041:021	general
L P750.22	Parameter 22	0x00000000	0x00000000 ... 0xFFFFFFFF00	0x4041:022	general
L P750.23	Parameter 23	0x00000000	0x00000000 ... 0xFFFFFFFF00	0x4041:023	general
L P750.24	Parameter 24	0x00000000	0x00000000 ... 0xFFFFFFFF00	0x4041:024	general
L P750.25	Parameter 25	0x00000000	0x00000000 ... 0xFFFFFFFF00	0x4041:025	general
L P750.26	Parameter 26	0x00000000	0x00000000 ... 0xFFFFFFFF00	0x4041:026	general
L P750.27	Parameter 27	0x00000000	0x00000000 ... 0xFFFFFFFF00	0x4041:027	general
L P750.28	Parameter 28	0x00000000	0x00000000 ... 0xFFFFFFFF00	0x4041:028	general

* Default setting depending on the size.

Firmware version 04.00.00.00

Commissioning

Keypad parameter list



Display code	Short designation	Default setting	Setting range	Address	Category
↳ P750.29	Parameter 29	0x00000000	0x00000000 ... 0xFFFFFFFF00	0x4041:029	general
↳ P750.30	Parameter 30	0x00000000	0x00000000 ... 0xFFFFFFFF00	0x4041:030	general
↳ P750.31	Parameter 31	0x00000000	0x00000000 ... 0xFFFFFFFF00	0x4041:031	general
↳ P750.32	Parameter 32	0x00000000	0x00000000 ... 0xFFFFFFFF00	0x4041:032	general
P751.xx	Par. value set 1				
↳ P751.01	Set 1 - Value 1	0	-2147483648 ... 2147483647	0x4042:001	general
↳ P751.02	Set 1 - Value 2	0	-2147483648 ... 2147483647	0x4042:002	general
↳ P751.03	Set 1 - Value 3	0	-2147483648 ... 2147483647	0x4042:003	general
↳ P751.04	Set 1 - Value 4	0	-2147483648 ... 2147483647	0x4042:004	general
↳ P751.05	Set 1 - Value 5	0	-2147483648 ... 2147483647	0x4042:005	general
↳ P751.06	Set 1 - Value 6	0	-2147483648 ... 2147483647	0x4042:006	general
↳ P751.07	Set 1 - Value 7	0	-2147483648 ... 2147483647	0x4042:007	general
↳ P751.08	Set 1 - Value 8	0	-2147483648 ... 2147483647	0x4042:008	general
↳ P751.09	Set 1 - Value 9	0	-2147483648 ... 2147483647	0x4042:009	general
↳ P751.10	Set 1 - Value 10	0	-2147483648 ... 2147483647	0x4042:010	general
↳ P751.11	Set 1 - Value 11	0	-2147483648 ... 2147483647	0x4042:011	general
↳ P751.12	Set 1 - Value 12	0	-2147483648 ... 2147483647	0x4042:012	general
↳ P751.13	Set 1 - Value 13	0	-2147483648 ... 2147483647	0x4042:013	general
↳ P751.14	Set 1 - Value 14	0	-2147483648 ... 2147483647	0x4042:014	general
↳ P751.15	Set 1 - Value 15	0	-2147483648 ... 2147483647	0x4042:015	general
↳ P751.16	Set 1 - Value 16	0	-2147483648 ... 2147483647	0x4042:016	general
↳ P751.17	Set 1 - Value 17	0	-2147483648 ... 2147483647	0x4042:017	general
↳ P751.18	Set 1 - Value 18	0	-2147483648 ... 2147483647	0x4042:018	general
↳ P751.19	Set 1 - Value 19	0	-2147483648 ... 2147483647	0x4042:019	general
↳ P751.20	Set 1 - Value 20	0	-2147483648 ... 2147483647	0x4042:020	general
↳ P751.21	Set 1 - Value 21	0	-2147483648 ... 2147483647	0x4042:021	general
↳ P751.22	Set 1 - Value 22	0	-2147483648 ... 2147483647	0x4042:022	general
↳ P751.23	Set 1 - Value 23	0	-2147483648 ... 2147483647	0x4042:023	general
↳ P751.24	Set 1 - Value 24	0	-2147483648 ... 2147483647	0x4042:024	general
↳ P751.25	Set 1 - Value 25	0	-2147483648 ... 2147483647	0x4042:025	general
↳ P751.26	Set 1 - Value 26	0	-2147483648 ... 2147483647	0x4042:026	general
↳ P751.27	Set 1 - Value 27	0	-2147483648 ... 2147483647	0x4042:027	general
↳ P751.28	Set 1 - Value 28	0	-2147483648 ... 2147483647	0x4042:028	general
↳ P751.29	Set 1 - Value 29	0	-2147483648 ... 2147483647	0x4042:029	general
↳ P751.30	Set 1 - Value 30	0	-2147483648 ... 2147483647	0x4042:030	general
↳ P751.31	Set 1 - Value 31	0	-2147483648 ... 2147483647	0x4042:031	general
↳ P751.32	Set 1 - Value 32	0	-2147483648 ... 2147483647	0x4042:032	general
P752.xx	Par. value set 2				
↳ P752.01	Set 2 - Value 1	0	-2147483648 ... 2147483647	0x4043:001	general
↳ P752.02	Set 2 - Value 2	0	-2147483648 ... 2147483647	0x4043:002	general
↳ P752.03	Set 2 - Value 3	0	-2147483648 ... 2147483647	0x4043:003	general
↳ P752.04	Set 2 - Value 4	0	-2147483648 ... 2147483647	0x4043:004	general
↳ P752.05	Set 2 - Value 5	0	-2147483648 ... 2147483647	0x4043:005	general
↳ P752.06	Set 2 - Value 6	0	-2147483648 ... 2147483647	0x4043:006	general
↳ P752.07	Set 2 - Value 7	0	-2147483648 ... 2147483647	0x4043:007	general
↳ P752.08	Set 2 - Value 8	0	-2147483648 ... 2147483647	0x4043:008	general
↳ P752.09	Set 2 - Value 9	0	-2147483648 ... 2147483647	0x4043:009	general
↳ P752.10	Set 2 - Value 10	0	-2147483648 ... 2147483647	0x4043:010	general
↳ P752.11	Set 2 - Value 11	0	-2147483648 ... 2147483647	0x4043:011	general
↳ P752.12	Set 2 - Value 12	0	-2147483648 ... 2147483647	0x4043:012	general
↳ P752.13	Set 2 - Value 13	0	-2147483648 ... 2147483647	0x4043:013	general
↳ P752.14	Set 2 - Value 14	0	-2147483648 ... 2147483647	0x4043:014	general
↳ P752.15	Set 2 - Value 15	0	-2147483648 ... 2147483647	0x4043:015	general
↳ P752.16	Set 2 - Value 16	0	-2147483648 ... 2147483647	0x4043:016	general

* Default setting depending on the size.

Firmware version 04.00.00.00



Commissioning

Keypad parameter list

Display code	Short designation	Default setting	Setting range	Address	Category
L P752.17	Set 2 - Value 17	0	-2147483648 ... 2147483647	0x4043:017	general
L P752.18	Set 2 - Value 18	0	-2147483648 ... 2147483647	0x4043:018	general
L P752.19	Set 2 - Value 19	0	-2147483648 ... 2147483647	0x4043:019	general
L P752.20	Set 2 - Value 20	0	-2147483648 ... 2147483647	0x4043:020	general
L P752.21	Set 2 - Value 21	0	-2147483648 ... 2147483647	0x4043:021	general
L P752.22	Set 2 - Value 22	0	-2147483648 ... 2147483647	0x4043:022	general
L P752.23	Set 2 - Value 23	0	-2147483648 ... 2147483647	0x4043:023	general
L P752.24	Set 2 - Value 24	0	-2147483648 ... 2147483647	0x4043:024	general
L P752.25	Set 2 - Value 25	0	-2147483648 ... 2147483647	0x4043:025	general
L P752.26	Set 2 - Value 26	0	-2147483648 ... 2147483647	0x4043:026	general
L P752.27	Set 2 - Value 27	0	-2147483648 ... 2147483647	0x4043:027	general
L P752.28	Set 2 - Value 28	0	-2147483648 ... 2147483647	0x4043:028	general
L P752.29	Set 2 - Value 29	0	-2147483648 ... 2147483647	0x4043:029	general
L P752.30	Set 2 - Value 30	0	-2147483648 ... 2147483647	0x4043:030	general
L P752.31	Set 2 - Value 31	0	-2147483648 ... 2147483647	0x4043:031	general
L P752.32	Set 2 - Value 32	0	-2147483648 ... 2147483647	0x4043:032	general
P753.xx	Par. value set 3				
L P753.01	Set 3 - Value 1	0	-2147483648 ... 2147483647	0x4044:001	general
L P753.02	Set 3 - Value 2	0	-2147483648 ... 2147483647	0x4044:002	general
L P753.03	Set 3 - Value 3	0	-2147483648 ... 2147483647	0x4044:003	general
L P753.04	Set 3 - Value 4	0	-2147483648 ... 2147483647	0x4044:004	general
L P753.05	Set 3 - Value 5	0	-2147483648 ... 2147483647	0x4044:005	general
L P753.06	Set 3 - Value 6	0	-2147483648 ... 2147483647	0x4044:006	general
L P753.07	Set 3 - Value 7	0	-2147483648 ... 2147483647	0x4044:007	general
L P753.08	Set 3 - Value 8	0	-2147483648 ... 2147483647	0x4044:008	general
L P753.09	Set 3 - Value 9	0	-2147483648 ... 2147483647	0x4044:009	general
L P753.10	Set 3 - Value 10	0	-2147483648 ... 2147483647	0x4044:010	general
L P753.11	Set 3 - Value 11	0	-2147483648 ... 2147483647	0x4044:011	general
L P753.12	Set 3 - Value 12	0	-2147483648 ... 2147483647	0x4044:012	general
L P753.13	Set 3 - Value 13	0	-2147483648 ... 2147483647	0x4044:013	general
L P753.14	Set 3 - Value 14	0	-2147483648 ... 2147483647	0x4044:014	general
L P753.15	Set 3 - Value 15	0	-2147483648 ... 2147483647	0x4044:015	general
L P753.16	Set 3 - Value 16	0	-2147483648 ... 2147483647	0x4044:016	general
L P753.17	Set 3 - Value 17	0	-2147483648 ... 2147483647	0x4044:017	general
L P753.18	Set 3 - Value 18	0	-2147483648 ... 2147483647	0x4044:018	general
L P753.19	Set 3 - Value 19	0	-2147483648 ... 2147483647	0x4044:019	general
L P753.20	Set 3 - Value 20	0	-2147483648 ... 2147483647	0x4044:020	general
L P753.21	Set 3 - Value 21	0	-2147483648 ... 2147483647	0x4044:021	general
L P753.22	Set 3 - Value 22	0	-2147483648 ... 2147483647	0x4044:022	general
L P753.23	Set 3 - Value 23	0	-2147483648 ... 2147483647	0x4044:023	general
L P753.24	Set 3 - Value 24	0	-2147483648 ... 2147483647	0x4044:024	general
L P753.25	Set 3 - Value 25	0	-2147483648 ... 2147483647	0x4044:025	general
L P753.26	Set 3 - Value 26	0	-2147483648 ... 2147483647	0x4044:026	general
L P753.27	Set 3 - Value 27	0	-2147483648 ... 2147483647	0x4044:027	general
L P753.28	Set 3 - Value 28	0	-2147483648 ... 2147483647	0x4044:028	general
L P753.29	Set 3 - Value 29	0	-2147483648 ... 2147483647	0x4044:029	general
L P753.30	Set 3 - Value 30	0	-2147483648 ... 2147483647	0x4044:030	general
L P753.31	Set 3 - Value 31	0	-2147483648 ... 2147483647	0x4044:031	general
L P753.32	Set 3 - Value 32	0	-2147483648 ... 2147483647	0x4044:032	general
P754.xx	Par. value set 4				
L P754.01	Set 4 - Value 1	0	-2147483648 ... 2147483647	0x4045:001	general
L P754.02	Set 4 - Value 2	0	-2147483648 ... 2147483647	0x4045:002	general
L P754.03	Set 4 - Value 3	0	-2147483648 ... 2147483647	0x4045:003	general
L P754.04	Set 4 - Value 4	0	-2147483648 ... 2147483647	0x4045:004	general

* Default setting depending on the size.

Firmware version 04.00.00.00

Commissioning

Keypad parameter list



Display code	Short designation	Default setting	Setting range	Address	Category
L P754.05	Set 4 - Value 5	0	-2147483648 ... 2147483647	0x4045:005	general
L P754.06	Set 4 - Value 6	0	-2147483648 ... 2147483647	0x4045:006	general
L P754.07	Set 4 - Value 7	0	-2147483648 ... 2147483647	0x4045:007	general
L P754.08	Set 4 - Value 8	0	-2147483648 ... 2147483647	0x4045:008	general
L P754.09	Set 4 - Value 9	0	-2147483648 ... 2147483647	0x4045:009	general
L P754.10	Set 4 - Value 10	0	-2147483648 ... 2147483647	0x4045:010	general
L P754.11	Set 4 - Value 11	0	-2147483648 ... 2147483647	0x4045:011	general
L P754.12	Set 4 - Value 12	0	-2147483648 ... 2147483647	0x4045:012	general
L P754.13	Set 4 - Value 13	0	-2147483648 ... 2147483647	0x4045:013	general
L P754.14	Set 4 - Value 14	0	-2147483648 ... 2147483647	0x4045:014	general
L P754.15	Set 4 - Value 15	0	-2147483648 ... 2147483647	0x4045:015	general
L P754.16	Set 4 - Value 16	0	-2147483648 ... 2147483647	0x4045:016	general
L P754.17	Set 4 - Value 17	0	-2147483648 ... 2147483647	0x4045:017	general
L P754.18	Set 4 - Value 18	0	-2147483648 ... 2147483647	0x4045:018	general
L P754.19	Set 4 - Value 19	0	-2147483648 ... 2147483647	0x4045:019	general
L P754.20	Set 4 - Value 20	0	-2147483648 ... 2147483647	0x4045:020	general
L P754.21	Set 4 - Value 21	0	-2147483648 ... 2147483647	0x4045:021	general
L P754.22	Set 4 - Value 22	0	-2147483648 ... 2147483647	0x4045:022	general
L P754.23	Set 4 - Value 23	0	-2147483648 ... 2147483647	0x4045:023	general
L P754.24	Set 4 - Value 24	0	-2147483648 ... 2147483647	0x4045:024	general
L P754.25	Set 4 - Value 25	0	-2147483648 ... 2147483647	0x4045:025	general
L P754.26	Set 4 - Value 26	0	-2147483648 ... 2147483647	0x4045:026	general
L P754.27	Set 4 - Value 27	0	-2147483648 ... 2147483647	0x4045:027	general
L P754.28	Set 4 - Value 28	0	-2147483648 ... 2147483647	0x4045:028	general
L P754.29	Set 4 - Value 29	0	-2147483648 ... 2147483647	0x4045:029	general
L P754.30	Set 4 - Value 30	0	-2147483648 ... 2147483647	0x4045:030	general
L P754.31	Set 4 - Value 31	0	-2147483648 ... 2147483647	0x4045:031	general
L P754.32	Set 4 - Value 32	0	-2147483648 ... 2147483647	0x4045:032	general
P755.00	PSet activation	On op. disabled [0]	Selection list	0x4046	general
P756.xx	PSet error msg.				
L P756.01	Status	-	-(Read only)	0x4047:001	general
L P756.02	List entry	-	-(Read only)	0x4047:002	general
P760.xx	Fault config.				
L P760.02	Restart delay	3.0 s	0.0 ... 1000.0 s	0x2839:002	general
L P760.03	Restart counter	5	0 ... 255	0x2839:003	general
L P760.04	Tro.count r.time	5.0 s	0.1 ... 3600.0 s	0x2839:004	general
L P760.05	Trouble counter	-	-(Read only)	0x2839:005	general
P780.00	CiA: Statusword	-	-(Read only)	0x6041	general
P781.00	Target velocity	0 rpm	-32768 ... 32767 rpm	0x6042	general
P782.00	Velocity demand	x rpm	-(Read only)	0x6043	general
P783.00	Velocity actual	x rpm	-(Read only)	0x6044	general
P784.xx	Vel. min max				
L P784.01	Vel. min amount	0 rpm	0 ... 480000 rpm	0x6046:001	general
L P784.02	Vel. max amount	2147483647 rpm	0 ... 2147483647 rpm	0x6046:002	general
P785.xx	Vel.acceleration				
L P785.01	Delta speed	3000 rpm	0 ... 2147483647 rpm	0x6048:001	general
L P785.02	Delta time	10 s	0 ... 65535 s	0x6048:002	general
P786.xx	Vel.deceleration				
L P786.01	Delta speed	3000 rpm	0 ... 2147483647 rpm	0x6049:001	general
L P786.02	Delta time	10 s	0 ... 65535 s	0x6049:002	general
P788.00	Modes of op. dis	-	-(Read only)	0x6061	general
P789.00	Supported modes	-	-(Read only)	0x6502	general
P790.00	Quick stop dec.	546000 pos. unit/s ²	0 ... 2147483647 pos. unit/s ²	0x6085	general
P791.00	Fault reaction	Coasting [0]	Selection list	0x605E	general

* Default setting depending on the size.

Firmware version 04.00.00.00

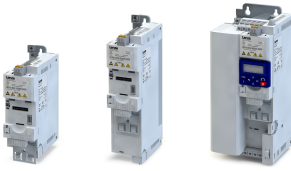

Commissioning

Keypad parameter list

Display code	Short designation	Default setting	Setting range	Address	Category
P800.00	Sequencer mode	Disabled [0]	Selection list	0x4025	general
P801.xx	Segment 1				
↳ P801.01	Frequency setp.	0.0 Hz	-599.0 ... 599.0 Hz	0x4026:001	general
↳ P801.02	Accel./decel.	5.0 s	0.0 ... 3600.0 s	0x4026:002	general
↳ P801.03	Time	0.0 s	0.0 ... 100000.0 s	0x4026:003	general
↳ P801.04	Digital outp.	0	0 ... 255	0x4026:004	general
↳ P801.05	Analog outp.	0.00 VDC	0.00 ... 10.00 VDC	0x4026:005	general
↳ P801.06	PID setp.	0.00 PID unit	-300.00 ... 300.00 PID unit	0x4026:006	general
↳ P801.07	Torque setp.	100.0 %	-400.0 ... 400.0 %	0x4026:007	general
P802.xx	Segment 2				
↳ P802.01	Frequency setp.	0.0 Hz	-599.0 ... 599.0 Hz	0x4027:001	general
↳ P802.02	Accel./decel.	5.0 s	0.0 ... 3600.0 s	0x4027:002	general
↳ P802.03	Time	0.0 s	0.0 ... 100000.0 s	0x4027:003	general
↳ P802.04	Digital outp.	0	0 ... 255	0x4027:004	general
↳ P802.05	Analog outp.	0.00 VDC	0.00 ... 10.00 VDC	0x4027:005	general
↳ P802.06	PID setp.	0.00 PID unit	-300.00 ... 300.00 PID unit	0x4027:006	general
↳ P802.07	Torque setp.	100.0 %	-400.0 ... 400.0 %	0x4027:007	general
P803.xx	Segment 3				
↳ P803.01	Frequency setp.	0.0 Hz	-599.0 ... 599.0 Hz	0x4028:001	general
↳ P803.02	Accel./decel.	5.0 s	0.0 ... 3600.0 s	0x4028:002	general
↳ P803.03	Time	0.0 s	0.0 ... 100000.0 s	0x4028:003	general
↳ P803.04	Digital outp.	0	0 ... 255	0x4028:004	general
↳ P803.05	Analog outp.	0.00 VDC	0.00 ... 10.00 VDC	0x4028:005	general
↳ P803.06	PID setp.	0.00 PID unit	-300.00 ... 300.00 PID unit	0x4028:006	general
↳ P803.07	Torque setp.	100.0 %	-400.0 ... 400.0 %	0x4028:007	general
P804.xx	Segment 4				
↳ P804.01	Frequency setp.	0.0 Hz	-599.0 ... 599.0 Hz	0x4029:001	general
↳ P804.02	Accel./decel.	5.0 s	0.0 ... 3600.0 s	0x4029:002	general
↳ P804.03	Time	0.0 s	0.0 ... 100000.0 s	0x4029:003	general
↳ P804.04	Digital outp.	0	0 ... 255	0x4029:004	general
↳ P804.05	Analog outp.	0.00 VDC	0.00 ... 10.00 VDC	0x4029:005	general
↳ P804.06	PID setp.	0.00 PID unit	-300.00 ... 300.00 PID unit	0x4029:006	general
↳ P804.07	Torque setp.	100.0 %	-400.0 ... 400.0 %	0x4029:007	general
P805.xx	Segment 5				
↳ P805.01	Frequency setp.	0.0 Hz	-599.0 ... 599.0 Hz	0x402A:001	general
↳ P805.02	Accel./decel.	5.0 s	0.0 ... 3600.0 s	0x402A:002	general
↳ P805.03	Time	0.0 s	0.0 ... 100000.0 s	0x402A:003	general
↳ P805.04	Digital outp.	0	0 ... 255	0x402A:004	general
↳ P805.05	Analog outp.	0.00 VDC	0.00 ... 10.00 VDC	0x402A:005	general
↳ P805.06	PID setp.	0.00 PID unit	-300.00 ... 300.00 PID unit	0x402A:006	general
↳ P805.07	Torque setp.	100.0 %	-400.0 ... 400.0 %	0x402A:007	general
P806.xx	Segment 6				
↳ P806.01	Frequency setp.	0.0 Hz	-599.0 ... 599.0 Hz	0x402B:001	general
↳ P806.02	Accel./decel.	5.0 s	0.0 ... 3600.0 s	0x402B:002	general
↳ P806.03	Time	0.0 s	0.0 ... 100000.0 s	0x402B:003	general
↳ P806.04	Digital outp.	0	0 ... 255	0x402B:004	general
↳ P806.05	Analog outp.	0.00 VDC	0.00 ... 10.00 VDC	0x402B:005	general
↳ P806.06	PID setp.	0.00 PID unit	-300.00 ... 300.00 PID unit	0x402B:006	general
↳ P806.07	Torque setp.	100.0 %	-400.0 ... 400.0 %	0x402B:007	general
P807.xx	Segment 7				
↳ P807.01	Frequency setp.	0.0 Hz	-599.0 ... 599.0 Hz	0x402C:001	general
↳ P807.02	Accel./decel.	5.0 s	0.0 ... 3600.0 s	0x402C:002	general
↳ P807.03	Time	0.0 s	0.0 ... 100000.0 s	0x402C:003	general
↳ P807.04	Digital outp.	0	0 ... 255	0x402C:004	general

* Default setting depending on the size.

Firmware version 04.00.00.00

Commissioning

Keypad parameter list



Display code	Short designation	Default setting	Setting range	Address	Category
↳ P807.05	Analog outp.	0.00 VDC	0.00 ... 10.00 VDC	0x402C:005	general
↳ P807.06	PID setp.	0.00 PID unit	-300.00 ... 300.00 PID unit	0x402C:006	general
↳ P807.07	Torque setp.	100.0 %	-400.0 ... 400.0 %	0x402C:007	general
P808.xx	Segment 8				
↳ P808.01	Frequency setp.	0.0 Hz	-599.0 ... 599.0 Hz	0x402D:001	general
↳ P808.02	Accel./decel.	5.0 s	0.0 ... 3600.0 s	0x402D:002	general
↳ P808.03	Time	0.0 s	0.0 ... 100000.0 s	0x402D:003	general
↳ P808.04	Digital outp.	0	0 ... 255	0x402D:004	general
↳ P808.05	Analog outp.	0.00 VDC	0.00 ... 10.00 VDC	0x402D:005	general
↳ P808.06	PID setp.	0.00 PID unit	-300.00 ... 300.00 PID unit	0x402D:006	general
↳ P808.07	Torque setp.	100.0 %	-400.0 ... 400.0 %	0x402D:007	general
P820.00	StartOfSeq. mode	Restart sequencr [0]	Selection list	0x4040	general
P822.xx	End segment				
↳ P822.01	Frequency setp.	0.0 Hz	-599.0 ... 599.0 Hz	0x402E:001	general
↳ P822.02	Accel./decel.	5.0 s	0.0 ... 3600.0 s	0x402E:002	general
↳ P822.03	Time	0.0 s	0.0 ... 100000.0 s	0x402E:003	general
↳ P822.04	Digital outp.	0	0 ... 255	0x402E:004	general
↳ P822.05	Analog outp.	0.00 VDC	0.00 ... 10.00 VDC	0x402E:005	general
↳ P822.06	PID setp.	0.00 PID unit	-300.00 ... 300.00 PID unit	0x402E:006	general
↳ P822.07	Torque setp.	100.0 %	-400.0 ... 400.0 %	0x402E:007	general
P824.00	End of seq. mode	Keep running [0]	Selection list	0x402F	general
P830.xx	Sequence 1				
↳ P830.01	Step 1	Skip step [0]	Selection list	0x4030:001	general
↳ P830.02	Step 2	Skip step [0]	Selection list	0x4030:002	general
↳ P830.03	Step 3	Skip step [0]	Selection list	0x4030:003	general
↳ P830.04	Step 4	Skip step [0]	Selection list	0x4030:004	general
↳ P830.05	Step 5	Skip step [0]	Selection list	0x4030:005	general
↳ P830.06	Step 6	Skip step [0]	Selection list	0x4030:006	general
↳ P830.07	Step 7	Skip step [0]	Selection list	0x4030:007	general
↳ P830.08	Step 8	Skip step [0]	Selection list	0x4030:008	general
↳ P830.09	Step 9	Skip step [0]	Selection list	0x4030:009	general
↳ P830.10	Step 10	Skip step [0]	Selection list	0x4030:010	general
↳ P830.11	Step 11	Skip step [0]	Selection list	0x4030:011	general
↳ P830.12	Step 12	Skip step [0]	Selection list	0x4030:012	general
↳ P830.13	Step 13	Skip step [0]	Selection list	0x4030:013	general
↳ P830.14	Step 14	Skip step [0]	Selection list	0x4030:014	general
↳ P830.15	Step 15	Skip step [0]	Selection list	0x4030:015	general
↳ P830.16	Step 16	Skip step [0]	Selection list	0x4030:016	general
P831.00	Cycl. sequence 1	1	1 ... 65535	0x4031	general
P835.xx	Sequence 2				
↳ P835.01	Step 1	Skip step [0]	Selection list	0x4032:001	general
↳ P835.02	Step 2	Skip step [0]	Selection list	0x4032:002	general
↳ P835.03	Step 3	Skip step [0]	Selection list	0x4032:003	general
↳ P835.04	Step 4	Skip step [0]	Selection list	0x4032:004	general
↳ P835.05	Step 5	Skip step [0]	Selection list	0x4032:005	general
↳ P835.06	Step 6	Skip step [0]	Selection list	0x4032:006	general
↳ P835.07	Step 7	Skip step [0]	Selection list	0x4032:007	general
↳ P835.08	Step 8	Skip step [0]	Selection list	0x4032:008	general
↳ P835.09	Step 9	Skip step [0]	Selection list	0x4032:009	general
↳ P835.10	Step 10	Skip step [0]	Selection list	0x4032:010	general
↳ P835.11	Step 11	Skip step [0]	Selection list	0x4032:011	general
↳ P835.12	Step 12	Skip step [0]	Selection list	0x4032:012	general
↳ P835.13	Step 13	Skip step [0]	Selection list	0x4032:013	general
↳ P835.14	Step 14	Skip step [0]	Selection list	0x4032:014	general

* Default setting depending on the size.

Firmware version 04.00.00.00

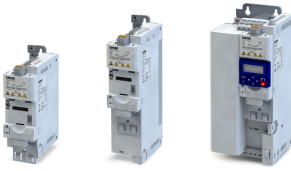

Commissioning

Keypad parameter list

Display code	Short designation	Default setting	Setting range	Address	Category
↳ P835.15	Step 15	Skip step [0]	Selection list	0x4032:015	general
↳ P835.16	Step 16	Skip step [0]	Selection list	0x4032:016	general
P836.00	Cycl. sequence 2	1	1 ... 65535	0x4033	general
P840.xx	Sequence 3				
↳ P840.01	Step 1	Skip step [0]	Selection list	0x4034:001	general
↳ P840.02	Step 2	Skip step [0]	Selection list	0x4034:002	general
↳ P840.03	Step 3	Skip step [0]	Selection list	0x4034:003	general
↳ P840.04	Step 4	Skip step [0]	Selection list	0x4034:004	general
↳ P840.05	Step 5	Skip step [0]	Selection list	0x4034:005	general
↳ P840.06	Step 6	Skip step [0]	Selection list	0x4034:006	general
↳ P840.07	Step 7	Skip step [0]	Selection list	0x4034:007	general
↳ P840.08	Step 8	Skip step [0]	Selection list	0x4034:008	general
↳ P840.09	Step 9	Skip step [0]	Selection list	0x4034:009	general
↳ P840.10	Step 10	Skip step [0]	Selection list	0x4034:010	general
↳ P840.11	Step 11	Skip step [0]	Selection list	0x4034:011	general
↳ P840.12	Step 12	Skip step [0]	Selection list	0x4034:012	general
↳ P840.13	Step 13	Skip step [0]	Selection list	0x4034:013	general
↳ P840.14	Step 14	Skip step [0]	Selection list	0x4034:014	general
↳ P840.15	Step 15	Skip step [0]	Selection list	0x4034:015	general
↳ P840.16	Step 16	Skip step [0]	Selection list	0x4034:016	general
P841.00	Cycl. sequence 3	1	1 ... 65535	0x4035	general
P845.xx	Sequence 4				
↳ P845.01	Step 1	Skip step [0]	Selection list	0x4036:001	general
↳ P845.02	Step 2	Skip step [0]	Selection list	0x4036:002	general
↳ P845.03	Step 3	Skip step [0]	Selection list	0x4036:003	general
↳ P845.04	Step 4	Skip step [0]	Selection list	0x4036:004	general
↳ P845.05	Step 5	Skip step [0]	Selection list	0x4036:005	general
↳ P845.06	Step 6	Skip step [0]	Selection list	0x4036:006	general
↳ P845.07	Step 7	Skip step [0]	Selection list	0x4036:007	general
↳ P845.08	Step 8	Skip step [0]	Selection list	0x4036:008	general
↳ P845.09	Step 9	Skip step [0]	Selection list	0x4036:009	general
↳ P845.10	Step 10	Skip step [0]	Selection list	0x4036:010	general
↳ P845.11	Step 11	Skip step [0]	Selection list	0x4036:011	general
↳ P845.12	Step 12	Skip step [0]	Selection list	0x4036:012	general
↳ P845.13	Step 13	Skip step [0]	Selection list	0x4036:013	general
↳ P845.14	Step 14	Skip step [0]	Selection list	0x4036:014	general
↳ P845.15	Step 15	Skip step [0]	Selection list	0x4036:015	general
↳ P845.16	Step 16	Skip step [0]	Selection list	0x4036:016	general
P846.00	Cycl. sequence 4	1	1 ... 65535	0x4037	general
P850.xx	Sequence 5				
↳ P850.01	Step 1	Skip step [0]	Selection list	0x4038:001	general
↳ P850.02	Step 2	Skip step [0]	Selection list	0x4038:002	general
↳ P850.03	Step 3	Skip step [0]	Selection list	0x4038:003	general
↳ P850.04	Step 4	Skip step [0]	Selection list	0x4038:004	general
↳ P850.05	Step 5	Skip step [0]	Selection list	0x4038:005	general
↳ P850.06	Step 6	Skip step [0]	Selection list	0x4038:006	general
↳ P850.07	Step 7	Skip step [0]	Selection list	0x4038:007	general
↳ P850.08	Step 8	Skip step [0]	Selection list	0x4038:008	general
↳ P850.09	Step 9	Skip step [0]	Selection list	0x4038:009	general
↳ P850.10	Step 10	Skip step [0]	Selection list	0x4038:010	general
↳ P850.11	Step 11	Skip step [0]	Selection list	0x4038:011	general
↳ P850.12	Step 12	Skip step [0]	Selection list	0x4038:012	general
↳ P850.13	Step 13	Skip step [0]	Selection list	0x4038:013	general
↳ P850.14	Step 14	Skip step [0]	Selection list	0x4038:014	general

* Default setting depending on the size.

Firmware version 04.00.00.00

Commissioning

Keypad parameter list



Display code	Short designation	Default setting	Setting range	Address	Category
↳ P850.15	Step 15	Skip step [0]	Selection list	0x4038:015	general
↳ P850.16	Step 16	Skip step [0]	Selection list	0x4038:016	general
P851.00	Cycl. sequence 5	1	1 ... 65535	0x4039	general
P855.xx	Sequence 6				
↳ P855.01	Step 1	Skip step [0]	Selection list	0x403A:001	general
↳ P855.02	Step 2	Skip step [0]	Selection list	0x403A:002	general
↳ P855.03	Step 3	Skip step [0]	Selection list	0x403A:003	general
↳ P855.04	Step 4	Skip step [0]	Selection list	0x403A:004	general
↳ P855.05	Step 5	Skip step [0]	Selection list	0x403A:005	general
↳ P855.06	Step 6	Skip step [0]	Selection list	0x403A:006	general
↳ P855.07	Step 7	Skip step [0]	Selection list	0x403A:007	general
↳ P855.08	Step 8	Skip step [0]	Selection list	0x403A:008	general
↳ P855.09	Step 9	Skip step [0]	Selection list	0x403A:009	general
↳ P855.10	Step 10	Skip step [0]	Selection list	0x403A:010	general
↳ P855.11	Step 11	Skip step [0]	Selection list	0x403A:011	general
↳ P855.12	Step 12	Skip step [0]	Selection list	0x403A:012	general
↳ P855.13	Step 13	Skip step [0]	Selection list	0x403A:013	general
↳ P855.14	Step 14	Skip step [0]	Selection list	0x403A:014	general
↳ P855.15	Step 15	Skip step [0]	Selection list	0x403A:015	general
↳ P855.16	Step 16	Skip step [0]	Selection list	0x403A:016	general
P856.00	Cycl. sequence 6	1	1 ... 65535	0x403B	general
P860.xx	Sequence 7				
↳ P860.01	Step 1	Skip step [0]	Selection list	0x403C:001	general
↳ P860.02	Step 2	Skip step [0]	Selection list	0x403C:002	general
↳ P860.03	Step 3	Skip step [0]	Selection list	0x403C:003	general
↳ P860.04	Step 4	Skip step [0]	Selection list	0x403C:004	general
↳ P860.05	Step 5	Skip step [0]	Selection list	0x403C:005	general
↳ P860.06	Step 6	Skip step [0]	Selection list	0x403C:006	general
↳ P860.07	Step 7	Skip step [0]	Selection list	0x403C:007	general
↳ P860.08	Step 8	Skip step [0]	Selection list	0x403C:008	general
↳ P860.09	Step 9	Skip step [0]	Selection list	0x403C:009	general
↳ P860.10	Step 10	Skip step [0]	Selection list	0x403C:010	general
↳ P860.11	Step 11	Skip step [0]	Selection list	0x403C:011	general
↳ P860.12	Step 12	Skip step [0]	Selection list	0x403C:012	general
↳ P860.13	Step 13	Skip step [0]	Selection list	0x403C:013	general
↳ P860.14	Step 14	Skip step [0]	Selection list	0x403C:014	general
↳ P860.15	Step 15	Skip step [0]	Selection list	0x403C:015	general
↳ P860.16	Step 16	Skip step [0]	Selection list	0x403C:016	general
P861.00	Cycl. sequence 7	1	1 ... 65535	0x403D	general
P865.xx	Sequence 8				
↳ P865.01	Step 1	Skip step [0]	Selection list	0x403E:001	general
↳ P865.02	Step 2	Skip step [0]	Selection list	0x403E:002	general
↳ P865.03	Step 3	Skip step [0]	Selection list	0x403E:003	general
↳ P865.04	Step 4	Skip step [0]	Selection list	0x403E:004	general
↳ P865.05	Step 5	Skip step [0]	Selection list	0x403E:005	general
↳ P865.06	Step 6	Skip step [0]	Selection list	0x403E:006	general
↳ P865.07	Step 7	Skip step [0]	Selection list	0x403E:007	general
↳ P865.08	Step 8	Skip step [0]	Selection list	0x403E:008	general
↳ P865.09	Step 9	Skip step [0]	Selection list	0x403E:009	general
↳ P865.10	Step 10	Skip step [0]	Selection list	0x403E:010	general
↳ P865.11	Step 11	Skip step [0]	Selection list	0x403E:011	general
↳ P865.12	Step 12	Skip step [0]	Selection list	0x403E:012	general
↳ P865.13	Step 13	Skip step [0]	Selection list	0x403E:013	general
↳ P865.14	Step 14	Skip step [0]	Selection list	0x403E:014	general

* Default setting depending on the size.

Firmware version 04.00.00.00



Display code	Short designation	Default setting	Setting range	Address	Category
L P865.15	Step 15	Skip step [0]	Selection list	0x403E:015	general
L P865.16	Step 16	Skip step [0]	Selection list	0x403E:016	general
P866.00	Cycl. sequence 8	1	1 ... 65535	0x403F	general

* Default setting depending on the size. Firmware version 04.00.00.00

4.5 Save parameter settings in the memory module

4.5.1 Save parameter settings with keypad

If one parameter setting has been changed with the keypad but has not been saved in the memory module with mains failure protection, the SET display is blinking.

In order to save parameter settings in the user memory of the memory module, press the keypad enter key longer than 3 s.



4.5.2 Save parameter settings with »EASY Starter«

If a parameter setting has been changed with the »EASY Starter« but not yet saved in the memory module with mains failure protection, the status line of the »EASY Starter« displays the note "The parameter set was changed".

In order to save parameter settings in the user memory of the memory module,





















- click the button in the toolbar of the »EASY Starter«  or
- press the function key <F6> or
- execute the device command "Save user data": 0x2022:003 (P700.03) = "On / start [1]".



5 Diagnostics and fault elimination

5.1 LED status display

The "RDY" and "ERR" LED status displays on the front of the inverter provide some quick information about certain operating states.

"RDY" LED (blue)	"ERR" LED (red)	Status/meaning
off	off	No supply voltage.
 on	 on	Initialisation (inverter is started.)
 blinking (1 Hz)	off	Safe torque off (STO) active. ▶ Safe torque off (STO)  492
	 blinking fast (4 Hz)	Safe torque off (STO) active, warning active.
 blinking (2 Hz)	off	Inverter inhibited.
	 blinking fast (4 Hz)	Inverter disabled, warning active. ▶ Error handling  113
	 on	Inverter disabled, error active. ▶ Error handling  113
	 lit every 1.5 s for a short time	Inverter inhibited, no DC-bus voltage.
	 on for a short time every 1 s	USB module is connected, 5-V supply voltage for the USB module is available.
 on	off	Inverter enabled. The motor rotates according to the specified setpoint or quick stop active.
	 blinking fast (4 Hz)	Inverter enabled, warning active. The motor rotates according to the specified setpoint or quick stop active.
	 blinking (1 Hz)	Inverter enabled, quick stop as response to fault active. ▶ Error handling  113
 Both LEDs are blinking in a rapidly alternating mode		Firmware update active. ▶ Firmware download  455
 Both LEDs are blinking in a very rapidly synchronous mode		"Visual tracking" function is active. ▶ Optical device identification  135



5.2 Diagnostics parameter

The inverter provides many diagnostic parameters which are helpful for operation, maintenance, error diagnosis, error correction, etc.

- In the following overview the most common diagnostic parameters are listed. For the keypad you can find these diagnostic parameters in group 1.
- Further parameters for more specific diagnostic purposes are described in the following subchapters.
- The diagnostic parameters can only be read and cannot be written to.

Parameter	Name / value range / [default setting]	Info
0x2030	CRC parameter set • Read only	Display of the 32-bit hash sum for the integrity check of the parameter set.
0x2B0B	Frequency setpoint • Read only: x.x Hz • From version 03.00	Display of the actual frequency setpoint that is internally transferred to the motor control (after scaling and ramp generator).
0x2B0E (P102.00)	Frequency setpoint (Freq. setpoint) • Read only: x.x Hz	Display of the frequency setpoint currently assigned. • Depending on the present operating conditions, this value may differ from the current output frequency 0x2DDD (P100.00) .
0x2B0F	VFC output frequency • Read only: x.x Hz	Display of the current output frequency at V/f operation.
0x2D4F (P123.00)	Motor utilisation ($i^2 \cdot t$) (Mot. i2t utilis.) • Read only: x %	Display of the current thermal motor utilisation.
0x2D87 (P105.00)	DC-bus voltage (DC-bus voltage) • Read only: x V	Display of the current DC-bus voltage.
0x2D88 (P104.00)	Motor current (Motor current) • Read only: x.x A	Display des present current-r.m.s. value.
0x2D89 (P106.00)	Motor voltage (Motor voltage) • Read only: x VAC	Display of the current motor voltage.
0x2DA2:001 (P108.01)	Output power: Effective power (Output power: Effective power) • Read only: x.xxx kW	Display of the active output power for an energy analysis in the respective application.
0x2DA2:002 (P108.02)	Output power: Apparent power (Output power: Apparent power) • Read only: x.xxx kVA	Display of the apparent output power for an energy analysis in the respective application.
0x2DA3:001 (P109.01)	Output energy: Motor (Output energy: Motor) • Read only: x.xx kWh	Display of the output power in motor mode for an energy analysis in the respective application.
0x2DA3:002 (P109.02)	Output energy: Generator (Output energy: Generator) • Read only: x.xx kWh	Display of the output power in generator mode for an energy analysis in the respective application.
0x2DDD (P100.00)	Output frequency (Output frequency) • Read only: x.x Hz	Display of the current output frequency for diagnostics of the control.
0x400D (P101.00)	Scaled actual value (Scaled act value) • Read only: x Units	Display of the current speed in application units.
0x6077 (P107.00)	Torque actual value (Torque actual) • Read only: x.x %	Display of the current torque. • 100 % \equiv Motor rated torque 0x6076 (P325.00)
0x6078 (P103.00)	Current actual value (Current actual) • Read only: x.x %	Display of the present motor current. • 100 % \equiv Motor rated current 0x6075 (P323.00)

Diagnostics and fault elimination

Diagnostics parameter
Logbook



5.2.1 Logbook

For diagnostic purposes, the logbook contains the last 32 error messages and warning signals of the inverter, which have occurred during operation.

Preconditions

The logbook can only be accessed

- via the user interface of »EASY Starter« ("Diagnostics" tab) or
- via network.

Details

In contrast to the error history buffer, the logbook additionally protocols the following events:

- Fault messages
- Change-over from normal to setup mode (and vice versa)
- Execution of device commands
- Avoidance of safety functions

The logbook entries are saved persistently in the inverter. If all 32 memory units are occupied, the oldest entry is deleted for a new entry. By means of the "Delete logbook" device command, all logbook entries can be deleted.

Accessing the logbook with »EASY Starter«

1. Select the inverter on the left side in the »EASY Starter« device list.
2. Change to the "Diagnostics" tab.
3. Click the  icon to open the logbook.

Observe that the logbook only presents a snapshot at the time the data are read out. If a new event occurs, the logbook must be read out again so that the new event becomes visible.

Accessing the logbook via network

The logbook can also be accessed via network from a higher-level controller or a visualisation. The structure of the diagnostic messages complies with the "ETG.1020" standard of the EtherCAT Technology Group (ETG).



See chapter 13.3 of document "ETG.1020 Protocol Enhancements" provided by the EtherCAT Technology Group (ETG) for detailed information on the structure of the diagnostic messages.

Parameter	Name / value range / [default setting]	Info	
0x2022:015 (P700.15)	Device commands: Delete logbook (Device commands: Delete logbook) <ul style="list-style-type: none">• Setting can only be changed if the inverter is inhibited.	1 = delete all entries in the logbook.	
	0 Off / ready		
	1 On / start		

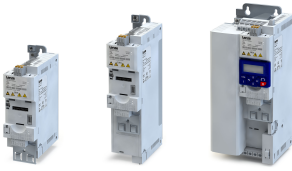

5.2.2 Error history buffer

For purposes of diagnostics, the error history buffer contains the last 32 error and warning messages of the inverter, which have occurred during operation. The error history buffer can be read out using the keypad via P155.00 and provides a limited view on the logbook.

Details

- For each event that is recorded, the error history buffer contains the message text, the error code, the time of occurrence as well as a counter for successive, identical events. If an event that has already been recorded occurs repeatedly, only the counter is incremented.
- The error history buffer can be reset by the user. In order to prevent the buffer from being reset by the user, this function can be protected by means of a password.
- Observe that the error history buffer only presents a snapshot at the time the data are read out. If a new event occurs, the error history buffer must be read out again via P155.00 so that the new event becomes visible.

Accessing the error history buffer with the keypad

1. 1. VEL:FLEX#AIN1
STOP
REM AUTO SET-I
2. 2. Favorites
GROUP 0
REM AUTO SET-I
3. 3. Diagnostics
GROUP 1
REM AUTO SET-I
4. 4. Output frequency
P10000
REM AUTO SET-I
5. 5. Error memory
P15500
REM AUTO SET-I
6. 6. Warn. DC Bus UV
01 W 322 1
REM AUTO SET-I
7. 7. Time:01d17h04m00s
01 C + 001
REM AUTO SET-I

1. Use the key in the operating mode to navigate to the parameterisation mode one level below.
You are now in the group level. All parameters of the inverter are divided into different groups according to their function.
Note: By using the key you can navigate one level upwards again anytime.
2. Use the navigation key to select group 1 ("Diagnostics").
3. Use the key to navigate to one level below.
You are now in the parameter level of the group selected.
4. Use the and select the P155.00 parameter.
5. Use the key to navigate to one level below.
You are now in the error history buffer.
6. Use the and navigation keys you can now scroll through the error history buffer entries.
Use the key, you can switch over the display.

Information displayed (page 1):

- ① Message text
- ② No. of the entry (01 = latest event)
- ③ Response (W = warning, T = trouble, F = fault)
- ④ Error code

Information displayed (page 2):

- ⑤ Time of occurrence
- ⑥ No. of the entry (01 = latest event)
- ⑦ Counter for successive, identical events

Note: By using the key you can exit the error history buffer again.

Parameter	Name / value range / [default setting]	Info
0x2006:000 (P155.00)	Error history buffer: Keypad display (Fault memory: Error memory) • Read only	Display of the error history buffer on the keypad.
0x2006:001	Error history buffer: Maximum number of messages • Read only	Display of the maximum number of messages which can be stored in the history buffer (from subindex 6).

Diagnostics and fault elimination

Diagnostics parameter
Error history buffer



Parameter	Name / value range / [default setting]	Info	
0x2006:002	Error history buffer: Latest message • Read only	Display of the subindex of the most recent message.	
0x2006:003	Error history buffer: Latest acknowledgement message 0 ... [0] ... 37	0 = delete all entries in the error history buffer.	
0x2006:004	Error history buffer: New message • Read only	Reserved for future extensions.	
0x2006:005	Error history buffer: Buffer overflow 0 ... [1] ... 65535	Bit 0 ... bit 4 = 0. Bit 5 = 1 ≡ overflow (after recording the 33rd event in the error history buffer).	
	Bit 0		Send emergency message
	Bit 1		Disable info message
	Bit 2		Disable warning message
	Bit 3		Disable error message
	Bit 4		Mode selection
0x2006:006	Error history buffer: Message 0 • Read only	Error history buffer entry 01 (latest event)	
0x2006:007	Error history buffer: Message 1 • Read only	Error history buffer entry 02	
0x2006:008	Error history buffer: Message 2 • Read only	Error history buffer entry 03	
0x2006:009	Error history buffer: Message 3 • Read only	Error history buffer entry 04	
0x2006:010	Error history buffer: Message 4 • Read only	Error history buffer entry 05	
0x2006:011	Error history buffer: Message 5 • Read only	Error history buffer entry 06	
0x2006:012	Error history buffer: Message 6 • Read only	Error history buffer entry 07	
0x2006:013	Error history buffer: Message 7 • Read only	Error history buffer entry 08	
0x2006:014	Error history buffer: Message 8 • Read only	Error history buffer entry 09	
0x2006:015	Error history buffer: Message 9 • Read only	Error history buffer entry 10	
0x2006:016	Error history buffer: Message 10 • Read only	Error history buffer entry 11	
0x2006:017	Error history buffer: Message 11 • Read only	Error history buffer entry 12	
0x2006:018	Error history buffer: Message 12 • Read only	Error history buffer entry 13	
0x2006:019	Error history buffer: Message 13 • Read only	Error history buffer entry 14	
0x2006:020	Error history buffer: Message 14 • Read only	Error history buffer entry 15	
0x2006:021	Error history buffer: Message 15 • Read only	Error history buffer entry 16	
0x2006:022	Error history buffer: Message 16 • Read only	Error history buffer entry 17	
0x2006:023	Error history buffer: Message 17 • Read only	Error history buffer entry 18	
0x2006:024	Error history buffer: Message 18 • Read only	Error history buffer entry 19	
0x2006:025	Error history buffer: Message 19 • Read only	Error history buffer entry 20	
0x2006:026	Error history buffer: Message 20 • Read only	Error history buffer entry 21	
0x2006:027	Error history buffer: Message 21 • Read only	Error history buffer entry 22	



Diagnostics and fault elimination

Diagnostics parameter
Error history buffer

Parameter	Name / value range / [default setting]	Info
0x2006:028	Error history buffer: Message 22 • Read only	Error history buffer entry 23
0x2006:029	Error history buffer: Message 23 • Read only	Error history buffer entry 24
0x2006:030	Error history buffer: Message 24 • Read only	Error history buffer entry 25
0x2006:031	Error history buffer: Message 25 • Read only	Error history buffer entry 26
0x2006:032	Error history buffer: Message 26 • Read only	Error history buffer entry 27
0x2006:033	Error history buffer: Message 27 • Read only	Error history buffer entry 28
0x2006:034	Error history buffer: Message 28 • Read only	Error history buffer entry 29
0x2006:035	Error history buffer: Message 29 • Read only	Error history buffer entry 30
0x2006:036	Error history buffer: Message 30 • Read only	Error history buffer entry 31
0x2006:037	Error history buffer: Message 31 • Read only	Error history buffer entry 32

Structure of the messages

The following example shows the detailed structure of one of the following messages (parameter 0x2006:006 ... 0x2006:037):

Message:	00E010431201990000520B0473FC0100050001					
	00E01043	1201	9900	00520B0473FC0100	0500	01
Meaning:	Diag code	Message type	Text ID	Time stamp in [ns]	Flag param. 1	Parameter 1
Data type:	U32	U16	U16	U64	U16	U8
Hex value:	0x4310 E000	0x0112	0x0099	0x0001 FC73 040B 5200	0x0005	0x01

Notes:

- The upper 16 bits of the "Diag Code" contain the error code (in the example "0x4310").
- Bit 0 ... 3 of the message type contain the error type (0: Info, 1: Warning, 2: Trouble, 3: Fault).
- Convert time stamp: 0x0001 FC73 040B 5200 = 559045896000000 ns = 6 days, 11 hours, 17 minutes, 25 seconds
- The flag for parameter 1 has no meaning for decoding the message.
- The parameter 1 contains the counter for successive, identical events.

Diagnostics and fault elimination

Diagnostics parameter
Inverter diagnostics



5.2.3 Inverter diagnostics

The following parameters supply some information about the current operating status of the inverter.

This includes the following information:

- Active access protection after log-in by means of PIN1/PIN2
- Currently loaded parameter settings
- Cause(s) for disable, quick stop and stop.
- Active control source and active setpoint source
- Active operating mode
- Keypad status
- Status of the internal motor control

Some of the following parameters contain bit-coded status words. Each single bit has a certain meaning.

▶ [Display of status words on keypad](#) 606

Parameter	Name / value range / [default setting]	Info	
0x2040 (P197.00)	Access protection status (Protect. status)	Bit-coded display of the active access protection after login by PIN1/ PIN2.	
	• Read only		
	Bit 0 No write access		
	Bit 1 Only favorites changeable		
0x2827 (P198.00)	Currently loaded parameter settings (Status load. par)	Display of the parameter settings currently loaded. ▶ Data handling 115 ▶ Saving/loading the parameter settings 367	
	• Read only		
	0 User settings		User parameter settings of the memory module
	1 Reset 60 Hz setting		Delivery status (default setting) for 50-Hz device
	2 Reset 50 Hz setting		Delivery status (default setting) for 60-Hz device
3 OEM default settings	OEM parameter settings of the memory module		
0x282A:001 (P126.01)	Status words: Cause of disable (Status words: Cause of disable)	Bit-coded display of the cause(s) for disabled inverter.	
	• Read only		
	Bit 0 Flexible I/O configuration		1 ≙ the inverter was disabled by the trigger set in 0x2631:001 (P400.01) .
	Bit 1 Network		1 ≙ the inverter was disabled via network.
	Bit 2 Axis command		1 ≙ the inverter was disabled via axis command 0x2822:001 .
	Bit 6 Fault DC-bus		1 ≙ the inverter was inhibited due to a DC-bus error.
	Bit 7 Drive not ready		1 ≙ the inverter was disabled internally since the drive was not ready for operation. Possible causes: • Under/overvoltage in the DC bus • Defect device hardware
	Bit 8 Quick stop active		1 ≙ the inverter has been disabled by the "Quick stop" function.
	Bit 9 Motor data identification		1 ≙ the inverter was disabled by the "Automatic identification of the motor data" function.
	Bit 10 Automatic holding brake control		1 ≙ the inverter was disabled by the "Holding brake control" function.
	Bit 12 CiA402 Inverter disabled		1 ≙ the inverter was disabled by the internal state machine. The bit is only set if • operating mode 0x6060 (P301.00) = "CiA: Velocity mode [2]" and • state machine in the "Switch on disabled" state and • the state change has not been carried out via the "Disable operation" command.
	Bit 13 CiA402 Quick stop option code 2		1 ≙ the inverter has been disabled by the "Quick stop" function.
	Bit 14 Safe torque off (STO)		1 ≙ the inverter has been disabled by the integrated safety system.
Bit 15 CiA402 operation mode 0	1 ≙ the inverter has been disabled because the selection "No mode change/no mode assigned [0]" is set in 0x6060 (P301.00) .		



Diagnostics and fault elimination

Diagnostics parameter
Inverter diagnostics

Parameter	Name / value range / [default setting]	Info
0x282A:002 (P126.02)	Status words: Cause of quick stop (Status words: Cause of QSP) • Read only	Bit coded display of the cause(s) of quick stop.
	Bit 0 Flexible I/O configuration	1 ≡ quick stop was activated by the trigger set in 0x2631:003 (P400.03).
	Bit 1 Network	1 ≡ quick stop was activated via network.
	Bit 2 Axis command	1 ≡ quick stop was activated via axis command 0x2822:001.
	Bit 6 Error response	1 ≡ quick stop has been activated as a response to an error.
0x282A:003 (P126.03)	Status words: Cause of stop (Status words: Cause of stop) • Read only	Bit coded display of the cause(s) of stop.
	Bit 0 Flexible I/O: Start disabled	1 ≡ stop was activated by the trigger set in 0x2631:002 (P400.02).
	Bit 1 Flexible I/O: Run forward	1 ≡ stop has been activated due to cancellation of the command "Run forward (CW)".
	Bit 2 Flexible I/O: Run reverse	1 ≡ stop has been activated due to cancellation of the command "Run reverse (CCW)".
	Bit 3 Flexible I/O: Jog forward	1 ≡ stop has been activated due to cancellation of the command "Jog forward (CW)".
	Bit 4 Flexible I/O: Jog reverse	1 ≡ stop has been activated due to cancellation of the command "Jog reverse (CCW)".
	Bit 5 Network	1 ≡ stop was activated via network.
	Bit 6 Keypad	1 ≡ stop was activated via keypad.
	Bit 7 Control mode transition	1 ≡ stop has been activated due to a change of the operating mode.
	Bit 8 End of sequence	1 ≡ stop was activated by the "sequencer" function since the sequence is completed. • The bit is only set after the sequence is completed if End of sequence mode 0x402F (P824.00) is set = "Stop [1]" or "Stop and abort [2]".
0x282A:004	Status words: Extended status word • Read only	Bit-coded status word.
	Bit 8 Reversal	1 ≡ reversal active.
	Bit 10 Safe torque off (STO) active	1 ≡ "Safe torque off (STO)" function has been triggered by the integrated safety system.
0x282A:005 (P126.05)	Status words: Device status (Status words: Device status) • Read only	Display of the current inverter device state.
	0 Initialisation	
	2 Not ready to switch on	
	3 Switch on disabled	
	4 Ready to switch on	
	5 Switched on	
	6 Operation enabled	
	7 Disable operation	
	8 Shut down	
	9 Quick stop active	
	10 Fault reaction active	
	11 Fault	
0x282B:001 (P125.01)	Inverter diagnostics: Active control source (Inverter diag.: Active control) • Read only	Display of the control source that is currently active.
	0 Flexible I/O configuration	
	1 Network	
	2 Keypad	
	8 Keypad full control	

Diagnostics and fault elimination

Diagnostics parameter
Inverter diagnostics



Parameter	Name / value range / [default setting]	Info
0x282B:002 (P125.02)	Inverter diagnostics: Active setpoint source (Inverter diag.: Active setpoint) • Read only	Display of the setpoint source that is currently active.
	0 Not selected	
	1 Analog input 1	
	2 Analog input 2	
	3 Keypad Setpoint	
	4 HTL input	
	5 Network Setpoint	
	11 Setpoint preset 1	
	12 Setpoint preset 2	
	13 Setpoint preset 3	
	14 Setpoint preset 4	
	15 Setpoint preset 5	
	16 Setpoint preset 6	
	17 Setpoint preset 7	
	18 Setpoint preset 8	
	19 Setpoint preset 9	
	20 Setpoint preset 10	
	21 Setpoint preset 11	
	22 Setpoint preset 12	
	23 Setpoint preset 13	
	24 Setpoint preset 14	
	25 Setpoint preset 15	
	31 Segment preset 1	
	32 Segment preset 2	
	33 Segment preset 3	
	34 Segment preset 4	
35 Segment preset 5		
36 Segment preset 6		
37 Segment preset 7		
38 Segment preset 8		
39 Last segment		
50 Motor potentiometer		
51 PID setpoint (from version 04.00)		
0x282B:003 (P125.03)	Inverter diagnostics: Keypad LCD status (Inverter diag.: Keypad LCD stat.) • Read only	Bit-coded state of the keypad status displays.
	Bit 0 LOC	1 ≙ local keypad control active.
	Bit 1 REM	1 ≙ remote control via terminals, network, etc. active.
	Bit 2 MAN	1 ≙ manual setpoint selection via keypad active.
	Bit 3 Auto	1 ≙ automatic setpoint selection via terminals, network, etc. active.
	Bit 4 Set	1 ≙ a parameter setting has been changed but not been saved yet in the memory module with mains failure protection.
0x282B:004 (P125.04)	Inverter diagnostics: Active drive mode (Inverter diag.: Drive mode) • Read only	Display of the active drive mode.
	0 Velocity mode	"Velocity mode" active.
	1 PID control	PID control active.
	2 Torque mode (from version 03.00)	"Torque mode" active.
	4 Jog operation	"Jog forward (CW)" or "Jog reverse (CCW)" function active.



Diagnostics and fault elimination

Diagnostics parameter
Network diagnostics

Parameter	Name / value range / [default setting]	Info
0x2831	Inverter status word • Read only	Bit-coded status word of the internal motor control.
	Bit 1 Speed 1 limited	1 ≡ input of speed controller 1 in limitation.
	Bit 2 Speed limited	1 ≡ output of speed controller 1 in limitation.
	Bit 3 Torque limited	1 ≡ setpoint torque in limitation.
	Bit 4 Current limited	1 ≡ setpoint current in limitation.
	Bit 5 Speed 2 limited	1 ≡ input of the speed controller 2 in "torque mode" in limitation.
	Bit 6 Upper speed limit active	1 ≡ in "torque mode", the speed is limited to upper speed limit 0x2946:001 (P340.01) .
	Bit 7 Lower speed limit active	1 ≡ in "torque mode", the speed is limited to lower speed limit 0x2946:002 (P340.02) .
	Bit 10 Output frequency limited	1 ≡ setpoint frequency with V/f operation in limitation.
	Bit 11 Magnetisation completed	1 ≡ during V/f operation, the factor 7 rotor time constant has passed (calculated from the time at which the inverter was enabled without restart on the fly and with a total motor current of 20 % rated motor current for the first time). Otherwise 0.
Bit 12 Motor phase error	1 ≡ motor phase failure detection active.	
Bit 14 Error reset blocking time active	1 ≡ the fault can only be reset when the blocking time has elapsed.	
0x2833	Inverter status word 2 • Read only	Bit-coded status word 2 of the inverter.
	Bit 1 Manual test mode active	1 ≡ manual test mode active.
	Bit 2 Manual control active	1 ≡ manual control active.
	Bit 6 DC braking active	1 ≡ DC braking active.
0x2DAC (P119.00)	Keypad status (Keypad status) • Read only	Bit-coded display of the keypad status.
	Bit 0 Start Key	1 ≡ keypad start key  pressed.
	Bit 1 Stop Key	1 ≡ keypad stop key  pressed.
	Bit 2 Up arrow	1 ≡ keypad up-arrow key  pressed.
	Bit 3 Down arrow	1 ≡ keypad down-arrow key  pressed.
	Bit 4 Enter Key	1 ≡ keypad enter key  pressed.
Bit 5 Back key	1 ≡ keypad back key  pressed.	
0x2DAD (P120.00)	Internal hardware states (Int. HW states) • Read only	Bit-coded display of internal hardware states.
	Bit 0 Relay	0 ≡ X9/NO-COM open and NC-COM closed. 1 ≡ X9/NO-COM closed and NC-COM open.
	Bit 1 Digital output 1	0 ≡ LOW level, 1 ≡ HIGH level.
	Bit 2 Digital output 2	
	Bit 10 Charge Relay	1 ≡ precharging of the DC bus via charge relay is active.
0x603F (P150.00)	Error code (Error code) • Read only	Error message

5.2.4 Network diagnostics

The following parameters show some general information with regard to the network option available and the network.

Further fieldbus-specific diagnostic parameters are described in the following subchapters.

Parameter	Name / value range / [default setting]	Info
0x282B:005 (P125.05)	Inverter diagnostics: Most recently used control register (Inverter diag.: Netw. contr.reg.) • Read only	Display of the network register for the control that was accessed last (e. g. 0x6040 or 0x400B:1). • Format: 0xiiii:ss00 (iiii = hexadecimal index, ss = hexadecimal subindex) • The lowest byte is always 0x00.

Diagnostics and fault elimination

Diagnostics parameter
Network diagnostics



Parameter	Name / value range / [default setting]	Info
0x282B:006 (P125.06)	Inverter diagnostics: Most recently used setpoint register (Inverter diag.: Netw. setp.reg.) • Read only	Display of the network register for setpoint selection that was accessed last (e. g. 0x6042 or 0x400B:3). • Format: 0xiiiiSS00 (iiii = hexadecimal index, SS = hexadecimal subindex) • The lowest byte is always 0x00.
0x400B:006 (P592.06)	Process input data: Velocity mode setpoint (Process data IN: Veloc. mode setp) -599.0 ... [0.0] ... 599.0 Hz	Mappable parameter for defining the setpoint for operating mode "MS: Velocity mode" via network. • If this parameter is to be used as standard setpoint source, the selection "Network [5]" must be set in 0x2860:001 (P201.01) . • If this bipolar setpoint is used, the direction of rotation cannot be controlled via the network control word. The direction of rotation is determined by the sign of the setpoint.
0x400B:007 (P592.07)	Process input data: PID setpoint (Process data IN: PID setpoint) -300.00 ... [0.00] ... 300.00 PID unit	Mappable parameter for defining the setpoint for the PID control via network. • If this parameter is to be used as standard setpoint source, the selection "Network [5]" must be set in 0x2860:002 (P201.02) .
0x400B:008 (P592.08)	Process input data: Torque mode setpoint (Process data IN: Torque mode setp) -32768 ... [0] ... 32767 Nm	Mappable parameter for defining the setpoint for operating mode "MS: Torque mode" via network. • If this parameter is to be used as standard setpoint source, the selection "Network [5]" must be set in 0x2860:003 (P201.03) . • The scaling factor can be set in 0x400B:009 (P592.09) . • Scaled torque setpoint = torque setpoint (0x400B:008) / 2 ^{scaling factor} Example: • Torque setpoint (0x400B:008) = 345 [Nm] • Scaling factor (0x400C:009) = 3 • Scaled torque setpoint = 345 [Nm] / 2 ³ = 43.125 [Nm]
0x231F:001 (P500.01)	Module ID: Active module ID (Module ID: Active module ID) • Read only 48 No network 67 CANopen 71 EtherNet/IP (from version 02.00) 80 PROFIBUS 82 ProfiNet (from version 02.00) 84 EtherCAT (from version 02.00) 86 Modbus TCP/IP 87 Modbus	Display of the network options currently configured in the inverter. • With the help of this module ID, the keypad only shows the communication parameters relevant to the respective network. Note! When switched on, the inverter checks whether the parameter settings saved in the memory module match the inverter hardware and firmware. In case of an incompatibility, a corresponding error message is output. For details see chapter " Data handling " (section "Hardware and firmware updates/downgrades"). 115
0x231F:002 (P500.02)	Module ID: Module ID connected (Module ID: Module ID conn.) • Read only • For the meaning of the display see parameter 0x231F:001 (P500.01) . 201	Display of the network option currently available in the inverter. Note! When switched on, the inverter checks whether the parameter settings saved in the memory module match the inverter hardware and firmware. In case of an incompatibility, a corresponding error message is output. For details see chapter " Data handling " (section "Hardware and firmware updates/downgrades"). 115
0x400B:009 (P592.09)	Process input data: Torque scaling (Process data IN: Torque scaling) -128 ... [0] ... 127 • From version 02.00	Scaling factor for torque setpoint 0x400B:008 (P592.08) and actual torque value 0x400C:007 (P593.07) via network. • With the setting 0, no scaling takes place.

Related topics

► [Configuring the network](#) [199](#)



5.2.4.1 CANopen diagnostics

The following parameters serve to diagnose the CANopen interface and communication via CANopen.

Preconditions

Control unit (CU) of the inverter is provided with CANopen.

Parameter	Name / value range / [default setting]	Info
0x1000	Device type • Read only	CANopen device profile according CANopen specification CiA 301/ CiA 402. Specifies the axis type: <ul style="list-style-type: none"> • 0x01010192 ≡ single axis • 0x02010192 ≡ double axis • 0x01020192 ≡ servo single axis • 0x02020192 ≡ servo double axis • 0x01030192 ≡ stepper single axis • 0x02030192 ≡ stepper double axis
0x1001	Error register • Read only	Bit-coded error status. <ul style="list-style-type: none"> • Bit 0 is set if an error is active. The other bits signalise which group the active error belongs to: <ul style="list-style-type: none"> • Bit 1: Current error • Bit 2: Voltage error • Bit 3: Temperature error • Bit 4: Communication error • Bit 5: Device profile-specific error • Bit 6: Reserved (always 0) • Bit 7: Manufacturer-specific error
0x1008	Manufacturer device name • Read only	Display of the manufacturer device name.
0x1009	Manufacturer hardware version • Read only	Display of the manufacturer hardware version.
0x100A	Manufacturer software version • Read only	Display of the manufacturer software version.
0x1018:001	Identity object: Vendor ID • Read only	Display of the manufacturer's identification number. <ul style="list-style-type: none"> • The identification number allocated to Lenze by the organisation "CAN in Automation e. V." is "0x0000003B".
0x1018:002	Identity object: Product code • Read only	Display of the product code of the inverter.
0x1018:003	Identity object: Revision number • Read only	Display of the main and subversion of the firmware.
0x1018:004	Identity object: Serial number • Read only	Display of the serial number of the inverter.
0x2302:001 (P511.01)	Active CANopen settings: Active node ID (CANopen diag.: Active node ID) • Read only	Display of the active node address.
0x2302:002 (P511.02)	Active CANopen settings: Active baud rate (CANopen diag.: Active baud rate) • Read only	Display of the active baud rate.
	0 Automatic (from version 03.00)	
	1 20 kbps	
	2 50 kbps	
	3 125 kbps	
	4 250 kbps	
	5 500 kbps	
	6 800 kbps	
7 1 Mbps		

Diagnostics and fault elimination

Diagnostics parameter
Network diagnostics



Parameter	Name / value range / [default setting]	Info
0x2307 (P515.00)	CANopen time-out status (Time-out status) • Read only	Bit-coded status display of the CAN time monitoring functions.
	Bit 0 RPDO1-Timeout	1 ≙ RPDO1 was not received within the monitoring time or not with the sync configured. • Status is reset automatically after the RPDO has been received again. • Setting of monitoring time for RPDO1 in 0x1400:005 (P540.05) .
	Bit 1 RPDO2-Timeout	1 ≙ RPDO2 was not received within the monitoring time or not with the sync configured. • Status is reset automatically after the RPDO has been received again. • Setting of monitoring time for RPDO2 in 0x1401:005 (P541.05) .
	Bit 2 RPDO3-Timeout	1 ≙ RPDO3 was not received within the monitoring time or not with the sync configured. • Status is reset automatically after the RPDO has been received again. • Setting of monitoring time for RPDO3 in 0x1402:005 (P542.05) .
	Bit 8 Heartbeat-Timeout Consumer 1	1 ≙ within the "Heartbeat Consumer Time", no heartbeat telegram was received from node 1 to be monitored. • Status can only be reset by mains switching or error reset. • "Heartbeat Consumer Time" setting in 0x1016:001 (P520.01) .
	Bit 9 Heartbeat-Timeout Consumer 2	1 ≙ within the "Heartbeat Consumer Time", no heartbeat telegram was received from node 2 to be monitored. • Status can only be reset by mains switching or error reset. • "Heartbeat Consumer Time" setting in 0x1016:002 (P520.02) .
	Bit 10 Heartbeat-Timeout Consumer 3	1 ≙ within the "Heartbeat Consumer Time", no heartbeat telegram was received from node 3 to be monitored. • Status can only be reset by mains switching or error reset. • "Heartbeat Consumer Time" setting in 0x1016:003 (P520.03) .
	Bit 11 Heartbeat-Timeout Consumer 4	1 ≙ within the "Heartbeat Consumer Time", no heartbeat telegram was received from node 4 to be monitored. • Status can only be reset by mains switching or error reset. • "Heartbeat Consumer Time" setting in 0x1016:004 (P520.04) .
0x2308 (P516.00)	CANopen status (CANopen status) • Read only	Display of the current fieldbus state
	0 Initialisation	Fieldbus initialisation active. • The initialisation is started automatically at mains connection. During this phase, the inverter is not involved in the data exchange process on the CAN bus. • All CAN-relevant parameters are initialised with the saved settings. • When the initialisation process has been completed, the inverter automatically adopts the "Pre-Operational" state.
	1 Reset node	"Reset Node" NMT command active. • All parameters are initialised with the saved settings (not only the CAN-relevant parameters).
	2 Reset communication	"Reset Communication" NMT command active. • Initialisation of all CAN-relevant parameters with the values stored.
	4 Stopped	Only network management telegrams can be received.
	5 Operational	Parameter data and process data can be received. If defined, process data is sent as well.
	127 Pre-Operational	Parameter data can be received, process data are ignored.
0x2309 (P517.00)	CANopen controller status (CAN contr.status) • Read only	Status display of the internal CANopen controller.
	1 Error active	The inverter is a fully-fledged communication node at the CANopen network. It is able to transmit and receive data and to report faults.
	2 Error passive	The inverter can only passively indicate faulty reception via the ACK field.
	3 Bus off	The inverter is electrically separated from the CANopen network. In order to exit this state, the CANopen interface must be reset. An automatic restart is implemented.
0x230A:001 (P580.01)	CANopen statistics: PDO1 received (CAN statistics: PDO1 received) • Read only	Display of the number of PDO1 telegrams received.



Diagnostics and fault elimination

Diagnostics parameter
Network diagnostics

Parameter	Name / value range / [default setting]	Info
0x230A:002 (P580.02)	CANopen statistics: PDO2 received (CAN statistics: PDO2 received) • Read only	Display of the number of PDO2 telegrams received.
0x230A:003 (P580.03)	CANopen statistics: PDO3 received (CAN statistics: PDO3 received) • Read only	Display of the number of PDO3 telegrams received.
0x230A:005 (P580.05)	CANopen statistics: PDO1 transmitted (CAN statistics: PDO1 transmitted) • Read only	Display of the number of PDO1 telegrams sent.
0x230A:006 (P580.06)	CANopen statistics: PDO2 transmitted (CAN statistics: PDO2 transmitted) • Read only	Display of the number of PDO2 telegrams sent.
0x230A:007 (P580.07)	CANopen statistics: PDO3 transmitted (CAN statistics: PDO3 transmitted) • Read only	Display of the number of PDO3 telegrams sent.
0x230A:009 (P580.09)	CANopen statistics: SDO1 telegrams (CAN statistics: SDO1 counter) • Read only	Display of the number of SDO1 telegrams.
0x230A:010 (P580.10)	CANopen statistics: SDO2 telegrams (CAN statistics: SDO2 counter) • Read only	Display of the number of SDO2 telegrams.
0x230B (P518.00)	CANopen error counter (CAN errorcounter) • Read only	Display of the total number of CAN faults that have occurred.

Related topics

► [CANopen](#) 233

5.2.4.2 Modbus diagnostics

The following parameters serve to diagnose the Modbus interface and communication via Modbus.

Preconditions

Control unit (CU) of the inverter is provided with Modbus.

Parameter	Name / value range / [default setting]	Info
0x2322:001 (P511.01)	Active Modbus settings: Active node ID (Modbus diag.: Active node ID) • Read only	Display of the active node address.
0x2322:002 (P511.02)	Active Modbus settings: Active baud rate (Modbus diag.: Active baud rate) • Read only	Display of the active baud rate.
0x2322:003 (P511.03)	Active Modbus settings: Data format (Modbus diag.: Data format) • Read only	Display of the active data format.
0x232A:001 (P580.01)	Modbus statistics: Messages received (Modbus statistic: Mess. received) • Read only	Display of the total number of messages received. • This counter counts both valid and invalid messages. • After the maximum value has been reached, the counter starts again "0".
0x232A:002 (P580.02)	Modbus statistics: Valid messages received (Modbus statistic: Val. mess. rec.) • Read only	Display of the number of valid messages received. • After the maximum value has been reached, the counter starts again "0".
0x232A:003 (P580.03)	Modbus statistics: Messages with exceptions (Modbus statistic: Mess. w. exc.) • Read only	Display of the number of messages with exceptions that have been received. • After the maximum value has been reached, the counter starts again "0".
0x232A:004 (P580.04)	Modbus statistics: Messages with errors (Modbus statistic: Mess. w. errors) • Read only	Display of the number of messages received with a faulty data integrity (parity, CRC). • After the maximum value has been reached, the counter starts again "0".

Diagnostics and fault elimination

Diagnostics parameter
Network diagnostics



Parameter	Name / value range / [default setting]	Info
0x232A:005 (P580.05)	Modbus statistics: Messages sent (Modbus statistic: Messages sent) • Read only	Display of the total number of messages sent. • After the maximum value has been reached, the counter starts again "0".

Related topics

► [Modbus RTU](#) [255](#)

5.2.4.3 PROFIBUS diagnostics

The following parameters serve to diagnose the PROFIBUS interface and communication via PROFIBUS.

Preconditions

Control unit (CU) of the inverter is provided with PROFIBUS.

Parameter	Name / value range / [default setting]	Info
0x2342:001 (P511.01)	Active PROFIBUS settings: Active station address (PROFIBUS diag.: Act.station addr) • Read only	Display of the active station address.
0x2342:002 (P511.02)	Active PROFIBUS settings: Active baud rate (PROFIBUS diag.: Active baud rate) • Read only	Display of the active baud rate.
	0 12 Mbps	
	1 6 Mbps	
	2 3 Mbps	
	3 1.5 Mbps	
	4 500 kbps	
	5 187.5 kbps	
	6 93.75 kbps	
	7 45.45 kbps	
	8 19.2 kbps	
9 9.6 kbps		
15 Search	Automatic baud rate detection active.	
0x2342:003 (P511.03)	Active PROFIBUS settings: Watchdog time (PROFIBUS diag.: Watchdog time) • Read only	Display of the watchdog monitoring time specified by the master. • Monitoring starts with the arrival of the first telegram. • When a value of "0" is displayed, the monitoring function is deactivated. • A change in the watchdog monitoring time in the master is effective immediately.
0x2348:001 (P516.01)	PROFIBUS Status: Bus status (PROFIBUS Status: Bus status) • Read only	Display of the current DP state machine state (DP-STATE).
	0 WAIT_PRM	After the run-up, the inverter (slave) is waiting for parameter data (CHK_PRM) from the master. All other frame types are not processed. Exchanging user data with the master is not possible yet.
	1 WAIT_CFG	The inverter (slave) is waiting for configuration data (CHK_CFG) from the master that define the structure of the cyclic frames.
	2 DATA_EXCH	Parameter and configuration data have been received and accepted by the inverter (slave). The inverter is in the "Data Exchange" state. It is now possible to exchange user data with the master.
0x2348:002 (P516.02)	PROFIBUS Status: Watchdog status (PROFIBUS Status: Watchdog status) • Read only	Display of the current state of the watchdog state machine (WD-STATE).
	0 BAUD_SEARCH	The inverter (slave) is able to detect the baud rate automatically.
	1 BAUD_CONTROL	After detecting the correct baud rate, the inverter (slave) status changes to BAUD_CONTROL, and the baud rate is monitored.
	2 DP_CONTROL	The DP_CONTROL state serves to the response monitoring of the master.



Diagnostics and fault elimination

Diagnostics parameter
Network diagnostics

Parameter	Name / value range / [default setting]	Info
0x2349 (P517.00)	PROFIBUS error (PROFIBUS error) • Read only	Bit-coded display of PROFIBUS errors.
	Bit 0 Watchdog elapsed	Communication with the PROFIBUS master is continuously interrupted, e. g. by cable break or failure of the PROFIBUS master. • No process data are sent to the inverter (slave) in the "Data Exchange" state. • When the watchdog monitoring time specified by the master has elapsed, the response set in 0x2859:001 (P515.01) is triggered in the inverter. Preconditions for a response by the inverter (slave): • The slave is in the "Data Exchange" state. • The watchdog monitoring time is configured correctly in the master (1 ... 65535 ms). If one of these preconditions is not met, the response to the absence of cyclic process data telegrams from the master is not executed.
	Bit 1 Data exchange completed	Data exchange via PROFIBUS has been terminated. • The inverter (slave) can be instructed by the master to exit the "Data Exchange" state. • If this state change is to be treated as an error in the inverter, the desired response can be set in 0x2859:002 (P515.02) .
	Bit 2 Incorrect configuration data	The inverter (slave) has received invalid configuration data from the master. • The response set in 0x2859:003 (P515.03) is effected.
	Bit 3 Initialisation error	An error has occurred during the initialisation of the PROFIBUS interface. • The response set in 0x2859:004 (P515.04) is effected.
Bit 4 Invalid process data	The inverter (slave) has received invalid process data from the master, e.g. no process data or deleted process data are sent by the "Stop" operating status in the master. • The response set in 0x2859:005 (P515.05) is effected.	
0x234A:001 (P580.01)	PROFIBUS statistics: Data cycles per second (PROFIBUS counter: Data cycles/sec.) • Read only	Display of the data cycles per second.
0x234A:002 (P580.02)	PROFIBUS statistics: Parameterization events (PROFIBUS counter: PRM events) • Read only	Display of the number of parameterisation events.
0x234A:003 (P580.03)	PROFIBUS statistics: Configuration events (PROFIBUS counter: CFG events) • Read only	Display of the number of configuration events.
0x234A:004 (P580.04)	PROFIBUS statistics: Diagnostics events (PROFIBUS counter: DIAG events) • Read only	Display of the number of diagnostic telegrams sent.
0x234A:005 (P580.05)	PROFIBUS statistics: C1 messages (PROFIBUS counter: C1 messages) • Read only	Display of the number of requests by the class 1 DPV1 master.
0x234A:006 (P580.06)	PROFIBUS statistics: C2 messages (PROFIBUS counter: C2 messages) • Read only	Display of the number of requests by the class 2 DPV1 master.
0x234A:007 (P580.07)	PROFIBUS statistics: Watchdog events (PROFIBUS counter: WD events) • Read only	Display of the number of watchdog events.
0x234A:008 (P580.08)	PROFIBUS statistics: Data exchange aborts (PROFIBUS counter: DataEx.event) • Read only	Display of the number of "Data Exchange exited" events.
0x234A:009 (P580.09)	PROFIBUS statistics: Total data cycles (PROFIBUS counter: Tot. data cycles) • Read only	Display of the number of cyclic process data received.

Related topics

► [PROFIBUS](#) 267

Diagnostics and fault elimination

Diagnostics parameter
Network diagnostics

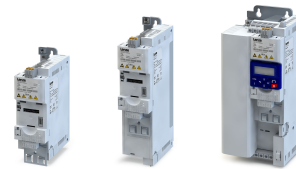

5.2.4.4 EtherNet/IP diagnostics

The following parameters serve to diagnose the EtherNet/IP interface and the communication via EtherNet/IP.

Preconditions

Control unit (CU) of the inverter is provided with EtherNet/IP.

Parameter	Name / value range / [default setting]	Info
0x23A2:001 (P511.01)	Active EtherNet/IP settings: IP address (EtherN/IP diag.: IP address) • Read only • From version 02.00	Display of the active IP address. The default setting 276605120 corresponds to the IP address 192.168.124.16. • 276605120 = 0x107CA8C0 → 0xC0.0xA8.0x7C.0x10 = 192.168.124.16
0x23A2:002 (P511.02)	Active EtherNet/IP settings: Subnet (EtherN/IP diag.: Subnet) • Read only • From version 02.00	Display of the active subnet mask. The default setting 16777215 corresponds to the subnet mask 255.255.255.0. • 16777215 = 0xFFFFFFFF → 0xFF.0xFF.0xFF.0x00 = 255.255.255.0
0x23A2:003 (P511.03)	Active EtherNet/IP settings: Gateway (EtherN/IP diag.: Gateway) • Read only • From version 02.00	Display of the active gateway address. Example: The setting 276344004 corresponds to the gateway address 196.172.120.16. • 276344004 = 0x1078ACC4 → 0xC4.0xAC.0x78.0x10 = 196.172.120.16
0x23A2:005 (P511.05)	Active EtherNet/IP settings: MAC address (EtherN/IP diag.: MAC address) • Read only • From version 02.00	Display of the active MAC address.
0x23A2:006 (P511.06)	Active EtherNet/IP settings: Multicast address (EtherN/IP diag.: Mcast address) • Read only • From version 02.00	Display of the active Multicast IP address. The default setting 3221373167 corresponds to the Multicast IP address 239.64.2.192. • 3221373167 = 0xC00240EF → 0xEF.0x40.0x02.0xC0 = 239.64.2.192
0x23A3 (P509.00)	EtherNet/IP switch position (EtherN. switch) • Read only • From version 02.00	Display of the rotary encoder switch settings at the last mains power-on.
0x23A5:001 (P519.01)	Active port settings: Port 1 (Port diagnostics: Port 1) • Read only • From version 02.00	Display of the active baud rate for Ethernet port 1.
	0 Not connected	
	1 10 Mbps/Half Duplex	
	2 10 Mbps/Full Duplex	
	3 100 Mbps/Half Duplex	
4 100 Mbps/Full Duplex		
0x23A5:002 (P519.02)	Active port settings: Port 2 (Port diagnostics: Port 2) • Read only • From version 02.00	Display of the active baud rate for Ethernet port 2.
	0 Not connected	
	1 10 Mbps/Half Duplex	
	2 10 Mbps/Full Duplex	
	3 100 Mbps/Half Duplex	
	4 100 Mbps/Full Duplex	
	5 Reserved	
6 Reserved		
0x23A6 (P513.00)	Quality of service (QualityOfService) • Read only • From version 02.00	Display if the QoS tag for prioritising the data packages to be transmitted is used.
	0 802.1Q Tag disable	
	1 802.1Q Tag enable	
0x23A8 (P516.00)	CIP module status (CIP module stat.) • Read only • From version 02.00	Display of the active CIP module status.



Parameter	Name / value range / [default setting]	Info
0x23A9 (P517.00)	EtherNet/IP status (EtherN/IP status) <ul style="list-style-type: none"> • Read only • From version 02.00 	Display of the active network status.

Related topics

▶ [EtherNet/IP](#) 288

5.2.4.5 PROFINET diagnostics

The following parameters serve to diagnose the PROFINET interface and the communication via PROFINET.

Preconditions

Control unit (CU) of the inverter is provided with PROFINET.

Parameter	Name / value range / [default setting]	Info	
0x2382:001 (P511.01)	Active PROFINET settings: IP address (PROFINET diag.: IP address) <ul style="list-style-type: none"> • Read only • From version 02.00 	Display of the active IP address.	
0x2382:002 (P511.02)	Active PROFINET settings: Subnet (PROFINET diag.: Subnet) <ul style="list-style-type: none"> • Read only • From version 02.00 	Display of the active subnet mask.	
0x2382:003 (P511.03)	Active PROFINET settings: Gateway (PROFINET diag.: Gateway) <ul style="list-style-type: none"> • Read only • From version 02.00 	Display of the gateway address.	
0x2382:004 (P511.04)	Active PROFINET settings: Station name (PROFINET diag.: Station name) <ul style="list-style-type: none"> • Read only • From version 02.00 	Display of the active station name.	
0x2382:005 (P511.05)	Active PROFINET settings: MAC Address (PROFINET diag.: MAC Address) <ul style="list-style-type: none"> • Read only • From version 02.00 	Display of the active MAC address.	
0x2388 (P516.00)	PROFINET status (PROFINET status) <ul style="list-style-type: none"> • Read only • From version 02.00 	Bit coded display of the current Bus status.	
	Bit 0	Initialized	After initialisation, the network component waits for a communication partner and the system power-up.
	Bit 1	Online	
	Bit 2	Connected	
	Bit 3	IP address error	The IP address is invalid. Valid IP addresses are defined according to RFC 3330.
	Bit 4	Hardware fault	
	Bit 6	Watchdog elapsed	PROFINET communication is continuously interrupted in the "Data_Exchange" state, e.g. by cable break or failure of the IO Controller. <ul style="list-style-type: none"> • PROFINET communication changes to the "No_Data_Exchange" state. When the watchdog monitoring time specified by the IO Controller has elapsed, the response set in 0x2859:001 (P515.01) is triggered in the inverter.
	Bit 7	Protocol error	
	Bit 8	PROFINET stack ok	
	Bit 9	PROFINET stack not configured	
Bit 10	Ethernet controller fault		
Bit 11	UDP stack fault		

Diagnostics and fault elimination

Diagnostics parameter
Network diagnostics



Parameter	Name / value range / [default setting]	Info	
0x2389:001 (P517.01)	PROFINET error: Error 1 (PROFINET error: Error 1)	<ul style="list-style-type: none"> The error values may occur in combination with the error values from parameter 0x2389:002 (P517.02). 	
	<ul style="list-style-type: none"> Read only From version 02.00 		
	0 No error		
	1 Reserved		
	2 Unit ID unknown		
	3 Max. units exceeded		
	4 Invalid size		
	5 Unit type unknown		
	6 Runtime plug error		
	7 Invalid argument		
	8 Service pending		
	9 Stack not ready		
10 Command unknown			
11 Invalid address descriptor			
0x2389:002 (P517.02)	PROFINET error: Error 2 (PROFINET error: Error2)	The parameter currently contains the error detected on the network. <ul style="list-style-type: none"> The error values may occur in combination with the error values from parameter 0x2389:001 (P517.01). 	
	<ul style="list-style-type: none"> Read only From version 02.00 		
	Bit 7 IP address error		The IP address is invalid. Valid IP addresses are defined according to RFC 3330.
	Bit 8 Station name problem		The station name must be assigned according to the PROFINET specification.
	Bit 9 DataExch left		
	Bit 10 Stack boot error		
	Bit 11 Stack online error		
	Bit 12 Stack state error		
Bit 13 Stack revision error			
Bit 14 Initialization problem			
Bit 15 Stack init error	The stack cannot be initiated with the user specifications. A reason might be, e. g., a station name that does not correspond to the PROFINET specification.		

Related topics

► [PROFINET](#) 329

5.2.4.6 EtherCAT diagnostics

The following parameters serve to diagnose the EtherCAT interface and the communication via EtherCAT.

Preconditions

The control unit (CU) of the inverter is provided with EtherCAT (from firmware 02.00).

Parameter	Name / value range / [default setting]	Info
0x1000	Device type <ul style="list-style-type: none"> Read only From version 02.00 	CANopen device profile according CANopen specification CiA 301/ CiA 402.
0x1008	Manufacturer device name <ul style="list-style-type: none"> Read only From version 02.00 	Display of the manufacturer device name.
0x1009	Manufacturer hardware version <ul style="list-style-type: none"> Read only From version 02.00 	Display of the manufacturer hardware version.
0x100A	Manufacturer software version <ul style="list-style-type: none"> Read only From version 02.00 	Display of the manufacturer software version.
0x1018:001	Identity object: Vendor ID <ul style="list-style-type: none"> Read only From version 02.00 	Display of the manufacturer's identification number.



Diagnostics and fault elimination

Diagnostics parameter
Network diagnostics

Parameter	Name / value range / [default setting]	Info
0x1018:002	Identity object: Product code • Read only • From version 02.00	Display of the product code of the inverter.
0x1018:003	Identity object: Revision number • Read only • From version 02.00	Display of the main and subversion of the firmware.
0x1018:004	Identity object: Serial number • Read only • From version 02.00	Display of the serial number of the inverter.
0x2362:004 (P511.04)	Active EtherCAT settings: Device identifier (EtherCAT diag.: Device ident.) • Read only • From version 02.00	Display of the clear device address in the network which is defined via rotary encoder switch or object 0x2361:004 (P510.04) .
0x2362:006 (P511.06)	Active EtherCAT settings: Station address (EtherCAT diag.: Station address) • Read only • From version 02.00	Display of the active station address.
0x2362:007 (P511.07)	Active EtherCAT settings: Tx length (EtherCAT diag.: Tx length) • Read only • From version 02.00	Display of the length of the transmitted cyclic data in bytes.
0x2362:008 (P511.08)	Active EtherCAT settings: Rx length (EtherCAT diag.: Rx length) • Read only • From version 02.00	Display of the length of the received cyclic data in bytes.
0x2368 (P516.00)	EtherCAT status (EtherCAT status) • Read only • From version 02.00	Display of the current network status.
	1 Initialisation	Network initialisation is active. • No PDO/SDO transmission. • Device identification is possible by network scan.
	2 Pre-Operational	The network is active. • SDO transmission (CoE communication via mailbox) is possible. • No PDO transmission.
	3 Bootstrap	Firmware update active. • For the firmware update, the FoE protocol is used. • No PDO transmission.
	4 Safe-Operational	SDO transmission (CoE communication via mailbox) is possible. PDO transmission: • The input data in the process image are updated. • The output data from the process image are not transmitted.
8 Operational	Normal operation • PDO/SDO transmission is possible. • Network synchronisation is successful (if used).	
0x2369 (P517.00)	EtherCAT error (EtherCAT error) • Read only • From version 02.00	Bit coded display of EtherCAT errors.

Related topics

► [EtherCAT](#) 343

Diagnostics and fault elimination

Diagnostics parameter

Diagnostics of the inputs and outputs



5.2.5 Diagnostics of the inputs and outputs

5.2.5.1 Digital inputs and outputs

The following parameters serve to diagnose the digital inputs and outputs of the inverter.

Parameter	Name / value range / [default setting]	Info	
0x60FD (P118.00)	Digital inputs (Digital inputs) • Read only	Bit coded display of the current state of the digital inputs	
	Bit 16	Level of digital input 1	0 ≡ LOW level, 1 ≡ HIGH level. Digital input 6 and digital input 7 are only available with application I/O.
	Bit 17	Level of digital input 2	
	Bit 18	Level of digital input 3	
	Bit 19	Level of digital input 4	
	Bit 20	Level of digital input 5	
	Bit 21	Level of digital input 6	
	Bit 22	Level of digital input 7	
Bit 25	Internal interconnection of digital inputs	0 ≡ digital input terminals are set to HIGH level via pull-up resistors. 1 ≡ digital input terminals are set to LOW level via pull-down resistors.	
0x2DAD (P120.00)	Internal hardware states (Int. HW states) • Read only	Bit-coded display of internal hardware states.	
	Bit 0	Relay	0 ≡ X9/NO-COM open and NC-COM closed. 1 ≡ X9/NO-COM closed and NC-COM open.
	Bit 1	Digital output 1	0 ≡ LOW level, 1 ≡ HIGH level.
	Bit 2	Digital output 2	
	Bit 10	Charge Relay	1 ≡ precharging of the DC bus via charge relay is active.
0x4016:005	Digital output 1: Terminal state • Read only	Display of the logic state of output terminal X3/DO1.	
	0		FALSE
	1		TRUE
0x4016:006	Digital output 1: Trigger signal state • Read only	Display of the logic state of the trigger signal for digital output 1 (without taking a ON/OFF delay set and inversion into consideration).	
	0		FALSE
	1		TRUE
0x4017:005	Digital output 2: Terminal state • Read only • Only available for application I/O.	Display of the logic state of output terminal X3/DO2.	
	0		FALSE
	1		TRUE
0x4017:006	Digital output 2: Trigger signal state • Read only • Only available for application I/O.	Display of the logic state of the trigger signal for digital output 2 (without taking a ON/OFF delay set and inversion into consideration).	
	0		FALSE
	1		TRUE
0x4018:005	Relay: Relay state • Read only	Display of the logic state of the relay.	
	0		FALSE
	1		TRUE
0x4018:006	Relay: Trigger signal state • Read only	Display of the logic state of the trigger signal for the relay (without taking a ON/OFF delay set and inversion into consideration).	
	0		FALSE
	1		TRUE

Related topics

▶ [Configuration of digital inputs](#) 565

▶ [Configuration of digital outputs](#) 574



Diagnostics and fault elimination

Diagnostics parameter
Diagnostics of the inputs and outputs

5.2.5.2 Analog inputs and outputs

The following parameters serve to diagnose the analog inputs and outputs of the inverter.

Parameter	Name / value range / [default setting]	Info
0x2DA4:001 (P110.01)	Diagnostics of analog input 1: Value in percent (AI1 diagnostics: AI1 terminal %) • Read only: x.x %	Display of the current input value at X3/AI1 scaled as value in percent. • 100 % \equiv 10 V or 20 mA or 5 V
0x2DA4:002 (P110.02)	Diagnostics of analog input 1: Frequency value (AI1 diagnostics: AI1 scaled freq.) • Read only: x.x Hz	Display of the current input value at X3/AI1 scaled as a frequency value. • The standard setpoint source for operating mode 0x6060 (P301.00) = "MS: Velocity mode [-2]" is selected in 0x2860:001 (P201.01).
0x2DA4:003 (P110.03)	Diagnostics of analog input 1: Process controller value (AI1 diagnostics: AI1 scaled PID) • Read only: x.xx PID unit	Display of the current input value at X3/AI1 scaled as a process controller value. • The standard setpoint source for the reference value of PID control is selected in 0x2860:002 (P201.02).
0x2DA4:004 (P110.04)	Diagnostics of analog input 1: Torque value (AI1 diagnostics: AI1 scaled torq.) • Read only: x.x %	Display of the current input value at X3/AI1 scaled as a percentage torque value. • 100 % \equiv permissible maximum torque 0x6072 (P326.00) • The standard setpoint source for operating mode 0x6060 (P301.00) = "MS: Torque mode [-1]" is selected in 0x2860:003 (P201.03).
0x2DA4:016 (P110.16)	Diagnostics of analog input 1: Status (AI1 diagnostics: AI1 status) • Read only • From version 04.00	Bit-coded display of the status of analog input 1 (X3/AI1).
Bit 0	Mode 0: 0 ... 10 VDC active	
Bit 1	Mode 1: 0 ... 5 VDC active	
Bit 2	Mode 2: 2 ... 10 VDC active	
Bit 3	Mode 3: -10 ... 10 VDC active	
Bit 4	Mode 4: 4 ... 20 mA active	
Bit 5	Mode 5: 0 ... 20 mA active	
Bit 6	24 V supply OK	
Bit 7	Calibration successful	
Bit 8	Monitoring threshold exceeded/not reached	
Bit 9	Input current too low (mode 4)	
Bit 10	Input voltage too low (mode 2)	
Bit 11	Input voltage too high (mode 4)	
0x2DA5:001 (P111.01)	Diagnostics of analog input 2: Value in percent (AI2 diagnostics: AI2 terminal %) • Read only: x.x %	Display of the current input value at X3/AI2 scaled as a value in percent. • 100 % \equiv 10 V or 20 mA or 5 V
0x2DA5:002 (P111.02)	Diagnostics of analog input 2: Frequency value (AI2 diagnostics: AI2 scaled freq.) • Read only: x.x Hz	Display of the current input value at X3/AI2 scaled as a frequency value. • The standard setpoint source for operating mode 0x6060 (P301.00) = "MS: Velocity mode [-2]" is selected in 0x2860:001 (P201.01).
0x2DA5:003 (P111.03)	Diagnostics of analog input 2: Process controller value (AI2 diagnostics: AI2 scaled PID) • Read only: x.xx PID unit	Display of the current input value at X3/AI2 scaled as a process controller value. • The standard setpoint source for the reference value of PID control is selected in 0x2860:002 (P201.02).
0x2DA5:004 (P111.04)	Diagnostics of analog input 2: Torque value (AI2 diagnostics: AI2 scaled torq.) • Read only: x.x %	Display of the current input value at X3/AI2 scaled as a percentage torque value. • 100 % \equiv permissible maximum torque 0x6072 (P326.00)

Diagnostics and fault elimination

Diagnostics parameter
Wireless-LAN diagnostics



Parameter	Name / value range / [default setting]	Info	
0x2DA5:016 (P111.16)	Diagnostics of analog input 2: Status (AI2 diagnostics: AI2 status)	Bit-coded display of the status of analog input 2 (X3/AI2).	
	• Read only		
	• From version 04.00		
	Bit 0		Mode 0: 0 ... 10 VDC active
	Bit 1		Mode 1: 0 ... 5 VDC active
	Bit 2		Mode 2: 2 ... 10 VDC active
	Bit 3		Mode 3: -10 ... 10 VDC active
	Bit 4		Mode 4: 4 ... 20 mA active
	Bit 5		Mode 5: 0 ... 20 mA active
	Bit 6		24 V supply OK
	Bit 7		Calibration successful
	Bit 8		Monitoring threshold exceeded/not reached
Bit 9	Input current too low		
Bit 10	Input voltage too low		
Bit 11	Input voltage too high		
0x2DAA:001 (P112.01)	Diagnostics of analog output 1: Voltage (AO1 diagnostics: AO1 Voltage)	Display of the current output voltage at X3/AO1.	
• Read only: x.xx V			
0x2DAA:002 (P112.02)	Diagnostics of analog output 1: Current (AO1 diagnostics: AO1 Current)	Display of the present output current at X3/AO1.	
• Read only: x.xx mA			
0x2DAB:001 (P113.01)	Diagnostics of analog output 2: Voltage (AO2 diagnostics: AO2 Current)	Display of the current output voltage at X3/AO2.	
• Read only: x.xx V			
• Only available for application I/O.			
0x2DAB:002 (P113.02)	Diagnostics of analog output 2: Current (AO2 diagnostics: AO2 Voltage)	Display of the present output current at X3/AO2.	
• Read only: x.xx mA			
• Only available for application I/O.			

Related topics

- ▶ [Configuration of analog inputs](#) 568
- ▶ [Configuration of analog outputs](#) 584

5.2.6 Wireless-LAN diagnostics

The following parameters serve to diagnose the WLAN module and the WLAN communication.

Preconditions

WLAN module has been plugged onto the interface X16 on the front of the inverter.

Parameter	Name / value range / [default setting]	Info	
0x2442:001	Active WLAN settings: Active IP address	Display of the active IP address.	
• Read only		• If DHCP is activated, the active IP address usually derives from the configured static IP address of the device.	
• From version 02.00			
0x2442:002	Active WLAN settings: Active netmask	Display of the active netmask.	
• Read only			
• From version 02.00			
0x2442:003	Active WLAN settings: Active gateway	Display of the active gateway IP address.	
• Read only			
• From version 02.00			
0x2442:004	Active WLAN settings: Active module mode	Display of the active data source for the WLAN settings.	
	• Read only	• This parameter indicates whether the settings used come from the inverter or from the WLAN module.	
	• From version 02.00		
	0	Inverter	The WLAN settings saved in the inverter are used.
	1	Standalone	The WLAN settings saved in the WLAN module are used.
0x2442:005	Active WLAN settings: MAC address	Display of the MAC address of the WLAN module.	
• Read only			
• From version 02.00			



Diagnostics and fault elimination

Diagnostics parameter
Setpoint diagnostic

Parameter	Name / value range / [default setting]	Info
0x2448:001	WLAN status: Connection time • Read only • From version 02.00	Display of the connection time in [s] since the current connection was established.
0x2448:002	WLAN status: Number of connections • Read only • From version 02.00	In access point mode: Display of the number of currently connected clients. In client mode: 0 ≡ not connected; 1 ≡ connected with external WLAN network.
0x2448:003	WLAN status: Rx frame counter • Read only • From version 02.00	Display of the number of request received via WLAN.
0x2448:004	WLAN status: Error statistics • Read only • From version 02.00	Display of the quality of the WLAN connection. A display value > 0 indicates communication problems.
0x2449	WLAN error • Read only • From version 02.00	Bit coded display of WLAN errors.
	Bit 2 WLAN error	
	Bit 3 Memory problem	
	Bit 4 WLAN connection problem	
	Bit 7 WLAN off	
	Bit 9 Client mode off	
	Bit 12 TCP/IP configuration error	
	Bit 13 Password length	
Bit 14 Access denied		

Related topics

▶ [Wireless LAN \(WLAN\)](#) [□ 375](#)

5.2.7 Setpoint diagnostic

The following parameters show the current setpoints of different setpoint sources.

Parameter	Name / value range / [default setting]	Info
0x282B:007	Inverter diagnostics: Default frequency setpoint • Read only: x.x Hz • From version 03.00	Display of the frequency setpoint of the standard setpoint source set in 0x2860:001 (P201.01) .
0x282B:008	Inverter diagnostics: Preset frequency setpoint • Read only: x.x Hz • From version 03.00	Display of the preset frequency setpoint selected via the four functions "Activate preset (bit 0)" ... "Activate preset (bit 3)". ▶ Setpoint source of preset setpoints □ 522
0x282B:009	Inverter diagnostics: Actual frequency setpoint • Read only: x.x Hz • From version 03.00	Display of the currently selected frequency setpoint that is internally transferred to the motor control.
0x282B:010	Inverter diagnostics: Default PID setpoint • Read only: x.xx PID unit • From version 03.00	Display of the PID control value of the standard setpoint source set in 0x2860:002 (P201.02) .
0x282B:011	Inverter diagnostics: Preset PID setpoint • Read only: x.xx PID unit • From version 03.00	Display of the preset PID setpoint selected via the four functions "Activate preset (bit 0)" ... "Activate preset (bit 3)". ▶ Setpoint source of preset setpoints □ 522
0x282B:012	Inverter diagnostics: Default torque setpoint • Read only: x.x % • From version 03.00	Display of the torque setpoint of the standard setpoint source set in 0x2860:003 (P201.03) . • 100 % ≡ Motor rated torque 0x6076 (P325.00)
0x282B:013	Inverter diagnostics: Preset torque setpoint • Read only: x.x % • From version 03.00	Display of the preset torque setpoint selected via the four functions "Activate preset (bit 0)" ... "Activate preset (bit 3)". ▶ Setpoint source of preset setpoints □ 522
0x2948:001	Actual torque setpoint • Read only: x.x % • From version 03.00	Display of the currently selected torque setpoint that is internally transferred to the motor control. • 100 % ≡ Motor rated torque 0x6076 (P325.00)
0x2DAE:010	Sequencer diagnostics: Frequency setpoint • Read only: x.x Hz • From version 03.00	Display of the current frequency setpoint of the "sequencer" function. ▶ Sequencer □ 462

Diagnostics and fault elimination

Diagnostics parameter
Process controller status

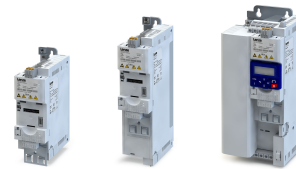

Parameter	Name / value range / [default setting]	Info
0x2DAE:011	Sequencer diagnostics: PID setpoint <ul style="list-style-type: none"> Read only: x.xx PID unit From version 03.00 	Display of the current PID control value of the "sequencer" function. ▶ Sequencer 462
0x2DAE:012	Sequencer diagnostics: Torque setpoint <ul style="list-style-type: none"> Read only: x.x % From version 03.00 	Display of the current torque setpoint of the "sequencer" function. <ul style="list-style-type: none"> 100 % ≙ Motor rated torque 0x6076 (P325.00) ▶ Sequencer 462
0x4009:004	MOP values saved: Frequency setpoint <ul style="list-style-type: none"> Read only: x.x Hz 	Display of the last MOP value saved internally for the operating mode "MS: Velocity mode".
0x4009:005	MOP values saved: PID setpoint <ul style="list-style-type: none"> Read only: x.xx PID unit 	Display of the last MOP value saved internally for the reference value of the PID control.
0x4009:006	MOP values saved: Torque setpoint <ul style="list-style-type: none"> Read only: x.x % 	Display of the last MOP value saved internally for the operating mode "MS: Torque mode".

Related topics

- ▶ [Selection of setpoint source](#) [122](#)
- ▶ [Setpoint change-over](#) [514](#)

5.2.8 Process controller status

The following parameters serve to diagnose the process controller.

Parameter	Name / value range / [default setting]	Info																
0x401F:001 (P121.01)	Current setpoint (PID setpoint) <ul style="list-style-type: none"> Read only: x.xx PID unit 	Display of the current reference value (setpoint) for the process controller.																
0x401F:002 (P121.02)	Current process variable (PID process var.) <ul style="list-style-type: none"> Read only: x.xx PID unit 	Display of the current controlled variable (actual value) fed back for the process controller.																
0x401F:003 (P121.03)	Status (PID status) <ul style="list-style-type: none"> Read only <table border="1" style="width: 100%; border-collapse: collapse;"> <tr> <td style="width: 10%;">Bit 0</td> <td>Process controller off</td> </tr> <tr> <td>Bit 1</td> <td>PID output set to 0</td> </tr> <tr> <td>Bit 2</td> <td>PID I-component inhibited</td> </tr> <tr> <td>Bit 3</td> <td>PID influence shown</td> </tr> <tr> <td>Bit 4</td> <td>Setpoint = actual value</td> </tr> <tr> <td>Bit 5</td> <td>Idle state active</td> </tr> <tr> <td>Bit 6</td> <td>Reserved</td> </tr> <tr> <td>Bit 7</td> <td>Reserved</td> </tr> </table>	Bit 0	Process controller off	Bit 1	PID output set to 0	Bit 2	PID I-component inhibited	Bit 3	PID influence shown	Bit 4	Setpoint = actual value	Bit 5	Idle state active	Bit 6	Reserved	Bit 7	Reserved	Bit-coded status display of the process controller.
Bit 0	Process controller off																	
Bit 1	PID output set to 0																	
Bit 2	PID I-component inhibited																	
Bit 3	PID influence shown																	
Bit 4	Setpoint = actual value																	
Bit 5	Idle state active																	
Bit 6	Reserved																	
Bit 7	Reserved																	
0x401F:004	PID control value <ul style="list-style-type: none"> Read only: x.x Hz From version 03.00 	Display of the output frequency after the PID controller, but without any influencing factor.																
0x401F:005	PID Feedforward value <ul style="list-style-type: none"> Read only: x.x Hz From version 03.00 	Display of the feedforward control value for the process controller.																
0x401F:006	PID output value <ul style="list-style-type: none"> Read only: x.x Hz From version 03.00 	Display of the current process controller setpoint that is internally transferred to the motor control (considering the feedforward control value).																
0x401F:007	PID error value <ul style="list-style-type: none"> Read only: x.xx PID unit From version 03.00 	Display of the difference between reference value (setpoint) and fed back variable (actual value) of the process controller.																

Related topics

- ▶ [Configuring the process controller](#) [356](#)



5.2.9 Sequencer diagnostics

The following parameters serve to diagnose the "sequencer" function.

Parameter	Name / value range / [default setting]	Info
0x2DAE:001 (P140.01)	Sequencer diagnostics: Active step (Sequencer diag: Active Step) • Read only • From version 03.00	Display of the active step. • 0 ≡ no sequence active.
0x2DAE:002 (P140.02)	Sequencer diagnostics: Step time elapsed (Sequencer diag: StepTime elapsed) • Read only: x.x s • From version 03.00	Display of the time that has passed since the start of the current step.
0x2DAE:003 (P140.03)	Sequencer diagnostics: Step time remaining (Sequencer diag: StepTime remain) • Read only: x.x s • From version 03.00	Display of the residual time for the current step.
0x2DAE:004 (P140.04)	Sequencer diagnostics: Steps complete (Sequencer diag: Steps complete) • Read only • From version 03.00	Display of the number of steps that have been made since the start of the sequence.
0x2DAE:005 (P140.05)	Sequencer diagnostics: Steps remaining (Sequencer diag: Steps remain) • Read only • From version 03.00	Display of the residual number of steps until the current sequence is completed. This includes the current step.
0x2DAE:006 (P140.06)	Sequencer diagnostics: Active sequence (Sequencer diag: Active sequence) • Read only • From version 03.00	Display of the active sequence. • 0 ≡ no sequence active.
0x2DAE:007 (P140.07)	Sequencer diagnostics: Active segment (Sequencer diag: Active segment) • Read only • From version 03.00	Display of the active segment. • 0 ≡ no sequence active. • 255 ≡ final sequence active.
0x2DAE:008 (P140.08)	Sequencer diagnostics: Relative sequence time remaining (Sequencer diag: SeqTime remain %) • Read only: x % • From version 03.00	Display of the residual time of the sequence in [%].
0x2DAE:009 (P140.09)	Sequencer diagnostics: Absolute sequence time remaining (Sequencer diag: SeqTime remain) • Read only: x.x s • From version 03.00	Display of the residual time of the sequence in [s].

Related topics

▶ [Sequencer](#) 462

▶ [Sequencer control functions](#) 559

5.2.10 Device identification

The following parameters show some general information about the inverter.

Parameter	Name / value range / [default setting]	Info
0x2000:001 (P190.01)	Device data: Product code (Device data: Product code) • Read only	Product code of the complete device. Example: "I55AE155D10V10017S" • If control unit and power unit were ordered separately, the product code "XXXXXXXXXXXXXXXXXX" is displayed.
0x2000:002 (P190.02)	Device data: Serial number (Device data: Serial number) • Read only	Serial number of the complete device. Example: "0000000000000000XYZY" • If control unit and power unit were ordered separately, the serial number "XXXXXXXXXXXXXXXXXX" is displayed.
0x2000:004 (P190.04)	Device data: CU firmware version (Device data: CU firmware ver.) • Read only	Firmware version of the control unit. Example: "01.00.01.00"

Diagnostics and fault elimination

Diagnostics parameter
Device identification



Parameter	Name / value range / [default setting]	Info
0x2000:005 (P190.05)	Device data: CU firmware type (Device data: CU firmware type) • Read only	Firmware type of the control unit. Example: "IOFW51AC10"
0x2000:006 (P190.06)	Device data: CU bootloader version (Device data: CU bootlder ver.) • Read only	Bootloader version of the control unit. Example: "00.00.00.13"
0x2000:007 (P190.07)	Device data: CU bootloader type (Device data: CU bootlder type) • Read only	Bootloader type of the control unit. Example: "IOBL51AOnn"
0x2000:008 (P190.08)	Device data: Object directory version (Device data: OBD version) • Read only	Example: "108478"
0x2000:010 (P190.10)	Device data: PU firmware version (Device data: PU firmware ver.) • Read only	Firmware version of the power unit. Example: "00202"
0x2000:011 (P190.11)	Device data: PU firmware type (Device data: PU firmware type) • Read only	Firmware type of the power unit. Example: "IDFW5AA"
0x2000:012 (P190.12)	Device data: PU bootloader version (Device data: PU bootlder ver.) • Read only	Bootloader version of the power unit.
0x2000:013 (P190.13)	Device data: PU bootloader type (Device data: PU bootlder type) • Read only	Bootloader type of the power unit.
0x2000:014 (P190.14)	Device data: Module - firmware version (Device data: Mod. firmware) • Read only	Firmware version of the plugged-in module (e. g. WLAN module).
0x2001 (P191.00)	Device name (Device name) [" My Device "]	Any device name (e.g. "Wheel drive") can be set in this object for the purpose of device identification.
0x2002:004 (P192.04)	Device module: CU type code (Device module: CU type code) • Read only	Type code of the control unit.
0x2002:005 (P192.05)	Device module: PU type code (Device module: PU type code) • Read only	Type code of the power unit.
0x2002:006 (P192.06)	Device module: CU serial number (Device module: CU serial number) • Read only	Serial number of the control unit.
0x2002:007 (P192.07)	Device module: PU serial number (Device module: PU serial number) • Read only	Serial number of the power unit.



5.2.11 Device overload monitoring (i*t)

The inverter calculates the i*t utilisation in order to protect itself against thermal overload. In simple terms: a higher current or an overcurrent that continues for a longer time causes a higher i*t utilisation.

⚠ DANGER!

Uncontrolled motor movements by pulse inhibit.

When the device overload monitoring function is activated, pulse inhibit is set and the motor becomes torqueless. A load that is connected to motors without a holding brake may therefore cause uncontrolled movements! Without a load, the motor will coast.

► Only operate the inverter under permissible load conditions.

Details

The device overload monitoring function primarily offers protection to the power section. Indirectly, also other components such as filter chokes, circuit-board conductors, and terminals are protected against overheating. Short-time overload currents followed by recovery periods (times of smaller current utilisation) are permissible. The monitoring function during operation checks whether these conditions are met, taking into consideration that higher switching frequencies and lower stator frequencies as well as higher DC voltages cause a greater device utilisation.

- If the device utilisation exceeds the warning threshold set in [0x2D40:002](#) (default setting: 95 %), the inverter outputs a warning.
- If the device utilisation exceeds the permanent error threshold 100 %, the inverter is disabled immediately and any further operation is stopped.

Device overload monitoring enables operation of the inverter under the following load conditions:

- Continuous current load with up to 100 % rated current.
- 3-minute cycle: 150 % rated current for 60 s, recovery phase 120 s with 75 % rated current.
- 15-second cycle: 200 % rated current for 3 s, recovery phase 12 s with 75 % rated current.

Parameter	Name / value range / [default setting]	Info
0x2D40:002	Device utilisation (i*t): Warning threshold 0 ... [95] ... 101 %	If the device utilisation exceeds the threshold set, the inverter outputs a warning. <ul style="list-style-type: none"> • With the setting 0 % or ≥ 100 %, the warning is deactivated.
0x2D40:004 (P135.04)	Device utilisation (i*t) (Device utilisat.: ixt utilisation) • Read only: x %	Display of the current device utilisation.
0x2D40:005 (P135.05)	Device utilisation (i*t): Error response (Device utilisat.: Error response)	Selection of the response to be executed when the device overload monitoring function is triggered. Associated error code: • 9090 0x2382 - I*t error
	2 Trouble 3 Fault	► Error types 113
0x2DDF:001	Axis information: Rated current • Read only: x.xx A	Display of the rated current of the axis.

5.2.12 Heatsink Temperature Monitoring

Parameter	Name / value range / [default setting]	Info
0x2D84:001 (P117.01)	Heatsink temperature (Heatsink temp.: Heatsink temp.) • Read only: x.x °C	Display of the current heatsink temperature.

Diagnostics and fault elimination

Diagnostics parameter

Life-diagnosis



Parameter	Name / value range / [default setting]	Info
0x2D84:002	Heatsink temperature: Warning threshold 50.0 ... [80.0]* ... 100.0 °C * Default setting depending on the size.	Warning threshold for temperature monitoring. <ul style="list-style-type: none"> • If the heatsink temperature exceeds the threshold set here, the inverter outputs a warning. • The warning is reset with a hysteresis of approx. 5 °C. • If the heatsink temperature increases further and exceeds the non-adjustable error threshold (100 °C), the inverter changes to the "Fault" device status. The inverter is disabled and thus any further operation is stopped.

5.2.13 Life-diagnosis

The following parameters provide some information about the use of the inverter.

This includes the following information:

- Operating and power-on time of the inverter/control unit
- Operating time of the internal fan
- Number of switching cycles of the mains voltage
- Number of switching cycles of the relay
- Number of short-circuits and earth faults that have occurred
- Display of the number of "Imax: Clamp responded too often" errors that have occurred.

Parameter	Name / value range / [default setting]	Info
0x2D81:001 (P151.01)	Life-diagnosis: Operating time (Life-diagnosis: Operating time) • Read only: x s	Display showing for how long the inverter has been running so far "Operation enabled" device state).
0x2D81:002 (P151.02)	Life-diagnosis: Power-on time (Life-diagnosis: Power-on time) • Read only: x s	Display showing for how long the inverter has been supplied with mains voltage so far.
0x2D81:003 (P151.03)	Life-diagnosis: Control unit operating time (Life-diagnosis: CU oper. time) • Read only: x ns	Display showing for how long the control unit has been supplied with voltage so far. This includes the external 24-V supply and voltage supply via USB module. • This also includes the time within which the control unit has only been supplied with an external 24 V voltage.
0x2D81:004 (P151.04)	Life-diagnosis: Main switching cycles (Life-diagnosis: Switching cycles) • Read only	Display of the number of switching cycles of the mains voltage.
0x2D81:005 (P151.05)	Life-diagnosis: Relay switching cycles (Life-diagnosis: Relay cycles) • Read only	Display of the number of switching cycles of the relay.
0x2D81:006 (P151.06)	Life-diagnosis: Short-circuit counter (Life-diagnosis: Short-circ.count) • Read only	Display of the number of short circuits that have occurred.
0x2D81:007 (P151.07)	Life-diagnosis: Earth fault counter (Life-diagnosis: Earthfault count) • Read only	Display of the number of earth faults that have occurred.
0x2D81:008 (P151.08)	Life-diagnosis: Clamp active (Life-diagnosis: Clamp active) • Read only	Display of the number of "Imax: Clamp responded too often" errors that have occurred. • "Clamp" = short-time inhibit of the inverter in V/f operation when the current limit shown in 0x2DDF:002 is reached.
0x2D81:009 (P151.09)	Life-diagnosis: Fan operating time (Life-diagnosis: Fan oper. time) • Read only: x s	Display showing for how long the internal fan has been running so far.



5.3 Error handling

Many functions integrated in the inverter can

- detect errors and thus protect inverter and motor from damages,
- detect an operating error of the user,
- output a warning or information if desired.

5.3.1 Error types

In the event of an error, the inverter response is determined by the error type defined for the error.

In the following, the different error types are described.

Error type "No response"

The error is completely ignored (does not affect the running process).

Error type "Warning"

A warning does not severely affect the process and may be also ignored in consideration of safety aspects.

Error type "Fault"

The motor is brought to a standstill with the quick stop ramp.

- The inverter will only be disabled after the quick stop is executed (motor at standstill) or after the time-out time set in [0x2826](#) has been elapsed. ▶ [Timeout für fault reaction](#) [440](#)
- **Exception:** In case of a serious fault, the inverter is disabled immediately. The motor becomes torqueless (coasts). For details see the table "[Error codes](#)". [607](#)

Error type "Trouble"

Just like "Fault", but the error state will be left automatically if the error condition is not active anymore.



- **Exception:** In case of a severe trouble, the inverter is disabled immediately. The motor becomes torqueless (coasts). For details see the table "[Error codes](#)". [607](#)
- The restart behaviour after trouble can be configured. ▶ [Automatic restart](#) [441](#)



In the operating mode [0x6060 \(P301.00\)](#) = "CiA: Velocity mode [2]", the behaviour in case of "Trouble" is just like in case of "Fault"!

Comparison of the error types

The following table compares the main differences of the error types:

Error type	Logging in the Error history buffer / Logbook	Display in the CiA 402 status word 0x6041 (P780.00)	Inverter disable	Motor stop	Error reset is required	"ERR" LED (red)
No response	No	No	No	No	No	off
Warning	Yes	yes, bit 7	No	No	No	 blinking fast (4 Hz)
Trouble	Yes	yes, bit 3	after quick stop or immediately.	quick stop ramp or coasting.	No	 blinking (1 Hz)
Error	Yes	yes, bit 3	For details see table " Error codes ". 607		Yes	 on

Diagnostics and fault elimination

Error handling
Error configuration

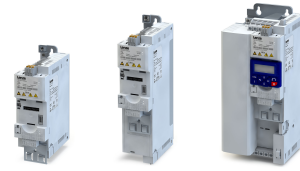

5.3.2 Error configuration

The errors can be divided into two types:

- Errors with predefined error type
- Errors with configurable error type

Especially critical errors are permanently set to the "Fault" error type in order to protect inverter and motor from damages.

In case of errors with configurable error type, the default setting can be changed in consideration of safety aspects and the operational performance. The selection "No response [0]" is, however, only available for minor errors.

The "Error codes" table lists the error type for each error. If the error type can be configured by the user, the "adjustable in" column displays the corresponding parameter. [607](#)

5.3.3 Error reset

If the error condition is not active anymore, there are several options to reset an active error and thus leave the error state again:

- Via the keypad key . ▶ [Error reset with keypad 602](#)
- Via the trigger assigned to the "Reset fault" function. ▶ [Reset error 541](#)
- Via the button in the »EASY Starter« ("Diagnostics" tab).
- In the default setting of [0x400E:008 \(P505.08\)](#) via bit 7 in the mappable data word Net-WordIN1 [0x4008:001 \(P590.01\)](#).
- Via bit 7 in the mappable CiA 402 control word [0x6040](#).
- Via bit 2 in the mappable AC Drive control word [0x400B:001 \(P592.01\)](#).
- Via bit 11 in the mappable LECOM control word [0x400B:002 \(P592.02\)](#).

Notes:

- Certain errors can only be reset by mains switching.
- Certain errors (e. g. earth fault or short circuit of the motor phases) may cause a blocking time. In this case, the error can be reset only after the blocking time has elapsed. An active blocking time is displayed via bit 14 in the inverter status word [0x2831](#).

The "Error codes" table gives the blocking time (if available) for each error. This table also shows whether mains switching is required for the error reset. [607](#)

5.3.4 Keypad error messages

If an error is pending, the keypad shows the following information:

Keypad display	Meaning
	① Error text ② Error type: F Fault T Trouble W Warning ③ Error code (hexadecimal) ▶ Error codes 607 ▶ Error reset with keypad 602
	After a disturbance, a restart is possible if the error condition is not active anymore. The keypad shows this by the "Restart Pending" note. The note is displayed in a 1-second interval alternating with the error text. ▶ Timeout für fault reaction 440



5.4 Data handling

In the following, the behaviour of the inverter is described if the data on the memory module do not match the inverter hardware or firmware, for whatever reason.

The following points are described in detail here:

- Automatic loading of the parameter settings when the inverter is switched on
- Manual loading of the user data via device command
- Manual loading of the OEM data via device command
- Manual saving of the parameter settings via device command
- Hardware and firmware updates/downgrades

Automatic loading of the parameter settings when the inverter is switched on

Process when the inverter is switched on:

1. The default setting saved in the inverter firmware is loaded.
2. If a memory module with valid data is available, the data is loaded from the user memory.

Otherwise a corresponding error message is output:

Error message	Info
0x7681: Memory module not present	The default setting saved in the inverter firmware is loaded. The error cannot be reset by the user. Remedy: 1. Switch off inverter. 2. Plug the memory module into the inverter. 3. Switch the inverter on again.
0x7682: Memory module invalid user data	The user parameter settings are invalid both in the user memory and in the backup. Thus, the user parameter settings are lost. The default setting is loaded automatically. Remedy: 1. Execute user parameter settings again. 2. Execute device command "Save user data" 0x2022:003 (P700.03) .
0x7684: Data not compl. saved before powerdown	Saving the parameter settings was interrupted by an unexpected disconnection. The user parameter settings were not saved completely. When the inverter is switched on the next time, the backup data is copied to the user memory. Remedy: 1. Check user parameter settings. (The loaded backup is an older version.) 2. If required, repeat the changes made last. 3. Execute device command "Save user data" 0x2022:003 (P700.03) .
0x7689: Memory module: invalid OEM data	The OEM memory contains invalid parameter settings or is empty. The user parameter settings are loaded automatically. Remedy: • Execute device command "Save OEM data" 0x2022:006 (P700.06) . • Thus, the user parameter settings get lost!

Notes:

- If the memory module contains invalid data, the device commands "Load user data" [0x2022:004 \(P700.04\)](#) and "Load OEM data" [0x2022:005 \(P700.05\)](#) are not executed. The status feedback "Action cancelled" takes place.
- If the memory module is empty, the default setting saved in the inverter firmware is loaded. No access is required by the user. The memory module remains empty until the device command "Save user data" [0x2022:003 \(P700.03\)](#) or "Save OEM data" [0x2022:006 \(P700.06\)](#) is executed.
- Irrespective of the data on the memory module, the device command "Load default settings" [0x2022:001 \(P700.01\)](#) is always enabled.

Manual loading of the user data via device command

Device command: "Load user data" [0x2022:004 \(P700.04\)](#)

- If the user memory contains invalid parameter settings, the default setting saved in the inverter firmware is automatically loaded.
- For possible error messages, see the table above.

Diagnostics and fault elimination

Data handling

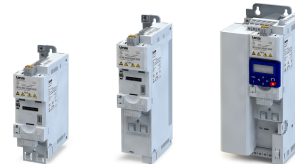

Manual loading of the OEM data via device command

Device command: "Load OEM data" [0x2022:005 \(P700.05\)](#)

- If the OEM memory contains invalid parameter settings, the user parameter settings are loaded automatically.
- If the OEM memory is empty, the status feedback "Action cancelled" takes place. The current parameter settings remain unchanged.

Manual saving of the parameter settings via device command

Device command: "Save user data" [0x2022:003 \(P700.03\)](#)

- It may happen that the parameter settings cannot be saved because the user memory is full. In this case, the following error message appears:

Error message	Infot
0x7680 : Memory module is full	The memory module contains too many parameter settings. The inverter copies the current backup to the user memory without overwriting the data in the RAM. Remedy: Execute device command "Save user data" 0x2022:003 (P700.03) again. This reinitialises the user memory with the current parameter settings. By this means, parameter settings no longer required are deleted automatically.



Hardware and firmware upgrades/downgrades

By "taking along" the memory module, all parameter settings of a device can be transferred to another device, for instance, in case of a device replacement. When switched on, the inverter checks whether the parameter settings saved in the memory module match the inverter hardware and firmware. In case of an incompatibility, a corresponding error message is output.

The following table contains details on different scenarios:

Prio	Compatibility check User data ↔ device	Error message	Info
1	Device has a newer firmware Example: Version 2.x → version 3.x	-	The "firmware upgrade" is recognised. <ul style="list-style-type: none"> The user parameter settings are loaded without an action being required by the user. If the parameter settings are saved afterwards, the user memory is reinitialised with the current parameter settings. By this means, parameter settings no longer required are deleted automatically.
	Device has an older firmware Example: Version 4.x → version 3.x	0x7690: EPM firmware version incompatible	The data is loaded into the RAM memory but are incompatible. Remedy:
2	Firmware type is different	0x7691: EPM data: firmware type incompatible	<ol style="list-style-type: none"> Execute device command "Load default settings" 0x2022:001 (P700.01). Execute device command "Save user data" 0x2022:003 (P700.03) or "Save OEM data" 0x2022:006 (P700.06) in order that the error does not occur at the next switch-on.
	Power unit is different (and incompatible with saved data)	0x7693: EPM data: PU size incompatible	
	Country code is different Example: EU → USA	0x7691: EPM data: firmware type incompatible	
	Device has less functionality Examples: i550 → i510 Application I/O → Standard I/O	0x7691: EPM data: firmware type incompatible	
3	Network option is different Example: CANopen → PROFIBUS	0x7692: EPM data: new firmware type detected	The data is loaded into the RAM memory and is compatible. However, the settings must be accepted by the user: <ol style="list-style-type: none"> Reset error. Execute device command "Save user data" 0x2022:003 (P700.03) or "Save OEM data" 0x2022:006 (P700.06) in order that the error does not occur at the next switch-on. Alternatively, the default setting can be loaded and then saved.
4	Device has more functionality Examples: i510 → i550 Standard I/O → application I/O	-	The "hardware upgrade" is recognised. <ul style="list-style-type: none"> The user parameter settings are loaded without an action being required by the user. If the parameter settings are saved afterwards, the user memory is reinitialised with the current parameter settings. By this means, parameter settings no longer required are deleted automatically.
5	Power unit is different (but compatible with saved data) Example: 230 V/0.75 kW → 400 V/5.5 kW	0x7694: EPM data: new PU size detected	The data is loaded into the RAM memory and is compatible. However, the settings must be accepted by the user: <ol style="list-style-type: none"> Reset error. Execute device command "Save user data" 0x2022:003 (P700.03) or "Save OEM data" 0x2022:006 (P700.06) in order that the error does not occur at the next switch-on. Alternatively, the default setting can be loaded and then saved.

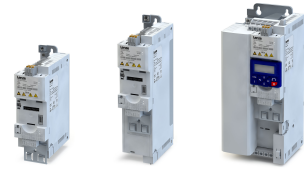

6 Basic setting

This chapter contains the most frequently used functions and settings to adapt the inverter to a simple application based on the default setting.

- [Mains voltage](#) 119
- [Control source selection](#) 121
- [Selection of setpoint source](#) 122
- [Starting/stopping performance](#) 126
- [Frequency limits and ramp times](#) 129
- [Quick stop](#) 132
- [S-shaped ramps](#) 134
- [Optical device identification](#) 135



6.1 Mains voltage

The rated mains voltage set for the inverter has an impact on the operating range of the inverter.

Details

By default, the rated mains voltage in [0x2540:001 \(P208.01\)](#) is set according to the product code of the inverter.



Check the setting of the rated mains voltage in [0x2540:001 \(P208.01\)](#). Ensure that it matches the actual mains voltage applied!

Region	inverter	Product code 0x2000:001 (P190.01)	Rated mains voltage	
			Default setting	Possible settings
EU	i500, 230 V, 1-phase	i5xAExxxBxxxx0xxxx	230 Veff [0]	230 Veff [0]
us	i500, 230 V, 1-phase	i5xAExxxBxxxx1xxxx	230 Veff [0]	230 Veff [0]
EU	i500, 230 V, 1/3-phase	i5xAExxxDxxxx0xxxx	230 Veff [0]	230 Veff [0]
US	i500, 230 V, 1/3-phase	i5xAExxxDxxxx1xxxx	230 Veff [0]	230 Veff [0]
EU	i500, 400 V, 3-phase	i5xAExxxFxxxx0xxxx	400 Veff [1]	400 Veff [1], 480 Veff [2]
US	i500, 480 V, 3-phase	i5xAExxxFxxxx1xxxx	480 Veff [2]	400 Veff [1], 480 Veff [2]

Notes regarding the table:

- The inverter types 400/480 V can be used with different mains voltages. For setting the internal limit values, the rated mains voltage can be set in [0x2540:001 \(P208.01\)](#) by the user.
- If the inverter is reset to the delivery status, the rated mains voltage is also reset to the default setting listed in the table according to the product code.

The following results from the rated mains voltage set:

- the error threshold for monitoring the DC-bus voltage and
- the voltage threshold for braking operation ("brake chopper threshold").

Monitoring of the DC-bus voltage

- The warning thresholds for monitoring are adjustable.
- The error thresholds and reset thresholds for monitoring result from the rated mains voltage set:

Rated mains voltage	Undervoltage thresholds			Overvoltage thresholds		
	Warning threshold	Error threshold	Reset threshold	Warning threshold	Error threshold	Reset threshold
Setting in 0x2540:001 (P208.01)	Setting in 0x2540:002 (P208.02)	Display in 0x2540:003 (P208.03)	Display in 0x2540:004 (P208.04)	Setting in 0x2540:005 (P208.05)	Display in 0x2540:006 (P208.06)	Display in 0x2540:007 (P208.07)

- If the DC-bus voltage of the inverter falls below the undervoltage error threshold, the "Trouble" response is triggered.
 - Without external 24-V supply: Motor behaves according to [0x2838:002 \(P203.02\)](#).
 - With external 24-V supply: At undervoltage, motor behaves according to disturbance response.
- If the DC-bus voltage of the inverter exceeds the overvoltage error threshold, the "Fault" response is triggered.



The motor does not restart automatically after the overvoltage monitoring function has been activated.

Basic setting

Mains voltage

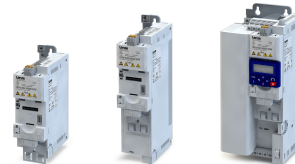

Parameter	Name / value range / [default setting]	Info
0x2540:001 (P208.01)	Mains settings: Rated mains voltage (Mains settings: Mains voltage) • Setting can only be changed if the inverter is inhibited.	Selection of the mains voltage for actuating the inverter.
	0 230 V _{eff}	
	1 400 V _{eff}	
	2 480 V _{eff}	
	10 230 V _{eff} /reduced LU level	
0x2540:002 (P208.02)	Mains settings: Undervoltage warning threshold (Mains settings: LU warn. thresh.) 0 ... [0]* ... 800 V * Default setting depending on the size.	Setting of the warning threshold for monitoring DC bus undervoltage. • If the DC bus voltage falls below the threshold set, the inverter outputs a warning. • The warning is reset with a hysteresis of 10 V.
0x2540:003 (P208.03)	Mains settings: Undervoltage error threshold (Mains settings: LU error thresh.) • Read only: x V	Display of the fixed error threshold for monitoring DC bus undervoltage. • If the DC-bus voltage falls below the threshold displayed, the "Fault" response is triggered.
0x2540:004 (P208.04)	Mains settings: Undervoltage reset threshold (Mains settings: LU reset thresh.) • Read only: x V	Display of the fixed reset threshold for monitoring DC bus undervoltage.
0x2540:005 (P208.05)	Mains settings: Overvoltage warning threshold (Mains settings: OU warn. thresh.) 0 ... [0]* ... 800 V * Default setting depending on the size.	Setting of the warning threshold for monitoring DC bus overvoltage. • If the DC bus voltage exceeds the threshold set, the inverter outputs a warning. • The warning is reset with a hysteresis of 10 V.
0x2540:006 (P208.06)	Mains settings: Overvoltage error threshold (Mains settings: OU error thresh.) • Read only: x V	Display of the fixed error threshold for monitoring the DC bus overvoltage. • If the DC-bus voltage exceeds the threshold displayed, the "Fault" response is triggered.
0x2540:007 (P208.07)	Mains settings: Overvoltage reset threshold (Mains settings: OU reset thresh.) • Read only: x V	Display of the fixed reset threshold for monitoring DC bus overvoltage.



6.2 Control source selection

The selected "control source" serves to provide the inverter with its start, stop, and reversal commands.

Possible control sources are:

- Digital inputs
- Keypad
- Network





Irrespective of the control source selection, stop commands are always active from each source connected! If, for instance, the network control is active and a keypad is connected for diagnostic purposes, the motor is also stopped if the keypad key  is pressed.

Exception: In the jog operation, a stop command has no impact.

Details

- The default setting "Flexible I/O configuration [0]" in [0x2824 \(P200.00\)](#) enables a flexible control of the inverter via digital inputs, network and keypad. The control of the inverter via the digital inputs is preconfigured. For details see the chapter "[Function assignment of the inputs and outputs](#)". [📖 52](#)
- If the keypad is to be used as the sole control source for the application, selection "Keypad [1]" is to be set in [0x2824 \(P200.00\)](#).
- The control source that is currently active is displayed in [0x282B:001 \(P125.01\)](#).

Parameter	Name / value range / [default setting]	Info
0x2824 (P200.00)	Control selection (Control select.)	Selection of the type of inverter control.
	0 Flexible I/O configuration	This selection enables a flexible assignment of the start, stop, and rotating direction commands with digital signal sources. <ul style="list-style-type: none"> • Digital signal sources can be digital inputs, network and keypad. • The I/O configuration is made via the parameters 0x2631:xx (P400.xx).
	1 Keypad	This selection enables the motor to be started exclusively via the start key of the keypad. Other signal sources for starting the motor are ignored. <p> Start motor  Stop motor</p> <p>Note!</p> <ul style="list-style-type: none"> • The functions "Enable inverter" 0x2631:001 (P400.01) and "Run" 0x2631:002 (P400.02) must be set to TRUE to start the motor. • If jog operation is active, the motor cannot be stopped via the  keypad key.
0x282B:001 (P125.01)	Inverter diagnostics: Active control source (Inverter diag.: Active control)	Display of the control source that is currently active.
	• Read only	
	0 Flexible I/O configuration	
	1 Network	
	2 Keypad	
8 Keypad full control		

Related topics

- The preset I/O configuration can be individually adapted to the respective application. For details see the chapter "[Flexible I/O configuration](#)". [📖 493](#)
- For details of the network control of the inverter, see the chapter "[General network settings](#)". [📖 200](#)

Basic setting

Selection of setpoint source

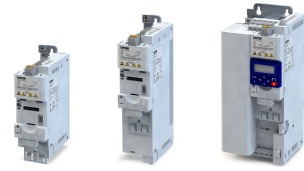

6.3 Selection of setpoint source

The selected "setpoint source" serves to provide the inverter with its setpoint. The setpoint source can be selected individually for each operating mode.

Possible setpoint sources are:

- Analog inputs
- Keypad
- Network
- Parameterisable setpoints (presets)
- Digital inputs (configured as HTL input for pulse train or HTL encoder)
- "Motor potentiometer" function
- "Sequencer" function

Details

- For applications only requiring one setpoint it is sufficient to define the standard setpoint source in the following parameters.
- For applications requiring a change-over of the setpoint source during operation, the functions for setpoint change-over have to be configured accordingly. ▶ [Setpoint change-over](#)

 514



Parameter	Name / value range / [default setting]	Info
0x2860:001 (P201.01)	Frequency control: Default setpoint source (Std. setpoints: Freq. setp. src.)	Selection of the standard setpoint source for operating mode "MS: Velocity mode". <ul style="list-style-type: none"> The selected standard setpoint source is always active in the operating mode 0x6060 (P301.00) = "MS: Velocity mode [-2]" when no setpoint change-over to another setpoint source via corresponding triggers/functions is active. ▶ Setpoint change-over 514
1	Keypad	The setpoint is specified locally by the keypad. <ul style="list-style-type: none"> Default setting: 0x2601:001 (P202.01) Use the ↑ and ↓ navigation keys to change the keypad setpoint (also during running operation).
2	Analog input 1	The setpoint is defined as analog signal via the analog input 1. ▶ Analog input 1 568
3	Analog input 2	The setpoint is defined as analog signal via the analog input 2. ▶ Analog input 2 572
4	HTL input (from version 04.00)	The digital inputs DI3 and DI4 can be configured as HTL input to use an HTL encoder as setpoint encoder or define the setpoint as a reference frequency ("pulse train"). ▶ HTL input setpoint source 534
5	Network	The setpoint is defined as process data object via the network. ▶ Configuring the network 199
11	Frequency preset 1	For the setpoint selection, preset values can be parameterised and selected. ▶ Setpoint source of preset setpoints 522
12	Frequency preset 2	
13	Frequency preset 3	
14	Frequency preset 4	
15	Frequency preset 5	
16	Frequency preset 6	
17	Frequency preset 7	
18	Frequency preset 8	
19	Frequency preset 9	
20	Frequency preset 10	
21	Frequency preset 11	
22	Frequency preset 12	
23	Frequency preset 13	
24	Frequency preset 14	
25	Frequency preset 15	
31	Segment preset 1 (from version 03.00)	For the setpoint selection, the segment presets parameterised for the "sequencer" function can be selected as well. ▶ Sequencer 462
32	Segment preset 2 (from version 03.00)	
33	Segment preset 3 (from version 03.00)	
34	Segment preset 4 (from version 03.00)	
35	Segment preset 5 (from version 03.00)	
36	Segment preset 6 (from version 03.00)	
37	Segment preset 7 (from version 03.00)	
38	Segment preset 8 (from version 03.00)	
50	Motor potentiometer	The setpoint is generated by the "motor potentiometer" function. This function can be used as an alternative setpoint control which is controlled via two signals: "MOP setpoint up" and "MOP setpoint down". ▶ Motor potentiometer setpoint source (MOP) 528

Basic setting

Selection of setpoint source



Parameter	Name / value range / [default setting]	Info
0x2860:002 (P201.02)	PID control: Default setpoint source (Stnd. setpoints: PID setp. src.)	Selection of the standard setpoint source for the reference value of the PID control. <ul style="list-style-type: none"> The selected standard setpoint source is always active with an activated PID control when no setpoint change-over to another setpoint source via corresponding triggers/functions is active.
	1 Keypad	The setpoint is specified locally by the keypad. <ul style="list-style-type: none"> Default setting: 0x2601:002 (P202.02) Use the ↑ and ↓ navigation keys to change the keypad setpoint (also during running operation).
	2 Analog input 1	The setpoint is defined as analog signal via the analog input 1. ▶ Analog input 1 📄 568
	3 Analog input 2	The setpoint is defined as analog signal via the analog input 2. ▶ Analog input 2 📄 572
	4 HTL input (from version 04.00)	The digital inputs DI3 and DI4 can be configured as HTL input to use an HTL encoder as setpoint encoder or define the setpoint as a reference frequency ("pulse train"). ▶ HTL input setpoint source 📄 534
	5 Network	The setpoint is defined as process data object via the network. ▶ Configuring the network 📄 199
	11 PID preset 1	For the setpoint selection, preset values can be parameterised and selected. ▶ Setpoint source of preset setpoints 📄 522
	12 PID preset 2	
	13 PID preset 3	
	14 PID preset 4	
	15 PID preset 5	
	16 PID preset 6	
	17 PID preset 7	
	18 PID preset 8	
	31 Segment preset 1 (from version 03.00)	For the setpoint selection, the segment presets parameterised for the "sequencer" function can be selected as well. ▶ Sequencer 📄 462
	32 Segment preset 2 (from version 03.00)	
	33 Segment preset 3 (from version 03.00)	
	34 Segment preset 4 (from version 03.00)	
	35 Segment preset 5 (from version 03.00)	
	36 Segment preset 6 (from version 03.00)	
37 Segment preset 7 (from version 03.00)		
38 Segment preset 8 (from version 03.00)		
50 Motor potentiometer	The setpoint is generated by the "motor potentiometer" function. This function can be used as an alternative setpoint control which is controlled via two signals: "MOP setpoint up" and "MOP setpoint down". ▶ Motor potentiometer setpoint source (MOP) 📄 528	



Basic setting

Selection of setpoint source

Keypad setpoint default setting

Parameter	Name / value range / [default setting]	Info
0x2860:003 (P201.03)	Torque control: Default setpoint source (Std. setpoints: Torque setp.src.) <ul style="list-style-type: none"> From version 03.00 	Selection of the standard setpoint source for operating mode "MS: Torque mode". <ul style="list-style-type: none"> The selected standard setpoint source is always active in the operating mode 0x6060 (P301.00) = "MS: Torque mode [-1]" when no setpoint change-over to another setpoint source via corresponding triggers/functions is active.
1	Keypad	The setpoint is specified locally by the keypad. <ul style="list-style-type: none"> Default setting: 0x2601:003 (P202.03) Use the ↑ and ↓ navigation keys to change the keypad setpoint (also during running operation).
2	Analog input 1	The setpoint is defined as analog signal via the analog input 1. <ul style="list-style-type: none"> Analog input 1 □ 568
3	Analog input 2	The setpoint is defined as analog signal via the analog input 2. <ul style="list-style-type: none"> Analog input 2 □ 572
4	HTL input (from version 04.00)	The digital inputs DI3 and DI4 can be configured as HTL input to use an HTL encoder as setpoint encoder or define the setpoint as a reference frequency ("pulse train"). <ul style="list-style-type: none"> HTL input setpoint source □ 534
5	Network	The setpoint is defined as process data object via the network. <ul style="list-style-type: none"> Configuring the network □ 199
11	Torque preset 1	For the setpoint selection, preset values can be parameterised and selected. <ul style="list-style-type: none"> Setpoint source of preset setpoints □ 522
12	Torque preset 2	
13	Torque preset 3	
14	Torque preset 4	
15	Torque preset 5	
16	Torque preset 6	
17	Torque preset 7	
18	Torque preset 8	
31	Segment preset 1	For the setpoint selection, the segment presets parameterised for the "sequencer" function can be selected as well. <ul style="list-style-type: none"> Sequencer □ 462
32	Segment preset 2	
33	Segment preset 3	
34	Segment preset 4	
35	Segment preset 5	
36	Segment preset 6	
37	Segment preset 7	
38	Segment preset 8	
50	Motor potentiometer	The setpoint is generated by the "motor potentiometer" function. This function can be used as an alternative setpoint control which is controlled via two signals: "MOP setpoint up" and "MOP setpoint down". <ul style="list-style-type: none"> Motor potentiometer setpoint source (MOP) □ 528

6.3.1 Keypad setpoint default setting

For the manual setpoint selection via keypad the following default settings are used.

Parameter	Name / value range / [default setting]	Info
0x2601:001 (P202.01)	Keypad setpoints: Frequency setpoint (Keypad setpoints: KP freq.setpoint) 0.0 ... [20.0] ... 599.0 Hz	Default setting of the keypad setpoint for the operating mode 0x6060 (P301.00) = "MS: Velocity mode [-2]".
0x2601:002 (P202.02)	Keypad setpoints: Process controller setpoint (Keypad setpoints: KP PID setpoint) -300.00 ... [0.00] ... 300.00 PID unit	Default setting of the keypad setpoint for the reference value of the PID control.
0x2601:003 (P202.03)	Keypad setpoints: Torque setpoint (Keypad setpoints: KP torq.setpoint) -400.0 ... [100.0] ... 400.0 % <ul style="list-style-type: none"> From version 03.00 	Default setting of the keypad setpoint for the operating mode 0x6060 (P301.00) = "MS: Torque mode [-1]". <ul style="list-style-type: none"> 100 % ≙ Motor rated torque 0x6076 (P325.00)

The increment for keypad setpoints can be adapted in [0x2862 \(P701.00\)](#) by pressing a keypad arrow key once.

Basic setting

Starting/stopping performance
Starting performance



6.4 Starting/stopping performance

6.4.1 Starting performance

The start can be optionally made with DC braking or flying restart circuit. Moreover, an automatic start can be activated after switch-on.

Details

The start method can be selected in `0x2838:001 (P203.01)`. The following diagram demonstrates the different start methods:

Input signals

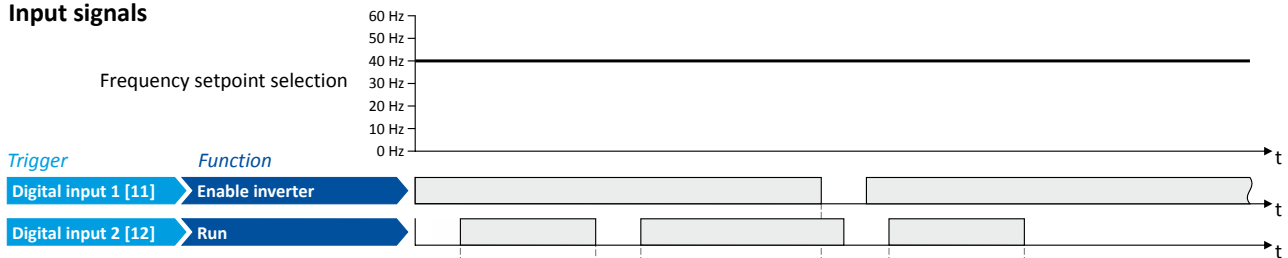

Output signals

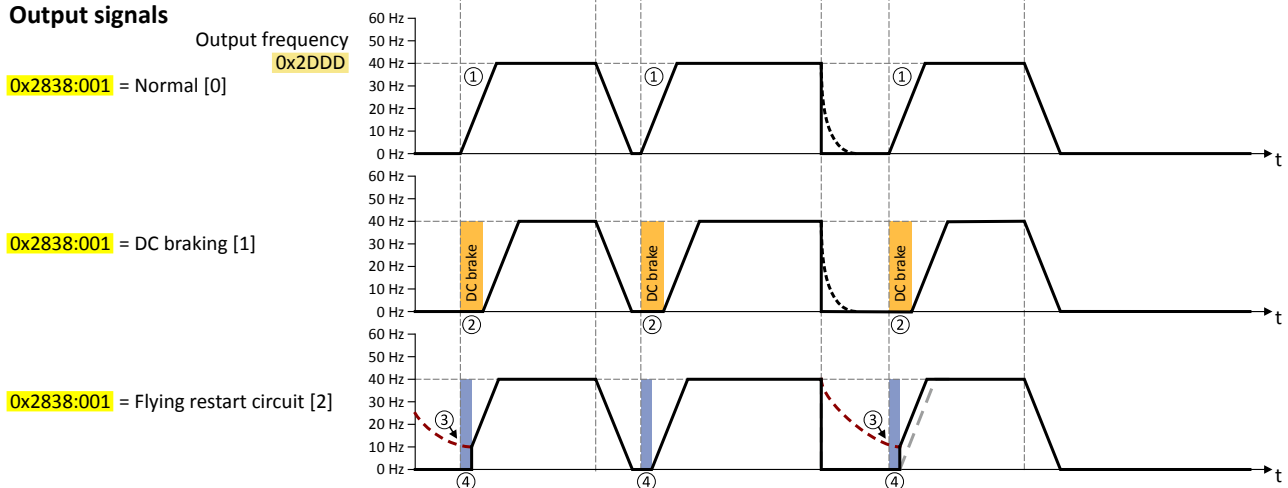

- ① Start method = "Normal [0]": After the start command, the motor is accelerated to the setpoint with the set acceleration time.
- ② Start method = "DC braking [1]": After the start command, the "DC braking" function is active. Only after the hold time set in `0x2B84:002 (P704.02)` has elapsed, the motor is accelerated to the setpoint with the set acceleration time.
▶ [DC braking](#) □ 386
- ③ For demonstrating the flying restart circuit: At the time of the start command, the motor is not at standstill (for instance by loads with high inertia such as fans or flywheels).
- ④ Start method = "Flying restart circuit [2]": After the start command, the flying restart circuit is active. The flying restart circuit serves to restart a coasting motor on the fly during operation without speed feedback. The synchronicity between inverter and motor is coordinated so that the transition to the rotating motor is effected without jerk at the time of connection.
▶ [Flying restart circuit](#) □ 438

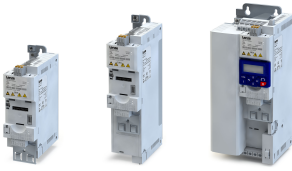

Automatic start after switching on the mains voltage

The automatic start can be activated in [0x2838:002 \(P203.02\)](#).

Preconditions for the automatic start:

- Flexible I/O configuration is selected: [0x2824 \(P200.00\)](#) = "Flexible I/O configuration [0]"
- For the start command, a digital input has been configured. (In case of keypad or activated network control, an automatic start is not possible.)

The following diagram demonstrates the function:

Input signals

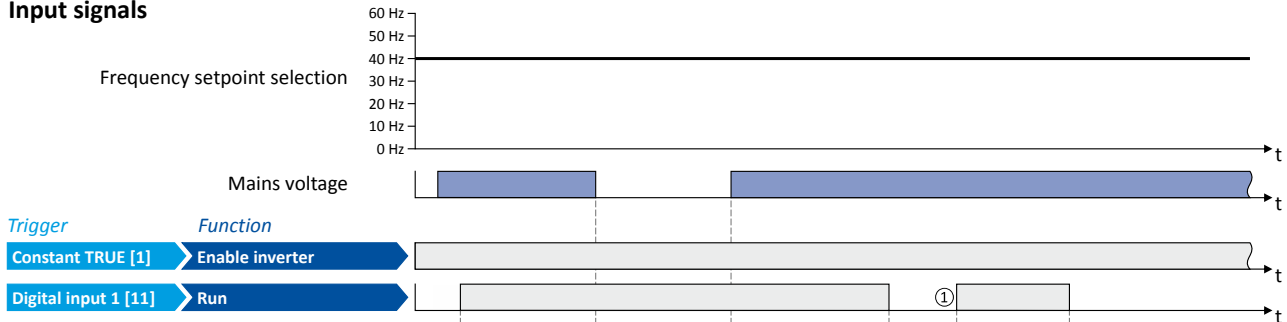

Output signals

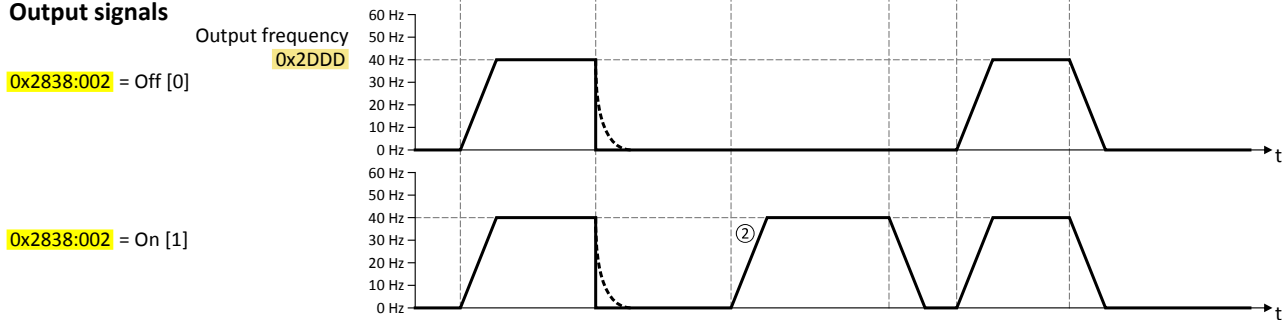

- ① Start at power-up = "Off [0]": After switching on the mains voltage, a renewed start command is required to start the motor.
- ② Start at power-up = "On [1]": After switching on the mains voltage, the motor starts automatically if a start command is active.

Parameter	Name / value range / [default setting]	Info
0x2838:001 (P203.01)	Start/stop configuration: Start method (Start/stop cfg: Start method)	Behaviour after start command.
	0 Normal	After start command, the standard ramps are active. <ul style="list-style-type: none"> • Acceleration time 1 can be set in 0x2917 (P220.00). • Deceleration time 1 can be set in 0x2918 (P221.00).
	1 DC braking	After start command, the "DC braking" function is active for the time set in 0x2B84:002 (P704.02) . ▶ DC braking □ 386
	2 Flying restart circuit	After the start command, the flying restart circuit is active. The flying restart function makes it possible to restart a coasting motor during operation without speed feedback. Synchronicity between the inverter and motor is coordinated so that the transition to the rotating motor is effected without jerk at the time of connection. ▶ Flying restart circuit □ 438
0x2838:002 (P203.02)	Start/stop configuration: Start at power-up (Start/stop cfg: Start at powerup)	Starting performance after switching on the mains voltage.
	0 Off	No automatic start after switching on mains voltage. In addition to the inverter enable, a renewed start command is always required to start the motor.
	1 On	Automatic start of the motor after switching on the mains voltage if the inverter is enabled and a start command exists.

Basic setting

Starting/stopping performance
Stopping performance

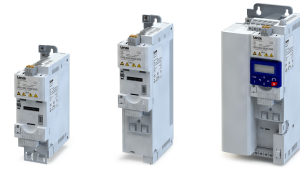

6.4.2 Stopping performance

In the default setting, the motor is brought to a standstill after a stop command with standard ramp. Alternatively, coasting or ramping down with quick stop ramp can be selected.

Details

The stop method can be selected in **0x2838:003 (P203.03)**. The following diagram demonstrates the different stop methods:

Input signals

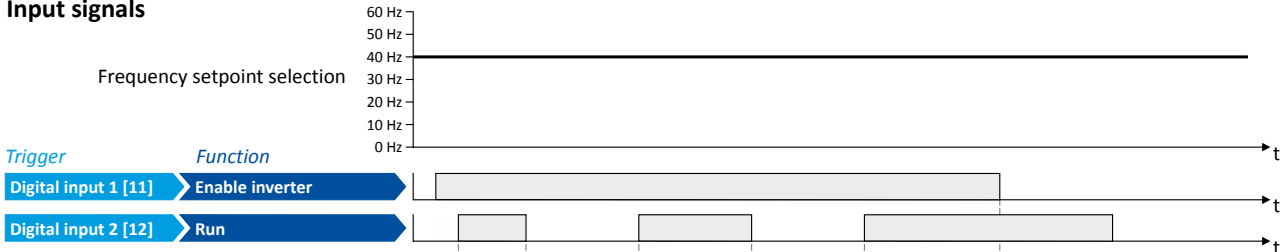

Output signals

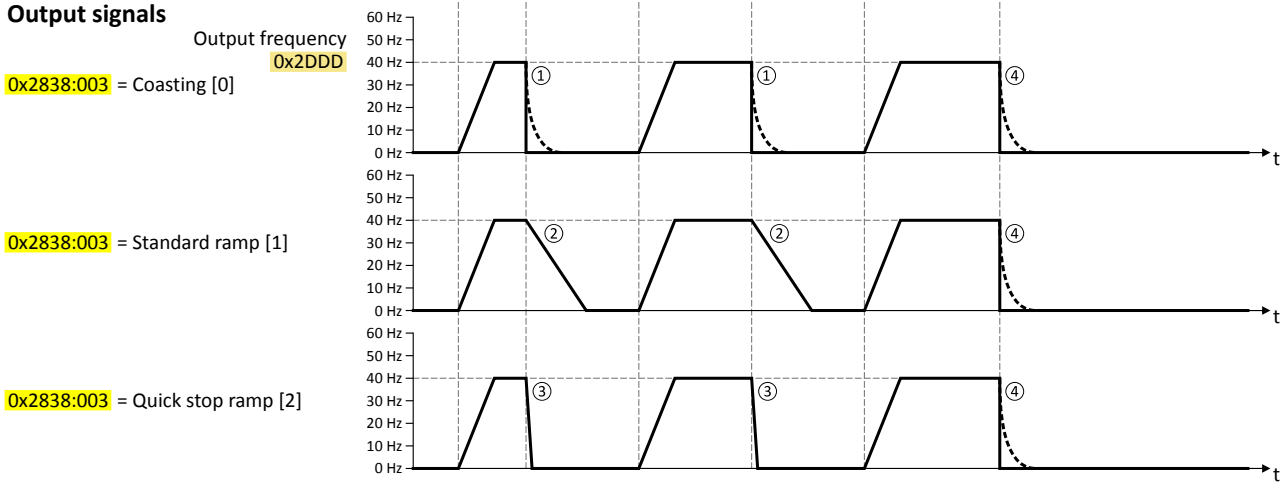

- ① Stop method = "Coasting [0]": The motor is coasting.
- ② Stop method = "Standard ramp [1]": The motor is brought to standstill with a deceleration time 1 (here: 10 s).
- ③ Stop method = "Quick stop ramp [2]": The motor is brought to a standstill with the deceleration time for quick stop (here: 1 s).
- ④ If "Enable inverter" is set to FALSE, the inverter is disabled. The motor becomes torqueless and coasts to standstill depending on the mass inertia of the machine (irrespective of the set stop method).

Parameter	Name / value range / [default setting]	Info
0x2838:003 (P203.03)	Start/stop configuration: Stop method (Start/stop cfg: Stop method)	Behaviour after the "Stop" command.
	0 Coasting	The motor becomes torqueless (coasts down to standstill).
	1 Standard ramp	The motor is brought to a standstill with deceleration time 1 (or deceleration time 2, if activated). <ul style="list-style-type: none"> • Deceleration time 1 can be set in 0x2918 (P221.00). • Deceleration time 2 can be set in 0x291A (P223.00). ▶ Frequency limits and ramp times □ 129
2 Quick stop ramp	The motor is brought to a standstill with the deceleration time set for the "Quick stop" function. <ul style="list-style-type: none"> • Deceleration time for quick stop can be set in 0x291C (P225.00). • The "quick stop" function can also be activated manually, for instance via a digital input. ▶ Quick stop □ 132 	



6.5 Frequency limits and ramp times

The frequency range can be limited by setting a minimum and maximum frequency. For the frequency setpoint, two different ramps can be parameterised. Change-over to ramp 2 can be carried out manually or automatically.

Details

The frequency setpoint is internally led via a ramp generator.

- The acceleration time set in **0x2917 (P220.00)** refers to an acceleration from standstill to the maximum frequency set in **0x2916 (P211.00)**. At a low setpoint selection, the real acceleration time decreases accordingly.
- The deceleration time set in **0x2918 (P221.00)** refers to the deceleration of the set maximum frequency to standstill. In case of a lower actual frequency, the actual deceleration time is reduced accordingly.

Input signals

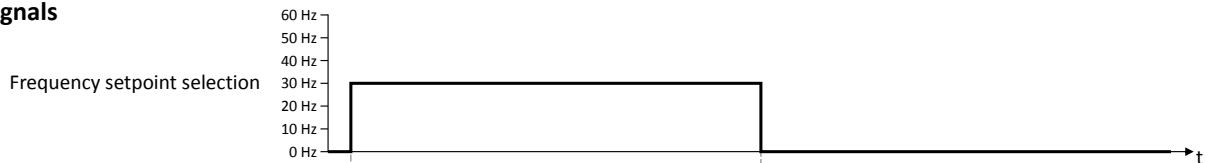

Output signals

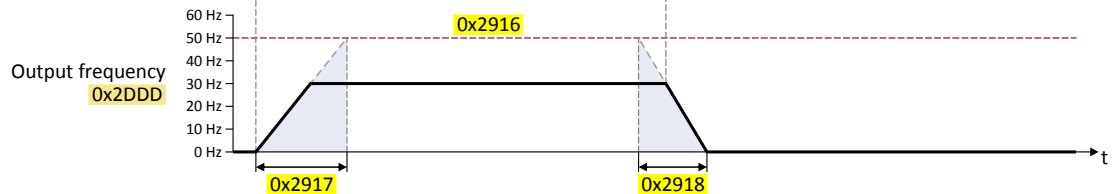

Automatic/manual change-over to ramp 2

- For ramp 2, the acceleration time 2 set in **0x2919 (P222.00)** and the deceleration time 2 set in **0x291A (P223.00)** apply.
- The change-over to ramp 2 is effected automatically if the frequency setpoint (absolute value) \geq auto-changeover threshold **0x291B (P224.00)**.

Input signals

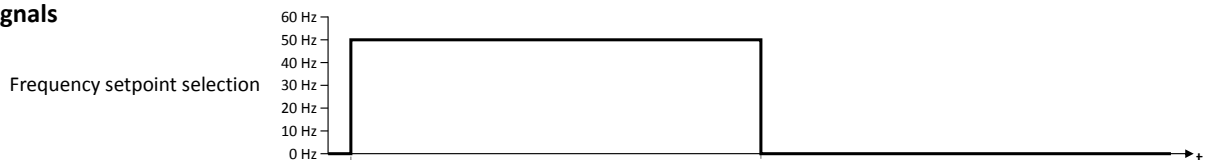

Output signals

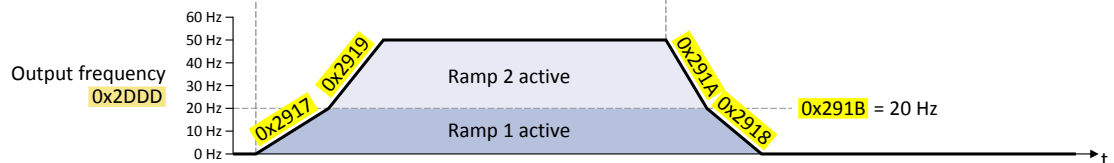

- The "Activate ramp 2" function serves to manually activate the acceleration time 2 and the deceleration time 2. [▶ Activating ramp 2 manually](#) [547](#)

Parameter	Name / value range / [default setting]	Info
0x2915 (P210.00)	Minimum frequency (Min. frequency) 0.0 ... [0.0] ... 599.0 Hz	Lower limit value for all frequency setpoints.
0x2916 (P211.00)	Maximum frequency (Max. frequency) Device for 50-Hz mains: 0.0 ... [50.0] ... 599.0 Hz Device for 60-Hz mains: 0.0 ... [60.0] ... 599.0 Hz	Upper limit value for all frequency setpoints.

Basic setting

Frequency limits and ramp times



Parameter	Name / value range / [default setting]	Info
0x2917 (P220.00)	Acceleration time 1 (Accelerat.time 1) 0.0 ... [5.0] ... 3600.0 s	Acceleration time 1 for the operating mode "MS: Velocity mode". <ul style="list-style-type: none"> The acceleration time set refers to the acceleration from standstill to the maximum frequency set. In the case of a lower setpoint selection, the actual acceleration time is reduced accordingly. Setting is not effective in the operating mode 0x6060 (P301.00) = "CiA: Velocity mode [2]". ▶ Device profile CiA 402 □ 426
0x2918 (P221.00)	Deceleration time 1 (Decelerat.time 1) 0.0 ... [5.0] ... 3600.0 s	Deceleration time 1 for the operating mode "MS: Velocity mode". <ul style="list-style-type: none"> The deceleration time set refers to the deceleration from the maximum frequency set to standstill. In the case of a lower actual frequency, the actual deceleration time is reduced accordingly. Setting is not effective in the operating mode 0x6060 (P301.00) = "CiA: Velocity mode [2]". ▶ Device profile CiA 402 □ 426
0x2919 (P222.00)	Acceleration time 2 (Accelerat.time 2) 0.0 ... [5.0] ... 3600.0 s	Acceleration time 2 for the operating mode "MS: Velocity mode". <ul style="list-style-type: none"> The acceleration time set refers to the acceleration from standstill to the maximum frequency set. In the case of a lower setpoint selection, the actual acceleration time is reduced accordingly. The acceleration time 2 is active if the frequency setpoint (absolute value) \geq auto switching threshold 0x291B (P224.00) or the trigger assigned to the function "Activate ramp 2" in 0x2631:039 (P400.39) = TRUE. The acceleration time 2 is also used for changing the MOP setpoint generated by the "motor potentiometer" function. Setting is not effective in the operating mode 0x6060 (P301.00) = "CiA: Velocity mode [2]". ▶ Device profile CiA 402 □ 426
0x291A (P223.00)	Deceleration time 2 (Decelerat.time 2) 0.0 ... [5.0] ... 3600.0 s	Deceleration time 2 for the operating mode "MS: Velocity mode". <ul style="list-style-type: none"> The deceleration time set refers to the deceleration from the maximum frequency set to standstill. In the case of a lower actual frequency, the actual deceleration time is reduced accordingly. The deceleration time 2 is active if the frequency setpoint (absolute value) \geq auto change-over threshold 0x291B (P224.00) or the trigger assigned to the function "Activate ramp 2" in 0x2631:039 (P400.39) = TRUE. The deceleration time 2 is also used for changing the MOP setpoint generated by the "motor potentiometer" function. Setting is not effective in the operating mode 0x6060 (P301.00) = "CiA: Velocity mode [2]". ▶ Device profile CiA 402 □ 426
0x291B (P224.00)	Auto-changeover threshold of ramp 2 (Ramp 2 thresh.) 0.0 ... [0.0] ... 599.0 Hz	Threshold for the automatic change-over to acceleration time 2 and deceleration time 2. <ul style="list-style-type: none"> The change-over is effected if the frequency setpoint (absolute value) \geq auto change-over threshold. With the setting 0, the automatic change-over function is deactivated.



Example for operating mode

Parameter	Name	Setting for this example
0x2631:001 (P400.01)	Enable inverter	Constant TRUE [1]
0x2631:002 (P400.02)	Run	Digital input 1 [11]
0x2915 (P210.00)	Minimum frequency	15 Hz
0x2916 (P211.00)	Maximum frequency	40 Hz
0x2917 (P220.00)	Acceleration time 1	4 s
0x2918 (P221.00)	Deceleration time 1	3 s

Input signals

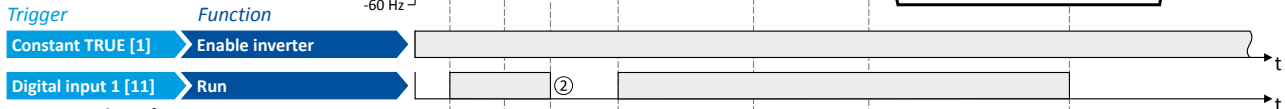
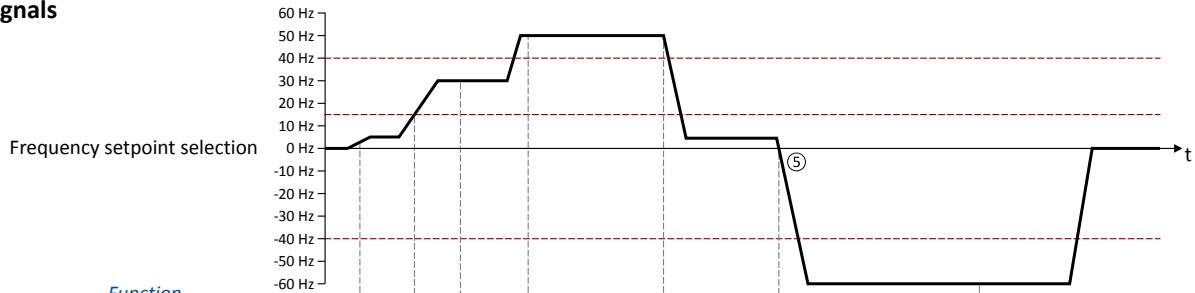

Output signals

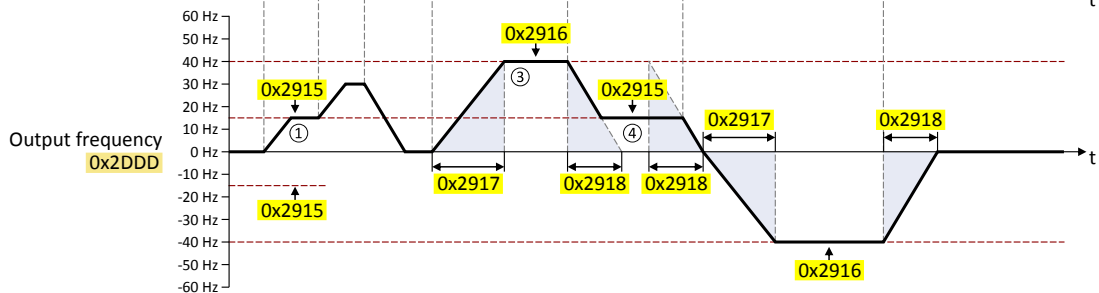

- ① After a start command, the motor is accelerated to the minimum frequency. This is also the case if the setpoint selection is = 0 Hz. If the setpoint exceeds the minimum frequency, the ramp generator follows the setpoint.
- ② If the start command is deactivated again, the motor is stopped with the stop method set in 0x2838:003 (P203.03) (here: Standard ramp).
- ③ The motor is accelerated to the set maximum frequency.
- ④ If the setpoint falls below the minimum frequency, it is decelerated up to the minimum frequency.
- ⑤ In case of a sign reversal of the setpoint, a change of direction of rotation takes place, minimum and maximum frequency, however, continue to apply.

Basic setting

Quick stop



6.6 Quick stop

The "quick stop" function is an alternative stop method if the motor has to be stopped faster than normal.



Cancelling the quick stop causes a restart of the motor if the start command is still active and the inverter is enabled!

Details

- Possible triggers to be selected for the "quick stop" function are available for example in [0x2631:003 \(P400.03\)](#) the digital inputs and internal status signals of the inverter.
- An activation via network is possible via the mappable NetWordIN1 data word or one of the predefined process data words. ▶ [General network settings](#) [□ 200](#)

Diagnostic parameters:

- [0x282A:002 \(P126.02\)](#) displays the cause of quick stop bit-coded.

Parameter	Name / value range / [default setting]	Info
0x291C (P225.00)	Quick stop deceleration time (QSP dec. time) 0.0 ... [1.0] ... 3600.0 s	Quick stop deceleration time for the operating mode "MS: Velocity mode". <ul style="list-style-type: none">• If the "Quick stop" function is activated, the motor is brought to a standstill within the deceleration time set here.• The deceleration time set refers to the deceleration from the maximum frequency set to standstill. In the case of a lower actual frequency, the actual deceleration time is reduced accordingly.• Setting is not effective in the operating mode 0x6060 (P301.00) = "CiA: Velocity mode [2]". ▶ Device profile CiA 402 □ 426
0x2631:003 (P400.03)	Function list: Activate quick stop (Function list: Quick stop) <ul style="list-style-type: none">• Setting can only be changed if the inverter is inhibited.• For further possible settings, see parameter 0x2631:001 (P400.01). □ 500	Assignment of a trigger for the "Activate quick stop" function. Trigger = TRUE: Activate quick stop. Trigger = FALSE: Deactivate quick stop. Notes: <ul style="list-style-type: none">• The "Quick stop" function brings the motor to a standstill within the deceleration time set in 0x291C (P225.00).
	0 Not connected	No trigger assigned (trigger is constantly FALSE).



Example for operating mode

Parameter	Name	Setting for this example
0x2631:001 (P400.01)	Enable inverter	Constant TRUE [1]
0x2631:002 (P400.02)	Run	Digital input 1 [11]
0x2631:003 (P400.03)	Activate quick stop	Digital input 2 [12]
0x2838:003 (P203.03)	Stop method	Standard ramp [1]
0x2916 (P211.00)	Maximum frequency	50 Hz
0x2917 (P220.00)	Acceleration time 1	4 s
0x2918 (P221.00)	Deceleration time 1	3 s
0x291C (P225.00)	Quick stop deceleration time	1 s

Input signals

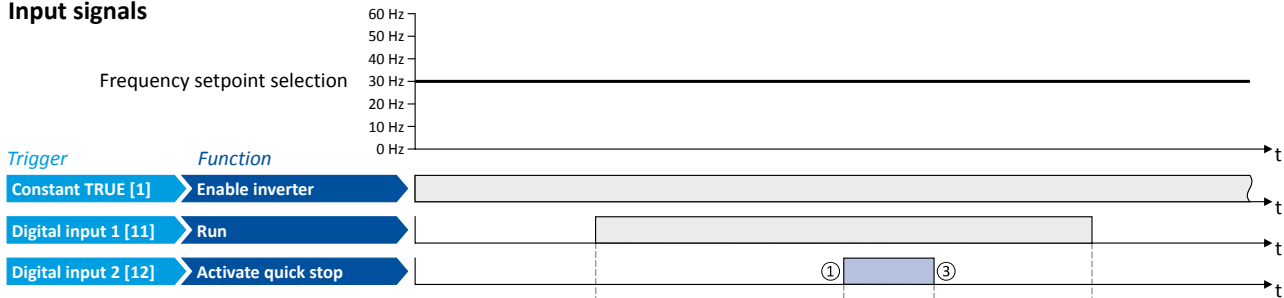

Output signals

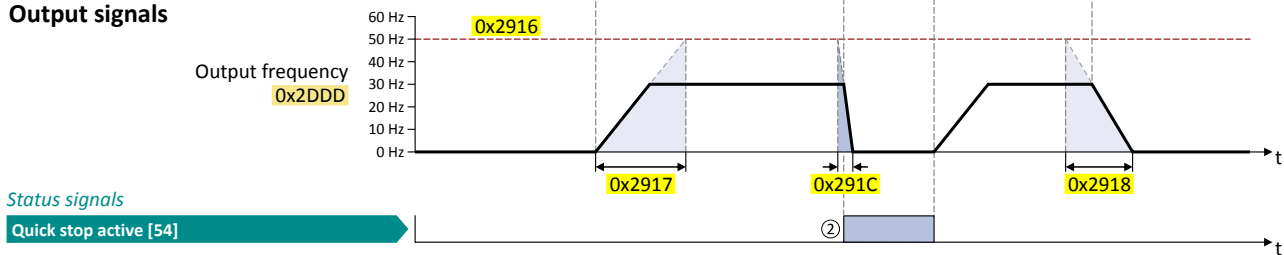

- ① Quick stop is activated: The motor is brought to a standstill within the deceleration time set in 0x291C (P225.00).
- ② If quick stop is active, the status signal "Quick stop active [54]" is set to TRUE. This status signal can be assigned via the Flexible I/O configuration of a function or a digital output.
- ③ Quick stop is deactivated again: The motor accelerates again to the setpoint since the start command is still active.

Basic setting

S-shaped ramps



6.7 S-shaped ramps

In order to reduce the jerk and to therefore prevent the drive components from damage, a smoothing factor can be set for the acceleration/deceleration ramps.

Details

In the default setting, the motor is accelerated and decelerated with linear ramps since this is the most used configuration. The setting of a smoothing factor causes S-shaped ramps. This leads to a smoother starting and braking behaviour which, for instance, is used for sensitive machine parts with backlash. It has to be observed here that the setting of a smoothing factor causes longer acceleration and delay times (see the following diagrams).

Input signals

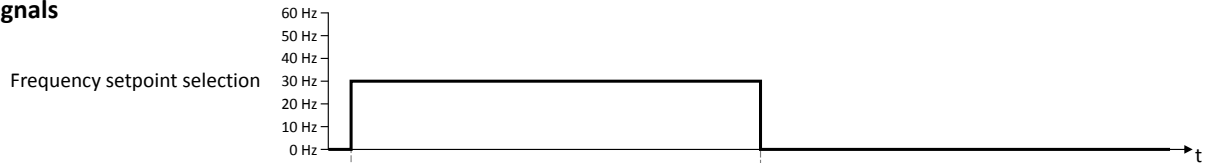

Output signals

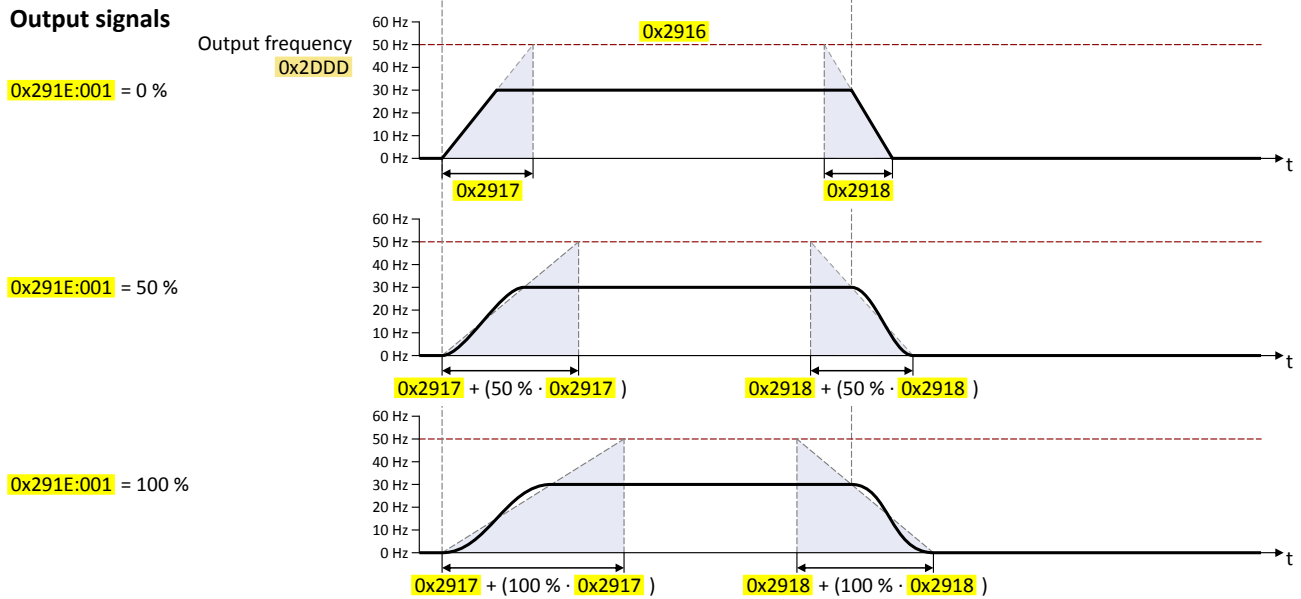

Parameter	Name / value range / [default setting]	Info
0x291E:001 (P226.01)	S-Ramp characteristic: Smoothing factor (S-ramp char.: Smoothing factor) 0.0 ... [0.0] ... 100.0 %	Factor for S-rounding of the acceleration/deceleration ramps. <ul style="list-style-type: none"> With the setting "0.0", the S-rounding is deactivated and acceleration/ deceleration with linear ramps is carried out.



6.8 Optical device identification

For applications including several interconnected inverters it may be difficult to locate a device that has been connected online. The "Optical device identification" function serves to locate the inverter by means of blinking LEDs.

Details

In order to start the visual tracking,

- click the button in the toolbar of the »EASY Starter«  or
- set [0x2021:001 \(P230.01\)](#) = "Start [1]".

After the start, both LEDs "RDY" and "ERR" on the front of the inverter synchronously blink very fast.

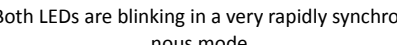
"RDY" LED (blue)	"ERR" LED (red)	Status/meaning
		"Visual tracking" function is active.
Both LEDs are blinking in a very rapidly synchronous mode		

The blinking duration can be set in [0x2021:002 \(P230.02\)](#) or selected in the »EASY Starter« in the dropdown list field:

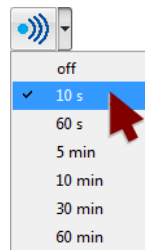

Parameter	Name / value range / [default setting]	Info
0x2021:001 (P230.01)	Optical tracking: Start detection (Optical tracking: Start detection)	1 = start optical device identification. <ul style="list-style-type: none"> • After the start, the two LEDs "RDY" and "ERR" on the front of the inverter are blinking with a blinking frequency of 20 Hz for the blinking duration set in 0x2021:002 (P230.02). The setting is then automatically reset to "0" again. • If the function is reactivated within the blinking time set, the time is extended correspondingly. • A manual reset to "0" makes it possible to stop the function prematurely.
	0 Stop 1 Start	
0x2021:002 (P230.02)	Optical tracking: Blinking duration (Optical tracking: Blink. duration) 0 ... [5] ... 3600 s	

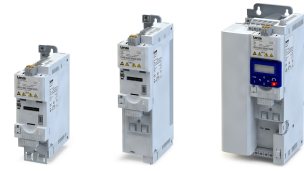

7 Motor control

This chapter contains all functions and settings relevant for the motor control.

Basic procedure of commissioning the motor control

In the first step, the rated data of the motor must be set. The other steps depend on the respective application case.

There are several options for setting the motor data and optimising the control loops. Basically, you can select between a manual and an automatic process. Whether a setting can be applied or not depends on the motor (Lenze motor yes/no) and the application. If possible, always use the possible setting listed first in the following diagram since this one leads to the most accurate results.

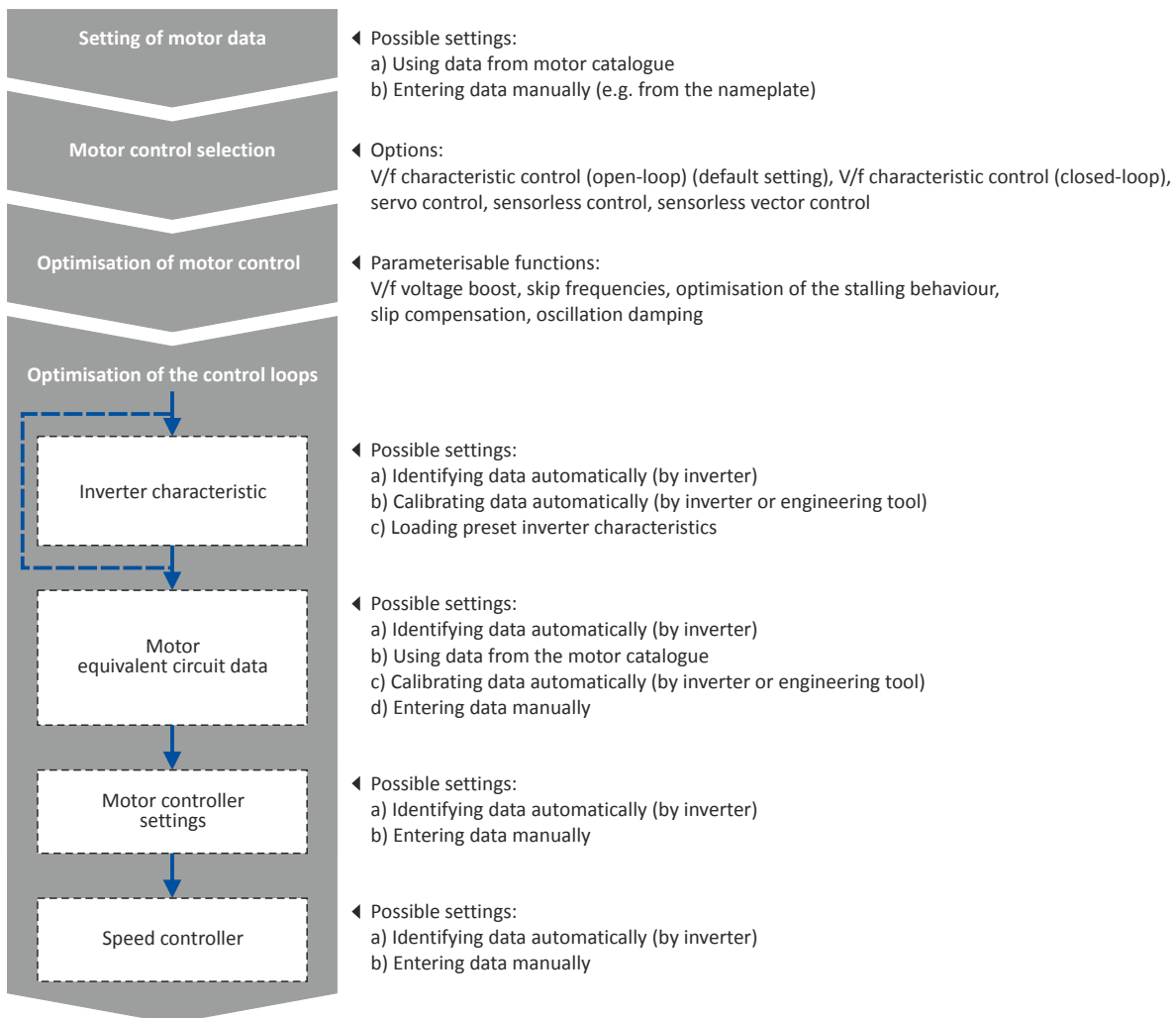

- [Motor data](#) 137
- [Motor control selection](#) 138
- [Optimisation of motor control](#) 154
- [Optimisation of the control loops](#) 165
- [Motor rotating direction](#) 185
- [Switching frequency changeover](#) 186
- [Motor protection](#) 187



7.1 Motor data

Setting of motor data

Motor control selection

Optimisation of motor control

Optimisation of the control loops

The term "motor data" comprises all parameters only depending on the motor and only characterising the electrical behaviour of the machine. Motor data are independent of the application in which the inverter and the motor are used.

Preconditions

When you enter the motor nameplate data, take into account the phase connection implemented for the motor (star or delta connection). Only enter the data applying to the connection type selected.

Possible settings

If a Lenze motor is connected to the inverter, you can simply select the used motor in the engineering tool from the "motor catalog".

- For details see chapter "[Motor selection from motor catalogue](#)". [169](#)

Otherwise the motor data has to be set manually (see the following subchapter).

7.1.1 Manual setting of the motor data

If an external motor is connected to the inverter, the motor data must be set manually in the following parameters according to the manufacturer information/motor data sheet.

Parameter	Name / value range / [default setting]	Info
0x2C01:001	Motor parameters: Number of pole pairs • Read only	Display of the number of pole pairs calculated from the rated speed and rated frequency.
0x2C01:004 (P320.04)	Motor parameters: Rated speed (Motor parameters: Rated speed) Device for 50-Hz mains: 50 ... [1450] ... 50000 rpm Device for 60-Hz mains: 50 ... [1750] ... 50000 rpm	General motor data. Carry out settings as specified by motor nameplate data. Note! When you enter the motor nameplate data, take into account the phase connection implemented for the motor (star or delta connection). Only enter the data applying to the connection type selected.
0x2C01:005 (P320.05)	Motor parameters: Rated frequency (Motor parameters: Rated frequency) Device for 50-Hz mains: 1.0 ... [50.0] ... 1000.0 Hz Device for 60-Hz mains: 1.0 ... [60.0] ... 1000.0 Hz	
0x2C01:006 (P320.06)	Motor parameters: Rated power (Motor parameters: Rated power) 0.00 ... [0.25]* ... 655.35 kW * Default setting depending on the size.	
0x2C01:007 (P320.07)	Motor parameters: Rated voltage (Motor parameters: Rated voltage) 0 ... [230]* ... 65535 V * Default setting depending on the size.	
0x2C01:008 (P320.08)	Motor parameters: Cosine phi (Motor parameters: Cosine phi) 0.00 ... [0.80] ... 1.00	
0x6075 (P323.00)	Motor rated current (Motor current) 0.001 ... [1.700]* ... 500.000 A * Default setting depending on the size. • Setting can only be changed if the inverter is inhibited.	The rated motor current to be set here serves as a reference value for different parameters with a setting/display of a current value in percent. Example: • Motor rated current = 1.7 A • Max current 0x6073 (P324.00) = 200 % Motor rated current = 3.4 A
0x6076 (P325.00)	Motor rated torque (Motor torque) 0.001 ... [1.650]* ... 1000.000 Nm * Default setting depending on the size. • Setting can only be changed if the inverter is inhibited.	The rated motor torque to be set here serves as a reference value for different parameters with a setting/display of a torque value in percent. Example: • Motor rated torque = 1.65 Nm • Max torque 0x6072 (P326.00) = 250 % Motor rated torque = 4.125 Nm
0x6080 (P322.00)	Max motor speed (Max motor speed) 0 ... [6075] ... 480000 rpm	Limitation of the maximum motor speed.

Motor control

Motor control selection
Manual setting of the motor data



7.2 Motor control selection

Setting of motor data

Motor control selection

Optimisation of motor control

Optimisation of the control loops

The inverter supports different modes for closed-loop/open-loop motor control.

Parameter	Name / value range / [default setting]	Info
0x2C00 (P300.00)	Motor control mode (Motor ctrl mode) <ul style="list-style-type: none">Setting can only be changed if the inverter is inhibited.	Selection of the motor control type.
	2 Servo control (SC ASM) (from version 02.00)	This control mode is used for servo control of an asynchronous motor. <ul style="list-style-type: none">Control mode is possible up to a rated power of maximally 45 kW. ▶ Servo control for asynchronous motors (SC-ASM) □ 148
	3 Sensorless control (SL PSM) (from version 02.00)	This control type is used for the sensorless control of a synchronous motor. <ul style="list-style-type: none">Control mode is possible up to a rated power of maximally 45 kW. ▶ Sensorless control for synchronous motors (SL-PSM) □ 150
	4 Sensorless vector control (SLVC)	This control type is used for sensorless vector control of an asynchronous motor. <ul style="list-style-type: none">Control mode is possible up to a rated power of maximally 45 kW. ▶ Sensorless vector control (SLVC) □ 145
	6 V/f characteristic control (VFC open loop)	This control mode is used for the speed control of an asynchronous motor via a V/f characteristic and is the simplest control mode. ▶ V/f characteristic control (VFC) □ 139
	7 V/f characteristic control (VFC closed loop) (from version 04.00)	The control mode is used for speed control of an asynchronous motor via a V/f characteristic with speed feedback. A motor encoder must be connected to the inverter and set as feedback system for the motor control. ▶ V/f characteristic control (VFC closed loop) □ 144

In the following subchapters, each motor control is described in detail.



7.2.1 V/f characteristic control (VFC)

The V/f characteristic control is a motor control for conventional frequency inverter applications. It is based on a simple and robust control mode for the operation of asynchronous motors with a linear or square-law load torque characteristic (e.g. fan). Because of the minimal parameterisation effort, such applications can be commissioned easily and quickly.

Preconditions

- The V/f characteristic control is only suitable for asynchronous motors.
- If you want to actuate a drive with a square-law V/f characteristic: please always check whether the corresponding drive is suitable for operation with a square-law V/f characteristic!
- From the motor nameplate data, at least the rated speed and rated frequency must be entered, so that the inverter can calculate the correct number of pole pairs. [▶ Motor data](#) [137](#)
- The motor must only be actuated above the rated motor frequency/rated voltage if this is expressly approved by the motor manufacturer!

Details

This motor control type is activated by setting **0x2C00 (P300.00)** = "V/f characteristic control (VFC open loop) [6]".

- **0x2B00 (P302.00)** provides different characteristic shapes which are described in detail in the following subchapters.
- Limiting factors for the V/f characteristic are rated mains voltage **0x2540:001 (P208.01)**, minimum frequency **0x2915 (P210.00)** and maximum frequency **0x2916 (P211.00)**.

Parameter	Name / value range / [default setting]	Info
0x2B00 (P302.00)	V/f characteristic shape (V/f charac.shape) • Setting can only be changed if the inverter is inhibited.	Selection of the V/f characteristic shape for the adaptation to different load profiles.
	0 Linear	Linear characteristic for drives with constant load torque over the speed. ▶ Linear V/f characteristic 140
	1 Quadratic	Square-law characteristic for drives with a linear or square-law load torque over the speed. • Square-law V/f characteristics are preferably used for centrifugal pumps and fan drives. • Please always check whether the corresponding drive is suitable for operation with a square-law V/f characteristic! • If your pump drive or fan drive is not suitable for operation with a square-law V/f characteristic, use the linear V/f characteristic instead. ▶ Square-law V/f characteristic 141
	2 Multipoint (from version 03.00)	Linear characteristics with an additional centre characteristic point for the purpose of adaptation to specific load profiles. ▶ User-definable V/f characteristic 142
	3 Eco (from version 02.00)	Linear characteristic with energy optimisation in the partial load operational range. ▶ V/f characteristic control - energy-saving (VFC Eco) 143
0x2B01:001 (P303.01)	V/f shape data: Base voltage (V/f shape data: Base voltage) 0 ... [230] * ... 5000 V * Default setting depending on the size.	Base voltage and base frequency define the V/f ratio and thus the gradient of the V/f characteristic. • The V/f base voltage is usually set to the rated motor voltage 0x2C01:007 (P320.07) .
0x2B01:002 (P303.02)	V/f shape data: Base frequency (V/f shape data: Base frequency) Device for 50-Hz mains: 0 ... [50] * ... 1500 Hz Device for 60-Hz mains: 0 ... [60] * ... 1500 Hz * Default setting depending on the size.	• The V/f base frequency is usually set to the rated motor frequency 0x2C01:005 (P320.05) .

Motor control

Motor control selection
V/f characteristic control (VFC)



7.2.1.1 Linear V/f characteristic

The linear V/f characteristic is the most used characteristic shape for general applications since they cause a torque that is largely constant.

Details

Select V/f characteristic control with linear characteristic:

1. Motor control mode [0x2C00 \(P300.00\)](#) = "V/f characteristic control (VFC open loop) [6]"
2. V/f characteristic shape [0x2B00 \(P302.00\)](#) = "Linear [0]"

Setting of the V/f characteristic:

- Limiting factors for the V/f characteristic are rated mains voltage [0x2540:001 \(P208.01\)](#), minimum frequency [0x2915 \(P210.00\)](#) and maximum frequency [0x2916 \(P211.00\)](#).
- The base voltage [0x2B01:001 \(P303.01\)](#) is usually set to the rated motor voltage (motor nameplate data). The base voltage is preset to the rated mains voltage. This again is preset according to the product key of the inverter. ▶ [Mains voltage](#) [119](#)
- The base frequency [0x2B01:002 \(P303.02\)](#) is usually set to the rated motor frequency (motor nameplate data).

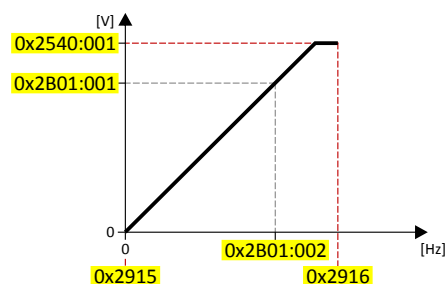

The current output frequency can exceed the set maximum frequency if the gain for the slip compensation in [0x2B09:001 \(P315.01\)](#) is set to a value higher than 0.

Example

In this example, a 400 V/50 Hz motor is connected to the inverter which is to be operated with maximally 75 Hz. The minimum frequency is set to 10 Hz.

- V/f characteristic on the left: The inverter is operated with a rated mains voltage of 400 V.
- V/f characteristic on the right: The inverter is operated with a rated mains voltage of 480 V. This causes the output voltage to further increase above 50 Hz.

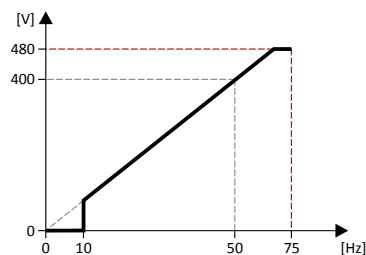
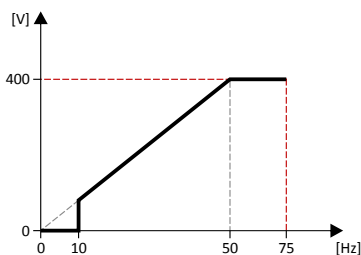

Parameter	Name	Setting for this example
0x2540:001 (P208.01)	Rated mains voltage	400 Veff [1] (on the left) / 480 Veff [2] (on the right)
0x2915 (P210.00)	Minimum frequency	10 Hz
0x2916 (P211.00)	Maximum frequency	75 Hz
0x2B01:001 (P303.01)	Base voltage	400 V
0x2B01:002 (P303.02)	Base frequency	50 Hz

Next steps

- The inverter provides different functions by means of which the drive behaviour can be further optimised. ▶ [Optimisation of motor control](#) [154](#)
- A optimisation of the control loops is not mandatory for this motor control type but may lead to a better control mode. ▶ [Optimisation of the control loops](#) [165](#)



7.2.1.2 Square-law V/f characteristic

The square-law V/f characteristic is typically used in heating, ventilation and climate applications to control the speed of fans and pumps.

Details

Each application that is provided with the features according to the affinity laws may possibly benefit from a square-law V/f characteristic.

The affinity laws describe the relation between the speed and other variables:

- The volume flow increases proportionately to the speed.
- The required pressure behaves proportionately to the square of the speed.
- The power input is proportionately to the cube of the speed. This means that already a minimal reduction of the speed may lead to substantial savings in energy consumption.

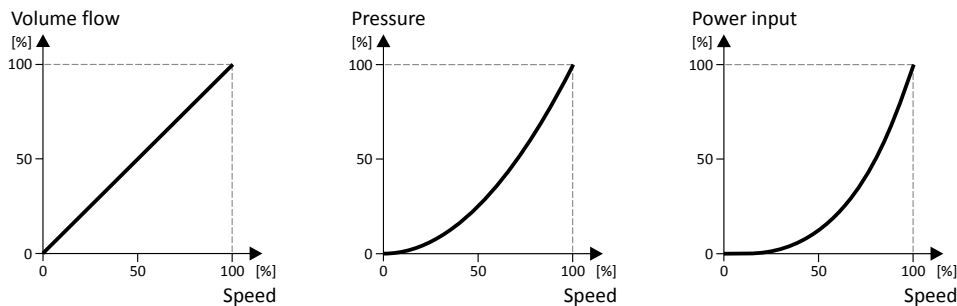

By approximation, the square-law V/f characteristic corresponds to the curve for power input shown above. At low frequencies, the voltage is reduced since due to the type of load a lower voltage is sufficient to generate the required power. All in all, this results in an energy-efficient system.

Select V/f characteristic control with square-law characteristic:

1. Motor control mode `0x2C00 (P300.00)` = "V/f characteristic control (VFC open loop) [6]"
2. V/f characteristic shape `0x2B00 (P302.00)` = "Quadratic [1]"

Setting of the V/f characteristic:

- Limiting factors for the V/f characteristic are rated mains voltage `0x2540:001 (P208.01)`, minimum frequency `0x2915 (P210.00)` and maximum frequency `0x2916 (P211.00)`.
- The base voltage `0x2B01:001 (P303.01)` is usually set to the rated motor voltage (motor nameplate data). The base voltage is preset to the rated mains voltage. This again is preset according to the product key of the inverter. ▶ [Mains voltage](#) [119](#)
- The base frequency `0x2B01:002 (P303.02)` is usually set to the rated motor frequency (motor nameplate data).

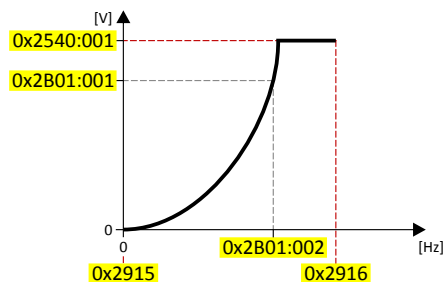

The current output frequency can exceed the set maximum frequency if the gain for the slip compensation in `0x2B09:001 (P315.01)` is set to a value higher than 0.

Next steps

- The inverter provides different functions by means of which the drive behaviour can be further optimised. ▶ [Optimisation of motor control](#) [154](#)
- A optimisation of the control loops is not mandatory for this motor control type but may lead to a better control mode. ▶ [Optimisation of the control loops](#) [165](#)

Motor control

Motor control selection
V/f characteristic control (VFC)



7.2.1.3 User-definable V/f characteristic

The user-definable V/f characteristic is based on the linear V/f characteristic. An additional medium characteristic point, however, enables the adaptation to applications with special torque properties.

Details

An application case for this characteristic shape are applications that require a higher torque at lower speeds. The additional medium characteristic point can be then configured in such a way that more voltage is provided in the lower frequency range of the characteristic. Otherwise, the same limits apply for the adaptive characteristic as for the linear characteristic.

Select V/f characteristic control with adaptive characteristic:

1. Motor control mode `0x2C00 (P300.00)` = "V/f characteristic control (VFC open loop) [6]"
2. V/f characteristic shape `0x2B00 (P302.00)` = "Multipoint [2]"

Setting of the V/f characteristic:

- Limiting factors for the V/f characteristic are rated mains voltage `0x2540:001 (P208.01)`, minimum frequency `0x2915 (P210.00)` and maximum frequency `0x2916 (P211.00)`.
- The base voltage `0x2B01:001 (P303.01)` is usually set to the rated motor voltage (motor nameplate data). The base voltage is preset to the rated mains voltage. This again is preset according to the product key of the inverter. ▶ [Mains voltage](#) □ 119
- The base frequency `0x2B01:002 (P303.02)` is usually set to the rated motor frequency (motor nameplate data).
- The additional medium characteristic point is defined based on the parameters `0x2B01:003 (P303.03)` and `0x2B01:004 (P303.04)`.

Characteristic examples:

- Example on the left: Base voltage is set equal to rated mains voltage
- Example on the right: Base voltage is set lower than rated mains voltage

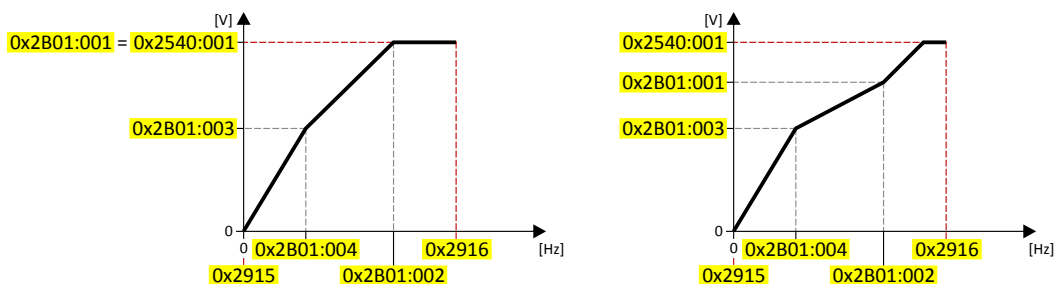

Parameter	Name / value range / [default setting]	Info
<code>0x2B01:003 (P303.03)</code>	V/f shape data: Midpoint voltage (V/f shape data: Midpoint voltage) 0 ... [0] ... 5000 V • From version 03.00	Definition of the medium characteristic point for user-definable V/f characteristic. • Only relevant if V/f characteristic shape <code>0x2B00 (P302.00)</code> is set = "Multipoint [2]".
<code>0x2B01:004 (P303.04)</code>	V/f shape data: Midpoint frequency (V/f shape data: Midpoint freq) 0 ... [0] ... 1500 Hz • From version 03.00	

Next steps

- The inverter provides different functions by means of which the drive behaviour can be further optimised. ▶ [Optimisation of motor control](#) □ 154
- A optimisation of the control loops is not mandatory for this motor control type but may lead to a better control mode. ▶ [Optimisation of the control loops](#) □ 165

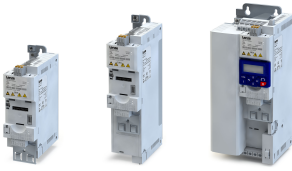

7.2.1.4 V/f characteristic control - energy-saving (VFC Eco)

In case of the energy-saving V/f characteristic control (VFCplusEco), the motor voltage of the inverter is detected by means of a linear characteristic as a function of the rotating field frequency or motor speed to be generated. Moreover, the motor is always driven in the optimal efficiency range via a cosφ control and the resulting voltage reduction (reduced copper losses in the asynchronous motor).

Details

Select energy-saving V/f characteristic control with linear characteristic:

1. Motor control mode `0x2C00 (P300.00)` = "V/f characteristic control (VFC open loop) [6]"
2. V/f characteristic shape `0x2B00 (P302.00)` = "Eco [3]"

Setting of the V/f characteristic:

- Limiting factors for the V/f characteristic are rated mains voltage `0x2540:001 (P208.01)`, minimum frequency `0x2915 (P210.00)` and maximum frequency `0x2916 (P211.00)`.
- The base voltage `0x2B01:001 (P303.01)` is usually set to the rated motor voltage (motor nameplate data). The base voltage is preset to the rated mains voltage. This again is preset according to the product key of the inverter. ▶ [Mains voltage](#) 119
- The base frequency `0x2B01:002 (P303.02)` is usually set to the rated motor frequency (motor nameplate data).

Eco efficiency range:

- The Eco efficiency range (grey) is between the V/f-standard characteristic (black) and the V/f Eco characteristic (green).
- The V/f Eco characteristic (green) is defined by the operating point that results from the minimum voltage `0x2B0D:001 (P330.01)` and the base frequency `0x2B01:002 (P303.02)`.
- The minimum voltage `0x2B0D:001 (P330.01)` has to be set in percent with reference to the base voltage `0x2B01:001 (P303.01)`.

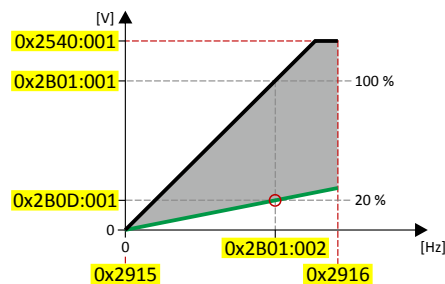

The current output frequency can exceed the set maximum frequency if the gain for the slip compensation in `0x2B09:001 (P315.01)` is set to a value higher than 0.

Parameter	Name / value range / [default setting]	Info
<code>0x2B0D:001 (P330.01)</code>	VFC-ECO: Minimum voltage (VFC-ECO: Min. voltage) 20 ... [20] ... 100 % • From version 02.00	Defining the operating point of the V/f eco characteristic. The V/f eco characteristic defines the lower limit of the eco efficiency range. • 100 % ≙ Base voltage <code>0x2B01:001 (P303.01)</code>

Next steps

- The inverter provides different functions by means of which the drive behaviour can be further optimised. ▶ [Optimisation of motor control](#) 154
- A optimisation of the control loops is not mandatory for this motor control type but may lead to a better control mode. ▶ [Optimisation of the control loops](#) 165

Motor control

Motor control selection

V/f characteristic control (VFC closed loop)



7.2.2 V/f characteristic control (VFC closed loop)

The V/f characteristic control with feedback (VFC closed loop) can be used if an asynchronous motor with motor encoder is connected to the inverter.

The speed feedback leads to the following advantages:

- Stationary speed accuracy
- Improved dynamics compared to the V/f characteristic control without feedback (VFC open loop) or to the encoderless vector control (SLVC)
- Suitability for group drives

Preconditions

- The V/f characteristic control (VFC closed loop) is only suitable for asynchronous motors.
- The V/f characteristic control (VFC closed loop) requires a feedback of the speed. A motor encoder must be connected to the inverter and set as feedback system for the motor control.
 - This setting is not made automatically if a motor is selected from the motor catalog.
 - For required settings see chapter "HTL encoder". [□ 450](#)
- If you want to actuate a drive with a square-law V/f characteristic: please always check whether the corresponding drive is suitable for operation with a square-law V/f characteristic!
- From the motor nameplate data, at least the rated speed and rated frequency must be entered, so that the inverter can calculate the correct number of pole pairs. [▶ Motor data □ 137](#)
- The motor must only be actuated above the rated motor frequency/rated voltage if this is expressly approved by the motor manufacturer!

Details

This motor control type is activated by setting `0x2C00 (P300.00)` = "V/f characteristic control (VFC closed loop) [7]".

- `0x2B00 (P302.00)` provides different characteristic shapes.
- Limiting factors for the V/f characteristic are rated mains voltage `0x2540:001 (P208.01)`, minimum frequency `0x2915 (P210.00)` and maximum frequency `0x2916 (P211.00)`.
- The slip compensation is deactivated in this motor control type. In case of V/f characteristic control with feedback, the slip is calculated and injected by the slip regulator. [▶ Slip controller □ 183](#)

Next steps

- The inverter provides different functions by means of which the drive behaviour can be further optimised. [▶ Optimisation of motor control □ 154](#)
- An optimisation of the control loops is not mandatory for this motor control type but may lead to a better control mode. [▶ Optimisation of the control loops □ 165](#)



7.2.3 Sensorless vector control (SLVC)

Sensorless (field-oriented) vector control for asynchronous motors is based on a decoupled, separate control for the torque-producing and the field-producing current component. In addition, the actual speed is reconstructed by means of a motor model so that a speed sensor is not required.

Preconditions

- Sensorless vector control (SLVC) is only suitable for asynchronous motors.
- The sensorless vector control (SLVC) is possible up to a rated power of maximally 45 kW.
- Operation of the sensorless vector control (SLVC) is only permissible for one single drive!
- Operation of the sensorless vector control (SLVC) is **not** permissible for hoists!

Supported operating modes [0x6060 \(P301.00\)](#):

- "MS: Velocity mode [-2]"
- "MS: Torque mode [-1]"
- "CiA: Velocity mode [2]"

Details

This motor control type is activated by setting [0x2C00 \(P300.00\)](#) = "Sensorless vector control (SLVC) [4]".

Compared to the V/f characteristics, the sensorless vector control (SLVC) serves to achieve improved drive characteristics thanks to:

- higher torque throughout the entire speed range
- higher speed accuracy and higher concentricity factor
- higher efficiency

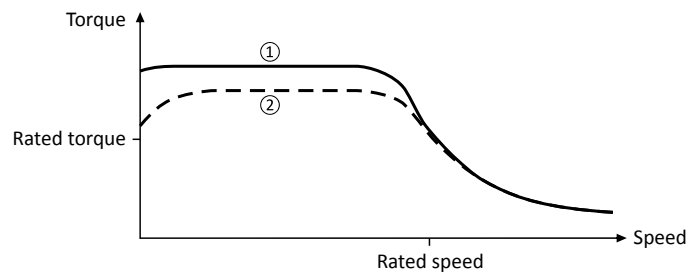

- ① Sensorless vector control (SLVC)
- ② [V/f characteristic control \(VFC\)](#) [□ 139](#)

For a speed control with torque limitation in operating mode [0x6060 \(P301.00\)](#) = "MS: Velocity mode [-2]":

1. Select the source in [0x2949:001 \(P337.01\)](#) for the positive torque limit source and set it accordingly.
2. Select the source in [0x2949:002 \(P337.02\)](#) for the negative torque limit source and set it accordingly.

Alternatively, the inverter can be configured in this motor control type in such a way that it controls a motor torque within a defined frequency range. For details, see chapter "[Torque control w/ freq. limit](#)". [□ 179](#)

Parameter	Name / value range / [default setting]	Info
0x2B40:003	Q-Feedforward 0.00 ... [0.00] ... 10000.00 • From version 03.00	Feedforward control for the SLVC Q controller.
0x2B40:004	D-Feedforward 0.00 ... [0.00] ... 10000.00 • From version 03.00	Feedforward control of the SLVC-D controller.

Motor control

Motor control selection

Sensorless vector control (SLVC)



Parameter	Name / value range / [default setting]	Info
0x2949:001 (P337.01)	Positive torque limit source (Pos. torqlim src) • From version 03.00	Selection of the source for the positive torque limit source.
	0 Max torque	Positive torque limit source = Max torque 0x6072 (P326.00).
	1 Fixed Limit 0.0 %	Positive torque limit source = 0.0 %.
	2 Analog Input 1	The positive torque limit source is defined as analog signal via the analog input 1. ▶ Analog input 1 □ 568
	3 Analog Input 2	The positive torque limit source is defined as analog signal via the analog input 2. ▶ Analog input 2 □ 572
	4 Positive torque limit	Positive torque limit source = Positive torque limit 0x60E0.
0x2949:002 (P337.02)	Negative torque limit source (Neg. torqlim src) • From version 03.00	Selection of the source for the negative torque limit source.
	0 (-) Max torque	Negative torque limit source = (-) Max torque 0x6072 (P326.00).
	1 Fixed Limit 0.0 %	Negative torque limit source = 0.0 %.
	2 Analog Input 1	The negative torque limit source is defined as analog signal via the analog input 1. ▶ Analog input 1 □ 568
	3 Analog Input 2	The negative torque limit source is defined as analog signal via the analog input 2. ▶ Analog input 2 □ 572
	4 Negative torque limit	Negative torque limit source = Negative torque limit 0x60E1.
0x2C00 (P300.00)	Motor control mode (Motor ctrl mode) • Setting can only be changed if the inverter is inhibited.	Selection of the motor control type.
	2 Servo control (SC ASM) (from version 02.00)	This control mode is used for servo control of an asynchronous motor. • Control mode is possible up to a rated power of maximally 45 kW. ▶ Servo control for asynchronous motors (SC-ASM) □ 148
	3 Sensorless control (SL PSM) (from version 02.00)	This control type is used for the sensorless control of a synchronous motor. • Control mode is possible up to a rated power of maximally 45 kW. ▶ Sensorless control for synchronous motors (SL-PSM) □ 150
	4 Sensorless vector control (SLVC)	This control type is used for sensorless vector control of an asynchronous motor. • Control mode is possible up to a rated power of maximally 45 kW. ▶ Sensorless vector control (SLVC) □ 145
	6 V/f characteristic control (VFC open loop)	This control mode is used for the speed control of an asynchronous motor via a V/f characteristic and is the simplest control mode. ▶ V/f characteristic control (VFC) □ 139
	7 V/f characteristic control (VFC closed loop) (from version 04.00)	The control mode is used for speed control of an asynchronous motor via a V/f characteristic with speed feedback. A motor encoder must be connected to the inverter and set as feedback system for the motor control. ▶ V/f characteristic control (VFC closed loop) □ 144



Motor control

Motor control selection

Sensorless vector control (SLVC)

Parameter	Name / value range / [default setting]	Info
0x6060 (P301.00)	Modes of operation (Modes of op.) • Setting can only be changed if the inverter is inhibited.	Selection of the operating mode.
	-2 MS: Velocity mode	Vendor specific velocity mode
	-1 MS: Torque mode (from version 03.00)	Vendor specific torque mode • Only possible in motor control type 0x2C00 (P300.00) = "Sensorless vector control (SLVC) [4]". ▶ Torque control w/ freq. limit 179
	0 No mode change/no mode assigned	No operating mode (standstill)
	2 CiA: Velocity mode	CiA 402 velocity mode

Next steps

- The inverter provides different functions by means of which the drive behaviour can be further optimised. ▶ [Optimisation of motor control](#) [154](#)
- The default setting enables the operation of a power-adapted motor. **An optimum operation of this motor control type requires an optimisation of the control loops!** ▶ [Optimisation of the control loops](#) [165](#)
- If the inverter is to control a motor torque within a defined frequency range, the torque control must be configured accordingly after the control loops are optimised. ▶ [Torque control w/ freq. limit](#) [179](#)

Motor control

Motor control selection

Servo control for asynchronous motors (SC-ASM)



7.2.4 Servo control for asynchronous motors (SC-ASM)

The field-oriented servo control is based on a decoupled, separated control of the torque-producing and field-producing current share. The motor control is based on a feedback, field-oriented and cascaded controller structure and enables a dynamic and stable operation in all four quadrants.

Preconditions

- The servo control (SC ASM) is only suitable for asynchronous motors.
- The servo control (SC ASM) is possible up to a rated power of maximally 45 kW.
- The servo control (SC-ASM) requires a feedback of the speed. A motor encoder must be connected to the inverter and set as feedback system for the motor control.
 - This setting is not made automatically if a motor is selected from the motor catalog.
 - For required settings see chapter "HTL encoder". [📖 450](#)

Details

This motor control type is activated by setting **0x2C00 (P300.00)** = " Servo control (SC ASM) [2]".

Basically, the servo control has the same advantages as the sensorless vector control (SLVC). Compared to the V/f characteristic control without feedback, the following can be achieved by means of the servo control:

- A higher maximum torque throughout the entire speed range
- A higher speed accuracy
- A higher concentricity factor
- A higher level of efficiency
- The implementation of torque-actuated operation with speed limitation
- The limitation of the maximum torque in motor and generator mode for speed-actuated operation

For a speed control with torque limitation in operating mode **0x6060 (P301.00)** = "MS: Velocity mode [-2]":

1. Select the source in **0x2949:001 (P337.01)** for the positive torque limit source and set it accordingly.
2. Select the source in **0x2949:002 (P337.02)** for the negative torque limit source and set it accordingly.

Parameter	Name / value range / [default setting]	Info
0x2901	Speed controller gain adaption 0.00 ... [100.00] ... 200.00 % • From version 04.00	Mappable parameter for adaptive adjustment of the speed controller gain via network.
0x2949:001 (P337.01)	Positive torque limit source (Pos. torqlim src) • From version 03.00	Selection of the source for the positive torque limit source.
	0 Max torque	Positive torque limit source = Max torque 0x6072 (P326.00) .
	1 Fixed Limit 0.0 %	Positive torque limit source = 0.0 %.
	2 Analog Input 1	The positive torque limit source is defined as analog signal via the analog input 1. ▶ Analog input 1 📖 568
	3 Analog Input 2	The positive torque limit source is defined as analog signal via the analog input 2. ▶ Analog input 2 📖 572
	4 Positive torque limit	Positive torque limit source = Positive torque limit 0x60E0 .
5 Network target torque	The positive torque limit source is defined as process data object via network. ▶ Configuring the network 📖 199	



Motor control

Motor control selection

Servo control for asynchronous motors (SC-ASM)

Parameter	Name / value range / [default setting]	Info
0x2949:002 (P337.02)	Negative torque limit source (Neg. torqlim src) • From version 03.00	Selection of the source for the negative torque limit source.
	0 (-) Max torque	Negative torque limit source = (-) Max torque 0x6072 (P326.00) .
	1 Fixed Limit 0.0 %	Negative torque limit source = 0.0 %.
	2 Analog Input 1	The negative torque limit source is defined as analog signal via the analog input 1. ▶ Analog input 1 1568
	3 Analog Input 2	The negative torque limit source is defined as analog signal via the analog input 2. ▶ Analog input 2 1572
	4 Negative torque limit	Negative torque limit source = Negative torque limit 0x60E1 .
0x2C00 (P300.00)	Motor control mode (Motor ctrl mode) • Setting can only be changed if the inverter is inhibited.	Selection of the motor control type.
	2 Servo control (SC ASM) (from version 02.00)	This control mode is used for servo control of an asynchronous motor. • Control mode is possible up to a rated power of maximally 45 kW. ▶ Servo control for asynchronous motors (SC-ASM) 148
	3 Sensorless control (SL PSM) (from version 02.00)	This control type is used for the sensorless control of a synchronous motor. • Control mode is possible up to a rated power of maximally 45 kW. ▶ Sensorless control for synchronous motors (SL-PSM) 150
	4 Sensorless vector control (SLVC)	This control type is used for sensorless vector control of an asynchronous motor. • Control mode is possible up to a rated power of maximally 45 kW. ▶ Sensorless vector control (SLVC) 145
	6 V/f characteristic control (VFC open loop)	This control mode is used for the speed control of an asynchronous motor via a V/f characteristic and is the simplest control mode. ▶ V/f characteristic control (VFC) 139
	7 V/f characteristic control (VFC closed loop) (from version 04.00)	The control mode is used for speed control of an asynchronous motor via a V/f characteristic with speed feedback. A motor encoder must be connected to the inverter and set as feedback system for the motor control. ▶ V/f characteristic control (VFC closed loop) 144
0x2C01:010	Motor parameters: Motor name	The name (e.g. "1") can be freely selected by the user. If the motor in the engineering tool has been selected from the "motor catalog", the respective motor name is automatically entered here (example: "MDSKA080-22, 70").

Next steps

- The inverter provides different functions by means of which the drive behaviour can be further optimised. ▶ [Optimisation of motor control](#) [154](#)
- The default setting enables the operation of a power-adapted motor. **An optimum operation of this motor control type requires an optimisation of the control loops!** ▶ [Optimisation of the control loops](#) [165](#)

Motor control

Motor control selection

Sensorless control for synchronous motors (SL-PSM)



7.2.5 Sensorless control for synchronous motors (SL-PSM)

The sensorless control for synchronous motors is based on a decoupled, separated control of the torque-producing current and the current in field direction. In contrast to the servo control, the actual speed value and rotor position are reconstructed via a motor model.

i NOTICE

In case of this motor control type, an adjustable, constant current is injected in the lower speed range. If this current is higher than the rated motor current, the motor may heat up in the lower speed range. This effect increases if the motor is operated in the lower speed range for a longer period of time.

Possible consequence: Destruction of the motor by overheating

- ▶ Do not operate the motor for a longer period of time in the lower speed range.
- ▶ For detecting and monitoring the motor temperature, we recommend a temperature feedback via PTC thermistor or thermal contact. ▶ [Motor temperature monitoring](#)  192

Preconditions

The sensorless control for synchronous motors (SL-PSM) is possible up to a rated power of maximally 45 kW.

Details

This motor control type is activated by setting `0x2C00 (P300.00)` = "Sensorless control (SL PSM) [3]".

The motor model-based speed observer requires a rotating machine. Thus, as a matter of principle, the operational performance of the sensorless control for synchronous motors is divided into two ranges:

1. Low speed range ($|\text{setpoint speed}| < \text{lower limit } 0x2C11:001$)
 - In the range of low speed, the speed of a synchronous motor cannot be observed. In this "Low speed range", an open-loop controlled operation takes place: For acceleration processes, the current set in `0x2C12:001` is injected and for processes without acceleration (for instance standstill or constant setpoint speed) the current set in `0x2C12:002` is injected.
2. High speed range ($|\text{setpoint speed}| > \text{lower limit } 0x2C11:001$)
 - In this area, the rotor flux position and the speed are reconstructed by means of an observer. The control is executed in a field-oriented way. Only the current required for generating the necessary torque is injected.

Pole position identification (PLI)

- For controlling a permanent-magnet synchronous motor, the pole position - the angle between the motor phase U and the field axis of the rotor - must be known.
- In case of a drive at standstill, the inverter enable is directly followed by the "pole position identification (PLI)" which identifies the initial pole position. ▶ [Synchronous motor: Pole position identification \(PPI\)](#)  163

Flying restart circuit

- From firmware version 4 onwards, a flying restart circuit for the synchronous motor up to speeds lower than half the rated speed is supported.
- If the flying restart circuit shall be used, set the start method "Flying restart circuit [2]" in `0x2838:001 (P203.01)`. More settings are not required for the flying restart circuit at sensorless control of a synchronous motor.

For a speed control with torque limitation in operating mode `0x6060 (P301.00)` = "MS: Velocity mode [-2]":

1. Select the source in `0x2949:001 (P337.01)` for the positive torque limit source and set it accordingly.
2. Select the source in `0x2949:002 (P337.02)` for the negative torque limit source and set it accordingly.



SL-PSM parameters

The parameters for this motor control type are calculated and set automatically while optimising the control loops. ▶ [Optimisation of the control loops](#) 165

Parameter	Name / value range / [default setting]	Info
0x2C03:001 (P352.01)	Back EMF constant (BEMF constant) 0.0 ... [41.8] ... 100000.0 V/1000rpm • From version 02.00	Voltage induced by the motor (rotor voltage / 1000 rpm).
0x2C11:001	High speed range: Lower limit 5 ... [30] ... 100 % • From version 02.00	Definition of the lower limit of the high speed range. • The lower limit has a permanent hysteresis of 5 %.
0x2C11:002	High speed range: Tracking controller gain 0 ... [200] ... 65535 % • From version 02.00	Gain factor for tracking the rotor position in the motor model.
0x2C11:003	High speed range: Tracking controller reset time 0.00 ... [6.00] ... 655.35 ms • From version 02.00	Reset time for tracking the rotor position in the motor model.
0x2C11:004	High speed range: Tracking controller decouple time 0.0 ... [200.0] ... 6553.5 ms • From version 02.00	Temporal hysteresis for the switching back and forth from the open-loop controlled to the closed-loop controlled operation.
0x2C12:001	SM low speed range: Acceleration current 5 ... [100] ... 400 % • From version 02.00	R.m.s. current value for acceleration processes in the lower velocity range. • 100 % ≙ rated motor current 0x6075 (P323.00) • In case of a "100 %" setting and at standstill, a motor current flows that is square root of 2 higher than the rated current. But as soon as the motor rotates, the effective rated current flows.
0x2C12:002	SM low speed range: Standstill current 5 ... [40] ... 400 % • From version 02.00	R.m.s. current value for processes without acceleration (for instance standstill or constant setpoint speed) in the lower velocity range. • 100 % ≙ rated motor current 0x6075 (P323.00)
0x2949:001 (P337.01)	Positive torque limit source (Pos. torqlim src) • From version 03.00	Selection of the source for the positive torque limit source.
	0 Max torque	Positive torque limit source = Max torque 0x6072 (P326.00) .
	1 Fixed Limit 0.0 %	Positive torque limit source = 0.0 %.
	2 Analog Input 1	The positive torque limit source is defined as analog signal via the analog input 1. ▶ Analog input 1 568
	3 Analog Input 2	The positive torque limit source is defined as analog signal via the analog input 2. ▶ Analog input 2 572
	4 Positive torque limit	Positive torque limit source = Positive torque limit 0x60E0 .
	5 Network target torque	The positive torque limit source is defined as process data object via network. ▶ Configuring the network 199
0x2949:002 (P337.02)	Negative torque limit source (Neg. torqlim src) • From version 03.00	Selection of the source for the negative torque limit source.
	0 (-) Max torque	Negative torque limit source = (-) Max torque 0x6072 (P326.00) .
	1 Fixed Limit 0.0 %	Negative torque limit source = 0.0 %.
	2 Analog Input 1	The negative torque limit source is defined as analog signal via the analog input 1. ▶ Analog input 1 568
	3 Analog Input 2	The negative torque limit source is defined as analog signal via the analog input 2. ▶ Analog input 2 572
	4 Negative torque limit	Negative torque limit source = Negative torque limit 0x60E1 .
	5 Network target torque	The negative torque limit source is defined as process data object via network. ▶ Configuring the network 199

Motor control

Motor control selection

Sensorless control for synchronous motors (SL-PSM)



Parameter	Name / value range / [default setting]	Info
0x2C00 (P300.00)	Motor control mode (Motor ctrl mode) • Setting can only be changed if the inverter is inhibited.	Selection of the motor control type.
	2 Servo control (SC ASM) (from version 02.00)	This control mode is used for servo control of an asynchronous motor. • Control mode is possible up to a rated power of maximally 45 kW. ▶ Servo control for asynchronous motors (SC-ASM) 148
	3 Sensorless control (SL PSM) (from version 02.00)	This control type is used for the sensorless control of a synchronous motor. • Control mode is possible up to a rated power of maximally 45 kW. ▶ Sensorless control for synchronous motors (SL-PSM) 150
	4 Sensorless vector control (SLVC)	This control type is used for sensorless vector control of an asynchronous motor. • Control mode is possible up to a rated power of maximally 45 kW. ▶ Sensorless vector control (SLVC) 145
	6 V/f characteristic control (VFC open loop)	This control mode is used for the speed control of an asynchronous motor via a V/f characteristic and is the simplest control mode. ▶ V/f characteristic control (VFC) 139
	7 V/f characteristic control (VFC closed loop) (from version 04.00)	The control mode is used for speed control of an asynchronous motor via a V/f characteristic with speed feedback. A motor encoder must be connected to the inverter and set as feedback system for the motor control. ▶ V/f characteristic control (VFC closed loop) 144
0x60E0	Positive torque limit 0.0 ... [250.0] ... 3276.7 % • From version 02.00	Positive torque limit source for speed control with torque limitation. • 100 % ≙ Motor rated torque 0x6076 (P325.00)
0x60E1	Negative torque limit 0.0 ... [250.0] ... 3276.7 % • From version 02.00	Negative torque limit source for speed control with torque limitation. • 100 % ≙ Motor rated torque 0x6076 (P325.00)

Next steps

- The inverter provides different functions by means of which the drive behaviour can be further optimised. ▶ [Optimisation of motor control](#) [154](#)
- The default setting enables the operation of a power-adapted motor. **An optimum operation of this motor control type requires an optimisation of the control loops!** ▶ [Optimisation of the control loops](#) [165](#)



Motor control

Motor control selection
Sensorless control for synchronous motors (SL-PSM)

7.2.5.1 Stall monitoring

The stalling monitoring for the sensorless control for synchronous motors (SL-PSM) switches off the drive if the motor is about to "stall". A possible cause may be an overload of the motor.

Preconditions

The stalling monitoring only works in the controlled area and if the motor is not operated in the field weakening range.

Details

In order to detect the motor stalling, the cosine phi is used.

Example:

- For the cosine phi, the value "0.9" is set in [0x2C01:008 \(P320.08\)](#) according to the data given on the motor nameplate.
- The limit value for stalling monitoring is set in [0x2C11:006](#) to "80 %".
- Stalling monitoring is triggered if the current cosine phi is lower than 0.72 (80 % of 0.9).



If stalling monitoring is triggered, the "Trouble" error response takes place. If the operating mode "MS: Velocity mode [-2]" is set in [0x6060 \(P301.00\)](#), the motor automatically restarts if the trouble does not exist anymore.

Parameter	Name / value range / [default setting]	Info
0x2C11:006	High speed range: Stall monitoring limit 0 ... [80] ... 65535 % • From version 04.00	The stall monitoring limit refers to the cosine phi of the motor in percent.
0x6060 (P301.00)	Modes of operation (Modes of op.) • Setting can only be changed if the inverter is inhibited.	Selection of the operating mode.
	-2 MS: Velocity mode	Vendor specific velocity mode
	-1 MS: Torque mode (from version 03.00)	Vendor specific torque mode • Only possible in motor control type 0x2C00 (P300.00) = "Sensorless vector control (SLVC) [4]". ▶ Torque control w/ freq. limit □ 179
	0 No mode change/no mode assigned	No operating mode (standstill)
	2 CiA: Velocity mode	CiA 402 velocity mode

Motor control

Optimisation of motor control
Sensorless control for synchronous motors (SL-PSM)



7.3 Optimisation of motor control



The inverter provides different functions by means of which the drive behaviour can be further optimised.

Function	Motor control type				
	VFC open loop	VFC closed loop	SC-ASM	SL-PSM	SLVC
V/f voltage boost □ 155 The parameterisable voltage boost makes it possible to improve the starting performance for applications requiring a high starting torque.	●	●			
Skip frequencies □ 156 By means of the three parameterisable skip frequencies, critical frequencies can be suppressed which lead to mechanical resonances in the system.	●	●	●	●	●
Optimising the stalling behaviour □ 158 For special motors which enable an operation in the field weakening range, the behaviour in the field weakening range can be adapted to the motor.	●	●			
Slip compensation □ 160 In case of a load, the speed of an asynchronous motor decreases. This load-dependent speed drop is called slip. The slip compensation serves to counteract the load-dependent speed loss.	●				
Oscillation damping □ 162 The oscillation damping serves to reduce the oscillations during no-load operation which are caused by energy oscillating between the mechanical system (mass inertia) and the electrical system (DC bus).	●	●			
Synchronous motor: Pole position identification (PPI) □ 163 For controlling a permanent-magnet synchronous motor, the pole position - the angle between the motor phase U and the field axis of the rotor - must be known. This function serves to detect the pole position for the currently activated motor encoder.				●	
VFC open loop = V/f characteristic control VFC closed loop = V/f characteristic control with speed feedback SC-ASM = servo control for asynchronous motor SL-PSM = sensorless control for synchronous motor SLVC = sensorless vector control					



7.3.1 V/f voltage boost

The parameterisable voltage boost makes it possible to improve the starting performance for applications requiring a high starting torque.

Preconditions

The function is only effective in the following motor control types:

- V/f characteristic control (VFC open loop)
- V/f characteristic control (VFC closed loop)

Details

- In [0x2B12:001 \(P316.01\)](#), a permanent voltage boost can be set. ①
- In [0x2B12:002 \(P316.02\)](#), an additional voltage boost can be set for acceleration processes only. ②
- Reference for the percentage setting of the voltage boost is the base voltage [0x2B01:001 \(P303.01\)](#).

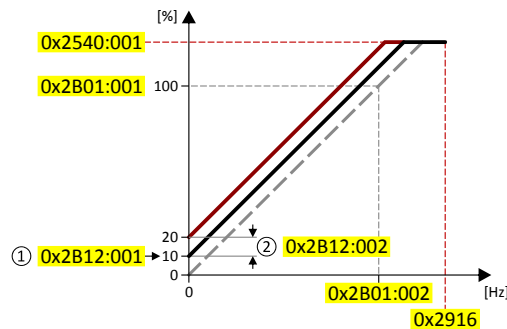

Parameter	Name / value range / [default setting]	Info
0x2B12:001 (P316.01)	Fixed boost (Fixed V/f boost) 0.0 ... [2.5]* ... 20.0 % * Default setting depending on the size.	Fixed (constant) voltage boost for V/f characteristic control without feedback. <ul style="list-style-type: none"> • 100 % \equiv V/f base voltage 0x2B01:001 (P303.01) • For the purpose of optimising the starting performance for applications requiring a high starting torque.
0x2B12:002 (P316.02)	V/f voltage boost: Boost at acceleration (V/f boosts: Dynam. V/f boost) 0.0 ... [0.0] ... 20.0 %	Additional voltage boost for V/f characteristic control without feedback. <ul style="list-style-type: none"> • 100 % \equiv V/f base voltage 0x2B01:001 (P303.01) • This voltage boost is only active while the motor is accelerated. It then acts in addition to the fixed voltage boost set in 0x2B12:001 (P316.01).
0x2B01:001 (P303.01)	V/f shape data: Base voltage (V/f shape data: Base voltage) 0 ... [230]* ... 5000 V * Default setting depending on the size.	Base voltage and base frequency define the V/f ratio and thus the gradient of the V/f characteristic. <ul style="list-style-type: none"> • The V/f base voltage is usually set to the rated motor voltage 0x2C01:007 (P320.07). • The V/f base frequency is usually set to the rated motor frequency 0x2C01:005 (P320.05).
0x2B01:002 (P303.02)	V/f shape data: Base frequency (V/f shape data: Base frequency) Device for 50-Hz mains: 0 ... [50]* ... 1500 Hz Device for 60-Hz mains: 0 ... [60]* ... 1500 Hz * Default setting depending on the size.	

Motor control

Optimisation of motor control
Skip frequencies

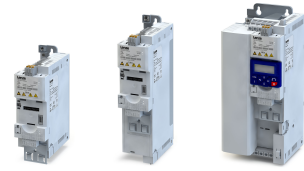

7.3.2 Skip frequencies

By means of the three parameterisable skip frequencies, critical frequencies can be suppressed which lead to mechanical resonances in the system.

Details

A blocking zone is active as soon as the frequency for this blocking zone is set to value unequal to "0 Hz".

- The set frequency defines the centre of the range to be masked out. ①
- The set bandwidth defines its total size. ②

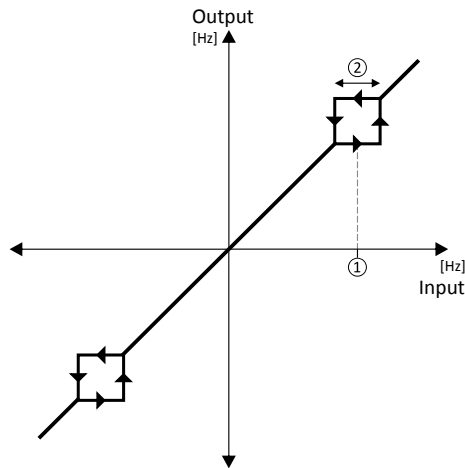

Example: For a blocking zone, the frequency is set to 20 Hz and the bandwidth to 10 Hz. These settings mask out the range from 15 Hz to 25 Hz.

Notes:

- Skip frequencies are absolute values. With the setting "20 Hz", at the same time also the skip frequency "-20 Hz" is defined.
- The inverter accelerates/decelerates the motor by the range to be masked out. A continuous operation within this range is not possible.
- A blocking zone is not active if its bandwidth is set to "0 Hz".

Adjacent and overlapping ranges:

- Example on the left: If the ranges are closely spaced, the ranges are passed through as shown.
- Example on the right: If the ranges overlap, the lowest and highest value form a new range. In the status display `0x291F:016`, both ranges are shown as active.

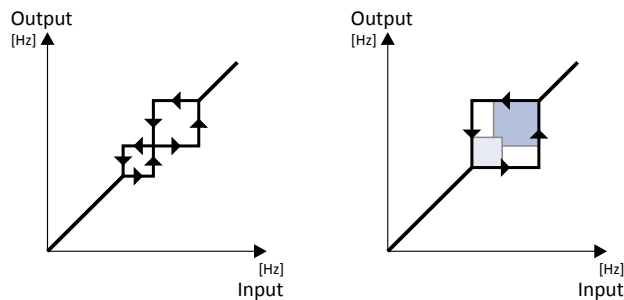



Valid and invalid ranges:

- Example on the left: Skip frequency = 5 Hz, bandwidth = 10 Hz
→ Valid range (starts at ≥ 0)
- Example on the right: Skip frequency = 4 Hz, bandwidth = 10 Hz
→ Invalid range (starts at < 0); is thus ignored.

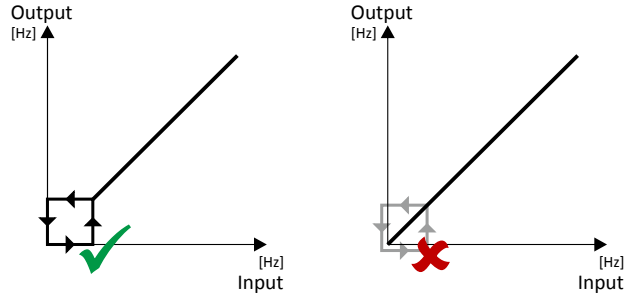

Parameter	Name / value range / [default setting]	Info
0x291F:001 (P317.01)	Skip frequencies: Skip frequency 1 (Skip frequencies: Skip frequency 1) 0.0 ... [0.0] ... 599.0 Hz	Centre of frequency range 1 which is to be skipped.
0x291F:002 (P317.02)	Skip frequencies: Skip bandwidth 1 (Skip frequencies: Skip bandwidth 1) 0.0 ... [0.0] ... 10.0 Hz	Size of frequency range 1 which is to be skipped.
0x291F:003 (P317.03)	Skip frequencies: Skip frequency 2 (Skip frequencies: Skip frequency 2) 0.0 ... [0.0] ... 599.0 Hz	Centre of frequency range 2 which is to be skipped.
0x291F:004 (P317.04)	Skip frequencies: Skip bandwidth 2 (Skip frequencies: Skip bandwidth 2) 0.0 ... [0.0] ... 10.0 Hz	Size of frequency range 2 which is to be skipped.
0x291F:005 (P317.05)	Skip frequencies: Skip frequency 3 (Skip frequencies: Skip frequency 3) 0.0 ... [0.0] ... 599.0 Hz	Centre of frequency range 3 which is to be skipped.
0x291F:006 (P317.06)	Skip frequencies: Skip bandwidth 3 (Skip frequencies: Skip bandwidth 3) 0.0 ... [0.0] ... 10.0 Hz	Size of frequency range 3 which is to be skipped.
0x291F:016	Skip frequencies: Status • Read only	Bit-coded status display of the skip frequencies.
	Bit 0 Blocking zone 1 active	
	Bit 1 Blocking zone 2 active	
	Bit 2 Blocking zone 3 active	
	Bit 4 Frequency above blocking zone 1	
	Bit 5 Frequency above blocking zone 2	
	Bit 6 Frequency above blocking zone 3	
	Bit 8 Blocking zone 1 invalid	
	Bit 9 Blocking zone 2 invalid	
	Bit 10 Blocking zone 3 invalid	
0x291F:032	Skip frequencies: Input frequency • Read only: x.xx Hz	Display of the skip filter input frequency.
0x291F:033	Skip frequencies: Output frequency • Read only: x.xx Hz	Display of the skip filter output frequency.

Motor control

Optimisation of motor control
Optimising the stalling behaviour



7.3.3 Optimising the stalling behaviour

If the motor is driven with frequencies above the rated motor frequency, the operating point is shifted to the "field weakening range". In this range, the motor voltage does not increase proportionately to the output frequency anymore. As a consequence, the inverter automatically reduces the maximum current since the full torque is not available anymore at these frequencies.

For special motors which enable an operation in the field weakening range, the behaviour in the field weakening range can be adapted to the motor with [0x2B0C \(P319.00\)](#).

DANGER!

Danger by incorrect parameterisation.

Possible consequences: damage to material assets and injury to persons

- ▶ Only change the default setting (0 Hz) in [0x2B0C \(P319.00\)](#) after consulting the motor manufacturer!
- ▶ Recommendation: Maintain default setting (0 Hz).

Preconditions

The function is only effective in the following motor control types:

- V/f characteristic control (VFC open loop)
- V/f characteristic control (VFC closed loop)



Details

The operating range of an asynchronous motor consists of the voltage range ① and the field weakening range. The field weakening range again is divided into two ranges:

- In the first range ②, the power can be kept constant without the motor stalling.
- The second field weakening range ③ is characterised by the fact that the maximum permissible stator current is decreased to prevent the motor from stalling.

Speed/torque curve of the asynchronous motor with two field weakening ranges

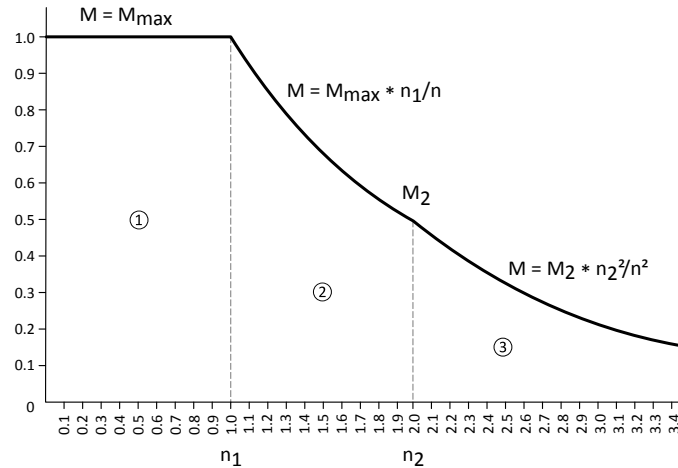

The override point (n_2, M_2) can be influenced with [0x2B0C \(P319.00\)](#).

[0x2B0C \(P319.00\)](#) > 0 Hz:

- The maximum current characteristic is shifted to higher field frequencies by the frequency entered.
- The maximum permissible current and the maximum torque increase in the field weakening range.
- The risk of motor stalling increases.

[0x2B0C \(P319.00\)](#) < 0 Hz:

- The maximum current characteristic is shifted to lower field frequencies by the frequency entered.
- The maximum permissible current and the maximum torque are reduced in the field weakening range.
- The risk of motor stalling is reduced.

Parameter	Name / value range / [default setting]	Info
0x2B0C (P319.00)	Override field weakening (Field weak thold) -599.0 ... [0.0] ... 599.0 Hz	Offset of the override point for field weakening.
0x2B01:002 (P303.02)	V/f shape data: Base frequency (V/f shape data: Base frequency) Device for 50-Hz mains: 0 ... [50]* ... 1500 Hz Device for 60-Hz mains: 0 ... [60]* ... 1500 Hz * Default setting depending on the size.	Base voltage and base frequency define the V/f ratio and thus the gradient of the V/f characteristic. <ul style="list-style-type: none"> • The V/f base voltage is usually set to the rated motor voltage 0x2C01:007 (P320.07). • The V/f base frequency is usually set to the rated motor frequency 0x2C01:005 (P320.05).

Motor control

Optimisation of motor control
Slip compensation



7.3.4 Slip compensation

In case of a load, the speed of an asynchronous motor decreases. This load-dependent speed drop is called slip. The slip compensation serves to counteract the load-dependent speed loss.

Preconditions

The function is only effective in the motor control type "V/f characteristic control (VFC open loop)".

In order that the function can determine the rated slip correctly, the following parameters must be set correctly:

- Rated speed
- Rated frequency
- Number of pole pairs (automatically calculated from Rated speed and Rated frequency)

Details

The slip compensation increases or decreases the output frequency as a response to a load change. Thus, the slip is counteracted and the speed is kept precisely.

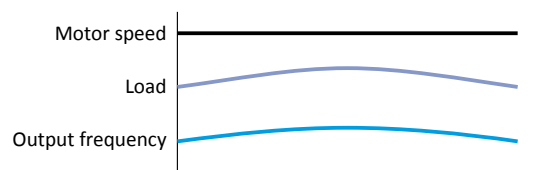

The rated slip required for the slip compensation is calculated by the inverter according to the following formula:

$$\text{Rated slip [\%]} = (1 - (\text{rated motor speed [rpm]} / (120 * \text{rated motor frequency [Hz]} / \text{number of poles}))) * 100$$

Calculation example:

- Rated motor speed = 1750 rpm
- Rated motor frequency = 60 Hz
- Number of poles = 2 * Number of pole pairs = 2 * 2 = 4
- Rated slip = $(1 - (1750 / (120 * 60 / 4))) * 100 = 2.77 \%$

The rated slip represents the reduction of the motor speed due to the motor load. At full speed and full load, the motor given in the example would rotate with 1750 rpm, which means 2.77 % below its synchronous speed of 1800 rpm. In order to compensate this speed loss, the inverter increases the output frequency by the rated slip multiplied by the rated motor frequency. In the example $2.77 \% * 60 \text{ Hz} = 1.66 \text{ Hz}$ increase at full load.

In order to consider load changes, the influence of the rated slip on output frequency can be adapted in [0x2B09:001 \(P315.01\)](#). A setting of 100 % corresponds to the rated slip of the machine in the nominal operating point.

With reference to the example above and a setpoint frequency of 60 Hz:

- If [0x2B09:001 \(P315.01\)](#) = 100 %, the output frequency is = 61.66 Hz (60 Hz + 100 % * 1.66 Hz).
- If [0x2B09:001 \(P315.01\)](#) = 50 %, the output frequency is = 60.83 Hz (60 Hz + 50 % * 1.66 Hz).

Additionally, the filter time for the slip compensation can be adapted in [0x2B09:002 \(P315.02\)](#) if required. The preset filter time is adapted to typical motors. If full load or nearly full load oscillations or instabilities occur, we recommend an increase of the filter time.

Parameter	Name / value range / [default setting]	Info
0x2B09:001 (P315.01)	Slip compensation: Gain (Slip compens.: Slip: gain) -200.00 ... [100.00] ... 200.00 %	Adjustment in percent of the slip calculated. <ul style="list-style-type: none">• For instance required for deviations of the real motor data from the nameplate data.• A setting of 100 % corresponds to the rated slip of the machine in the nominal operating point.
0x2B09:002 (P315.02)	Slip compensation: Filter time (Slip compens.: Filter time) 1 ... [5] ... 6000 ms	Filter time for the slip compensation. <ul style="list-style-type: none">• The preset filter time is adapted to typical motors.



Motor control

Optimisation of motor control

Slip compensation

Parameter	Name / value range / [default setting]	Info
0x2C02:004 (P351.04)	Slip frequency (Slip frequency) • Read only: x.x Hz	Display of the rated slip determined.
0x2C01:001	Motor parameters: Number of pole pairs • Read only	Display of the number of pole pairs calculated from the rated speed and rated frequency.
0x2C01:004 (P320.04)	Motor parameters: Rated speed (Motor parameters: Rated speed) Device for 50-Hz mains: 50 ... [1450] ... 50000 rpm Device for 60-Hz mains: 50 ... [1750] ... 50000 rpm	General motor data. Carry out settings as specified by motor nameplate data. Note!
0x2C01:005 (P320.05)	Motor parameters: Rated frequency (Motor parameters: Rated frequency) Device for 50-Hz mains: 1.0 ... [50.0] ... 1000.0 Hz Device for 60-Hz mains: 1.0 ... [60.0] ... 1000.0 Hz	When you enter the motor nameplate data, take into account the phase connection implemented for the motor (star or delta connection). Only enter the data applying to the connection type selected.

Motor control

Optimisation of motor control
Oscillation damping



7.3.5 Oscillation damping

The oscillation damping serves to reduce the oscillations during no-load operation which are caused by energy oscillating between the mechanical system (mass inertia) and the electrical system (DC bus). Furthermore, the oscillation damping can also be used to compensate for resonances.

Preconditions

The function is only effective in the following motor control types:

- V/f characteristic control (VFC open loop)
- V/f characteristic control (VFC closed loop)

Restrictions

Observe the following restrictions:

- Damping is possible only for constant oscillations at a steady-state operating point.
- Oscillations occurring sporadically cannot be damped.
- Oscillation damping is not suitable for oscillations occurring during dynamic processes (e.g. accelerations or load changes).
- Oscillation damping is only active if the setpoint speed is greater than 10 rpm and the DC-bus voltage exceeds a value of 100 V.

Details

The determination of the oscillation is based on the active current. In order to obtain the alternating component of the active current, this current is differentiated. This signal is then passed through a PT1 filter.

Identification of the oscillation

Before the oscillation damping function can be parameterised, the oscillation has to be identified. One way to do this is to examine the motor current while oscillation damping is switched off (gain = 0 %). At steady-state operation, a constant current flows. If the drive oscillates, these oscillations are also visible on the motor current. It is therefore possible to determine the frequency and the amplitude of the oscillation from the alternating component of the motor current. In the following, this alternating component is referred to as "current oscillation".

Parameter setting

The gain of the oscillation signal is to be set according to the following equation:

$$0x2B0A:001 \text{ (P318.01)} = \text{current amplitude} * 100 \% / (\sqrt{2} * \text{maximum device current})$$

The default time constant of the PT1 filter should be sufficient for most applications. If required, it is only possible to adapt the time constant via »EASY Starter«. Generally, the time constant must be set so that the oscillation can be dampened, but that higher-frequency components are filtered from the signal. The time constant is determined from the reciprocal value of the double current oscillation frequency:

$$0x2B0A:002 \text{ (P318.02)} = 1 / (2 * \text{oscillation frequency})$$

Parameter	Name / value range / [default setting]	Info
0x2B0A:001 (P318.01)	Gain (Gain) -100 ... [20] ... 100 %	Gain of the oscillation signal. <ul style="list-style-type: none">• With the setting 0, oscillation damping is deactivated.
0x2B0A:002 (P318.02)	Filter time (Filter time) 1 ... [5] ... 600 ms	Time constant of the PT1 filter.
0x2DDF:002	Axis information: Maximum current <ul style="list-style-type: none">• Read only: x.xx A	Display of the maximum current of the axis.
0x2D88 (P104.00)	Motor current (Motor current) <ul style="list-style-type: none">• Read only: x.x A	Display des present current-r.m.s. value.



7.3.6 Synchronous motor: Pole position identification (PPI)

If a permanent-magnet synchronous motor is operated at the inverter, the inverter can be configured in such a way that a "pole position identification (PLI)" is executed after every inverter enable.

Preconditions

In [0x2C00 \(P300.00\)](#) the motor control type "Sensorless control (SL PSM) [3]" is selected.

Details

The pole position is the angle between the motor phase U and the field axis of the rotor.

The "[Pole position identification \(PPI\) without movement](#)" function is available for the inverter i5xx for identifying the pole position. For details see the following subchapters. [164](#)

If an error occurs during the pole position identification,

- the procedure is stopped without the settings being changed.
- the response set in [0x2C60](#) is effected.

Parameter	Name / value range / [default setting]	Info
0x2C60	PPI monitoring: Reaction <ul style="list-style-type: none"> • From version 04.00 • For further possible settings, see parameter 0x2D45:001 (P310.01). 196 	Selection of the response triggered by the occurrence of an error during the pole position identification (PLI). Associated error code: <ul style="list-style-type: none"> • 28961 0x7121 - Pole position identification fault
	3 Fault	Error types 113

Motor control

Optimisation of motor control

Synchronous motor: Pole position identification (PPI)



7.3.6.1 Pole position identification (PPI) without movement

This function was developed for a wide range of motor characteristics. In case of some motor types, the identified pole position may differ considerably from the real pole position, so that a considerable loss in torque and greater motor losses may occur. The function can also be used if the motor cannot rotate (holding brake is active).

i NOTICE

With an incorrect parameter setting and dimensioning of the inverter, the maximum permissible motor current may be exceeded during the pole position identification.

Possible consequence: irreversible damage of the motor.

- ▶ Set the motor data correctly. ▶ [Motor data](#) 137
- ▶ Only use an inverter that is performance-matched to the motor.

Preconditions

- The wiring of the three motor phases and the motor encoder must be carried out according to the specifications from the mounting instructions.
- The inverter is ready for operation (no fault active).
- For the pole position identification (PPI) without movement, the motor must be at standstill. In order that the pole position identification is only executed at standstill, set the Start method "Flying restart circuit [2]" in [0x2838:001 \(P203.01\)](#).

Details

In order that the pole position identification can be executed automatically after every inverter enable, select "After each enable [2]" in [0x2C63:001](#). Further settings are not required for this function.

Process of the pole position identification:

1. After inverter enable, a defined pulse pattern is output that provides currents up to approx. maximum motor current. The respective currents are measured. Based on these currents, the field distribution can be detected so that the pole position can be calculated.
2. After the pole position identification has been carried out successfully, the motor follows the setpoint selection.

During the pole position identification:

- The current test pulses cause audible engine noises that may be increased by the machine mechanics depending on the mechanical coupling!
- The function can be aborted by the inverter disable any time without changing the settings. In this case, you have to carry out the pole position identification again.
- If the function is aborted by itself, the motor features may not be suitable for this function.

Parameter	Name / value range / [default setting]	Info
0x2C63:001	PPI without movement: Execution <ul style="list-style-type: none">• Setting can only be changed if the inverter is inhibited.• From version 04.00	Starting performance (without or with pole position identification before the start).
	0 Deactivated	Do not execute a pole position identification.
	2 After each enable	Execute a pole position identification after every inverter enable.



7.4 Optimisation of the control loops

Setting of motor data

Motor control selection

Optimisation of motor control

Optimisation of the control loops

If there is a need to improve the total power of the system, different options are available:

- a) Select motor from motor catalogue
- b) Tuning of the motor and the speed controller
- c) Automatic motor identification (energized)
- d) Automatic motor calibration (non-energized)

Simply select an option that best suits your environment and requirements!

Before the different options are described in detail, first make the decision which operator interface you want to use to execute the optimisation:

Option 1: [Performing optimisation with engineering tool](#)  166

Option 2: [Performing optimisation with keypad](#)  167

Motor control

Optimisation of the control loops

Synchronous motor: Pole position identification (PPI)



Performing optimisation with engineering tool

The following flow diagram shows the optimisation process with an engineering tool (e. g. »EASY Starter«):

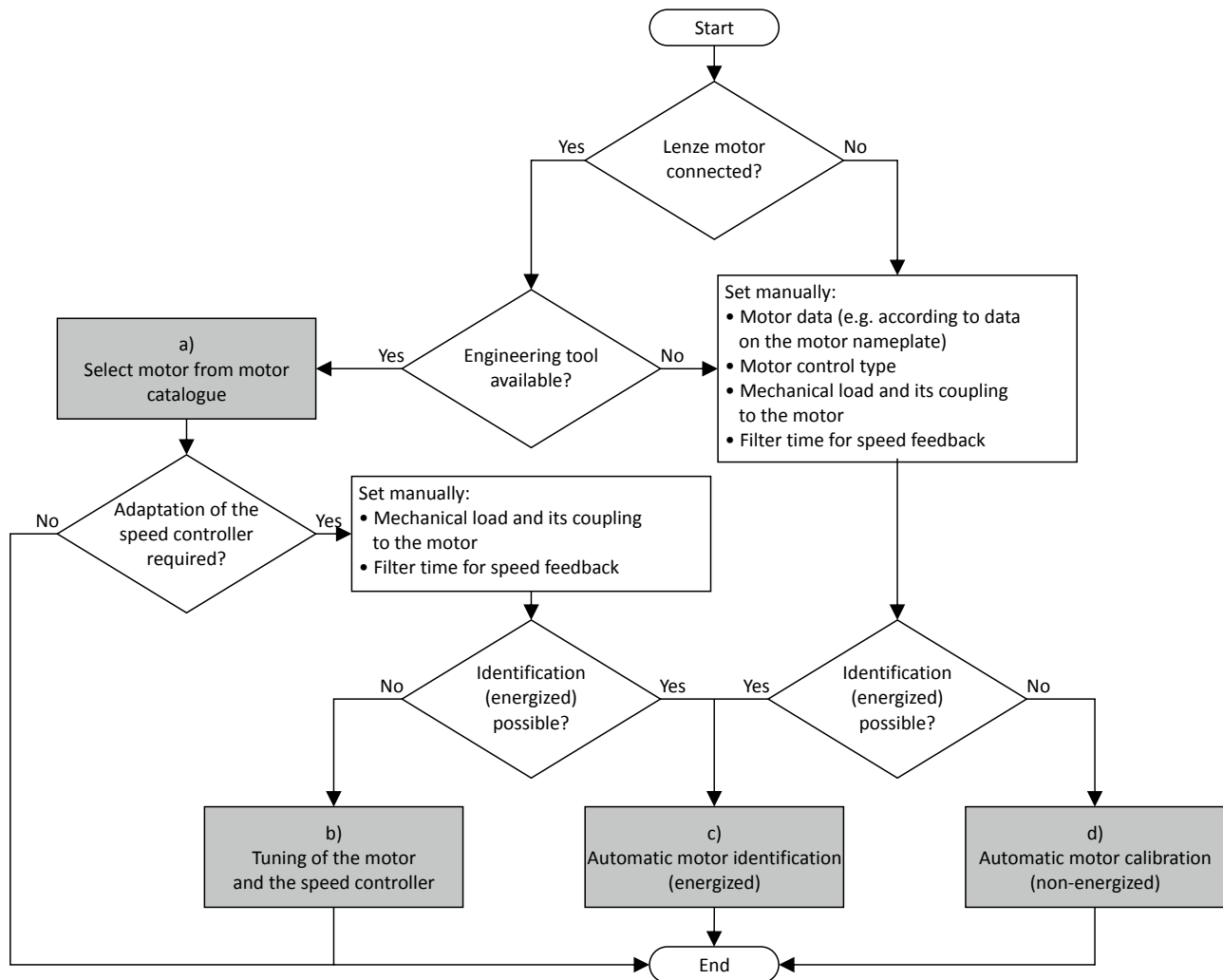

- No matter which option suits you best, first the relevant motor data must be set. By selecting the motor from the motor catalogue, you benefit from very accurate Motor equivalent circuit diagram data.
▶ [Motor selection from motor catalogue](#) 169
- If you already have an optimised system, but the load adjustment has changed, it makes sense to just re-initialise the speed controller.
▶ [Tuning of the motor and the speed controller](#) 170
- If the application enables you to energise the system during the optimisation procedure, carry out an automatic identification. This procedure results in the best possible parameter settings.
▶ [Automatic motor identification \(energized\)](#) 171
- If the application does **not** enable you to energise the system during the optimisation procedure, carry out an automatic calibration.
▶ [Automatic motor calibration \(non-energized\)](#) 172



Performing optimisation with keypad

Since there is no access with the keypad to the motor catalogue, first the motor data must be set manually with the keypad according to the manufacturer data/motor data sheet. ▶ [Manual setting of the motor data](#) [137](#)

The following flow diagram shows the optimisation process with the keypad:

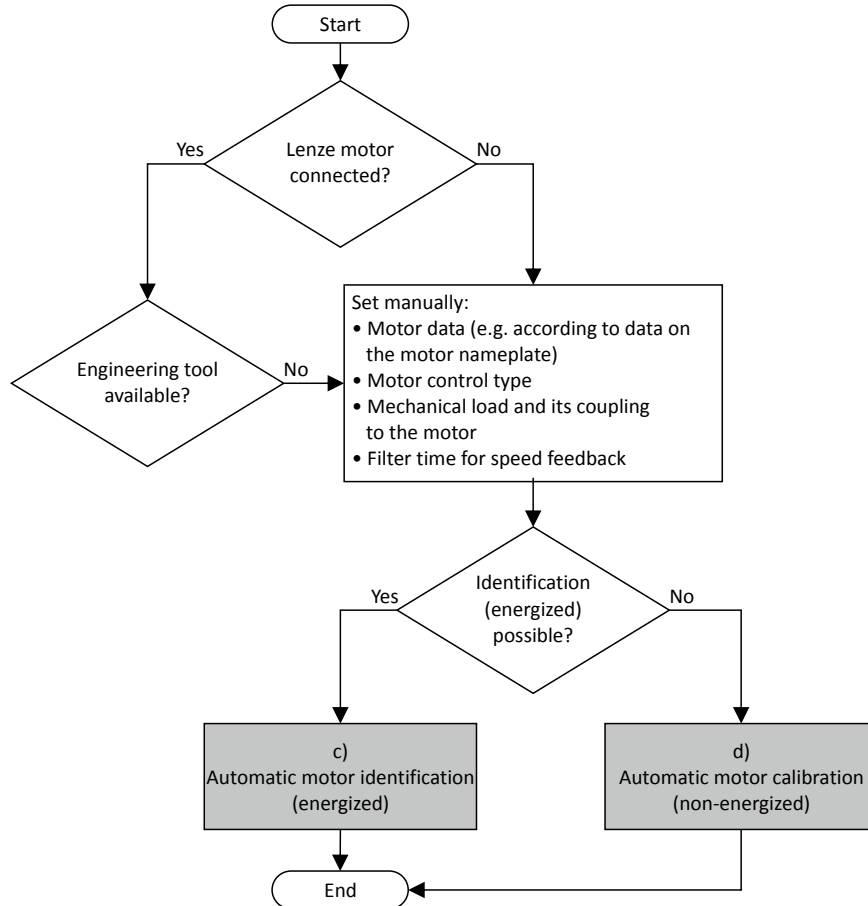

- c) If the application enables you to energise the system during the optimisation procedure, carry out an automatic identification. This procedure results in the best possible parameter settings.
▶ [Automatic motor identification \(energized\)](#) [171](#)
- d) If the application does **not** enable you to energise the system during the optimisation procedure, carry out an automatic calibration.
▶ [Automatic motor calibration \(non-energized\)](#) [172](#)

Motor control

Optimisation of the control loops
Options for optimized motor tuning

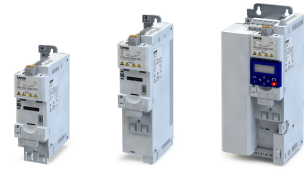

7.4.1 Options for optimized motor tuning

The option to be selected depends on the respective application. Depending on the selected option, different procedures become active and thus different parameter groups are influenced:

- Rated motor data
- Inverter characteristic
- Motor equivalent circuit diagram data
- Motor controller settings
- Speed controller settings

For further details, see the following subchapters:

- [Motor selection from motor catalogue](#) 169
- [Tuning of the motor and the speed controller](#) 170
- [Automatic motor identification \(energized\)](#) 171
- [Automatic motor calibration \(non-energized\)](#) 172



7.4.1.1 Motor selection from motor catalogue

The following describes how to optimise your drive system by selecting a Lenze motor from the motor catalogue. Several steps are started invisibly in the background to load/calculate the settings for the relevant parameters.

Preconditions

- Access to a Lenze engineering tool (e. g. »EASY Starter«).
- Optimisation is possible online or offline (with or without connected motor).

Required steps

1. Open the Lenze engineering tool that provides for the functionality of a "Lenze motor catalogue".
2. Click the **Select motor...** button. In case of the »EASY Starter«, you find the **Select motor...** button on the "settings". tab.
3. Select the used motor in the "Select motor" dialog:

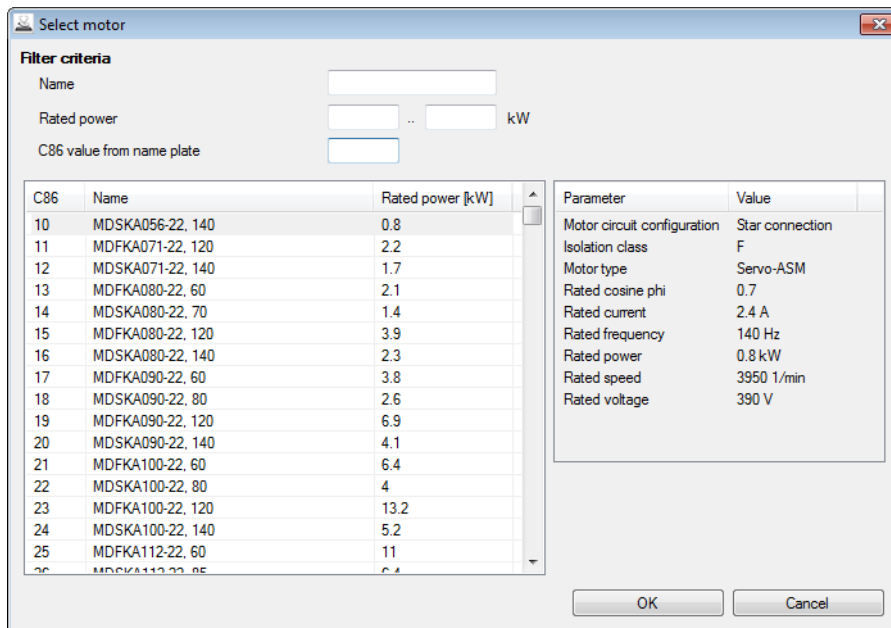

- By entering filter criteria, you can restrict the selection.
 - Name (e. g. "MDSKxxx"), rated power and C86 value can be found on the motor name-plate.
4. Click the **OK** button to start the optimisation.

Optimisation process

As soon as the optimisation has been started, the following steps are initiated by the engineering tool:

1. The rated motor data are loaded from the motor catalogue.
2. The motor equivalent circuit diagram data are loaded from the motor catalogue.
3. The motor controller settings are calculated based on the previously loaded data.
4. The speed controller settings are automatically calculated based on the previously loaded data.

Notes:

- The data involved in this optimisation are provided by the motor catalogue alone. Further user data is not required.
- The inverter characteristic is not changed by this optimisation.

Parameter	Name / value range / [default setting]	Info
0x2C01:010	Motor parameters: Motor name	The name (e.g. " 1") can be freely selected by the user. If the motor in the engineering tool has been selected from the "motor catalog", the respective motor name is automatically entered here (example: "MDSKA080-22, 70").

Motor control

Optimisation of the control loops
Options for optimized motor tuning







7.4.1.2 Tuning of the motor and the speed controller

The following describes in general how to optimise the speed controller. This may be required if some parameters have on the load side of the drive system have changed or have not been set yet, such as:

- Motor moment of inertia
- Load moment of inertia
- Type of coupling between moment of inertia of the motor and that of the load

Preconditions

- All rated motor data are known and set in the inverter, either by selecting the motor from the motor catalogue or manually.
 - ▶ [Motor selection from motor catalogue](#)  169
 - ▶ [Manual setting of the motor data](#)  137
- All further options for optimisation have been executed before if possible.
 - ▶ [Automatic motor identification \(energized\)](#)  171
 - ▶ [Automatic motor calibration \(non-energized\)](#)  172
- Optimisation is possible online or offline (with or without connected motor).

Required steps

Adapt the following parameters to your drive system using the engineering tool. Since this only changes load-dependent data, the other parameter groups must not be calculated again.

Parameter	Name / value range / [default setting]	Info
0x2910:001 (P335.01)	Motor moment of inertia (Motor inertia) 0.00 ... [3.70] * ... 20000000.00 kg cm ² * Default setting depending on the size.	Setting of the moment of inertia of the motor.
0x2910:002 (P335.02)	Load moment of inertia (Load inertia) 0.00 ... [3.70] * ... 20000000.00 kg cm ² * Default setting depending on the size.	Setting of the moment of inertia of the load. <ul style="list-style-type: none">• Always adjust the setting to the current load, otherwise the optimisation process cannot be executed successfully.
0x2910:003	Coupling 0 Stiff 1 Elastic 2 With backlash	Selection of the type of coupling between the moment of inertia of the motor and that of the load.
0x2904	Actual speed filter time 0.0 ... [2.0] ... 50.0 ms	Filter time for the actual speed value.

For further details on the speed controller, see chapter "[Speed controller](#)".  184



7.4.1.3 Automatic motor identification (energized)

The automatic identification of the motor results in the best possible parameter settings. If the application enables you to energise the system during the optimisation, carry out this optimisation.

Preconditions

- All rated motor data are known and set in the inverter, either by selecting the motor from the motor catalogue or manually.
 - ▶ [Motor selection from motor catalogue](#) [169](#)
 - ▶ [Manual setting of the motor data](#) [137](#)
- In [0x2C00 \(P300.00\)](#), the motor control type required and suitable for the motor is selected.
- In [0x6060 \(P301.00\)](#), the operating mode "MS: Velocity mode [-2]" or "CiA: Velocity mode [2]" is set.
- DC-bus voltage is available.
- The inverter is error-free and in the "Ready to switch on" or "Switched on" device state.
- The motor is stopped (no start enable).
- No inverter disable is active.
- No quick stop is active.
- No other axis command is active anymore.

General information on the identification

- The automatic identification can take from some seconds to minutes.
- The procedure can be aborted any time by inverter disable or cancellation of the start enable without settings being changed.
- During and after the procedure, the LED "RDY" (blue) is permanently on.
- After completing, a renewed start command is required to start the motor.

Required steps

Optimisation with engineering tool (e. g. »EASY Starter«):

1. Go to the "Settings" tab and navigate to the parameterisation dialog "Advanced motor setting".
2. Click the **Energized** button under "motor calibration".
3. Follow the instructions of the engineering tool.

Optimisation with keypad:

1. Request automatic identification: Set [0x2822:004 \(P327.04\)](#) = "1".
2. Issue the start command to start the procedure.

Parameter	Name / value range / [default setting]	Info
0x2822:004 (P327.04)	Identify motor data (energized) (Identify mot.) 0 ... [0] ... 1	1 = start automatic identification of the motor data. • Inverter characteristics, motor equivalent circuit diagram data and controller settings are identified and set automatically. • During the procedure, the motor is energised!

Optimisation process

As soon as the process has been started, the following steps are initiated:

1. The inverter characteristic is automatically identified by the inverter.
2. The motor equivalent circuit diagram data are automatically identified by the inverter.
3. The motor controller settings are automatically calculated.
4. The speed controller settings are automatically calculated.

Motor control

Optimisation of the control loops
Options for optimized motor tuning



7.4.1.4 Automatic motor calibration (non-energized)

If the application does not enable you to energise the system during the optimisation, carry out this optimisation.

Preconditions

- All rated motor data are known and set in the inverter, either by selecting the motor from the motor catalogue or manually.
 - ▶ [Motor selection from motor catalogue](#) [169](#)
 - ▶ [Manual setting of the motor data](#) [137](#)
- In [0x2C00 \(P300.00\)](#), the motor control type required and suitable for the motor is selected.
- The inverter is error-free and in the "Ready to switch on" or "Switched on" device state.
- The inverter is disabled or the motor is stopped (no start enable).
- No other axis command is active anymore.

Required steps

Optimisation with engineering tool (e. g. »EASY Starter«):

1. Go to the "Settings" tab and navigate to the parameterisation dialog "Advanced motor setting".
2. Click the **Non-energized** button under "motor calibration".
3. Follow the instructions of the engineering tool.

Optimisation with keypad:

- [0x2822:005 \(P327.05\)](#)Set = "1" to start the process.

Parameter	Name / value range / [default setting]	Info
0x2822:005 (P327.05)	Calibrate motor data (non-energized) (Calibrate mot.) 0 ... [0] ... 1	1 = start automatic calibration of the motor data. <ul style="list-style-type: none">• A default inverter characteristic is loaded.• the motor equivalent circuit diagram data and controller settings are calculated on the basis of the currently set rated motor data.• The motor is not energised.

Optimisation process

As soon as the process has been started, the following steps are initiated:

1. A default inverter characteristic is loaded.
2. The motor equivalent circuit diagram data is calculated based on the currently set rated motor data.
3. The motor controller settings are automatically calculated.
4. The speed controller settings are automatically calculated.



7.4.2 Inverter Characteristics

The inverter characteristic is automatically set if one of the following optimisations is carried out:

- ▶ [Automatic motor identification \(energized\)](#) 171
- ▶ [Automatic motor calibration \(non-energized\)](#) 172



The settings made can be seen if required, but should not be changed. A wrong setting may influence the control negatively!

Parameter	Name / value range / [default setting]	Info
0x2947:001	Inverter characteristic: Value y1 0.00 ... [0.00]* ... 20.00 V * Default setting depending on the size.	<p>The inverter characteristic (consisting of 17 values) is calculated and set during the automatic identification of the motor data. If only an automatic calibration of the motor data is carried out, a default inverter characteristic is loaded instead.</p> <p>Note! Changing these values is not recommended by the manufacturer.</p>
0x2947:002	Inverter characteristic: Value y2 0.00 ... [0.00]* ... 20.00 V * Default setting depending on the size.	
0x2947:003	Inverter characteristic: Value y3 0.00 ... [0.00]* ... 20.00 V * Default setting depending on the size.	
0x2947:004	Inverter characteristic: Value y4 0.00 ... [0.00]* ... 20.00 V * Default setting depending on the size.	
0x2947:005	Inverter characteristic: Value y5 0.00 ... [0.00]* ... 20.00 V * Default setting depending on the size.	
0x2947:006	Inverter characteristic: Value y6 0.00 ... [0.00]* ... 20.00 V * Default setting depending on the size.	
0x2947:007	Inverter characteristic: Value y7 0.00 ... [0.00]* ... 20.00 V * Default setting depending on the size.	
0x2947:008	Inverter characteristic: Value y8 0.00 ... [0.00]* ... 20.00 V * Default setting depending on the size.	
0x2947:009	Inverter characteristic: Value y9 0.00 ... [0.00]* ... 20.00 V * Default setting depending on the size.	
0x2947:010	Inverter characteristic: Value y10 0.00 ... [0.00]* ... 20.00 V * Default setting depending on the size.	
0x2947:011	Inverter characteristic: Value y11 0.00 ... [0.00]* ... 20.00 V * Default setting depending on the size.	
0x2947:012	Inverter characteristic: Value y12 0.00 ... [0.00]* ... 20.00 V * Default setting depending on the size.	
0x2947:013	Inverter characteristic: Value y13 0.00 ... [0.00]* ... 20.00 V * Default setting depending on the size.	
0x2947:014	Inverter characteristic: Value y14 0.00 ... [0.00]* ... 20.00 V * Default setting depending on the size.	
0x2947:015	Inverter characteristic: Value y15 0.00 ... [0.00]* ... 20.00 V * Default setting depending on the size.	
0x2947:016	Inverter characteristic: Value y16 0.00 ... [0.00]* ... 20.00 V * Default setting depending on the size.	
0x2947:017	Inverter characteristic: Value y17 0.00 ... [0.00]* ... 20.00 V * Default setting depending on the size.	

Motor control

Optimisation of the control loops
Motor equivalent circuit diagram data



7.4.3 Motor equivalent circuit diagram data

The motor equivalent circuit diagram data are automatically set if one of the following optimisations is carried out:

- ▶ [Motor selection from motor catalogue](#) 169
- ▶ [Automatic motor identification \(energized\)](#) 171
- ▶ [Automatic motor calibration \(non-energized\)](#) 172

Parameter	Name / value range / [default setting]	Info
0x2C01:002	Motor parameters: Stator resistance 0.0000 ... [10.1565]* ... 125.0000 Ω * Default setting depending on the size.	General motor data. Carry out settings as specified by manufacturer data/motor data sheet.
0x2C01:003	Motor parameters: Stator leakage inductance 0.000 ... [23.566]* ... 500.000 mH * Default setting depending on the size.	
0x2C02:001 (P351.01)	Motor parameter (ASM): Rotor resistance (ASM motor par.: Rotor resistance) 0.0000 ... [8.8944]* ... 200.0000 Ω * Default setting depending on the size.	Equivalent circuit data of the motor required for the motor model.
0x2C02:002 (P351.02)	Motor parameter (ASM): Mutual inductance (ASM motor par.: Mutual induct.) 0.0 ... [381.9]* ... 50000.0 mH * Default setting depending on the size.	
0x2C02:003 (P351.03)	Motor parameter (ASM): Magnetising current (ASM motor par.: Magn. current) 0.00 ... [0.96]* ... 500.00 A * Default setting depending on the size.	



7.4.4 Motor controller settings

After the motor settings have been made, the different control loops must be set. For a quick commissioning, the calculations and settings are made automatically if one of the following optimisations is carried out:

- ▶ [Motor selection from motor catalogue](#) 169
- ▶ [Automatic motor identification \(energized\)](#) 171
- ▶ [Automatic motor calibration \(non-energized\)](#) 172

Details

The following controllers have an influence in the respective motor control type:

Controller	Motor control type				
	VFC open loop	VFC closed loop	SC-ASM	SL-PSM	SLVC
Current controller 175	●	●	●	●	●
Field controller 176			●		●
Field weakening controller 176			●		●
Imax controller 177	●	●			
Flying restart controller 178	●			●	●
SLVC controller 178					●
Slip controller 183		●			

VFC open loop = V/f characteristic control
 VFC closed loop = V/f characteristic control with speed feedback
 SC-ASM = servo control for asynchronous motor
 SL-PSM = sensorless control for synchronous motor
 SLVC = sensorless vector control

7.4.4.1 Current controller

For a quick commissioning, the calculations and settings are made automatically during the optimisation.



For typical applications, a manual adaptation of the parameters of the current controller is not recommended. A wrong setting may have a negative effect on the control. For special applications, contact the manufacturer before adapting the parameters.

Preconditions

The current controller parameters are calculated based on the stator resistance and leakage inductance. Thus, the following parameters must be set correctly, either via optimisation or manually (according to manufacturer-data/motor data sheet):

- [0x2C01:002](#): Stator resistance
- [0x2C01:003](#): Stator leakage inductance

▶ [Motor equivalent circuit diagram data](#) 174

Parameter	Name / value range / [default setting]	Info
0x2942:001 (P334.01)	Current controller parameters: Gain (Current contr.: Gain) 0.00 ... [42.55] * ... 750.00 V/A * Default setting depending on the size.	Gain factor V_p of the current controller.
0x2942:002 (P334.02)	Current controller parameters: Reset time (Current contr.: Reset time) 0.01 ... [4.50] * ... 2000.00 ms * Default setting depending on the size.	Reset time T_i of the current controller.

Motor control

Optimisation of the control loops
Motor controller settings



7.4.4.2 Field controller

For a quick commissioning, the calculations and settings are made automatically during the optimisation.

Preconditions

The field controller is only effective in the following motor control types:

- Servo control (SC ASM)
- Sensorless vector control (SLVC)

Parameter	Name / value range / [default setting]	Info
0x29C0:001	Gain 0.00 ... [59.68]* ... 50000.00 A/Vs * Default setting depending on the size.	Gain factor V_p of the field controller.
0x29C0:002	Reset time 1.0 ... [45.5]* ... 6000.0 ms * Default setting depending on the size.	Reset time T_n of the field controller.

7.4.4.3 Field weakening controller

For a quick commissioning, the calculations and settings are made automatically during the optimisation.

Preconditions

The field weakening controller is only effective in the following motor control types:

- Servo control (SC ASM)
- Sensorless vector control (SLVC)

Parameter	Name / value range / [default setting]	Info
0x29E0:001	Field weakening controller settings: Gain 0.000 ... [0.000]* ... 2000000.000 Vs/V * Default setting depending on the size.	Gain factor V_p of the field weakening controller.
0x29E0:002	Field weakening controller settings: Reset time 1.0 ... [1478.3]* ... 240000.0 ms * Default setting depending on the size.	Reset time T_n of the field weakening controller.
0x29E1	Field weakening controller Field limitation 5.00 ... [100.00] ... 100.00 % • From version 04.00	Field limitation of the field weakening controller.

7.4.4.4 Field weakening controller (advanced)

For a quick commissioning, the calculations and settings are made automatically during the optimisation.

Preconditions

The field weakening controller is only effective in the following motor control types:

- Servo control (SC ASM)
- Sensorless vector control (SLVC)

Parameter	Name / value range / [default setting]	Info
0x29E2	DC-bus filter time 1.0 ... [25.0] ... 1000.0 ms	Filter time for the current DC-bus voltage.
0x29E3	Motor voltage filter time 1.0 ... [25.0] ... 1000.0 ms	Filter time for the current motor voltage.
0x29E4 (P354.00)	Voltage reserve range (Voltage reserve) 1 ... [5] ... 20 %	Voltage reserve range at the transition point to the field weakening. • Only relevant if 0x2C00 (P300.00) is set = "Servo control (SC ASM) [2]".



7.4.4.5 I_{max} controller

For a quick commissioning, the calculations and settings are made automatically during the optimisation.



For typical applications, a manual adaptation of the parameters of the I_{max} controller is not recommended. A wrong setting may have a negative effect on the control. For special applications, contact the manufacturer before adapting the parameters.

Preconditions

The I_{max} controller is only effective in the following motor control types:

- V/f characteristic control (VFC open loop)
- V/f characteristic control (VFC closed loop)

Details

The I_{max} controller becomes active in the V/f operation if the actual motor current exceeds the maximum overload current "Max current". The I_{max} controller changes the output frequency to counteract the exceedance.

The maximum overload current "Max current" is defined in [0x6073 \(P324.00\)](#) in percent with regard to the rated motor current "Motor rated current" [0x6075 \(P323.00\)](#).

If the maximum overload current is exceeded:

- During operation in motor mode, the I_{max} controller reduces the output frequency.
- During operation in generator mode, the I_{max} controller increases the output frequency.

Setting notes

If oscillations occur at the current limit during operation:

- Reduce gain of the I_{max} controller in [0x2B08:001 \(P333.01\)](#).
- Increase reset time of the I_{max} controller in [0x2B08:002 \(P333.02\)](#).
- Carry out the changes in small steps only (by 2 ... 3 % of the set value) until the oscillations do not exist anymore.

If the I_{max} controller does not respond fast enough after the maximum current has been exceeded:

- Increase gain of the I_{max} controller in [0x2B08:001 \(P333.01\)](#).
- Reduce reset time of the I_{max} controller in [0x2B08:002 \(P333.02\)](#).
- Carry out the changes in small steps only (by 2 ... 3 % of the set value) until the response time is acceptable.

Parameter	Name / value range / [default setting]	Info
0x2822:019	Calculate I _{max} controller parameter 0 ... [0] ... 1	1 = start automatic calculation of the I _{max} controller parameters. • Gain 0x2B08:001 (P333.01) and reset time 0x2B08:002 (P333.02) of the I _{max} controller are recalculated and set.
0x2B08:001 (P333.01)	V/f I _{max} controller: Gain (V/f I _{max} contr.: Gain) 0.000 ... [0.284]* ... 1000.000 Hz/A * Default setting depending on the size.	Gain factor V _p of the I _{max} controller.
0x2B08:002 (P333.02)	V/f I _{max} controller: Reset time (V/f I _{max} contr.: Reset time) 1.0 ... [2.3]* ... 2000.0 ms * Default setting depending on the size.	Reset time T _i of the I _{max} controller.

Motor control

Optimisation of the control loops
Motor controller settings



7.4.4.6 Flying restart controller

For a quick commissioning, the calculations and settings are made automatically during the optimisation.

Preconditions

The flying restart controller is only effective in the following motor control types:

- V/f characteristic control (VFC open loop)
- Sensorless control (SL PSM)
- Sensorless vector control (SLVC)

Details

The following parameter is only relevant for the flying restart circuit if an asynchronous motor is controlled. In case of a sensorless control of a synchronous motor (SL-PSM) the parameter has no meaning.

Parameter	Name / value range / [default setting]	Info
0x2BA1:003 (P718.03)	Flying restart circuit: Restart time (Flying restart: Restart time) 1 ... [5911]* ... 60000 ms * Default setting depending on the size.	Integration time for controlling the flying restart circuit.

7.4.4.7 SLVC controller

For a quick commissioning, the calculations and settings are made automatically during the optimisation.

Preconditions

The SLVC controller is only effective in the motor control type "Sensorless vector control (SLVC)".

Parameter	Name / value range / [default setting]	Info
0x2B40:001	Gain 0.0000 ... [0.2686]* ... 1000.0000 Hz/A * Default setting depending on the size.	Gain of the SLVC-Q controller.
0x2B40:002	Reset time 1.0 ... [2.3]* ... 2000.0 ms * Default setting depending on the size.	Reset time of the SLVC-Q controller.



7.4.4.8 Torque control w/ freq. limit

In general, the inverter is operated in a mode that controls the motor frequency. Alternatively, the inverter can be configured in such a way that it controls a motor torque within a defined frequency range.

Typical applications for such a torque control with frequency limitation are winders and packaging machines.

Preconditions

A torque control is only possible in the motor control type [0x2C00 \(P300.00\)](#) = "Sensorless vector control (SLVC) [4]". Thus, first this motor control type must be configured. For details see chapter "[Sensorless vector control \(SLVC\)](#)". [145](#)

After configuring the sensorless vector control (SLVC), one of the following optimisations must be carried out for a torque control as precise as possible:

- ▶ [Automatic motor identification \(energized\)](#) [171](#)
- ▶ [Automatic motor calibration \(non-energized\)](#) [172](#)

Details

Setpoint selection:

- Instead of a frequency setpoint in [Hz], a torque setpoint has to be defined for the torque control. This can be either a value in percent with reference to the rated motor torque set in [0x6076 \(P325.00\)](#) or a value in [Nm] if defined via network.
- The standard setpoint source for the torque control can be selected in [0x2860:003 \(P201.03\)](#) (default setting: Analog input 1).
- Corresponding functions make it possible to change over to other setpoint sources during operation. ▶ [Setpoint change-over](#) [514](#)

Limitation of the torque range:

- The positive and negative torque limit can be set independently of each other.

Frequency limitation / speed limitation:

- The adjustable speed limits serve to protect against very high speeds. High speeds can occur if a pure torque is selected without a counter torque being available (load-free machine).
- The torque control controls the assigned torque setpoint within the set speed limits. The actual speed results from the load conditions of the application. If the actual speed reaches the set speed limits, it is kept on the respective limit value. This protective function is also called "speed limitation".
- The lower and upper speed limit for speed limitation can be set independently of each other. They can also be defined via analog inputs or network.

In the following, the steps required for configuring the torque control with frequency limitation are described.

Motor control

Optimisation of the control loops
Motor controller settings



Parameterisation required

1. Set the operating mode "MS: Torque mode [-1]" in [0x6060 \(P301.00\)](#).
2. Set the rated motor torque in [0x6076 \(P325.00\)](#).
3. Set the permissible maximum torque in [0x6072 \(P326.00\)](#).
 - The setting is made in percent with reference to the rated motor torque set in [0x6076 \(P325.00\)](#).
4. Select the source for the positive torque limit in [0x2949:001 \(P337.01\)](#).
 - Default setting: Maximum torque [0x6072 \(P326.00\)](#)
 - In case of selection "Analog Input 1 [2]": Set setting range in [0x2636:011 \(P430.11\)](#) and [0x2636:012 \(P430.12\)](#).
 - In case of selection "Analog Input 2 [3]": Set setting range in [0x2637:011 \(P431.11\)](#) and [0x2637:012 \(P431.12\)](#).
 - In case of selection "Positive torque limit [4]": Set the positive torque limit in [0x60E0](#).
5. Select the source for the negative torque limit in [0x2949:002 \(P337.02\)](#).
 - Default setting: (-) Maximum torque [0x6072 \(P326.00\)](#)
 - In case of selection "Analog Input 1 [2]": Set setting range in [0x2636:011 \(P430.11\)](#) and [0x2636:012 \(P430.12\)](#).
 - In case of selection "Analog Input 2 [3]": Set setting range in [0x2637:011 \(P431.11\)](#) and [0x2637:012 \(P431.12\)](#).
 - In case of selection "Negative torque limit [4]": Set the negative torque limit in [0x60E1](#).
6. Select the source for the upper speed limit in [0x2946:003 \(P340.03\)](#).
 - Default setting: Maximum frequency [0x2916 \(P211.00\)](#)
 - In case of selection "Analog input 1 [2]": Set setting range in [0x2636:002 \(P430.02\)](#) and [0x2636:003 \(P430.03\)](#).
 - In case of selection "Analog input 2 [3]": Set setting range in [0x2637:002 \(P431.02\)](#) and [0x2637:003 \(P431.03\)](#).
 - In case of selection "Upper speed limit [Hz] [4]": Set the upper speed limit in [Hz] in [0x2946:005 \(P340.05\)](#).
 - In case of selection "Upper speed limit [5]": Set the upper speed limit in [vel. unit in [0x2946:001 \(P340.01\)](#).
7. Select the source for the lower speed limit in [0x2946:004 \(P340.04\)](#).
 - Default setting: (-) Maximum frequency [0x2916 \(P211.00\)](#)
 - In case of selection "Analog input 1 [2]": Set setting range in [0x2636:002 \(P430.02\)](#) and [0x2636:003 \(P430.03\)](#).
 - In case of selection "Analog input 2 [3]": Set setting range in [0x2637:002 \(P431.02\)](#) and [0x2637:003 \(P431.03\)](#).
 - In case of selection "Lower frequency limit [4]": Set the lower speed limit in [Hz] in [0x2946:006 \(P340.06\)](#).
 - In case of selection "Lower speed limit [5]": Set the lower speed limit in [vel. unit in [0x2946:002 \(P340.02\)](#).
8. Select the standard setpoint source for the torque control in [0x2860:003 \(P201.03\)](#).
 - Default setting: Analog input 1. In case of this selection, set the setting range in [0x2636:011 \(P430.11\)](#) and [0x2636:012 \(P430.12\)](#).
 - In case of selection "Analog input 2 [3]": Set the setting range in [0x2637:011 \(P431.11\)](#) and [0x2637:012 \(P431.12\)](#).
 - Except for the network, the torque setpoint must be given in percent with regard to the [0x6076 \(P325.00\)](#) rated motor torque.
 - Via network the torque setpoint is selected via the mappable parameter [0x400B:008 \(P592.08\)](#) in [Nm / 2^{scaling factor}]. The scaling factor can be set in [0x400B:009 \(P592.09\)](#).
9. Optionally: For a "smooth" change-over between different setpoint sources, adapt the ramp time for the torque setpoint in [0x2948:002 \(P336.02\)](#).

The torque control with frequency limitation is now active and the inverter responds to the torque setpoint given by the selected setpoint source.



Diagnostic parameters:

- **0x2DD5**: Torque setpoint
- **0x2949:003 (P337.03)**: Actual positive torque limit
- **0x2949:004 (P337.04)**: Actual negative torque limit
- **0x2946:007 (P340.07)**: Speed limitation: Actual upper speed limit
- **0x2946:008 (P340.08)**: Speed limitation: Actual lower speed limit

Parameter	Name / value range / [default setting]	Info
0x2912:001 (P452.01)	Torque setpoint presets: Preset 1 (Torque presets: Torque preset 1) -400.0 ... [100.0] ... 400.0 %	Parameterisable torque setpoints (presets) for operating mode "MS: Torque mode". • 100 % ≡ Motor rated torque 0x6076 (P325.00)
0x2912:002 (P452.02)	Torque setpoint presets: Preset 2 (Torque presets: Torque preset 2) -400.0 ... [100.0] ... 400.0 %	
0x2912:003 (P452.03)	Torque setpoint presets: Preset 3 (Torque presets: Torque preset 3) -400.0 ... [100.0] ... 400.0 %	
0x2912:004 (P452.04)	Torque setpoint presets: Preset 4 (Torque presets: Torque preset 4) -400.0 ... [100.0] ... 400.0 %	
0x2912:005 (P452.05)	Torque setpoint presets: Preset 5 (Torque presets: Torque preset 5) -400.0 ... [100.0] ... 400.0 %	
0x2912:006 (P452.06)	Torque setpoint presets: Preset 6 (Torque presets: Torque preset 6) -400.0 ... [100.0] ... 400.0 %	
0x2912:007 (P452.07)	Torque setpoint presets: Preset 7 (Torque presets: Torque preset 7) -400.0 ... [100.0] ... 400.0 %	
0x2912:008 (P452.08)	Torque setpoint presets: Preset 8 (Torque presets: Torque preset 8) -400.0 ... [100.0] ... 400.0 %	
0x2946:001 (P340.01)	Speed limitation: Upper speed limit (Speed limitation: Upper limit) -480000 ... [0] ... 480000 vel. unit • From version 03.00	Upper limit for the speed limitation. • Setting is only effective with the selection "Upper speed limit [5]" in 0x2946:003 (P340.03) .
0x2946:002 (P340.02)	Speed limitation: Lower speed limit (Speed limitation: Lower limit) -480000 ... [0] ... 480000 vel. unit • From version 03.00	Lower limit for speed limitation. • Setting is only effective with the selection "Lower speed limit [5]" in 0x2946:004 (P340.04) .
0x2946:003 (P340.03)	Speed limitation: Upper speed limit source (Speed limitation: Uppspped lim src) • From version 03.00	Selection of the source for the upper speed limit.
	0 Maximum frequency	Upper speed limit = Maximum frequency 0x2916 (P211.00) .
	1 Fixed Limit 0.0 Hz	Upper speed limit = 0.0 Hz.
	2 Analog input 1	The upper speed limit is defined as analog signal via the analog input 1. ▶ Analog input 1 📄 568
	3 Analog input 2	The upper speed limit is defined as analog signal via the analog input 2. ▶ Analog input 2 📄 572
	4 Upper speed limit [Hz]	Upper speed limit = setting in 0x2946:005 (P340.05) in [Hz].
	5 Upper speed limit	Upper speed limit = setting in 0x2946:001 (P340.01) in [vel. unit].
6 Network target velocity	The upper speed limit is defined as process data object via network. ▶ Configuring the network 📄 199	

Motor control

Optimisation of the control loops
Motor controller settings



Parameter	Name / value range / [default setting]	Info
0x2946:004 (P340.04)	Speed limitation: Lower speed limit source (Speed limitation: Lowspeed lim src) • From version 03.00	Selection of the source for the lower speed limit.
	0 (-) Maximum frequency	Lower speed limit = (-) Maximum frequency 0x2916 (P211.00).
	1 Fixed Limit 0.0 Hz	Lower speed limit = 0.0 Hz.
	2 Analog input 1	The lower speed limit is defined as analog signal via the analog input 1. ▶ Analog input 1 □ 568
	3 Analog input 2	The lower speed limit is defined as analog signal via the analog input 2. ▶ Analog input 2 □ 572
	4 Lower frequency limit	Lower speed limit = setting in 0x2946:006 (P340.06) in [Hz].
	5 Lower speed limit	Lower speed limit = setting in 0x2946:002 (P340.02) in [vel. unit].
0x2946:005 (P340.05)	Speed limitation: Upper frequency limit (Speed limitation: Upper freq.limit) Device for 50-Hz mains: -1000.0 ... [50.0] ... 1000.0 Hz Device for 60-Hz mains: -1000.0 ... [60.0] ... 1000.0 Hz • From version 03.00	Upper limit for the speed limitation. • Setting is only effective with the selection "Lower frequency limit [4]" in 0x2946:004 (P340.04).
	Speed limitation: Lower frequency limit (Speed limitation: Lower freq.limit) Device for 50-Hz mains: -1000.0 ... [-50.0] ... 1000.0 Hz Device for 60-Hz mains: -1000.0 ... [-60.0] ... 1000.0 Hz • From version 03.00	Lower limit for speed limitation. • Setting is only effective with the selection "Lower frequency limit [4]" in 0x2946:004 (P340.04).
	Speed limitation: Actual upper speed limit (Speed limitation: Act uppspeed lim) • Read only: x.x Hz • From version 03.00	Display of the current upper limit for speed limitation.
	Speed limitation: Actual lower speed limit (Speed limitation: Act lowspeed lim) • Read only: x.x Hz • From version 03.00	Display of the current lower limit for speed limitation.
	ramp time (Ramp time) 0.0 ... [1.0] ... 60.0 s • From version 03.00	Ramp time for operating mode "MS: Torque mode". • The torque setpoint is led via a ramp generator. This provides for a "smooth" switch-over between different setpoint sources. • The set ramp time refers to the ramping up/down of 0 ... 100 % rated motor torque 0x6076 (P325.00). At a lower setpoint selection, the ramp time is reduced accordingly.
	Positive torque limit source (Pos. torqlim src) • From version 03.00	Selection of the source for the positive torque limit source.
	0 Max torque	Positive torque limit source = Max torque 0x6072 (P326.00).
1 Fixed Limit 0.0 %	Positive torque limit source = 0.0 %.	
2 Analog Input 1	The positive torque limit source is defined as analog signal via the analog input 1. ▶ Analog input 1 □ 568	
3 Analog Input 2	The positive torque limit source is defined as analog signal via the analog input 2. ▶ Analog input 2 □ 572	
4 Positive torque limit	Positive torque limit source = Positive torque limit 0x60E0.	
5 Network target torque	The positive torque limit source is defined as process data object via network. ▶ Configuring the network □ 199	



Parameter	Name / value range / [default setting]	Info
0x2949:002 (P337.02)	Negative torque limit source (Neg. torqlim src) • From version 03.00	Selection of the source for the negative torque limit source.
	0 (-) Max torque	Negative torque limit source = (-) Max torque 0x6072 (P326.00) .
	1 Fixed Limit 0.0 %	Negative torque limit source = 0.0 %.
	2 Analog Input 1	The negative torque limit source is defined as analog signal via the analog input 1. ▶ Analog input 1 1568
	3 Analog Input 2	The negative torque limit source is defined as analog signal via the analog input 2. ▶ Analog input 2 1572
	4 Negative torque limit	Negative torque limit source = Negative torque limit 0x60E1 .
0x2949:003 (P337.03)	Actual positive torque limit (Act postorqlim) • Read only: x.x % • From version 03.00	Display of the current positive torque limit. • 100 % ≙ Motor rated torque 0x6076 (P325.00)
	0x2949:004 (P337.04)	Actual negative torque limit (Act negtorqlim) • Read only: x.x % • From version 03.00
0x2DD5	Torque setpoint • Read only: x.xx Nm • From version 03.00	Display of the current torque setpoint.

7.4.4.9 Slip controller

In case of V/f characteristic control with feedback (VFC closed loop), the slip is calculated and injected by the slip controller. The default setting of the slip controller provides robustness and moderate dynamics.

Preconditions

In [0x2C00 \(P300.00\)](#), the motor control type "V/f characteristic control (VFC closed loop) [7]" is selected and configured. For details, see chapter "[V/f characteristic control \(VFC closed loop\)](#)". [144](#)

Details

- The slip controller is designed as PI controller.
- In order to improve the response to setpoint changes, the setpoint speed of setpoint frequency is added as feedforward control value to the output (correcting variable) of the slip controller.
- With the setting [0x2B14:003](#) = 0 Hz, the slip controller is deactivated.

Parameter	Name / value range / [default setting]	Info
0x2B14:001	Gain 0.000 ... [0.100] ... 65.535	Gain of the slip controller.
0x2B14:002	Reset time 0.0 ... [100.0] ... 6553.5 ms	Reset time of the slip controller.
0x2B14:003	Frequency limitation 0.00 ... [10.00] ... 100.00 Hz	Frequency limitation of the slip controller. • With the setting of 0 Hz, the slip controller is deactivated.

Motor control

Optimisation of the control loops
Speed controller



7.4.5 Speed controller

The speed controller is automatically set if one of the following optimisations is carried out:

- ▶ [Motor selection from motor catalogue](#) 169
- ▶ [Automatic motor identification \(energized\)](#) 171
- ▶ [Automatic motor calibration \(non-energized\)](#) 172



For typical applications, a manual adaptation of the parameters of the speed controller is not recommended. A wrong setting may have a negative effect on the control. For special applications, contact the manufacturer before adapting the parameters.

Details

The speed controller has an influence in the following motor control types:

- Servo control (SC ASM)
- Sensorless control (SL PSM)
- Sensorless vector control (SLVC)

The automatically calculated settings for the speed controller enable an optimal control behaviour for typical load requirements:

- Minimum speed loss ①
- Minimum settling time ②
- Minimum overshoot ③

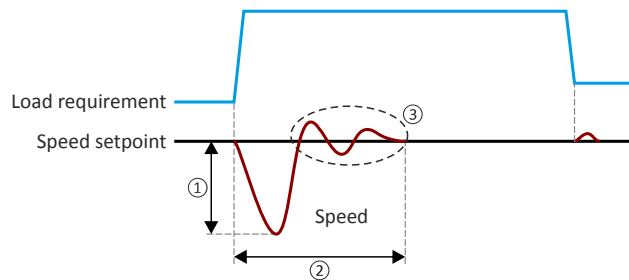

Setting notes

If oscillations occur during operation after high load requirements:

- Reduce gain of the speed controller in [0x2900:001 \(P332.01\)](#).
- Increase reset time of the speed controller in [0x2900:002 \(P332.02\)](#).

If the speed loss is too high or the settling time too long during operation with high load requirements:

- Increase gain of the speed controller in [0x2900:001 \(P332.01\)](#).



If the gain is set too high or the reset time too low, the speed control loop can become unstable!

Parameter	Name / value range / [default setting]	Info
0x2900:001 (P332.01)	Speed controller settings: Gain (Speed controller: Gain) 0.00000 ... [0.00193]* ... 20000.00000 Nm/rpm * Default setting depending on the size.	Gain factor V_p of the speed controller.
0x2900:002 (P332.02)	Speed controller settings: Reset time (Speed controller: Reset time) 1.0 ... [80.0]* ... 6000.0 ms * Default setting depending on the size.	Reset time T_i of the speed controller.
0x2904	Actual speed filter time 0.0 ... [2.0] ... 50.0 ms	Filter time for the actual speed value.



7.5 Motor rotating direction

In the default setting, both directions of motor rotation are enabled. Optionally, the direction of rotation can be restricted so that only a clockwise rotation (CW) of the motor is possible.

Preconditions

Wiring of the motor phases must be carried out correctly with regard to the direction of motor rotation.

In the documentation and the parameter selection texts, the following terms are used for the direction of rotation:

- Forward = clockwise direction of rotation (CW)
- Reverse = counter-clockwise direction of rotation (CCW)

Details

The direction of rotation of the motor can be controlled in various ways:

- Via the function "Invert rotation". Possible triggers to be selected for the function "Invert rotation" are available for example in [0x2631:013 \(P400.13\)](#) the digital inputs and internal status signals of the inverter.
- Via network. The definition of the direction of rotation is possible via the mappable Net-WordIN1 data word or one of the predefined process data words.
- By specifying a bipolar setpoint value via analog input. Either via bipolar input range (-10 ... +10 V) or configuration of a bipolar setting range.

If a reversal is not required, the direction of rotation can be restricted in [0x283A \(P304.00\)](#) to "Only clockwise (CW) [0]".

Parameter	Name / value range / [default setting]	Info
0x283A (P304.00)	Limitation of rotation (Limit. rotation)	Optional restriction of the rotating direction.
	0 Only clockwise (CW)	The motor can only be rotated clockwise (CW). The transfer of negative frequency and PID setpoints to the motor control is prevented. <ul style="list-style-type: none"> • This function takes effect after the "Invert rotation" function (0x2631:013 (P400.13)). • Since this function only prevents negative setpoints, counter-clockwise rotation (CCW) is possible if the motor has been wired for this rotating direction.
	1 Both rotation directions	Both directions of motor rotation are enabled.
0x2631:013 (P400.13)	Function list: Invert rotation (Function list: Invert rotation) <ul style="list-style-type: none"> • Setting can only be changed if the inverter is inhibited. • For further possible settings, see parameter 0x2631:001 (P400.01). 500 	Assignment of a trigger for the "Invert rotation" function. Trigger = TRUE: the setpoint specified is inverted (i. e. the sign is inverted). Trigger = FALSE: no action / deactivate function again.
	13 Digital input 3	State of X3/DI3, taking an inversion set in 0x2632:003 (P411.03) into consideration.

Motor control

Switching frequency changeover



7.6 Switching frequency changeover

The output voltage of the inverter is a DC voltage with sine-coded pulse width modulation (PWM). This corresponds by approximation to a AC voltage with variable frequency. The frequency of the PWM pulses is adjustable and is called "switching frequency".

Details

The switching frequency has an impact on the smooth running performance and the noise generation in the motor connected as well as on the power loss in the inverter. The lower the switching frequency, the better the concentricity factor, the smaller the power loss and the higher the noise generation.

Parameter	Name / value range / [default setting]	Info	
0x2939 (P305.00)	Switching frequency (Switching freq.) * Default setting depending on the size.	Selection of the inverter switching frequency. Abbreviations used: <ul style="list-style-type: none">• "Variable": adaptation of the switching frequency as a function of the current• "Drive-opt.": drive-optimised modulation ("sine/delta modulation")• "Fixed": fixed switching frequency• "Min. Pv": additional reduction of power loss	
	1		4 kHz variable / drive-optimised
	2		8 kHz variable / drive-optimised
	3		16 kHz variable / drive-optimised
	5		2 kHz fixed / drive-optimised
	6		4 kHz fixed / drive-optimised
	7		8 kHz fixed / drive-optimised
	8		16 kHz fixed / drive-optimised
	11		4 kHz variable / min. Pv
	12		8 kHz variable / min. Pv
	13		16 kHz variable / min. Pv
	15		2 kHz constant/min. Pv
	16		4 kHz constant/min. Pv
	17		8 kHz constant/min. Pv
	18		16 kHz constant/min. Pv
	21		8 kHz variable / drive-optimised / 4 kHz min.
22	16 kHz variable / drive-optimised / 4 kHz min.		
23	16 kHz variable / drive-optimised / 8 kHz min.		
31	8 kHz variable /min. Pv / 4 kHz min.		
32	16 kHz variable /min. Pv / 4 kHz min.		
33	16 kHz variable /min. Pv / 8 kHz min.		



7.7 Motor protection

Many monitoring functions integrated in the inverter can detect errors and thus protect the device or motor from being destroyed or overloaded.

- [Motor overload monitoring \(\$i^2 \cdot t\$ \)](#) 188
- [Motor temperature monitoring](#) 192
- [Current limits](#) 193
- [Overcurrent monitoring](#) 195
- [Motor phase failure detection](#) 196
- [Motor speed monitoring](#) 197
- [Motor torque monitoring](#) 197

Motor control

Motor protection

Motor overload monitoring ($i^2 \cdot t$)



7.7.1 Motor overload monitoring ($i^2 \cdot t$)

This function monitors the thermal utilisation of the motor, taking the motor currents recorded and a mathematical model as a basis.

DANGER!

Fire hazard by overheating of the motor.

Possible consequences: Death or severe injuries

- ▶ To achieve full motor protection, an additional temperature monitoring function with a separate evaluation must be installed.
- ▶ When actuating motors that are equipped with PTC thermistors or thermal contacts, always activate the PTC input.

Details

This function only serves to functionally protect the motor. It is not suitable for the safety-relevant protection against energy-induced hazards, since the implementation is not fail-safe.

- When the thermal motor utilisation calculated reaches the threshold set in [0x2D4B:001 \(P308.01\)](#), the response set in [0x2D4B:003 \(P308.03\)](#) is triggered.
- With the setting [0x2D4B:003 \(P308.03\)](#) = "No response [0]", the monitoring function is deactivated.



For a UL-compliant operation, leave [0x2D4B:002 \(P308.02\)](#) and [0x2D4B:003 \(P308.03\)](#) to the default setting!

(speed compensation = "on [0]" and error response = "Fault [3]")

In order to meet the UL requirements, the calculated motor load is internally saved when the inverter is switched off and loaded again when the inverter is switched on.



If a suitable motor temperature sensor is connected to the terminals X109/T1 and X109/T2 and the response to the triggering of the motor temperature monitoring in [0x2D49:002 \(P309.02\)](#) is set to "Fault [3]", the response of the motor overload monitoring may be set other than "Fault [3]" in [0x2D4B:003 \(P308.03\)](#).

▶ [Motor temperature monitoring](#)  192



The following two diagrams show the relation between the motor load and release time of the monitoring under the following conditions:

- Maximum utilisation **0x2D4B:001 (P308.01)** = 150 %
- Speed compensation **0x2D4B:002 (P308.02)** = "Off [1]" or output frequency ≥ 40 Hz

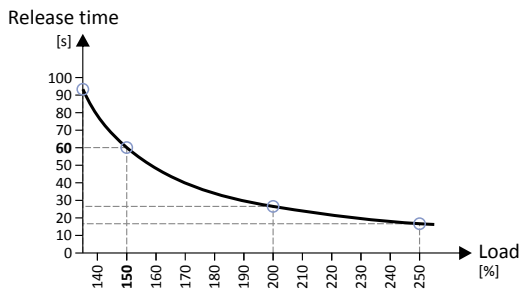
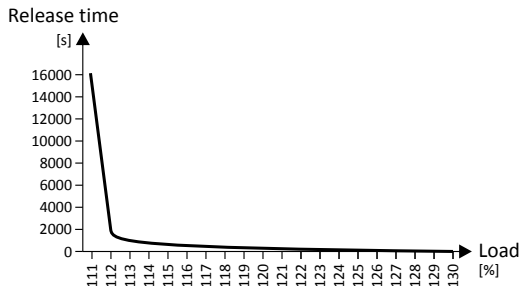

Load * Load ratio	Release time
110 %	Indefinite
135 %	93 s
150 %	60 s
200 %	26 s
250 %	17 s

Depending on the setting in **0x2D4B:001 (P308.01)**, the release time from the diagrams can be derived as follows:

- Calculation of the load ratio:
 $\text{Load ratio} = 150 \% / \text{maximum utilisation } \mathbf{0x2D4B:001 (P308.01)}$
 (example: **0x2D4B:001 (P308.01)** = 75 % \rightarrow load ratio = 150 % / 75 % = 2)
- Calculation of the release time of the monitoring:
 $\text{Release time} = \text{actual load} * \text{load ratio}$
 (example: actual load = 75 % \rightarrow release time = 75 % * 2 = 150 %)
- Looking up the release time from the above table based on load * load ratio.
 (example: Load * load ratio = 150 % \rightarrow release time = 60 s)

Motor control

Motor protection
Motor overload monitoring ($i^2 \cdot t$)



Speed compensation for protecting motors at low speed

The inverter comes with an implemented compensation for low speed. If the motor is driven with frequencies lower than 40 Hz, the speed compensation in [0x2D4B:002 \(P308.02\)](#) should be set to "On [0]" (default setting). This setting serves to reduce the release time of the monitoring at low speed to consider the reduced natural ventilation at AC motors. The speed compensation for UL-compliant operation in [0x2D4B:002 \(P308.02\)](#) must be set to "On [0]" as well.

If the speed compensation is activated, the release time is reduced as follows:

- With an output frequency < 40 Hz: Reduced release time to $62.5\% + 37.5\% \cdot \text{output frequency [Hz]} / 40 \text{ [Hz]}$
- With an output frequency ≥ 40 Hz: No reduced release time

The following diagram shows the reduced release time with activated speed compensation.

- Maximum utilisation [0x2D4B:001 \(P308.01\)](#) = 150 %
- Speed compensation [0x2D4B:002 \(P308.02\)](#) = "On [0]"

Release time

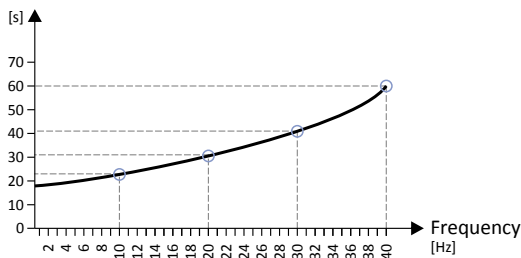

Output frequency	Release time
40 Hz	60 s
30 Hz	≈ 41 s
20 Hz	≈ 31 s
10 Hz	≈ 23 s

The following diagram shows the possible permanent load with activated speed compensation without the monitoring being triggered.

- Maximum utilisation [0x2D4B:001 \(P308.01\)](#) = 150 %
- Speed compensation [0x2D4B:002 \(P308.02\)](#) = "On [0]"

Load

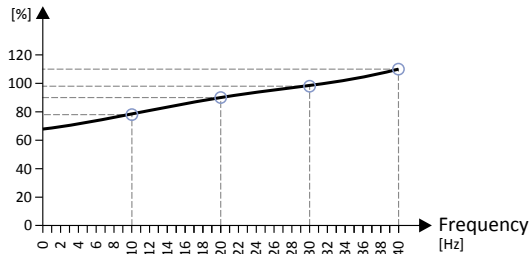

Output frequency	Possible permanent load
40 Hz	110 %
30 Hz	99 %
20 Hz	90 %
10 Hz	79 %

In case of 0 Hz, only a load of 62.7 % ($\approx 62.5\%$) with regard to the load at 40 Hz or above is possible ($69 / 110 \cdot 100\% = 62.7\%$). In case of a deviating setting in [0x2D4B:001 \(P308.01\)](#), the maximum possible motor load changes proportionately.

Parameter	Name / value range / [default setting]	Info
0x2D4B:001 (P308.01)	Motor overload monitoring ($i^2 \cdot t$): Maximum utilisation [60 s] (Motor overload: Max.load.for 60s) 30 ... [150] ... 200 %	<p>Maximum permissible thermal motor utilisation (max. permissible motor current for 60 seconds).</p> <ul style="list-style-type: none"> • 100 % \equiv rated motor current 0x6075 (P323.00) • If the motor is actuated with the current set here for 60 seconds, the maximum permissible thermal motor utilisation is reached and the response set in 0x2D4B:003 (P308.03) is executed. • If the motor is actuated with a different current, the time period until the motor overload monitoring function is activated is different. Generally the following applies: the lower the current, the lower the thermal utilisation and the later the monitoring function is triggered.



Motor control

Motor protection

Motor overload monitoring (i^2*t)

Parameter	Name / value range / [default setting]	Info
0x2D4B:002 (P308.02)	Motor overload monitoring (i^2*t): Speed compensation (Motor overload: Speed comp.)	Use this function to protect motors that are actuated at a speed below 40 Hz. <ul style="list-style-type: none"> UL-compliant operation requires the setting "On [0]"!
	0 On	Release time for motor overload monitoring is reduced in order to compensate for the reduced cooling of naturally ventilated AC induction motors during operation at low speed.
	1 Off	Function deactivated, no reduction of the motor overload monitoring release time.
0x2D4B:003 (P308.03)	Motor overload monitoring (i^2*t): Response (Motor overload: Response) <ul style="list-style-type: none"> For further possible settings, see parameter 0x2D45:001 (P310.01). □ 196 	Selection of the response to the triggering of motor overload monitoring. <ul style="list-style-type: none"> UL-compliant operation requires the setting "Error [3]"! Associated error code: <ul style="list-style-type: none"> 9040 0x2350 - CiA: i^2*t overload (thermal state)
	3 Fault	▶ Error types □ 113
0x2D4B:005	Motor overload monitoring (i^2*t): Thermal load <ul style="list-style-type: none"> Read only 	Display of the value of the internal i^2*t integrator. <ul style="list-style-type: none"> 37500 \equiv 100 % thermal load When power is switched off, this value is saved in the internal EEPROM. When power is switched on, the saved value is reloaded into the i^2*t integrator.

Motor control

Motor protection
Motor temperature monitoring



7.7.2 Motor temperature monitoring

In order to record and monitor the motor temperature, a PTC thermistor (single sensor according to DIN 44081 or triple sensor according to DIN 44082) or thermal contact (normally-closed contact) can be connected to the terminals T1 and T2. This measure helps to prevent the motor from being destroyed by overheating.

Preconditions

- The inverter can only evaluate one PTC thermistor! Do not connect several PTC thermistors in series or parallel.
- If several motors are actuated on one inverter, thermal contacts (NC contacts) connected in series are to be used.
- To achieve full motor protection, an additional temperature monitoring function with a separate evaluation must be installed.
- By default, a wire jumper is installed between terminals X109/T1 and X109/T2, which must be removed when the PTC thermistor or thermal contact is connected.

Details

If $1.6 \text{ k}\Omega < R < 4 \text{ k}\Omega$ at terminals X109/T1 and X109/T2, the monitoring function will be activated; see functional test below.

- If the monitoring function is activated, the response set in [0x2D49:002 \(P309.02\)](#) will be effected.
- The setting [0x2D49:002 \(P309.02\)](#) = 0 deactivates the monitoring function.



If a suitable motor temperature sensor is connected to the terminals X109/T1 and X109/T2 and the response in [0x2D49:002 \(P309.02\)](#) is set to "Fault [3]", the response of the motor overload monitoring may be set other than "Fault [3]" in [0x2D4B:003 \(P308.03\)](#).

▶ [Motor overload monitoring \(i²*t\)](#) 188

Functional test

Connect a fixed resistor to the PTC input:

- $R > 4 \text{ k}\Omega$: the monitoring function must be activated.
- $R < 1 \text{ k}\Omega$: the monitoring function must not be activated.

Parameter	Name / value range / [default setting]	Info
0x2D49:002 (P309.02)	Motor temperature monitoring: Response (Mot.temp.monit.: Response) <ul style="list-style-type: none">• For further possible settings, see parameter 0x2D45:001 (P310.01). 196	Selection of the response to the triggering of the motor temperature monitoring. Associated error code: <ul style="list-style-type: none">• 17168 0x4310 - Motor temperature error
	3 Fault	▶ Error types 113



7.7.3 Current limits

For the purpose of current limitation, a maximum overload current can be set for the inverter. If the current consumption of the motor exceeds this current limit, the inverter changes its dynamic behaviour, in order to counteract this exceedance.

Details

- The maximum overload current of the inverter can be set in [0x6073 \(P324.00\)](#).
- Reference for the percentage setting of the maximum overload current is the rated motor current set in [0x6075 \(P323.00\)](#).
- The actual motor current is displayed in [0x2D88 \(P104.00\)](#).



If the change in the dynamic behaviour carried out by the inverter does not result in exiting the overcurrent state, the inverter outputs an error.

Load behaviour	Impact
Overload during acceleration in motor mode	A longer time than is required for reaching the frequency setpoint is set.
Overload during deceleration in generator mode	A longer time than is required for reaching standstill is set.
Increasing load at constant frequency	If the motor current limit value is reached: <ul style="list-style-type: none"> • The inverter reduces the effective speed setpoint until a stable working is set or an effective speed setpoint of 0 rpm is reached. • If the load is reduced, the inverter increases the effective speed setpoint until the setpoint speed is reached or the load reaches the current limit value again.
	When the generator current limit value is reached: <ul style="list-style-type: none"> • The inverter increases the effective speed setpoint until a stable working point is reached or up to the maximum permissible output frequency 0x2916 (P211.00). • If the load is reduced, the inverter reduces the effective speed setpoint until the setpoint speed is reached or the load reaches the current limit value again.
	If an abrupt load is building at the motor shaft (e.g. drive is blocked), the overcurrent switch-off function may respond.

Example: Overcurrent switch-off in case of a sudden load at the motor shaft

Frequency setpoint selection

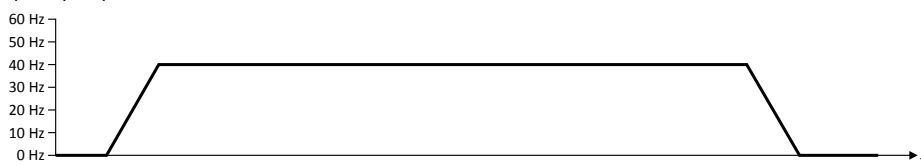

Output frequency

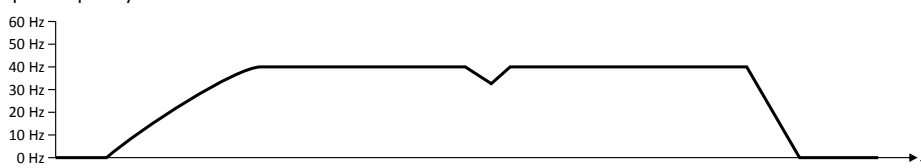

Motor load

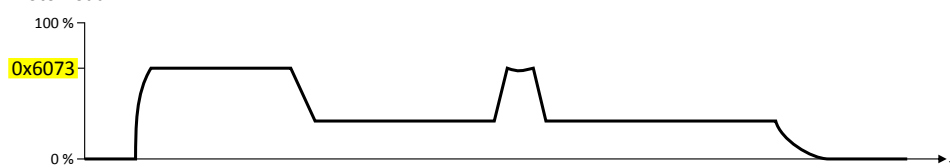

Motor control

Motor protection
Current limits



Parameter	Name / value range / [default setting]	Info
0x6073 (P324.00)	Max current (Max current) 0.0 ... [200.0] ... 3000.0 %	Maximum overload current of the inverter. <ul style="list-style-type: none">• 100 % \equiv Motor rated current 0x6075 (P323.00)• If the current consumption of the motor exceeds this current limit, the inverter changes its dynamic behaviour, in order to counteract this exceedance.• If the change in the dynamic behaviour carried out by the inverter does not result in exiting the overcurrent state, the inverter outputs an error. Note! This parameter is not identical to the so-called ultimate motor current I_{ULT} ! <ul style="list-style-type: none">• The ultimate motor current set in 0x2D46:001 (P353.01) is a limit value for synchronous motors that serves to protect their magnets.• The value to be set here should always be considerably below the ultimate motor current!
0x2D88 (P104.00)	Motor current (Motor current) <ul style="list-style-type: none">• Read only: x.x A	Display des present current-r.m.s. value.
0x6078 (P103.00)	Current actual value (Current actual) <ul style="list-style-type: none">• Read only: x.x %	Display of the present motor current. <ul style="list-style-type: none">• 100 % \equiv Motor rated current 0x6075 (P323.00)



7.7.4 Overcurrent monitoring

This function monitors the instantaneous value of the motor current and serves as motor protection.

i NOTICE

With an incorrect parameterisation, the maximum permissible motor current may be exceeded in the process.

Possible consequence: irreversible damage of the motor.

- ▶ The setting of the threshold for the overcurrent monitoring in [0x2D46:001 \(P353.01\)](#) must be adapted to the connected motor.
- ▶ Set the maximum output current of the inverter in [0x6073 \(P324.00\)](#) much lower than the threshold for overcurrent monitoring.

Details

The inverter monitors its output current. This monitoring takes place irrespective of the settings for the current limiting function. ▶ [Current limits](#) [193](#)

- If the instantaneous value of the motor current exceeds the threshold set in [0x2D46:001 \(P353.01\)](#), the response set in [0x2D46:002 \(P353.02\)](#) takes place.
- With the setting [0x2D46:002 \(P353.02\)](#) = "No response [0]", the monitoring function is deactivated.

The threshold for the overcurrent monitoring is preset to four times the rated motor current. This presetting is overwritten in case a motor in the engineering tool is selected from the "motor catalog" or the automatic identification or calibration of the motor data is carried out. For a suitable protection, the automatically adapted setting should be used. If disturbances occur during operation, the value can be increased.

Parameter	Name / value range / [default setting]	Info
0x2D46:001 (P353.01)	Overcurrent monitoring: Threshold (Overcurr. monit.: Threshold) 0.0 ... [6.8]* ... 1000.0 A * Default setting depending on the size. • From version 02.00	Warning/error threshold for motor current monitoring. • If the instantaneous value of the motor current exceeds the threshold set, the response set in 0x2D46:002 (P353.02) is effected for the purpose of motor protection. • The parameter is calculated and set in the course of the automatic identification of the motor. • The parameter can also be set and thus overwritten by selecting a motor in the engineering tool from the "motor catalog" or calibrating the motor. ▶ Optimisation of the control loops 165
0x2D46:002 (P353.02)	Overcurrent monitoring: Response (Overcurr. monit.: Response) • For further possible settings, see parameter 0x2D45:001 (P310.01) . 196	Selection of the response to the triggering of motor current monitoring. Associated error code: • 29056 0x7180 - Motor overcurrent
	3 Fault	▶ Error types 113

Motor control

Motor protection
Motor phase failure detection



7.7.5 Motor phase failure detection

The motor phase failure detection function can be activated for both synchronous and asynchronous motors.

Preconditions

Phase failure detection during operation is basically only suitable for applications which are operated with a constant load and speed. In all other cases, transient processes or unfavourable operating points can cause maloperation.

Details

If a current-carrying motor phase (U, V, W) fails during operation, the response selected in [0x2D45:001 \(P310.01\)](#) is tripped if the following two conditions are met:

- Condition 1: detection is activated. See [0x2D45:002 \(P310.02\)](#)
- Condition 2: a specific commutation angle (approx. 150° electrically) has been covered without the detection of a current flow.

Parameter	Name / value range / [default setting]	Info
0x2D45:001 (P310.01)	Motor phase failure detection: Response (Mot.phase.fail.: Response)	Selection of the response following the detection of a motor phase failure. Associated error codes: <ul style="list-style-type: none">• 65289 0xFF09 - Motor phase missing• 65290 0xFF0A - Motor phase failure phase U• 65291 0xFF0B - Motor phase failure phase V• 65292 0xFF0C - Motor phase failure phase W
	0 No response	▶ Error types 113
	1 Warning	
	2 Trouble	
	3 Fault	
0x2D45:002 (P310.02)	Motor phase failure detection: Current threshold (Mot.phase.fail.: Current thresh.) 1.0 ... [5.0] ... 25.0 %	Current threshold for the activation of the motor phase failure detection function. <ul style="list-style-type: none">• 100 % ≡ Maximum current 0x2DDF:002• Background: in order to be able to reliably detect the failure of a motor phase, first a certain must flow for the current sensor system. The detection function is therefore only activated if the actual value of the motor current has exceeded the current threshold set here.• Display of the present motor current in 0x2D88 (P104.00).
0x2D45:003 (P310.03)	Motor phase failure detection: Voltage threshold (Mot.phase.fail.: Voltage thresh.) 0.0 ... [10.0] ... 100.0 V	Voltage threshold for the monitoring of several motor phases. <ul style="list-style-type: none">• The V/f characteristic control enables the detection of several failed motor phases during operation.• Monitoring with regard to the failure of several motor phases is active if a response that is not "0: No response" is set in 0x2D45:001 (P310.01) and if the motor voltage exceeds the voltage threshold set here.• The monitoring function is triggered if the level of the motor current is lower than the device-dependent threshold for longer than 20 ms.• The monitoring function for the failure of several motor phases can be deactivated if the value "100.0 V" is set here.



7.7.6 Motor speed monitoring

This function monitors the motor speed during operation.

Preconditions

- In order to detect the current motor speed, the inverter must be enabled and the motor must rotate.
- For an exact monitoring, rated motor speed [0x2C01:004 \(P320.04\)](#) and rated motor frequency [0x2C01:005 \(P320.05\)](#) must be set correctly.

Details

- If the motor speed reaches the threshold set in [0x2D44:001 \(P350.01\)](#), the response set in [0x2D44:002 \(P350.02\)](#) takes place.
- With the setting [0x2D44:002 \(P350.02\)](#) = "No response [0]", the monitoring function is deactivated.

Parameter	Name / value range / [default setting]	Info
0x2D44:001 (P350.01)	Overspeed monitoring: Threshold (Overspeed monit.: Threshold) 50 ... [8000] ... 50000 rpm	Warning/error threshold for motor speed monitoring. <ul style="list-style-type: none"> • If the motor speed reaches the threshold set, the response selected in 0x2D44:002 (P350.02) is effected. • The parameter is calculated and set in the course of the automatic identification of the motor. • The parameter can also be set and thus overwritten by selecting a motor in the engineering tool from the "motor catalog" or calibrating the motor. ▶ Optimisation of the control loops 165
0x2D44:002 (P350.02)	Overspeed monitoring: Response (Overspeed monit.: Response) <ul style="list-style-type: none"> • For further possible settings, see parameter 0x2D45:001 (P310.01). 196 <div style="text-align: center;">3 Fault</div>	Selection of the response to the triggering of motor speed monitoring. Associated error code: <ul style="list-style-type: none"> • 65286 0xFF06 - Motor overspeed ▶ Error types 113

7.7.7 Motor torque monitoring

This function monitors the motor torque during operation.

Preconditions

The motor torque monitoring can only be used for the following motor control types with speed controller:

- Servo control (SC ASM)
- Sensorless control (SL PSM)
- Sensorless vector control (SLVC)

Details

This function sets the internal status signal "Torque limit reached [79]" = TRUE if the maximum possible torque has been reached.

- The status signal is set irrespective of the response [0x2D67:001 \(P329.01\)](#) and delay time [0x2D67:002 \(P329.02\)](#) set for this monitoring.
- The user can use the status signal to activate certain functions. [▶ Flexible I/O configuration](#) [493](#)
- The status signal also serves to set a digital output or a bit of the NetWordOUT1 status word. [▶ Configuration of digital outputs](#) [574](#)

Parameter	Name / value range / [default setting]	Info
0x2D67:001 (P329.01)	Maximum torque monitoring: Response (MaxTrq.Monitor: Response) <ul style="list-style-type: none"> • From version 02.00 • For further possible settings, see parameter 0x2D45:001 (P310.01). 196 <div style="text-align: center;">0 No response</div>	Selection of response to reaching the maximum possible torque. <ul style="list-style-type: none"> • The selected response takes place if the status signal "Torque limit reached [79]" = TRUE and the deceleration time set in 0x2D67:002 (P329.02) has elapsed. Associated error code: <ul style="list-style-type: none"> • 33553 0x8311 - Torque limit reached ▶ Error types 113

Motor control

Motor protection

Motor torque monitoring



Parameter	Name / value range / [default setting]	Info
0x2D67:002 (P329.02)	Maximum torque monitoring: Triggering delay (MaxTrq.Monitor: Triggering delay) 0.000 ... [0.000] ... 10.000 s <ul style="list-style-type: none"> From version 02.00 	Optional setting of a deceleration for triggering the response selected in 0x2D67:001 (P329.01) . Typical application: <ul style="list-style-type: none"> The motor should be driven at the torque limit for a short time without triggering the selected response. Only after a longer operation (> set deceleration) at the torque limit, the selected response is to take place.
0x6072 (P326.00)	Max torque (Max torque) 0.0 ... [250.0] ... 3000.0 % <ul style="list-style-type: none"> From version 02.00 	Symmetrical selection of the maximum permissible torque. <ul style="list-style-type: none"> 100 % ≡ Motor rated torque 0x6076 (P325.00) This parameter serves to implement a statically and bipolarly acting torque limitation. This can be used, for instance, as overload protection of the mechanical transmission path/elements starting at the motor shaft. This limitation acts irrespective of the torque limitations acting in unipolar mode that are set in 0x60E0 and 0x60E1.
0x60E0	Positive torque limit 0.0 ... [250.0] ... 3276.7 % <ul style="list-style-type: none"> From version 02.00 	Positive torque limit source for speed control with torque limitation. <ul style="list-style-type: none"> 100 % ≡ Motor rated torque 0x6076 (P325.00)
0x60E1	Negative torque limit 0.0 ... [250.0] ... 3276.7 % <ul style="list-style-type: none"> From version 02.00 	Negative torque limit source for speed control with torque limitation. <ul style="list-style-type: none"> 100 % ≡ Motor rated torque 0x6076 (P325.00)

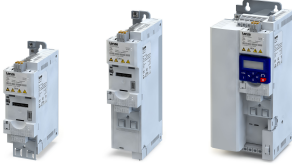

8 Configuring the network

The inverter is available as variants with different network options.

- [General network settings](#) 200
- [Predefined process data words](#) 219
- [Parameter access monitoring \(PAM\)](#) 231
- [Acyclic data exchange](#) 232
- [CANopen](#) 233
- [Modbus RTU](#) 255
- [PROFIBUS](#) 267
- [EtherNet/IP](#) 288
- [Modbus TCP/IP](#) 309
- [PROFINET](#) 329
- [EtherCAT](#) 343

Configuring the network

General network settings



8.1 General network settings

Activate network control

In order to be able to control the inverter via network, a trigger must be first assigned in [0x2631:037 \(P400.37\)](#) to the "Activate network control" function.

- This trigger can for instance be the constant value "TRUE" or a digital input.
- If the assigned trigger is = TRUE, the motor can only be started via the network control word (exception: Jog operation; see chapter "[Start / stop motor](#)" [499](#)).

In case of an activated network control, the following functions are still active:

- [0x2631:001 \(P400.01\)](#): Enable inverter
- [0x2631:002 \(P400.02\)](#): Run
- [0x2631:003 \(P400.03\)](#): Activate quick stop
- [0x2631:004 \(P400.04\)](#): Reset fault
- [0x2631:005 \(P400.05\)](#): Activate DC braking
- [0x2631:010 \(P400.10\)](#): Jog forward (CW)
- [0x2631:011 \(P400.11\)](#): Jog reverse (CCW)
- [0x2631:012 \(P400.12\)](#): Activate keypad control
- [0x2631:037 \(P400.37\)](#): Activate network control
- [0x2631:054 \(P400.54\)](#): Position counter reset

All other functions configurable via [0x2631:xx \(P400.xx\)](#) are deactivated in case of network control. ▶ [Flexible I/O configuration](#) [493](#)

Network control word and status word

For establishing a simple network connection, the inverter provides predefined control and status words for device profile CiA 402, AC drive profile as well as in LECOM format. For implementing your own formats, the data words NetWordIN1 and NetWordOUT1 are available. By means of data mapping to a network register, each of these words can be transferred as process data via network.

Name	Parameter	Associated mapping entry *	Further information
CiA: Controlword	0x6040	0x60400010	▶ Device profile CiA 402 220
CiA: Statusword	0x6041 (P780.00)	0x60410010	
AC Drive control word	0x400B:001 (P592.01)	0x400B0110	▶ AC Drive Profile 221
AC Drive status word	0x400C:001 (P593.01)	0x400C0110	
LECOM control word	0x400B:002 (P592.02)	0x400B0210	▶ Lenze LECOM profile 225
LECOM status word	0x400C:002 (P593.02)	0x400C0210	
NetWordIN1	0x4008:001 (P590.01)	0x40080110	For implementing an individual control word format. The functions that are to be triggered via bits 0 ... 15 of the NetWordIN1 data word are defined in 0x400E:001 (P505.01) ... 0x400E:016 (P505.16) .
NetWordOUT1	0x400A:001 (P591.01)	0x400A0110	For implementing an individual status word format. The triggers for bits 0 ... 15 of the NetWordOUT1 data word are defined in 0x2634:010 (P420.10) ... 0x2634:025 (P420.25) .

* A mapping entry consists of index, subindex and data length in bits of the parameter to be mapped.

General information about the process of data mapping can be found in the chapter of the same name for the corresponding network.



Network setpoint

In order to set the network generally as a standard setpoint source, select "Network [5]" in [0x2860:001 \(P201.01\)](#). If another standard setpoint source is set, a change-over to the network setpoint via the used network control is possible in case the network control is activated:

Network control word	Change-over to network setpoint		
NetWordIN1 data word 0x4008:001 (P590.01)	Assign the function "Activate network setpoint [17]" to the bit that is to be used for activating the network setpoint. <ul style="list-style-type: none"> The functions that are to be triggered via bits 0 ... 15 of the NetWordIN1 data word are defined in 0x400E:001 (P505.01) ... 0x400E:016 (P505.16). 		
	Bit x	Selection:	
	0	Standard setpoint source selected in 0x2860:001 (P201.01) .	
	1	Network setpoint	
AC drive control word 0x400B:001 (P592.01)	The network setpoint is activated via bit 6 of the AC Drive control word:		
	Bit 6	Selection:	
	0	Standard setpoint source selected in 0x2860:001 (P201.01) .	
	1	Network setpoint	
LECOM control word 0x400B:002 (P592.02)	The setpoint is selected via bit 0 and bit 1 of the LECOM control word:		
	Bit 1	Bit 0	Selection:
	0	0	Standard setpoint source selected in 0x2860:001 (P201.01) .
	0	1	Frequency setpoint preset 1 0x2911:001 (P450.01)
	1	0	Frequency setpoint preset 2 0x2911:002 (P450.02)
	1	1	Frequency setpoint preset 3 0x2911:003 (P450.03)
CiA 402 Controlword 0x6040	In case of control via device profile CiA 402: <ul style="list-style-type: none"> In the operating mode "CiA: Velocity mode [2]", the setpoint speed defined via the "Target velocity" 0x6042 (P781.00) parameter is used. ▶ Device profile CiA 402 426 A change-over to an alternative setpoint source via the CiA 402 Controlword is not possible. 		



If a bipolar network setpoint is specified for the operating mode "MS: Velocity mode" (e.g. via the mappable parameter [0x400B:006 \(P592.06\)](#)), the direction of rotation cannot be controlled via the network control word. The direction of rotation is determined by the sign of the setpoint.

Parameter	Name / value range / [default setting]	Info
0x231F:001 (P500.01)	Module ID: Active module ID (Module ID: Active module ID)	Display of the network options currently configured in the inverter. <ul style="list-style-type: none"> With the help of this module ID, the keypad only shows the communication parameters relevant to the respective network. Note! When switched on, the inverter checks whether the parameter settings saved in the memory module match the inverter hardware and firmware. In case of an incompatibility, a corresponding error message is output. For details see chapter " Data handling " (section "Hardware and firmware updates/downgrades"). 115
	• Read only	
	48 No network	
	67 CANopen	
	71 EtherNet/IP (from version 02.00)	
	80 PROFIBUS	
	82 ProfiNet (from version 02.00)	
	84 EtherCAT (from version 02.00)	
86 Modbus TCP/IP		
87 Modbus		
0x231F:002 (P500.02)	Module ID: Module ID connected (Module ID: Module ID conn.)	Display of the network option currently available in the inverter. Note! When switched on, the inverter checks whether the parameter settings saved in the memory module match the inverter hardware and firmware. In case of an incompatibility, a corresponding error message is output. For details see chapter " Data handling " (section "Hardware and firmware updates/downgrades"). 115
	• Read only • For the meaning of the display see parameter 0x231F:001 (P500.01) . 201	
0x400E:001 (P505.01)	NetWordIN1 function: Bit 0 (NetWordIN1 fct.: NetWordIN1.00)	Definition of the function that is to be triggered via bit 0 of the mappable NetWordIN1 data word.
	• Setting can only be changed if the inverter is inhibited.	
	0 Not active	Trigger bit without any function.

Configuring the network

General network settings



Parameter	Name / value range / [default setting]	Info
	1 Disable inverter	<p>Trigger bit = 0-1 edge: The inverter is disabled. Trigger bit = 0: The inverter is enabled (unless there is another cause for inverter disable).</p> <p>Notes:</p> <ul style="list-style-type: none"> In all device states, a 0-1 edge causes an immediate change to the inhibited state with one exception: If the inverter is in the error status and the error condition still exists, the inverter remains in the error status. Changing to the disabled state causes an immediate stop of the motor, regardless of the stop method set in 0x2838:003 (P203.03). The motor coasts down as a function of the mass inertia of the machine. In the disabled state, the motor cannot be started. After the inverter disable is deactivated, a renewed start command is required to restart the motor. The cause(s) that are active for the disabled state are shown in 0x282A:001 (P126.01).
	2 Stopping	<p>Trigger bit = 1: Motor is stopped. Trigger bit = 0: No action / Deactivate stop again.</p> <p>Notes:</p> <ul style="list-style-type: none"> The stop method can be selected in 0x2838:003 (P203.03).
	3 Activate quick stop	<p>Trigger bit = 1: "Quick stop" function activated. Trigger bit = 0: no action / deactivate function again.</p> <p>Notes:</p> <ul style="list-style-type: none"> The "Quick stop" function brings the motor to a standstill within the deceleration time set in 0x291C (P225.00). The "Quick stop" function has a higher priority than the "Run" function.
	4 Reset error	<p>Trigger bit = 0-1 edge: Active error is reset (acknowledged) if the error condition is not active anymore and the error is resettable. Trigger bit = 0: No action.</p> <p>Notes:</p> <ul style="list-style-type: none"> After resetting the error, a new enable/start command is required to restart the motor. <p>▶ Error handling 113</p>
	5 Activate DC braking	<p>Trigger bit = 1: "DC braking" function activated. Trigger bit = 0: no action / deactivate function again.</p> <p>▶ DC braking 386</p>
	8 Run forward (CW)	<p>Trigger bit = 0-1 edge: Motor is started in forward rotating direction (CW). Trigger bit = 1-0 edge: Motor is stopped again.</p> <p>Notes:</p> <ul style="list-style-type: none"> The stop method can be selected in 0x2838:003 (P203.03). In the case of a bipolar setpoint selection (e.g. ± 10 V), the function is executed irrespective of the rotating direction. The rotating direction is determined by the sign of the setpoint. The function also serves to realise an automatic start after switch-on. ▶ Starting performance 126 The "Invert rotation [13]" function can be used in connection with this function.
	9 Run reverse (CCW)	<p>Trigger bit = 0-1 edge: Motor is started in backward rotating direction (CCW). Trigger bit = 1-0 edge: Motor is stopped again.</p> <p>Notes:</p> <ul style="list-style-type: none"> The stop method can be selected in 0x2838:003 (P203.03). In the case of a bipolar setpoint selection (e.g. ± 10 V), the function is executed irrespective of the rotating direction. The rotating direction is determined by the sign of the setpoint. The function also serves to realise an automatic start after switch-on. ▶ Starting performance 126 The "Invert rotation [13]" function can be used in connection with this function.



Configuring the network

General network settings

Parameter	Name / value range / [default setting]	Info
13	Invert rotation	Trigger bit = 1: the setpoint specified is inverted (i. e. the sign is inverted). Trigger bit = 0: no action / deactivate function again.
14	Activate AI1 setpoint	Trigger bit = 1: analog input 1 is used as setpoint source (if the trigger bit assigned has the highest setpoint priority). Trigger bit = 0: no action / deactivate function again. ▶ Analog input 1 □ 568
15	Activate AI2 setpoint	Trigger bit = 1: analog input 2 is used as setpoint source (if the trigger bit assigned has the highest setpoint priority). Trigger bit = 0: no action / deactivate function again. ▶ Analog input 2 □ 572
17	Activate network setpoint	Trigger bit = 1: the network is used as setpoint source (if the trigger bit assigned has the highest setpoint priority). Trigger bit = 0: no action / deactivate function again.
18	Activate preset (bit 0)	Selection bits for bit coded selection and activation of a parameterised setpoint (preset). ▶ Setpoint source of preset setpoints □ 522
19	Activate preset (bit 1)	
20	Activate preset (bit 2)	
21	Activate preset (bit 3)	
26	Activate segment 1 setpoint (from version 03.00)	Selection bits for bit coded selection and activation of a parameterised segment setpoint. Notes: <ul style="list-style-type: none"> • During normal operation (no active sequence), this function serves to activate the setpoint of a segment (instead of an entire sequence in the sequencer operation). • This function is not intended for the use in the sequencer operation. ▶ Setpoint source segment setpoints □ 532
27	Activate segment 2 setpoint (from version 03.00)	
28	Activate segment 3 setpoint (from version 03.00)	
29	Activate segment 4 setpoint (from version 03.00)	
30	Run/abort sequence (from version 03.00)	Trigger bit = 1: Start selected sequence. Trigger bit = 0: Abort sequence. Notes: <ul style="list-style-type: none"> • The assigned trigger bit must remain set to "1" for the duration of the sequence. • If the trigger bit is reset to "0", the sequence is aborted. In this case, the standard setpoint or the setpoint source selected via setpoint change-over is active again. • A sequence is selected in a binary-coded fashion via the trigger bits assigned to the four functions "Select sequence (bit 0) [50]" ... "Select sequence (bit 3) [53]". ▶ Sequencer □ 462
32	Next sequence step (from version 03.00)	Trigger bit = 0 \uparrow 1 (edge): Next sequence step. Trigger bit = 1 \downarrow 0 (edge): No action. Notes: <ul style="list-style-type: none"> • The execution of the current step is completed even if the time parameterised for the segment has not elapsed yet. • The function is only relevant for Sequencer mode 0x4025 (P800.00) = "Step operation [2]" or "Time & step operation [3]". • A jump to the next sequence step is not possible if the sequence pauses, the sequence is suspended or the final segment is executed. ▶ Sequencer □ 462
33	Pause sequence (from version 03.00)	Trigger bit = 1: Pause sequence. Trigger bit = 0: Continue sequence. Notes: <ul style="list-style-type: none"> • During the pause, the sequence stops in the current step. The expiration of the time set for the segment is stopped. • The sequencer setpoint continues to remain active. ▶ Sequencer □ 462
34	Suspend sequence (from version 03.00)	Trigger bit = 1: Suspend sequence. Trigger bit = 0: Continue sequence. Notes: <ul style="list-style-type: none"> • This function serves to temporarily change over to the standard setpoint or the setpoint source selected via setpoint change-over. • The sequence is continued at the point where it was suspended. ▶ Sequencer □ 462

Configuring the network

General network settings



Parameter	Name / value range / [default setting]	Info
35	Stop sequence (from version 03.00)	<p>Trigger bit = 0$\overline{1}$ (edge): Stop sequence. Trigger bit = 1$\overline{0}$ (edge): No action.</p> <p>Notes:</p> <ul style="list-style-type: none"> If the sequence is stopped, it is jumped to the final segment. The further execution depends on the selected End of sequence mode 0x402F (P824.00). <p>▶ Sequencer □ 462</p>
36	Abort sequence (from version 03.00)	<p>Trigger bit = 0$\overline{1}$ (edge): Abort sequence. Trigger bit = 1$\overline{0}$ (edge): No action.</p> <p>Notes:</p> <ul style="list-style-type: none"> This function serves to directly stop the sequence without the final segment being executed. In this case, the standard setpoint or the set-point source selected via setpoint change-over is active again. <p>▶ Sequencer □ 462</p>
39	Activate ramp 2	<p>Trigger bit = 1: activate acceleration time 2 and deceleration time 2 manually. Trigger bit = 0: no action / deactivate function again.</p> <p>▶ Frequency limits and ramp times □ 129</p>
40	Load parameter set	<p>Trigger bit = 0-1 edge: parameter change-over to the value set selected via "Select parameter set (bit 0)" and "Select parameter set (bit 1)". Trigger bit = 0: no action.</p> <p>Notes:</p> <ul style="list-style-type: none"> The activation method for the "Parameter change-over" function can be selected in 0x4046 (P755.00). <p>▶ Parameter change-over □ 412</p>
41	Select parameter set (bit 0)	<p>Selection bits for the "Parameter change-over" function.</p> <p>▶ Parameter change-over □ 412</p>
42	Select parameter set (bit 1)	
43	Activate fault 1	<p>Trigger bit = 1: Trigger user-defined error 1. Trigger bit = 0: no action.</p> <p>Notes:</p> <ul style="list-style-type: none"> After the error is triggered, the motor is brought to a standstill with the quick stop ramp. The inverter is then disabled. <p>Associated error code:</p> <ul style="list-style-type: none"> 25249 0x62A1 - Network: user fault 1
44	Activate fault 2	<p>Trigger bit = 1: Trigger user-defined error 2. Trigger bit = 0: no action.</p> <p>Notes:</p> <ul style="list-style-type: none"> After the error is triggered, the motor is brought to a standstill with the quick stop ramp. The inverter is then disabled. <p>Associated error code:</p> <ul style="list-style-type: none"> 25250 0x62A2 - Network: user fault 2
45	Deactivate PID controlling	<p>Trigger bit = 1: If PID control is activated, ignore PID control and drive the motor in speed-controlled manner. Trigger bit = 0: If PID control is activated, drive the motor with PID control.</p> <p>Notes:</p> <ul style="list-style-type: none"> The PID control can be activated in 0x4020:001 (P600.01). <p>▶ Configuring the process controller □ 356</p>
46	Set PID output to 0	<p>Trigger bit = 1: If PID control is activated, I component and the output of the PID controller are set to 0 and the internal control algorithm is stopped. The PID control remains active. Trigger bit = 0: No action / deactivate function again.</p> <p>▶ Configuring the process controller □ 356</p>
47	Inhibit PID I-component	<p>Trigger bit = 1: If the PID control is activated, the I component of the PID controller is set to 0 and the integration process is stopped. Trigger bit = 0: No action / deactivate function again.</p> <p>▶ Configuring the process controller □ 356</p>



Configuring the network

General network settings

Parameter	Name / value range / [default setting]	Info
	48 Activate PID influence ramp	<p>Trigger bit = 1: the influence of the process controller is shown by means of a ramp.</p> <p>Trigger bit = 0 or not connected: the influence of the process controller is shown by means of a ramp.</p> <p>Notes:</p> <ul style="list-style-type: none"> The influence of the process controller is always active (not only when PID control is activated). Acceleration time for showing the influence of the process controller can be set in 0x404C:001 (P607.01). Deceleration time for hiding the influence of the process controller can be set in 0x404C:002 (P607.02). <p>▶ Configuring the process controller □ 356</p>
	49 Release holding brake	<p>Trigger bit = 1: Release holding brake manually.</p> <p>Trigger bit = 0: No action.</p> <p>Notes:</p> <ul style="list-style-type: none"> The manually triggered "Release holding brake" command has a direct impact on the "Release holding brake [115]" trigger. Thus, the holding brake can be manually released if the power section is switched off. The responsibility for a manual release of the holding brake has the external trigger source for the "Release holding brake" command. <p>▶ Holding brake control □ 429</p>
	50 Select sequence (bit 0)	Selection bits for bit coded selection of a sequence.
	51 Select sequence (bit 1)	<p>Notes:</p> <ul style="list-style-type: none"> The selected sequence is not started automatically. For a status-controlled start, the function "Run/abort sequence [30]" is available. <p>▶ Sequencer control functions □ 559</p>
	52 Select sequence (bit 2)	
	53 Select sequence (bit 3)	
	54 Position counter reset	<p>Trigger bit = 1: Reset position counter manually.</p> <p>Trigger bit = 0: No action.</p> <p>▶ Position counter □ 447</p>
0x400E:002 (P505.02)	NetWordIN1 function: Bit 1 (NetWordIN1 fct.: NetWordIN1.01)	Definition of the function that is to be triggered via bit 1 of the mappable NetWordIN1 data word.
	<ul style="list-style-type: none"> Setting can only be changed if the inverter is inhibited. For further possible settings, see parameter 0x400E:001 (P505.01). □ 201 <p>0 Not active</p>	Trigger bit without any function.
0x400E:003 (P505.03)	NetWordIN1 function: Bit 2 (NetWordIN1 fct.: NetWordIN1.02)	Definition of the function that is to be triggered via bit 2 of the mappable NetWordIN1 data word.
	<ul style="list-style-type: none"> Setting can only be changed if the inverter is inhibited. For further possible settings, see parameter 0x400E:001 (P505.01). □ 201 <p>3 Activate quick stop</p>	<p>Trigger bit = 1: "Quick stop" function activated.</p> <p>Trigger bit = 0: no action / deactivate function again.</p> <p>Notes:</p> <ul style="list-style-type: none"> The "Quick stop" function brings the motor to a standstill within the deceleration time set in 0x291C (P225.00). The "Quick stop" function has a higher priority than the "Run" function.
0x400E:004 (P505.04)	NetWordIN1 function: Bit 3 (NetWordIN1 fct.: NetWordIN1.03)	Definition of the function that is to be triggered via bit 3 of the mappable NetWordIN1 data word.
	<ul style="list-style-type: none"> Setting can only be changed if the inverter is inhibited. For further possible settings, see parameter 0x400E:001 (P505.01). □ 201 <p>0 Not active</p>	Trigger bit without any function.

Configuring the network

General network settings



Parameter	Name / value range / [default setting]	Info
0x400E:005 (P505.05)	NetWordIN1 function: Bit 4 (NetWordIN1 fct.: NetWordIN1.04) <ul style="list-style-type: none"> Setting can only be changed if the inverter is inhibited. For further possible settings, see parameter 0x400E:001 (P505.01). □ 201 	Definition of the function that is to be triggered via bit 4 of the mappable NetWordIN1 data word.
	8 Run forward (CW)	Trigger bit = 0-1 edge: Motor is started in forward rotating direction (CW). Trigger bit = 1-0 edge: Motor is stopped again. Notes: <ul style="list-style-type: none"> The stop method can be selected in 0x2838:003 (P203.03). In the case of a bipolar setpoint selection (e.g. ± 10 V), the function is executed irrespective of the rotating direction. The rotating direction is determined by the sign of the setpoint. The function also serves to realise an automatic start after switch-on. <ul style="list-style-type: none"> ▶ Starting performance □ 126 The "Invert rotation [13]" function can be used in connection with this function.
0x400E:006 (P505.06)	NetWordIN1 function: Bit 5 (NetWordIN1 fct.: NetWordIN1.05) <ul style="list-style-type: none"> Setting can only be changed if the inverter is inhibited. For further possible settings, see parameter 0x400E:001 (P505.01). □ 201 	Definition of the function that is to be triggered via bit 5 of the mappable NetWordIN1 data word.
	18 Activate preset (bit 0)	Selection bits for bit coded selection and activation of a parameterised setpoint (preset). ▶ Setpoint source of preset setpoints □ 522
0x400E:007 (P505.07)	NetWordIN1 function: Bit 6 (NetWordIN1 fct.: NetWordIN1.06) <ul style="list-style-type: none"> Setting can only be changed if the inverter is inhibited. For further possible settings, see parameter 0x400E:001 (P505.01). □ 201 	Definition of the function that is to be triggered via bit 6 of the mappable NetWordIN1 data word.
	19 Activate preset (bit 1)	Selection bits for bit coded selection and activation of a parameterised setpoint (preset). ▶ Setpoint source of preset setpoints □ 522
0x400E:008 (P505.08)	NetWordIN1 function: Bit 7 (NetWordIN1 fct.: NetWordIN1.07) <ul style="list-style-type: none"> Setting can only be changed if the inverter is inhibited. For further possible settings, see parameter 0x400E:001 (P505.01). □ 201 	Definition of the function that is to be triggered via bit 7 of the mappable NetWordIN1 data word.
	4 Reset error	Trigger bit = 0-1 edge: Active error is reset (acknowledged) if the error condition is not active anymore and the error is resettable. Trigger bit = 0: No action. Notes: <ul style="list-style-type: none"> After resetting the error, a new enable/start command is required to restart the motor. ▶ Error handling □ 113
0x400E:009 (P505.09)	NetWordIN1 function: Bit 8 (NetWordIN1 fct.: NetWordIN1.08) <ul style="list-style-type: none"> Setting can only be changed if the inverter is inhibited. For further possible settings, see parameter 0x400E:001 (P505.01). □ 201 	Definition of the function that is to be triggered via bit 8 of the mappable NetWordIN1 data word.
	0 Not active	Trigger bit without any function.



Parameter	Name / value range / [default setting]	Info
0x400E:010 (P505.10)	NetWordIN1 function: Bit 9 (NetWordIN1 fct.: NetWordIN1.09) <ul style="list-style-type: none"> Setting can only be changed if the inverter is inhibited. For further possible settings, see parameter 0x400E:001 (P505.01). 201 	Definition of the function that is to be triggered via bit 9 of the mappable NetWordIN1 data word.
	5 Activate DC braking	Trigger bit = 1: "DC braking" function activated. Trigger bit = 0: no action / deactivate function again. ▶ DC braking 386
0x400E:011 (P505.11)	NetWordIN1 function: Bit 10 (NetWordIN1 fct.: NetWordIN1.10) <ul style="list-style-type: none"> Setting can only be changed if the inverter is inhibited. For further possible settings, see parameter 0x400E:001 (P505.01). 201 	Definition of the function that is to be triggered via bit 10 of the mappable NetWordIN1 data word.
	0 Not active	Trigger bit without any function.
0x400E:012 (P505.12)	NetWordIN1 function: Bit 11 (NetWordIN1 fct.: NetWordIN1.11) <ul style="list-style-type: none"> Setting can only be changed if the inverter is inhibited. For further possible settings, see parameter 0x400E:001 (P505.01). 201 	Definition of the function that is to be triggered via bit 11 of the mappable NetWordIN1 data word.
	0 Not active	Trigger bit without any function.
0x400E:013 (P505.13)	NetWordIN1 function: Bit 12 (NetWordIN1 fct.: NetWordIN1.12) <ul style="list-style-type: none"> Setting can only be changed if the inverter is inhibited. For further possible settings, see parameter 0x400E:001 (P505.01). 201 	Definition of the function that is to be triggered via bit 12 of the mappable NetWordIN1 data word.
	13 Invert rotation	Trigger bit = 1: the setpoint specified is inverted (i. e. the sign is inverted). Trigger bit = 0: no action / deactivate function again.
0x400E:014 (P505.14)	NetWordIN1 function: Bit 13 (NetWordIN1 fct.: NetWordIN1.13) <ul style="list-style-type: none"> Setting can only be changed if the inverter is inhibited. For further possible settings, see parameter 0x400E:001 (P505.01). 201 	Definition of the function that is to be triggered via bit 13 of the mappable NetWordIN1 data word.
	0 Not active	Trigger bit without any function.
0x400E:015 (P505.15)	NetWordIN1 function: Bit 14 (NetWordIN1 fct.: NetWordIN1.14) <ul style="list-style-type: none"> Setting can only be changed if the inverter is inhibited. For further possible settings, see parameter 0x400E:001 (P505.01). 201 	Definition of the function that is to be triggered via bit 14 of the mappable NetWordIN1 data word.
	0 Not active	Trigger bit without any function.
0x400E:016 (P505.16)	NetWordIN1 function: Bit 15 (NetWordIN1 fct.: NetWordIN1.15) <ul style="list-style-type: none"> Setting can only be changed if the inverter is inhibited. For further possible settings, see parameter 0x400E:001 (P505.01). 201 	Definition of the function that is to be triggered via bit 15 of the mappable NetWordIN1 data word.
	0 Not active	Trigger bit without any function.

Configuring the network

General network settings



Parameter	Name / value range / [default setting]	Info	
0x2631:001 (P400.01)	Function list: Enable inverter (Function list: Enable inverter) <ul style="list-style-type: none"> Setting can only be changed if the inverter is inhibited. 	Assignment of a trigger for the "Enable inverter" function. Trigger = TRUE: The inverter is enabled (unless there is another cause for inverter disable). Trigger = FALSE: The inverter is disabled. Notes: <ul style="list-style-type: none"> This function must be set to TRUE to start the motor. Either via an assigned digital input or by default setting "Constant TRUE [1]". Changing to the inhibited state causes an immediate stop of the motor, regardless of the stop method set in 0x2838:003 (P203.03). The motor becomes torqueless and coasts down as a function of the mass inertia of the machine. The cause(s) that are active for the disabled state are shown in 0x282A:001 (P126.01). 	
	0	Not connected	No trigger assigned (trigger is constantly FALSE).
	1	Constant TRUE	Trigger is constantly TRUE.
	11	Digital input 1	State of X3/DI1, taking an inversion set in 0x2632:001 (P411.01) into consideration.
	12	Digital input 2	State of X3/DI2, taking an inversion set in 0x2632:002 (P411.02) into consideration.
	13	Digital input 3	State of X3/DI3, taking an inversion set in 0x2632:003 (P411.03) into consideration.
	14	Digital input 4	State of X3/DI4, taking an inversion set in 0x2632:004 (P411.04) into consideration.
	15	Digital input 5	State of X3/DI5, taking an inversion set in 0x2632:005 (P411.05) into consideration.
	16	Digital input 6	State of X3/DI6, taking an inversion set in 0x2632:006 (P411.06) into consideration. Digital input 6 is only available in the Control Unit (CU) with application I/O.
	17	Digital input 7	State of X3/DI7, taking an inversion set in 0x2632:007 (P411.07) into consideration. Digital input 7 is only available in the Control Unit (CU) with application I/O.
	50	Running	TRUE if inverter and start are enabled and output frequency > 0.2 Hz. Otherwise FALSE.
	51	Ready for operation	TRUE if inverter is ready for operation (no error active, no STO active and DC-bus voltage ok). Otherwise FALSE.
	53	Stop active	TRUE if inverter is enabled and motor is not started and output frequency = 0.
	54	Quick stop active	TRUE if quick stop is active. Otherwise FALSE.
	58	Device warning active	TRUE if warning is active. Otherwise FALSE. <ul style="list-style-type: none"> A warning has no impact on the operating status of the inverter. A warning is reset automatically if the cause has been eliminated.
59	Device fault active	TRUE if a fault is active. Otherwise FALSE. <ul style="list-style-type: none"> In the event of a fault, the motor is brought to a standstill with the quick stop ramp. The inverter is then disabled. Exception: In case of a serious fault, the inverter is disabled immediately. The motor becomes torqueless (coasts). The error state will be left automatically if the error condition is not active anymore. The restart behaviour after trouble can be configured. ▶ Automatic restart □ 441 	
60	Heatsink temperature warning active	TRUE if current heatsink temperature > warning threshold for temperature monitoring. Otherwise FALSE. <ul style="list-style-type: none"> Display of the current heatsink temperature in 0x2D84:001 (P117.01). Setting of the warning threshold in 0x2D84:002. 	
69	Rotational direction reversed	TRUE if output frequency is negative. Otherwise FALSE.	
70	Frequency threshold exceeded	TRUE if current output frequency > frequency threshold. Otherwise FALSE. <ul style="list-style-type: none"> Display of the current output frequency in 0x2DDD (P100.00). Setting Frequency threshold in 0x4005 (P412.00). ▶ Frequency threshold for "Frequency threshold exceeded" trigger □ 564 	



Configuring the network

General network settings

Parameter	Name / value range / [default setting]	Info
71	Actual speed = 0	TRUE if current output frequency = 0 Hz (± 0.01 Hz), irrespective of the operating mode. Otherwise FALSE. • Display of the current output frequency in 0x2DDD (P100.00) .
78	Current limit reached	TRUE if current motor current \geq maximum current. Otherwise FALSE. • Display of the present motor current in 0x2D88 (P104.00) . • Setting for the maximum current in 0x6073 (P324.00) .
79	Torque limit reached (from version 02.00)	TRUE if torque limit has been reached or exceeded. Otherwise FALSE. • Setting "Positive torque limit" in 0x60E0 . • Setting "Negative torque limit" in 0x60E1 .
81	Error of analog input 1 active	TRUE if the monitoring of the input signal at the analog input 1 has responded. Otherwise FALSE. This trigger is set as a function of the following settings: • Monitoring threshold 0x2636:008 (P430.08) • Monitoring condition 0x2636:009 (P430.09) The setting of the Error response in 0x2636:010 (P430.10) has no effect on this trigger. ▶ Analog input 1 📄 568
82	Error of analog input 2 active	TRUE if the monitoring of the input signal at the analog input 2 has responded. Otherwise FALSE. This trigger is set as a function of the following settings: • Monitoring threshold 0x2637:008 (P431.08) • Monitoring condition 0x2637:009 (P431.09) The setting of the Error response in 0x2637:010 (P431.10) has no effect on this trigger. ▶ Analog input 2 📄 572
83	Load loss detected	TRUE if actual motor current < threshold for load loss detection after delay time of the load loss detection has elapsed. Otherwise FALSE. • Display of the present motor current in 0x6078 (P103.00) . • Setting Threshold in 0x4006:001 (P710.01) . • Setting Deceleration in 0x4006:002 (P710.02) . ▶ Load loss detection 📄 397
102	Sequence suspended (from version 03.00)	Status signal of the "sequencer" function: TRUE if the sequence is currently suspended. ▶ Sequencer 📄 462
103	Sequence done (from version 03.00)	Status signal of the "sequencer" function: TRUE if the sequence is completed (final segment has been passed through). ▶ Sequencer 📄 462
104	Local control active	TRUE if local keypad control ("LOC") active. Otherwise FALSE.
105	Remote control active	TRUE if remote control ("REM") via terminals, network, etc. active. Otherwise FALSE.
106	Manual setpoint selection active	TRUE if manual setpoint selection ("MAN") via keypad active. Otherwise FALSE. • Selection of the trigger for the "Activate keypad setpoint" function in 0x2631:016 (P400.16) .
107	Automatic setpoint selection active	TRUE if automatic setpoint selection ("AUTO") via terminals, network, etc. active. Otherwise FALSE.

Configuring the network

General network settings



Parameter	Name / value range / [default setting]	Info
0x2631:002 (P400.02)	Function list: Run (Function list: Run) <ul style="list-style-type: none"> Setting can only be changed if the inverter is inhibited. For further possible settings, see parameter 0x2631:001 (P400.01). □ 500 	Assignment of a trigger for the "Run" function. Function 1: Start / stop motor (default setting) Function 1 is active if no further start commands (start forward/start reverse) have been connected to triggers, no keypad control is active and no network control is active. Trigger = TRUE: Let motor rotate forward (CW). Trigger = FALSE: Stop motor. Notes to function 1: <ul style="list-style-type: none"> If "Enable inverter" 0x2631:001 (P400.01) is set = "Constant TRUE [1]", the only permissible trigger for this function is a digital input in order that the motor can be stopped again any time. The stop method can be selected in 0x2838:003 (P203.03). The function also serves to realise an automatic start after switch-on. <ul style="list-style-type: none"> ▶ Starting performance □ 126 Function 2: Start enable/stop motor Function 2 is active if further start commands have been connected to triggers, keypad control is active or network control is active. Trigger = TRUE: Start commands of the active control source are enabled. Trigger = FALSE: Stop motor. Notes to function 2: <ul style="list-style-type: none"> If no separate start enable is required for the application, the trigger "Constant TRUE [1]" must be set. The stop method can be selected in 0x2838:003 (P203.03).
	11 Digital input 1	State of X3/DI1, taking an inversion set in 0x2632:001 (P411.01) into consideration.
0x2631:003 (P400.03)	Function list: Activate quick stop (Function list: Quick stop) <ul style="list-style-type: none"> Setting can only be changed if the inverter is inhibited. For further possible settings, see parameter 0x2631:001 (P400.01). □ 500 	Assignment of a trigger for the "Activate quick stop" function. Trigger = TRUE: Activate quick stop. Trigger = FALSE: Deactivate quick stop. Notes: <ul style="list-style-type: none"> The "Quick stop" function brings the motor to a standstill within the deceleration time set in 0x291C (P225.00).
	0 Not connected	No trigger assigned (trigger is constantly FALSE).
0x2631:004 (P400.04)	Function list: Reset fault (Function list: Reset fault) <ul style="list-style-type: none"> For further possible settings, see parameter 0x2631:001 (P400.01). □ 500 	Assignment of a trigger for the "Reset fault" function. Trigger = FALSE↗TRUE (edge): Active error is reset (acknowledged) if the error condition is not active anymore and the error is resettable. Trigger = FALSE: no action.
	12 Digital input 2	State of X3/DI2, taking an inversion set in 0x2632:002 (P411.02) into consideration.
0x2631:005 (P400.05)	Function list: Activate DC braking (Function list: DC braking) <ul style="list-style-type: none"> For further possible settings, see parameter 0x2631:001 (P400.01). □ 500 	Assignment of a trigger for the "Activate DC braking" function. Trigger = TRUE: Activate DC braking. Trigger = FALSE: Deactivate DC braking. ⚠ CAUTION! DC braking remains active as long as the trigger is set to TRUE. <ul style="list-style-type: none"> ▶ DC braking □ 386
	0 Not connected	No trigger assigned (trigger is constantly FALSE).



Parameter	Name / value range / [default setting]	Info
0x2631:010 (P400.10)	Function list: Jog forward (CW) (Function list: Jog forward) <ul style="list-style-type: none"> Setting can only be changed if the inverter is inhibited. For further possible settings, see parameter 0x2631:001 (P400.01). □ 500 	Assignment of a trigger for the "Jog forward (CW)" function. Trigger = TRUE: Let motor rotate forward with preset 5. Trigger = FALSE: Stop motor. ⚠ CAUTION! The jog operation has a higher priority than the "Run" function, all other start commands and the keypad key . <ul style="list-style-type: none"> If jog operation is active, the motor cannot be stopped with the previously mentioned functions! However, jog operation can be interrupted by the "Quick stop" function. Notes: <ul style="list-style-type: none"> The preset value 5 can be set in 0x2911:005 (P450.05). The stop method can be selected in 0x2838:003 (P203.03). If "Jog forward (CW)" and "Jog reverse (CCW)" are activated at the same time, the motor is stopped using the stop method and jog operation must be triggered again. Jog operation cannot be started automatically. The "Start at power-up" option in 0x2838:002 (P203.02) does not apply to jog operation.
	0 Not connected	No trigger assigned (trigger is constantly FALSE).
0x2631:011 (P400.11)	Function list: Jog reverse (CCW) (Function list: Jog reverse) <ul style="list-style-type: none"> Setting can only be changed if the inverter is inhibited. For further possible settings, see parameter 0x2631:001 (P400.01). □ 500 	Assignment of a trigger for the "Jog reverse (CCW)" function. Trigger = TRUE: Let motor rotate backward with preset 6. Trigger = FALSE: Stop motor. ⚠ CAUTION! The jog operation has a higher priority than the "Run" function, all other start commands and the keypad key . <ul style="list-style-type: none"> If jog operation is active, the motor cannot be stopped with the previously mentioned functions! However, jog operation can be interrupted by the "Quick stop" function. Notes: <ul style="list-style-type: none"> The preset value 6 can be set in 0x2911:006 (P450.06). The stop method can be selected in 0x2838:003 (P203.03). If "Jog forward (CW)" and "Jog reverse (CCW)" are activated at the same time, the motor is stopped using the stop method and jog operation must be triggered again. Jog operation cannot be started automatically. The "Start at power-up" option in 0x2838:002 (P203.02) does not apply to jog operation.
	0 Not connected	No trigger assigned (trigger is constantly FALSE).
0x2631:012 (P400.12)	Function list: Activate keypad control (Function list: Keypad control) <ul style="list-style-type: none"> For further possible settings, see parameter 0x2631:001 (P400.01). □ 500 	Assignment of a trigger for the "Activate keypad control" function. Trigger = TRUE: activate keypad as control source. Trigger = FALSE: no action / deactivate keypad as control source again.
	0 Not connected	No trigger assigned (trigger is constantly FALSE).
0x2631:017 (P400.17)	Function list: Activate network setpoint (Function list: Setp: Network) <ul style="list-style-type: none"> From version 02.01 For further possible settings, see parameter 0x2631:001 (P400.01). □ 500 	Assignment of a trigger for the "Activate network setpoint" function. Trigger = TRUE: the network is used as setpoint source (if the trigger assigned has the highest setpoint priority). Trigger = FALSE: no action / deactivate function again.
	0 Not connected	No trigger assigned (trigger is constantly FALSE).
	116 Network setpoint active (from version 02.00)	TRUE if a change-over to network setpoint is requested via bit 6 of the AC drive control word 0x400B:001 (P592.01) . Otherwise FALSE. Notes: <ul style="list-style-type: none"> Set this selection if the network setpoint is to be activated via bit 6 of the AC drive control word. The AC drive control word can be used with any communication protocol. ▶ AC Drive Profile □ 221

Configuring the network

General network settings



Parameter	Name / value range / [default setting]	Info
0x2631:037 (P400.37)	Function list: Activate network control (Function list: Network control) • For further possible settings, see parameter 0x2631:001 (P400.01) . 500	Assignment of a trigger for the "Activate network control" function. Trigger = TRUE: Activate network control. Trigger = FALSE: No action / deactivate network control again.
	0 Not connected	No trigger assigned (trigger is constantly FALSE).
	114 Network control active (from version 02.00)	TRUE if the network control is requested via bit 5 of the AC drive control word 0x400B:001 (P592.01) . Otherwise FALSE. Notes: • Set this selection if the network control is to be activated via bit 5 of the AC drive control word. • The AC drive control word can be used with any communication protocol. AC Drive Profile 221
0x2631:043 (P400.43)	Function list: Activate fault 1 (Function list: Fault 1) • For further possible settings, see parameter 0x2631:001 (P400.01) . 500	Assignment of a trigger for the "Activate fault 1" function. Trigger = TRUE: Trigger user-defined error 1. Trigger = FALSE: no action. Notes: • After the error is triggered, the motor is brought to a standstill with the quick stop ramp. The inverter is then disabled. Associated error code: • 25217 0x6281 - User-defined fault 1
	0 Not connected	No trigger assigned (trigger is constantly FALSE).
0x2631:044 (P400.44)	Function list: Activate fault 2 (Function list: Fault 2) • For further possible settings, see parameter 0x2631:001 (P400.01) . 500	Assignment of a trigger for the "Activate fault 2" function. Trigger = TRUE: Trigger user-defined error 2. Trigger = FALSE: no action. Notes: • After the error is triggered, the motor is brought to a standstill with the quick stop ramp. The inverter is then disabled. Associated error code: • 25218 0x6282 - User-defined fault 2
	0 Not connected	No trigger assigned (trigger is constantly FALSE).
0x2634:010 (P420.10)	Digital outputs function: NetWordOUT1 - bit 0 (Dig.out.function: NetWordOUT1.00) • For further possible settings, see parameter 0x2634:001 (P420.01) . 574	Assignment of a trigger to bit 0 of NetWordOUT1. Trigger = FALSE: bit set to 0. Trigger = TRUE: bit set to 1.
	51 Ready for operation	TRUE if inverter is ready for operation (no error active, no STO active and DC-bus voltage ok). Otherwise FALSE.
0x2634:011 (P420.11)	Digital outputs function: NetWordOUT1 - bit 1 (Dig.out.function: NetWordOUT1.01) • For further possible settings, see parameter 0x2634:001 (P420.01) . 574	Assignment of a trigger to bit 1 of NetWordOUT1. Trigger = FALSE: bit set to 0. Trigger = TRUE: bit set to 1.
	0 Not connected	No trigger assigned (trigger is constantly FALSE).
0x2634:012 (P420.12)	Digital outputs function: NetWordOUT1 - bit 2 (Dig.out.function: NetWordOUT1.02) • For further possible settings, see parameter 0x2634:001 (P420.01) . 574	Assignment of a trigger to bit 2 of NetWordOUT1. Trigger = FALSE: bit set to 0. Trigger = TRUE: bit set to 1.
	52 Operation enabled	TRUE if inverter and start are enabled. Otherwise FALSE.
0x2634:013 (P420.13)	Digital outputs function: NetWordOUT1 - bit 3 (Dig.out.function: NetWordOUT1.03) • For further possible settings, see parameter 0x2634:001 (P420.01) . 574	Assignment of a trigger to bit 3 of NetWordOUT1. Trigger = FALSE: bit set to 0. Trigger = TRUE: bit set to 1.
	56 Error active	TRUE if error is active. Otherwise FALSE.
0x2634:014 (P420.14)	Digital outputs function: NetWordOUT1 - bit 4 (Dig.out.function: NetWordOUT1.04) • For further possible settings, see parameter 0x2634:001 (P420.01) . 574	Assignment of a trigger to bit 4 of NetWordOUT1. Trigger = FALSE: bit set to 0. Trigger = TRUE: bit set to 1.
	0 Not connected	No trigger assigned (trigger is constantly FALSE).

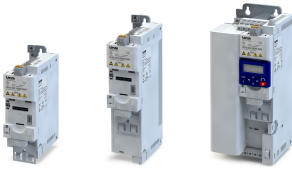

Parameter	Name / value range / [default setting]	Info
0x2634:015 (P420.15)	Digital outputs function: NetWordOUT1 - bit 5 (Dig.out.function: NetWordOUT1.05) • For further possible settings, see parameter 0x2634:001 (P420.01) . 574	Assignment of a trigger to bit 5 of NetWordOUT1. Trigger = FALSE: bit set to 0. Trigger = TRUE: bit set to 1.
	54 Quick stop active	TRUE if quick stop is active. Otherwise FALSE.
0x2634:016 (P420.16)	Digital outputs function: NetWordOUT1 - bit 6 (Dig.out.function: NetWordOUT1.06) • For further possible settings, see parameter 0x2634:001 (P420.01) . 574	Assignment of a trigger to bit 6 of NetWordOUT1. Trigger = FALSE: bit set to 0. Trigger = TRUE: bit set to 1.
	50 Running	TRUE if inverter and start are enabled and output frequency > 0.2 Hz. Otherwise FALSE.
0x2634:017 (P420.17)	Digital outputs function: NetWordOUT1 - bit 7 (Dig.out.function: NetWordOUT1.07) • For further possible settings, see parameter 0x2634:001 (P420.01) . 574	Assignment of a trigger to bit 7 of NetWordOUT1. Trigger = FALSE: bit set to 0. Trigger = TRUE: bit set to 1.
	58 Device warning active	TRUE if warning is active. Otherwise FALSE. • A warning has no impact on the operating status of the inverter. • A warning is reset automatically if the cause has been eliminated.
0x2634:018 (P420.18)	Digital outputs function: NetWordOUT1 - bit 8 (Dig.out.function: NetWordOUT1.08) • For further possible settings, see parameter 0x2634:001 (P420.01) . 574	Assignment of a trigger to bit 8 of NetWordOUT1. Trigger = FALSE: bit set to 0. Trigger = TRUE: bit set to 1.
	0 Not connected	No trigger assigned (trigger is constantly FALSE).
0x2634:019 (P420.19)	Digital outputs function: NetWordOUT1 - bit 9 (Dig.out.function: NetWordOUT1.09) • For further possible settings, see parameter 0x2634:001 (P420.01) . 574	Assignment of a trigger to bit 9 of NetWordOUT1. Trigger = FALSE: bit set to 0. Trigger = TRUE: bit set to 1.
	0 Not connected	No trigger assigned (trigger is constantly FALSE).
0x2634:020 (P420.20)	Digital outputs function: NetWordOUT1 - bit 10 (Dig.out.function: NetWordOUT1.10) • For further possible settings, see parameter 0x2634:001 (P420.01) . 574	Assignment of a trigger to bit 10 of NetWordOUT1. Trigger = FALSE: bit set to 0. Trigger = TRUE: bit set to 1.
	72 Setpoint speed reached	TRUE if frequency setpoint reached. Otherwise FALSE.
0x2634:021 (P420.21)	Digital outputs function: NetWordOUT1 - bit 11 (Dig.out.function: NetWordOUT1.11) • For further possible settings, see parameter 0x2634:001 (P420.01) . 574	Assignment of a trigger to bit 11 of NetWordOUT1. Trigger = FALSE: bit set to 0. Trigger = TRUE: bit set to 1.
	78 Current limit reached	TRUE if current motor current \geq maximum current. Otherwise FALSE. • Display of the present motor current in 0x2D88 (P104.00) . • Setting for the maximum current in 0x6073 (P324.00) .
0x2634:022 (P420.22)	Digital outputs function: NetWordOUT1 - bit 12 (Dig.out.function: NetWordOUT1.12) • For further possible settings, see parameter 0x2634:001 (P420.01) . 574	Assignment of a trigger to bit 12 of NetWordOUT1. Trigger = FALSE: bit set to 0. Trigger = TRUE: bit set to 1.
	71 Actual speed = 0	TRUE if current output frequency = 0 Hz (\pm 0.01 Hz), irrespective of the operating mode. Otherwise FALSE. • Display of the current output frequency in 0x2DDD (P100.00) .
0x2634:023 (P420.23)	Digital outputs function: NetWordOUT1 - bit 13 (Dig.out.function: NetWordOUT1.13) • For further possible settings, see parameter 0x2634:001 (P420.01) . 574	Assignment of a trigger to bit 13 of NetWordOUT1. Trigger = FALSE: bit set to 0. Trigger = TRUE: bit set to 1.
	69 Rotational direction reversed	TRUE if output frequency is negative. Otherwise FALSE.

Configuring the network

General network settings



Parameter	Name / value range / [default setting]	Info
0x2634:024 (P420.24)	Digital outputs function: NetWordOUT1 - bit 14 (Dig.out.function: NetWordOUT1.14) <ul style="list-style-type: none"> For further possible settings, see parameter 0x2634:001 (P420.01). □ 574 	Assignment of a trigger to bit 14 of NetWordOUT1. Trigger = FALSE: bit set to 0. Trigger = TRUE: bit set to 1.
	115 Release holding brake	Trigger signal for releasing the holding brake (TRUE = release holding brake). Note! If this trigger is assigned to the relay or a digital output, the deceleration times set for the respective output are not effective (are internally set to "0"). Only the deceleration time set in 0x2820:012 (P712.12) for closing the holding brake influences in this case the time-dependent behaviour of the output. ▶ Holding brake control □ 429
0x2634:025 (P420.25)	Digital outputs function: NetWordOUT1 - bit 15 (Dig.out.function: NetWordOUT1.15) <ul style="list-style-type: none"> For further possible settings, see parameter 0x2634:001 (P420.01). □ 574 	Assignment of a trigger to bit 15 of NetWordOUT1. Trigger = FALSE: bit set to 0. Trigger = TRUE: bit set to 1.
	55 Safe torque off (STO) active	TRUE if the integrated safety system has triggered the "Safe torque off (STO)" function. Otherwise FALSE. ▶ Safe torque off (STO) □ 492



Parameter	Name / value range / [default setting]	Info
0x2860:001 (P201.01)	Frequency control: Default setpoint source (Std. setpoints: Freq. setp. src.)	Selection of the standard setpoint source for operating mode "MS: Velocity mode". <ul style="list-style-type: none"> The selected standard setpoint source is always active in the operating mode 0x6060 (P301.00) = "MS: Velocity mode [-2]" when no setpoint change-over to another setpoint source via corresponding triggers/functions is active. ▶ Setpoint change-over □ 514
	1 Keypad	The setpoint is specified locally by the keypad. <ul style="list-style-type: none"> Default setting: 0x2601:001 (P202.01) Use the ↑ and ↓ navigation keys to change the keypad setpoint (also during running operation).
	2 Analog input 1	The setpoint is defined as analog signal via the analog input 1. <ul style="list-style-type: none"> ▶ Analog input 1 □ 568
	3 Analog input 2	The setpoint is defined as analog signal via the analog input 2. <ul style="list-style-type: none"> ▶ Analog input 2 □ 572
	4 HTL input (from version 04.00)	The digital inputs DI3 and DI4 can be configured as HTL input to use an HTL encoder as setpoint encoder or define the setpoint as a reference frequency ("pulse train"). <ul style="list-style-type: none"> ▶ HTL input setpoint source □ 534
	5 Network	The setpoint is defined as process data object via the network. <ul style="list-style-type: none"> ▶ Configuring the network □ 199
	11 Frequency preset 1	For the setpoint selection, preset values can be parameterised and selected. <ul style="list-style-type: none"> ▶ Setpoint source of preset setpoints □ 522
	12 Frequency preset 2	
	13 Frequency preset 3	
	14 Frequency preset 4	
	15 Frequency preset 5	
	16 Frequency preset 6	
	17 Frequency preset 7	
	18 Frequency preset 8	
	19 Frequency preset 9	
	20 Frequency preset 10	
	21 Frequency preset 11	
	22 Frequency preset 12	
	23 Frequency preset 13	
	24 Frequency preset 14	
	25 Frequency preset 15	
	31 Segment preset 1 (from version 03.00)	For the setpoint selection, the segment presets parameterised for the "sequencer" function can be selected as well. <ul style="list-style-type: none"> ▶ Sequencer □ 462
	32 Segment preset 2 (from version 03.00)	
	33 Segment preset 3 (from version 03.00)	
	34 Segment preset 4 (from version 03.00)	
35 Segment preset 5 (from version 03.00)		
36 Segment preset 6 (from version 03.00)		
37 Segment preset 7 (from version 03.00)		
38 Segment preset 8 (from version 03.00)		
50 Motor potentiometer	The setpoint is generated by the "motor potentiometer" function. This function can be used as an alternative setpoint control which is controlled via two signals: "MOP setpoint up" and "MOP setpoint down". <ul style="list-style-type: none"> ▶ Motor potentiometer setpoint source (MOP) □ 528 	

Configuring the network

General network settings



Parameter	Name / value range / [default setting]	Info
0x2860:002 (P201.02)	PID control: Default setpoint source (Std. setpoints: PID setp. src.)	Selection of the standard setpoint source for the reference value of the PID control. <ul style="list-style-type: none"> The selected standard setpoint source is always active with an activated PID control when no setpoint change-over to another setpoint source via corresponding triggers/functions is active.
	1 Keypad	The setpoint is specified locally by the keypad. <ul style="list-style-type: none"> Default setting: 0x2601:002 (P202.02) Use the ↑ and ↓ navigation keys to change the keypad setpoint (also during running operation).
	2 Analog input 1	The setpoint is defined as analog signal via the analog input 1. ▶ Analog input 1 □ 568
	3 Analog input 2	The setpoint is defined as analog signal via the analog input 2. ▶ Analog input 2 □ 572
	4 HTL input (from version 04.00)	The digital inputs DI3 and DI4 can be configured as HTL input to use an HTL encoder as setpoint encoder or define the setpoint as a reference frequency ("pulse train"). ▶ HTL input setpoint source □ 534
	5 Network	The setpoint is defined as process data object via the network. ▶ Configuring the network □ 199
	11 PID preset 1	For the setpoint selection, preset values can be parameterised and selected. ▶ Setpoint source of preset setpoints □ 522
	12 PID preset 2	
	13 PID preset 3	
	14 PID preset 4	
	15 PID preset 5	
	16 PID preset 6	
	17 PID preset 7	
	18 PID preset 8	
	31 Segment preset 1 (from version 03.00)	For the setpoint selection, the segment presets parameterised for the "sequencer" function can be selected as well. ▶ Sequencer □ 462
	32 Segment preset 2 (from version 03.00)	
	33 Segment preset 3 (from version 03.00)	
	34 Segment preset 4 (from version 03.00)	
	35 Segment preset 5 (from version 03.00)	
	36 Segment preset 6 (from version 03.00)	
37 Segment preset 7 (from version 03.00)		
38 Segment preset 8 (from version 03.00)		
50 Motor potentiometer	The setpoint is generated by the "motor potentiometer" function. This function can be used as an alternative setpoint control which is controlled via two signals: "MOP setpoint up" and "MOP setpoint down". ▶ Motor potentiometer setpoint source (MOP) □ 528	
0x4008:001 (P590.01)	Process input words: NetWordIN1 (NetWordINx: NetWordIN1) 0x0000 ... 0x0000 ... 0xFFFF	Mappable data word for flexible control of the inverter via network.
	Bit 0 Mapping bit 0	Assignment of the function: 0x400E:001 (P505.01)
	Bit 1 Mapping bit 1	Assignment of the function: 0x400E:002 (P505.02)
	Bit 2 Mapping bit 2	Assignment of the function: 0x400E:003 (P505.03)
	Bit 3 Mapping bit 3	Assignment of the function: 0x400E:004 (P505.04)
	Bit 4 Mapping bit 4	Assignment of the function: 0x400E:005 (P505.05)
	Bit 5 Mapping bit 5	Assignment of the function: 0x400E:006 (P505.06)
	Bit 6 Mapping bit 6	Assignment of the function: 0x400E:007 (P505.07)
	Bit 7 Mapping bit 7	Assignment of the function: 0x400E:008 (P505.08)
	Bit 8 Mapping bit 8	Assignment of the function: 0x400E:009 (P505.09)
	Bit 9 Mapping bit 9	Assignment of the function: 0x400E:010 (P505.10)
	Bit 10 Mapping bit 10	Assignment of the function: 0x400E:011 (P505.11)
	Bit 11 Mapping bit 11	Assignment of the function: 0x400E:012 (P505.12)
	Bit 12 Mapping bit 12	Assignment of the function: 0x400E:013 (P505.13)
	Bit 13 Mapping bit 13	Assignment of the function: 0x400E:014 (P505.14)
	Bit 14 Mapping bit 14	Assignment of the function: 0x400E:015 (P505.15)
	Bit 15 Mapping bit 15	Assignment of the function: 0x400E:016 (P505.16)



Configuring the network

General network settings

Parameter	Name / value range / [default setting]	Info
0x400A:001 (P591.01)	Process output words: NetWordOUT1 (NetWordOUTx: NetWordOUT1) • Read only	Mappable data word for the output of status messages of the inverter via network.
	Bit 0 Mapping bit 0	Mappable data word for the output of status messages of the inverter via network. Assignment of the status message: 0x2634:010 (P420.10)
	Bit 1 Mapping bit 1	Mappable data word for the output of status messages of the inverter via network. Assignment of the status message: 0x2634:011 (P420.11)
	Bit 2 Mapping bit 2	Mappable data word for the output of status messages of the inverter via network. Assignment of the status message: 0x2634:012 (P420.12)
	Bit 3 Mapping bit 3	Mappable data word for the output of status messages of the inverter via network. Assignment of the status message: 0x2634:013 (P420.13)
	Bit 4 Mapping bit 4	Mappable data word for the output of status messages of the inverter via network. Assignment of the status message: 0x2634:014 (P420.14)
	Bit 5 Mapping bit 5	Mappable data word for the output of status messages of the inverter via network. Assignment of the status message: 0x2634:015 (P420.15)
	Bit 6 Mapping bit 6	Mappable data word for the output of status messages of the inverter via network. Assignment of the status message: 0x2634:016 (P420.16)
	Bit 7 Mapping bit 7	Mappable data word for the output of status messages of the inverter via network. Assignment of the status message: 0x2634:017 (P420.17)
	Bit 8 Mapping bit 8	Mappable data word for the output of status messages of the inverter via network. Assignment of the status message: 0x2634:018 (P420.18)
	Bit 9 Mapping bit 9	Mappable data word for the output of status messages of the inverter via network. Assignment of the status message: 0x2634:019 (P420.19)
	Bit 10 Mapping bit 10	Mappable data word for the output of status messages of the inverter via network. Assignment of the status message: 0x2634:020 (P420.20)
	Bit 11 Mapping bit 11	Mappable data word for the output of status messages of the inverter via network. Assignment of the status message: 0x2634:021 (P420.21)
	Bit 12 Mapping bit 12	Mappable data word for the output of status messages of the inverter via network. Assignment of the status message: 0x2634:022 (P420.22)
	Bit 13 Mapping bit 13	Mappable data word for the output of status messages of the inverter via network. Assignment of the status message: 0x2634:023 (P420.23)
	Bit 14 Mapping bit 14	Mappable data word for the output of status messages of the inverter via network. Assignment of the status message: 0x2634:024 (P420.24)
Bit 15 Mapping bit 15	Mappable data word for the output of status messages of the inverter via network. Assignment of the status message: 0x2634:025 (P420.25)	

Configuring the network

General network settings



Parameter	Name / value range / [default setting]	Info
0x400A:002 (P591.02)	Process output words: NetWordOUT2 (NetWordOUTx: NetWordOUT2)	Mappable data word for the output of messages of the "Sequencer" function via network.
	• Read only	Configuration of the messages:
	Bit 0 Mapping bit 0	• 0x4026:008: NetWordOUT2 value for sequencer segment 1
	Bit 1 Mapping bit 1	• 0x4027:008: NetWordOUT2 value for sequencer segment 2
	Bit 2 Mapping bit 2	• 0x4028:008: NetWordOUT2 value for sequencer segment 3
	Bit 3 Mapping bit 3	• 0x4029:008: NetWordOUT2 value for sequencer segment 4
	Bit 4 Mapping bit 4	• 0x402A:008: NetWordOUT2 value for sequencer segment 5
	Bit 5 Mapping bit 5	• 0x402B:008: NetWordOUT2 value for sequencer segment 6
	Bit 6 Mapping bit 6	• 0x402C:008: NetWordOUT2 value for sequencer segment 7
	Bit 7 Mapping bit 7	• 0x402D:008: NetWordOUT2 value for sequencer segment 8
	Bit 8 Mapping bit 8	• 0x402E:008: NetWordOUT2 value for final segment
	Bit 9 Mapping bit 9	
	Bit 10 Mapping bit 10	
	Bit 11 Mapping bit 11	
	Bit 12 Mapping bit 12	
	Bit 13 Mapping bit 13	
Bit 14 Mapping bit 14		
Bit 15 Mapping bit 15		



8.2 Predefined process data words

Process data are exchanged via cyclic data exchange between the network master and the inverter.

Details

For the cyclic data exchange, the inverter is provided with 24 network registers.

- 12 network registers are provided as input registers for data words from the network master to the inverter.
- 12 network registers are provided as output registers for data words from the inverter to the network master.
- Each network register is provided with a corresponding code that defines which parameters (or other data codes) are mapped to the network register.
- The input and output registers are divided into three blocks (A, B, C) in each case, featuring 4 successive data words, respectively:

Network register	
Input register	Output register
Network IN A0	Network OUT A0
Network IN A1	Network OUT A1
Network IN A2	Network OUT A2
Network IN A3	Network OUT A3
Network IN B0	Network OUT B0
Network IN B1	Network OUT B1
Network IN B2	Network OUT B2
Network IN B3	Network OUT B3
Network IN C0	Network OUT C0
Network IN C1	Network OUT C1
Network IN C2	Network OUT C2
Network IN C3	Network OUT C3

The terms "input" and "output" refer to the point of view of the inverter:

- Input data are transmitted by the network master and received by the inverter.
- Output data are transmitted by the inverter and received by the network master.



The exact assignment of the network registers and the number of data words that can be transmitted cyclically varies according to the network/communication protocol. You can find some detailed information in the documentation for the respective communication protocol.

Data mapping

For establishing a simple network connection, the inverter provides predefined control and status words for device profile CiA 402, AC drive profile as well as in LECOM format. By means of data mapping to a network register, each of these words can be transferred as process data via network. Additionally, further mappable data words are provided to individually control the inverter. The mappable data words are described in detail in the following subchapters.



Data mapping cannot be applied to all parameters. The mappable parameters are marked correspondingly in the parameter attribute list.

Configuring the network

Predefined process data words
Device profile CiA 402



8.2.1 Device profile CiA 402

For control via device profile CiA 402, the parameters listed in the following can be mapped to network register.

Details

- The mapping entry for the CiA 402 control word is 0x60400010.
- The mapping entry for the CiA 402 status word is 0x60410010.
- General information about the process of data mapping can be found in the chapter of the same name for the corresponding network.
- For further CiA 402 parameters, see chapter "[Device profile CiA 402](#)". [426](#)

Parameter	Name / value range / [default setting]	Info
0x6040	CiA: Controlword 0 ... [0] ... 65535	Mappable CiA 402 control word with bit assignment according to device profile CiA 402.
	Bit 0 Switch on	1 = switch-on
	Bit 1 Enable voltage	1 = DC bus: Establish readiness for operation
	Bit 2 Quick stop	0 = activate quick stop
	Bit 3 Enable operation	1 = enable operation
	Bit 4 Operation mode specific	Bits are not supported.
	Bit 5 Operation mode specific	
	Bit 6 Operation mode specific	
	Bit 7 Fault reset	0-1 edge = reset error
	Bit 8 Halt (from version 04.00)	1 = stop motor (ramping down to frequency setpoint 0 Hz)
	Bit 9 Operation mode specific	Operating mode dependent
	Bit 14 Release holding brake	1 = releasing holding brake manually ⚠ CAUTION! <ul style="list-style-type: none"> • The manually triggered "Release holding brake" command has a direct impact on the "Release holding brake [115]" trigger. Thus, the holding brake can be manually released if the power section is switched off. • The responsibility for a manual release of the holding brake has the external trigger source for the "Release holding brake" command. ▶ Holding brake control 429
0x6041 (P780.00)	CiA: Statusword (CiA: Statusword) • Read only	Mappable CiA 402 status word with bit assignment according to device profile CiA 402.
	Bit 0 Ready to switch on	1 ≡ drive ready to start
	Bit 1 Switched on	1 ≡ drive switched-on
	Bit 2 Operation enabled	1 ≡ operation enabled
	Bit 3 Fault	1 ≡ fault or trouble active
	Bit 4 Voltage enabled	1 ≡ DC bus ready for operation
	Bit 5 Quick stop	0 ≡ quick stop active
	Bit 6 Switch on disabled	1 ≡ operation inhibited
	Bit 7 Warning	1 ≡ warning active
	Bit 8 RPDOs deactivated	1 ≡ cyclic PDOs have been deactivated.
	Bit 9 Remote	1 ≡ inverter can receive commands via network. <ul style="list-style-type: none"> • Bit is not set in the operating mode 0x6060 (P301.00) = "MS: Velocity mode [-2]".
	Bit 10 Target reached	1 ≡ the actual position is in the window.
	Bit 11 Internal limit active	1 ≡ internal limitation of a setpoint active.
	Bit 14 Holding brake released	1 ≡ holding brake released
Bit 15 Safe torque off (STO) not active	0 ≡ STO active 1 ≡ STO not active	



8.2.2 AC Drive Profile

For control via AC drive profile, the parameters listed in the following can be mapped to network registers.

Details

- The mapping entry for the AC Drive control word is 0x400B0110.
- The mapping entry for the AC Drive status word is 0x400C0110.
- Detailed information on the data mapping can be found in the chapter of the corresponding network.

AC drive control word

The AC Drive control word [0x400B:001 \(P592.01\)](#) will only be processed if the network control in [0x2631:037 \(P400.37\)](#) has been activated and the network is also active as control source.

▶ [Control source change-over](#) [494](#)

- Moreover, some bits in the AC drive control word are ignored if the bit 5 ("Activate network control") is not set. For details see the parameter description for [0x400B:001 \(P592.01\)](#).
- The following logic applies to bit 0 "Run forward (CW)" and bit 1 "Run reverse (CCW)":

Bit 0 "Run forward (CW)"	Bit 1 "Run reverse (CCW)"	Action
0	0	Stopping with stop method set in 0x2838:003 (P203.03) .
0↗1 (edge)	0	Run forward (CW)
0	0↘1 (edge)	Run reverse (CCW)
0↗1 (edge)	0↘1 (edge)	No action / last action is continued to be executed.
1	1	
1	0	
0	1	
1↘0 (edge)	1	Run reverse (CCW)
1	1↘0 (edge)	Run forward (CW)

For further details on the single bits, see the following parameter descriptions:

Parameter	Name / value range / [default setting]	Info
0x400B:001 (P592.01)	Process input data: AC Drive control word (Process data IN: AC control word) 0x0000 ... [0x0000] ... 0xFFFF	Mappable control word with bit assignment in compliance with Ether-Net/IP™ AC drive profile.
	Bit 0 Run forward (CW)	Bits are only evaluated if bit 5 = "1".
	Bit 1 Run reverse (CCW)	For the exact logic, see the above truth table.
	Bit 2 Reset error (0-1 edge)	
	Bit 5 Activate network control	If bit 5 = "1" and 0x2631:037 (P400.37) = "Network control active [114]": All bits of the AC drive control word are evaluated. If bit 5 = "0" or 0x2631:037 (P400.37) = "Not connected [0]": • Bit 0, 1, 12, 13, 14, 15 of the AC drive control word are not evaluated (ignored). • Active control source is the "Flexible I/O configuration". ▶ Control source change-over 494
	Bit 6 Activate network setpoint	0 = the standard setpoint source selected in 0x2860:001 (P201.01) is used. 1 = network setpoint is used.
	Bit 12 Disable inverter	Bits are only evaluated if bit 5 = "1".
	Bit 13 Activate quick stop	
Bit 14 Deactivate PID controlling		
Bit 15 Activate DC braking		

Configuring the network

Predefined process data words
AC Drive Profile



Parameter	Name / value range / [default setting]	Info	
0x400C:001 (P593.01)	Process output data: AC Drive status word (Process data OUT: AC status word) • Read only	Mappable status word with bit assignment in compliance with EtherNet/IP™ AC drive profile.	
	Bit 0	Fault/Trip active	
	Bit 1	Warning active	
	Bit 2	Running forward	
	Bit 3	Running reverse	
	Bit 4	Ready	
	Bit 5	Network control active	
	Bit 6	Network setpoint active	
	Bit 7	At Reference	
	Bit 8	Profile-State bit 0	The drive status is coded as follows: 0: Manufacturer-specific (reserved) 1: Startup (Drive initialisation) 2: Not_Ready (Mains voltage switched off) 3: Ready (Mains voltage switched on) 4: Enabled (Drive has received run command) 5: Stopping (Drive has received stop command and is stopped) 6: Fault_Stop (Drive is stopped due to a fault) 7: Faulted (Faults have occurred)
	Bit 9	Profile-State bit 1	
	Bit 10	Profile-State bit 2	
	Bit 11	Profile-State bit 3	
	Bit 12	Process controller active	
	Bit 13	Torque mode active	
Bit 14	Current limit reached		
Bit 15	DC braking active		
0x6402	Motor type • From version 02.00	AC motor type • Motor Data Object (0x28) - instance attribute 3	
	3		PM synchronous
	6		Wound rotor induction
	7		Squirrel cage induction



8.2.2.1 Customer specific configurations

In addition to the defined AC Drive Profile, the inverter supports customer specific configurations.

Preconditions

- The control unit (CU) of the inverter is provided with EtherNet/IP (from firmware 02.01).
- For commissioning, a programming tool (e. g. »RSLogix™ 5000« for »Allen-Bradley®« control) and current device description files for EtherNet/IP are available:
 - Download »RSLogix™ 5000«
 - Download of EDS files for Lenze devices
- Registered trademarks used or trademarks of the Rockwell Automation® Corporation, USA.
 - »RSLogix™«, »RSLogix™ 5000«
 - »Allen-Bradley®«
 - »CompactLogix™«, »ControlLogix®«, »SoftLogix™«

Supported objects



The terms "Input" and "Output" refer to the view of the Scanner (PLC).

Output Data/assemblies are generated by the Scanner (PLC) and transmitted to the Adapter (Inverter).

InputData/assemblies are generated by the Adapter (inverter) and transmitted to the Scanner (PLC).

For the data exchange, the following assembly object instances are supported according to the "CIP™ Network Library":

Instance ID	Assembly object instance	Info
110	0x6E	For customer specific configurations, these assembly object instances must be used in the scanner (PLC).
111	0x6F	
20	0x14	Assembly output object instances according to AC Drive Profile.
21	0x15	
22	0x16	
23	0x17	
70	0x46	Assembly input object instances according to AC Drive Profile.
71	0x47	
72	0x48	
73	0x49	

All assembly object instances can be accessed with explicit messages of class 3 and the I/O message of class 1.

The Ethernet connection object offers the following common services:

- 0x0E: Get_Attribute_Single (read parameter/assembly data)
- 0x10: Set_Attribute_Single (write parameter/assembly data)

All parameter/assembly data can be changed by "Explicit Messaging".

See also:

- ▶ [EtherNet/IP - acyclic data transfer 301](#) (Explicit Messaging)
- ▶ [EtherNet/IP - cyclic data transfer 298](#) (Implicit Messaging)

Configuring the network

Predefined process data words
AC Drive Profile



Assembly output objects (Output)

Assembly output objects are usually used to enable the inverter (adapter) and define a speed or torque setpoint.

Depending on the data length defined by the PLC (scanner), the memory map of the I/O data may vary in size.

In case of assembly output objects, a 4-byte-header (32-bit-Run/Idle header) is assumed.

When the assemblies are mapped, this header is inserted automatically into the data flow by most of the Allen-Bradley PLC/SFC devices. For this purpose, no adaptations are required.

If your PLC does not support the 4-byte header, complement the output image by a leading 4-byte header. Bit 0 of his header can then be defined in the process image of the PLC:

- State "0": Idle mode
- State "1": Run mode

Assembly input object (Input)

Assembly input objects are ...

- usually used to monitor the status of the inverter (adapter) and request current actual values (e. g. the current speed);
- mapped in the adapter memory from byte 0;
- are transmitted in a "modeless" manner, i. e. a 4-byte header is not transmitted. Thus, the start address in the assembly memory image is the real start of the first assembly data element.



When the assembly input objects are mapped to the control memory, observe the real assembly lengths.

Class Attribute Services

These "Class Attribute Services" are supported:

Service ID	Service name	Data type
1	Get Revision	UNIT
2	Get Max. Instance	
3	Get Number of Instances	
4	Get Number Attributes	
5	Get Optional Attributes	
6	Get Max. ID Number Class Attributes	
7	Get Max. ID Number Instance Attributes	

Instance Attribute Services

These "Instance Attribute Services" are supported:

Service ID	Service name	Data type
1	Get No. of Member in List	UNIT
2	Get Member List	
3	Get/Set Data	
4	Get Size	

I/O configuration with »RSLogix™ 5000« (version 20)

The basic steps for the I/O configuration with the programming software »RSLogix™ 5000« can be found under: [▶ Basic drive control via EtherNet/IP](#)  304



8.2.3 Lenze LECOM profile

For connection to Lenze inverters with a LECOM control word (C135) and LECOM status word (C150), the parameters listed in the following can be mapped to network registers.

Details

- The mapping entry for the LECOM control word is 0x400B0210.
- The mapping entry for the LECOM status word is 0x400C0210.
- General information about the process of data mapping can be found in the chapter of the same name for the corresponding network.

Parameter	Name / value range / [default setting]	Info
0x400B:002 (P592.02)	Process input data: LECOM control word (Process data IN: LECOM ctrl word) 0x0000 ... [0x0000] ... 0xFFFF	Mappable control word with bit assignment in compliance with code C135 of the 8200 Lenze inverter.
	Bit 0 Activate preset (bit 0)	
	Bit 1 Activate preset (bit 1)	
	Bit 2 Reversal rotation direction	
	Bit 3 Activate quick stop	
	Bit 9 Disable inverter	
	Bit 10 Activate fault	
	Bit 11 Reset error (0-1 edge)	
0x400C:002 (P593.02)	Process output data: LECOM status word (Process data OUT: LECOM stat. word) • Read only	Mappable status word with bit assignment in compliance with code C150 of the 8200 Lenze inverter.
	Bit 0 Active parameter set (0 = set 1 or 3; 1 = set 2 or 4)	
	Bit 1 Power section inhibited	
	Bit 2 Current or Torque limit reached	
	Bit 3 Frequency setpoint reached	
	Bit 4 Ramp generator (input = output)	
	Bit 5 Frequency < frequency threshold	
	Bit 6 Actual frequency = 0	
	Bit 7 Inverter disabled	
	Bit 8 Coded status bit 0	
	Bit 9 Coded status bit 1	
	Bit 10 Coded status bit 2	
	Bit 11 Coded status bit 3	
	Bit 12 Overtemperature warning	
	Bit 13 DC-bus overvoltage	
Bit 14 Rotational direction reversed		
Bit 15 Ready for Operation		

Configuring the network

Predefined process data words
Further process data



8.2.4 Further process data

The parameters listed in the following can also be mapped to network registers, in order to transmit control and status information as well as setpoints and actual values as process data.

Details

- The following parameters are always available irrespective of the network option.
- The use of these parameters for the transmission of process data is optional. It is also possible to only use a part of the parameters. For the transmission of the frequency setpoint and actual value, for instance, several parameters with a different resolution can be selected.
- Via the parameters, at the same time the general network activity can be diagnosed.

NetWordIN1 ... NetWordIN4

These four mappable data words are provided to individually control the inverter:

Data word	Parameter	Intended use
NetWordIN1	0x4008:001 (P590.01)	For implementing an individual control word format. ▶ General network settings □ 200
NetWordIN2	0x4008:002 (P590.02)	For controlling the digital outputs via network. ▶ Configuration of digital outputs □ 574
NetWordIN3	0x4008:003 (P590.03)	For controlling the analog outputs via network. ▶ Configuration of analog outputs □ 584
NetWordIN4	0x4008:004 (P590.04)	

NetWordOUT1 and NetWordOUT2

These two mappable data words are provided to output status messages to the network master:

Data word	Parameter	Intended use
NetWordOUT1	0x400A:001 (P591.01)	For implementing an individual status word format. ▶ NetWordOUT1 status word □ 580
NetWordOUT2	0x400A:002 (P591.02)	For the output of messages of the "sequencer" function. ▶ Segment configuration □ 464

The following describes all further process data.

Parameter	Name / value range / [default setting]	Info
0x4008:001 (P590.01)	Process input words: NetWordIN1 (NetWordINx: NetWordIN1) 0x0000 ... [0x0000] ... 0xFFFF	Mappable data word for flexible control of the inverter via network.
	Bit 0 Mapping bit 0	Assignment of the function: 0x400E:001 (P505.01)
	Bit 1 Mapping bit 1	Assignment of the function: 0x400E:002 (P505.02)
	Bit 2 Mapping bit 2	Assignment of the function: 0x400E:003 (P505.03)
	Bit 3 Mapping bit 3	Assignment of the function: 0x400E:004 (P505.04)
	Bit 4 Mapping bit 4	Assignment of the function: 0x400E:005 (P505.05)
	Bit 5 Mapping bit 5	Assignment of the function: 0x400E:006 (P505.06)
	Bit 6 Mapping bit 6	Assignment of the function: 0x400E:007 (P505.07)
	Bit 7 Mapping bit 7	Assignment of the function: 0x400E:008 (P505.08)
	Bit 8 Mapping bit 8	Assignment of the function: 0x400E:009 (P505.09)
	Bit 9 Mapping bit 9	Assignment of the function: 0x400E:010 (P505.10)
	Bit 10 Mapping bit 10	Assignment of the function: 0x400E:011 (P505.11)
	Bit 11 Mapping bit 11	Assignment of the function: 0x400E:012 (P505.12)
	Bit 12 Mapping bit 12	Assignment of the function: 0x400E:013 (P505.13)
	Bit 13 Mapping bit 13	Assignment of the function: 0x400E:014 (P505.14)
	Bit 14 Mapping bit 14	Assignment of the function: 0x400E:015 (P505.15)
Bit 15 Mapping bit 15	Assignment of the function: 0x400E:016 (P505.16)	



Configuring the network

Predefined process data words
Further process data

Parameter	Name / value range / [default setting]	Info	
0x4008:002 (P590.02)	Process input words: NetWordIN2 (NetWordINx: NetWordIN2) 0x0000 ... [0x0000] ... 0xFFFF	Mappable data word for optional control of the digital outputs via network. Assignment of the digital outputs: <ul style="list-style-type: none"> • Relay: 0x2634:001 (P420.01) / selection [34] ... [49] • Digital output 1: 0x2634:002 (P420.02) / selection [34] ... [49] • Digital output 2: 0x2634:003 (P420.03) / selection [34] ... [49] 	
	Bit 0		Mapping bit 0
	Bit 1		Mapping bit 1
	Bit 2		Mapping bit 2
	Bit 3		Mapping bit 3
	Bit 4		Mapping bit 4
	Bit 5		Mapping bit 5
	Bit 6		Mapping bit 6
	Bit 7		Mapping bit 7
	Bit 8		Mapping bit 8
	Bit 9		Mapping bit 9
	Bit 10		Mapping bit 10
	Bit 11		Mapping bit 11
	Bit 12		Mapping bit 12
	Bit 13		Mapping bit 13
	Bit 14		Mapping bit 14
Bit 15	Mapping bit 15		
0x4008:003 (P590.03)	Process input words: NetWordIN3 (NetWordINx: NetWordIN3) 0.0 ... [0.0] ... 100.0 %	Mappable data word for optional control of an analog output via network. Assignment of the analog outputs: <ul style="list-style-type: none"> • Analog output 1: 0x2639:002 (P440.02) = "NetWordIN3 [20]" • Analog output 2: 0x263A:002 (P441.02) = "NetWordIN3 [20]" 	
0x4008:004 (P590.04)	Process input words: NetWordIN4 (NetWordINx: NetWordIN4) 0.0 ... [0.0] ... 100.0 %	Mappable data word for optional control of an analog output via network. Assignment of the analog outputs: <ul style="list-style-type: none"> • Analog output 1: 0x2639:002 (P440.02) = "NetWordIN4 [21]" • Analog output 2: 0x263A:002 (P441.02) = "NetWordIN4 [21]" 	

Configuring the network

Predefined process data words
Further process data



Parameter	Name / value range / [default setting]	Info
0x400A:001 (P591.01)	Process output words: NetWordOUT1 (NetWordOUTx: NetWordOUT1) • Read only	Mappable data word for the output of status messages of the inverter via network.
Bit 0	Mapping bit 0	Mappable data word for the output of status messages of the inverter via network. Assignment of the status message: 0x2634:010 (P420.10)
Bit 1	Mapping bit 1	Mappable data word for the output of status messages of the inverter via network. Assignment of the status message: 0x2634:011 (P420.11)
Bit 2	Mapping bit 2	Mappable data word for the output of status messages of the inverter via network. Assignment of the status message: 0x2634:012 (P420.12)
Bit 3	Mapping bit 3	Mappable data word for the output of status messages of the inverter via network. Assignment of the status message: 0x2634:013 (P420.13)
Bit 4	Mapping bit 4	Mappable data word for the output of status messages of the inverter via network. Assignment of the status message: 0x2634:014 (P420.14)
Bit 5	Mapping bit 5	Mappable data word for the output of status messages of the inverter via network. Assignment of the status message: 0x2634:015 (P420.15)
Bit 6	Mapping bit 6	Mappable data word for the output of status messages of the inverter via network. Assignment of the status message: 0x2634:016 (P420.16)
Bit 7	Mapping bit 7	Mappable data word for the output of status messages of the inverter via network. Assignment of the status message: 0x2634:017 (P420.17)
Bit 8	Mapping bit 8	Mappable data word for the output of status messages of the inverter via network. Assignment of the status message: 0x2634:018 (P420.18)
Bit 9	Mapping bit 9	Mappable data word for the output of status messages of the inverter via network. Assignment of the status message: 0x2634:019 (P420.19)
Bit 10	Mapping bit 10	Mappable data word for the output of status messages of the inverter via network. Assignment of the status message: 0x2634:020 (P420.20)
Bit 11	Mapping bit 11	Mappable data word for the output of status messages of the inverter via network. Assignment of the status message: 0x2634:021 (P420.21)
Bit 12	Mapping bit 12	Mappable data word for the output of status messages of the inverter via network. Assignment of the status message: 0x2634:022 (P420.22)
Bit 13	Mapping bit 13	Mappable data word for the output of status messages of the inverter via network. Assignment of the status message: 0x2634:023 (P420.23)
Bit 14	Mapping bit 14	Mappable data word for the output of status messages of the inverter via network. Assignment of the status message: 0x2634:024 (P420.24)
Bit 15	Mapping bit 15	Mappable data word for the output of status messages of the inverter via network. Assignment of the status message: 0x2634:025 (P420.25)



Configuring the network

Predefined process data words

Further process data

Parameter	Name / value range / [default setting]	Info
0x400A:002 (P591.02)	Process output words: NetWordOUT2 (NetWordOUTx: NetWordOUT2)	Mappable data word for the output of messages of the "Sequencer" function via network. Configuration of the messages: <ul style="list-style-type: none"> • 0x4026:008: NetWordOUT2 value for sequencer segment 1 • 0x4027:008: NetWordOUT2 value for sequencer segment 2 • 0x4028:008: NetWordOUT2 value for sequencer segment 3 • 0x4029:008: NetWordOUT2 value for sequencer segment 4 • 0x402A:008: NetWordOUT2 value for sequencer segment 5 • 0x402B:008: NetWordOUT2 value for sequencer segment 6 • 0x402C:008: NetWordOUT2 value for sequencer segment 7 • 0x402D:008: NetWordOUT2 value for sequencer segment 8 • 0x402E:008: NetWordOUT2 value for final segment
	• Read only	
	Bit 0 Mapping bit 0	
	Bit 1 Mapping bit 1	
	Bit 2 Mapping bit 2	
	Bit 3 Mapping bit 3	
	Bit 4 Mapping bit 4	
	Bit 5 Mapping bit 5	
	Bit 6 Mapping bit 6	
	Bit 7 Mapping bit 7	
	Bit 8 Mapping bit 8	
	Bit 9 Mapping bit 9	
	Bit 10 Mapping bit 10	
	Bit 11 Mapping bit 11	
	Bit 12 Mapping bit 12	
	Bit 13 Mapping bit 13	
Bit 14 Mapping bit 14		
Bit 15 Mapping bit 15		
0x400B:003 (P592.03)	Process input data: Network setpoint frequency (0.1) (Process data IN: Net.freq. 0.1) 0.0 ... [0.0] ... 599.0 Hz	Mappable parameter for specifying the frequency setpoint in [0.1 Hz] via network. <ul style="list-style-type: none"> • The specification is made without sign (irrespective of the rotating direction). • The rotating direction is specified via the control word. • Example: 456 ≙ 45.6 Hz
0x400B:004 (P592.04)	Process input data: Network setpoint speed (Process data IN: Net.setp. speed) 0 ... [0] ... 50000 rpm	Mappable parameter for specifying the setpoint as speed in [rpm] via network. <ul style="list-style-type: none"> • The specification is made without sign (irrespective of the rotating direction). • The rotating direction is specified via the control word. • Example: 456 ≙ 456 rpm
0x400B:005 (P592.05)	Process input data: Network setpoint frequency (0.01) (Process data IN: Net.freq. 0.01) 0.00 ... [0.00] ... 599.00 Hz	Mappable parameter for specifying the frequency setpoint in [0.01 Hz] via network. <ul style="list-style-type: none"> • The specification is made without sign (irrespective of the rotating direction). • The rotating direction is specified via the control word. • Example: 456 ≙ 4.56 Hz
0x400B:009 (P592.09)	Process input data: Torque scaling (Process data IN: Torque scaling) -128 ... [0] ... 127 • From version 02.00	Scaling factor for torque setpoint 0x400B:008 (P592.08) and actual torque value 0x400C:007 (P593.07) via network. <ul style="list-style-type: none"> • With the setting 0, no scaling takes place.
0x400B:012 (P592.12)	Process input data: Network setpoint frequency [0.02Hz] (Process data IN: NetSetfreq0.02Hz) -29950 ... [0] ... 29950 Hz • From version 04.00	Mappable parameter for specifying the frequency setpoint in [0.02 Hz] via network. <ul style="list-style-type: none"> • The specification is made without sign (irrespective of the rotating direction). • The rotating direction is specified via the control word. • Examples: 50 ≙ 1 Hz, 100 ≙ 2 Hz
0x400C:003 (P593.03)	Process output data: Frequency (0.1) (Process data OUT: Frequency (0.1)) • Read only: x.x Hz	Mappable parameter for the output of the actual frequency value in [0.1 Hz] via network. <ul style="list-style-type: none"> • The output is effected without sign (irrespective of the rotating direction). • The rotating direction is specified via the status word. • Example: 456 ≙ 45.6 Hz
0x400C:004 (P593.04)	Process output data: Motor speed (Process data OUT: Motor speed) • Read only: x rpm	Mappable parameter for the output of the actual value as speed in [rpm] via network. <ul style="list-style-type: none"> • The output is effected without sign (irrespective of the rotating direction). • The rotating direction is specified via the status word. • Example: 456 ≙ 456 rpm

Configuring the network

Predefined process data words
Further process data



Parameter	Name / value range / [default setting]	Info
0x400C:005 (P593.05)	Process output data: Drive status (Process data OUT: Drive status)	Mappable status word (Modbus Legacy Register 2003).
	• Read only	
	0 Error (non-resettable) active	
	1 Error active	
	2 Waiting for start	
	3 Identification not executed	
	4 Inverter disabled	
	5 Stop active	
	7 Identification active	
	8 Running	
	9 Acceleration active	
	10 Deceleration active	
	11 Deceleration override active	
	12 DC braking active	
13 Flying start active		
14 Current limit reached		
16 Process controller idle state		
0x400C:006 (P593.06)	Process output data: Frequency (0.01) (Process data OUT: Frequency 0.01)	Mappable parameter for the output of the actual frequency value in [0.01 Hz] via network.
• Read only: x.xx Hz		
0x400C:007 (P593.07)	Process output data: Torque scaled (Process data OUT: Torque scaled)	Mappable parameter for the output of the actual torque value in [Nm / 2 ^{scaling factor}] via network.
	• Read only • From version 02.00	
0x400C:008 (P593.08)	Process output data: Frequency [0.02 Hz] (Process data OUT: Frequency 0.02Hz)	Mappable parameter for the output of the actual frequency value in [0.02 Hz] via network.
	• Read only: Hz • From version 04.00	
		<ul style="list-style-type: none"> • The output is effected without sign (irrespective of the rotating direction). • The rotating direction is specified via the status word. • Examples: 50 ≙ 1 Hz, 100 ≙ 2 Hz



8.3 Parameter access monitoring (PAM)

The parameter access monitoring can be used as basic protection against a control loss of the inverter. Monitoring is triggered if a parameter write access to a certain index does not take place at regular intervals via the established communication connection.

Preconditions

This monitoring only works when the network control is activated.

Except for the keypad, the monitoring can be used for all communication connections, for instance:

- PC/Engineering Tool <--> inverter with USB module
- PC/Engineering Tool <--> inverter with WLAN module
- Controller <--> network <--> inverter with network option

Details

For monitoring purposes, a non-zero value must be written into the "Keep-alive register" [0x2552:002 \(P595.02\)](#) at regular intervals. The first write access with a non-zero value activates monitoring. The intervals between the write accesses must not be higher than the time-out time set in [0x2552:003 \(P595.03\)](#). If no parameter write access takes place within the time-out time, monitoring is triggered: The response selected in [0x2552:005 \(P595.05\)](#) takes place and the action selected in [0x2552:005 \(P595.05\)](#). In addition, the status bit 1 in [0x2552:006 \(P595.06\)](#) is set to "1".

The error status can be left by a normal "error reset". Since monitoring continues to be active and the time-out time is not reset by the error reset, the inverter immediately changes again to the error status. In order to prevent this, you have the following options:

- Restore communication exchange.
- Set the monitoring response in [0x2552:004 \(P595.04\)](#) to "No response [0]" or "Warning [1]".
- Change over to local or flexible control.

Parameter	Name / value range / [default setting]	Info
0x2552:002 (P595.02)	Parameter access monitoring: Keep alive register (PAM monitoring: Keep alive reg.) 0 ... [0] ... 65535 • From version 04.00	Register for cyclic parameter write accesses for monitoring the communication link. • If the setting is non-zero, the monitoring is active. • In order that the monitoring is not tripped, a non-zero value has to be entered into this index at regular intervals. The temporal distances of the write accesses must not be higher than the time-out time set in 0x2552:003 (P595.03) .
0x2552:003 (P595.03)	Parameter access monitoring: Time-out time (PAM monitoring: Time-out time) 0.0 ... [10.0] ... 6553.5 s • From version 04.00	Maximum permitted time between two write accesses to the "keep-alive-register". In case of a time-out • the error response selected in 0x2552:004 (P595.04) is effected, • the action selected in 0x2552:005 (P595.05) is effected, • the status bit 1 in 0x2552:006 (P595.06) is set to "1".
0x2552:004 (P595.04)	Parameter access monitoring: Reaction (PAM monitoring: Reaction) • From version 04.00 • For further possible settings, see parameter 0x2D45:001 (P310.01) . □ 196	Selection of the response to the triggering of the parameter access monitoring. Associated error code: • 33045 0x8115 - Time-out (PAM)
	0 No response	▶ Error types □ 113
0x2552:005 (P595.05)	Parameter access monitoring: Action (PAM monitoring: Action) • From version 04.00	Selection of the action to be executed if the parameter access monitoring is triggered.
	0 No action	
	1 Reserved	

Configuring the network

Parameter access monitoring (PAM)



Parameter	Name / value range / [default setting]	Info
0x2552:006 (P595.06)	Parameter access monitoring: Parameter Access Monitoring-Status (PAM monitoring: PAM status) <ul style="list-style-type: none">• Read only• From version 04.00	Bit coded display of the status of parameter access monitoring.
	Bit 0 Monitoring activated	1 ≙ parameter access monitoring is active.
	Bit 1 Timeout	1 ≙ within the time-out time set in 0x2552:003 (P595.03) , no successful parameter write access to the "keep-alive register" 0x2552:002 (P595.02) was made.

8.4 Acyclic data exchange

The acyclic data exchange is normally used for transmitting parameter data the transmission of which is not time-critical. Such parameter data are for example operating parameters, motor data, and diagnostic information.

Details

- The acyclic data exchange enables access to all parameters of the inverter.
- For all communication protocols except Modbus, the parameter is addressed directly via the index and subindex.
- The parameter attribute list contains a list of all inverter parameters. This list in particular includes some information that is relevant to the reading and writing of parameters via the network.



8.5 CANopen



CANopen® is an internationally approved communication protocol which is designed for commercial and industrial automation applications. High data transfer rates in connection with efficient data formatting provide for the coordination of motion control devices in multi-axis applications.

- Detailed information on CANopen can be found on the web page of the CAN in Automation (CiA) user organisation: <http://www.can-cia.org>
- Information about the dimensioning of a CANopen network can be found in the configuration document for the inverter.
- CANopen® is a registered community trademark of the CAN in Automation e. V user organisation.

Preconditions

- Control unit (CU) of the inverter is provided with CANopen.
- The EDS device description files for CANopen can be found here: <http://www.lenze.com/application-knowledge-base/artikel/200413930/0/>

8.5.1 CANopen introduction

- The implementation of the CANopen communication profile (CiA DS301, version 4.02) enables baud rates of 20 kbps to 1 Mbps.
- For establishing a simple network connection, the inverter provides predefined control and status words for device profile CiA 402, AC-drive profile and in LECOMformat. Additionally, further mappable data words are provided to individually control the inverter.
- The inverter control is preconfigured via a CiA 402-compliant control word.

8.5.2 CANopen node address

Each network node must be provided with a unique node address.

Details

- The node address of the inverter can be optionally set in [0x2301:001 \(P510.01\)](#) or using the DIP switches on the device labelled with "1" ... "64".
- The setting that is active when the inverter is switched on is the effective setting.
- The labelling of the DIP switches corresponds to the values of the individual DIP switches for determining the node address (see the following example).
- The active node address is displayed in [0x2302:001 \(P511.01\)](#).

Example of how the node address is set via the DIP switches

DIP switch	64	32	16	8	4	2	1
Setting	OFF	OFF	ON	OFF	ON	ON	ON
Value	0	0	16	0	4	2	1
Node address	= sum of all values = 16 + 4 + 2 + 1 = 23						

Parameter	Name / value range / [default setting]	Info
0x2301:001 (P510.01)	CANopen settings: Node ID (CANopen sett.: Node ID) 1 ... [1] ... 127	Optionally setting of the node address (instead of setting via DIP switches 1 ... 64). <ul style="list-style-type: none"> • The node address set here only becomes effective if DIP switches 1 ... 64 have been set to OFF before mains switching. • A change in the node address will not be effective until a CAN Reset Node is performed.
0x2302:001 (P511.01)	Active CANopen settings: Active node ID (CANopen diag.: Active node ID) <ul style="list-style-type: none"> • Read only 	Display of the active node address.
0x2303 (P509.00)	CANopen switch position (CANopen switch) <ul style="list-style-type: none"> • Read only 	Display of the DIP switch setting at the last mains power-on.

Configuring the network

CANopen
CANopen baud rate

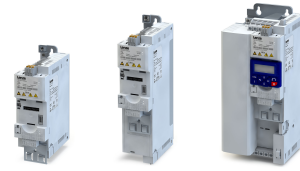

8.5.3 CANopen baud rate

All network nodes must be set to the same baud rate.

Details

- The baud rate can be optionally set in [0x2301:002 \(P510.02\)](#) or using the DIP switches on the device labelled with "a" ... "d" (see the following table).
- The setting that is active when the inverter is switched on is the effective setting.
- The active baud rate is displayed in [0x2302:002 \(P511.02\)](#).

d	c	b	a	Baud rate
OFF	ON	OFF	ON	20 kbps
OFF	OFF	ON	ON	50 kbps
OFF	OFF	ON	OFF	125 kbps
OFF	OFF	OFF	ON	250 kbps
OFF	OFF	OFF	OFF	500 kbps
OFF	ON	OFF	OFF	1 Mbps

When a combination is set that is not in the list, the baud rate is set to 500 kbps.

Parameter	Name / value range / [default setting]	Info
0x2301:002 (P510.02)	CANopen settings: Baud rate (CANopen sett.: Baud rate)	Optionally, setting of the baud rate (instead of setting via DIP switches a ... d). • The parameterised baud rate is only effective if DIP switches a ... d and 1 ... 64 were set to before mains switching. • A change in the baud rate will not be effective until a CAN reset node is performed.
	0 Automatic (from version 03.00)	
	1 20 kbps	
	2 50 kbps	
	3 125 kbps	
	4 250 kbps	
	5 500 kbps	
	6 800 kbps	
7 1 Mbps		
0x2302:002 (P511.02)	Active CANopen settings: Active baud rate (CANopen diag.: Active baud rate) • Read only	Display of the active baud rate.
	0 Automatic (from version 03.00)	
	1 20 kbps	
	2 50 kbps	
	3 125 kbps	
	4 250 kbps	
	5 500 kbps	
	6 800 kbps	
7 1 Mbps		



8.5.4 CANopen initialisation

If the initialisation of the CANopen network and the associated status change from "Pre-Operational" to "Operational" is not effected by a higher-level host system, the inverter can instead be defined as a "mini" master to execute this task.

Details

The inverter is configured as mini master in [0x2301:003 \(P510.03\)](#).

- In the default setting, the inverter is configured as slave and waits for the NMT telegram "Start Remote Node" from the master/host system after being switched on.
- Configured as mini master, the inverter changes to the "Operational" state after being switched on and sets all nodes connected to the CAN bus (broadcast telegram) to the "Operational" communication state using the "Start Remote Node" NMT telegram after the deceleration time set in [0x2301:004 \(P510.04\)](#) has elapsed. Only this communication status enables data exchange via the process data objects.



The change of the master/slave operation only becomes effective by renewed mains switching of the inverter or by sending the NMT telegram "Reset Node" or "Reset Communication" to the inverter. Alternatively, the CAN communication can be restarted via [0x2300 \(P508.00\)](#). [▶ Resetting the CANopen interface](#)
[📖 251](#)

Parameter	Name / value range / [default setting]	Info
0x2301:003 (P510.03)	CANopen settings: Slave/Master (CANopen sett.: Slave/Master)	1 = after mains switching, inverter starts as mini-master.
	0 Slave	
	1 Mini-master	
0x2301:004 (P510.04)	CANopen settings: Start remote delay (CANopen sett.: Start rem. delay) 0 ... [3000] ... 65535 ms	If the inverter has been defined as mini-master, a delay time can be set here, which has to elapse after mains switching before the inverter deposits the "Start Remote Node" NMT telegram on the CAN bus.

Configuring the network

CANopen
CANopen diagnostics



8.5.5 CANopen diagnostics

For the purpose of diagnostics, the inverter provides several status words via which the CAN bus status, the CAN bus controller status, and the status of different time monitoring functions can be queried.

Parameter	Name / value range / [default setting]	Info
0x2307 (P515.00)	CANopen time-out status (Time-out status) • Read only	Bit-coded status display of the CAN time monitoring functions.
	Bit 0 RPDO1-Timeout	1 ≡ RPDO1 was not received within the monitoring time or not with the sync configured. • Status is reset automatically after the RPDO has been received again. • Setting of monitoring time for RPDO1 in 0x1400:005 (P540.05) .
	Bit 1 RPDO2-Timeout	1 ≡ RPDO2 was not received within the monitoring time or not with the sync configured. • Status is reset automatically after the RPDO has been received again. • Setting of monitoring time for RPDO2 in 0x1401:005 (P541.05) .
	Bit 2 RPDO3-Timeout	1 ≡ RPDO3 was not received within the monitoring time or not with the sync configured. • Status is reset automatically after the RPDO has been received again. • Setting of monitoring time for RPDO3 in 0x1402:005 (P542.05) .
	Bit 8 Heartbeat-Timeout Consumer 1	1 ≡ within the "Heartbeat Consumer Time", no heartbeat telegram was received from node 1 to be monitored. • Status can only be reset by mains switching or error reset. • "Heartbeat Consumer Time" setting in 0x1016:001 (P520.01) .
	Bit 9 Heartbeat-Timeout Consumer 2	1 ≡ within the "Heartbeat Consumer Time", no heartbeat telegram was received from node 2 to be monitored. • Status can only be reset by mains switching or error reset. • "Heartbeat Consumer Time" setting in 0x1016:002 (P520.02) .
	Bit 10 Heartbeat-Timeout Consumer 3	1 ≡ within the "Heartbeat Consumer Time", no heartbeat telegram was received from node 3 to be monitored. • Status can only be reset by mains switching or error reset. • "Heartbeat Consumer Time" setting in 0x1016:003 (P520.03) .
	Bit 11 Heartbeat-Timeout Consumer 4	1 ≡ within the "Heartbeat Consumer Time", no heartbeat telegram was received from node 4 to be monitored. • Status can only be reset by mains switching or error reset. • "Heartbeat Consumer Time" setting in 0x1016:004 (P520.04) .
0x2308 (P516.00)	CANopen status (CANopen status) • Read only	Display of the current fieldbus state
	0 Initialisation	Fieldbus initialisation active. • The initialisation is started automatically at mains connection. During this phase, the inverter is not involved in the data exchange process on the CAN bus. • All CAN-relevant parameters are initialised with the saved settings. • When the initialisation process has been completed, the inverter automatically adopts the "Pre-Operational" state.
	1 Reset node	"Reset Node" NMT command active. • All parameters are initialised with the saved settings (not only the CAN-relevant parameters).
	2 Reset communication	"Reset Communication" NMT command active. • Initialisation of all CAN-relevant parameters with the values stored.
	4 Stopped	Only network management telegrams can be received.
	5 Operational	Parameter data and process data can be received. If defined, process data is sent as well.
	127 Pre-Operational	Parameter data can be received, process data are ignored.

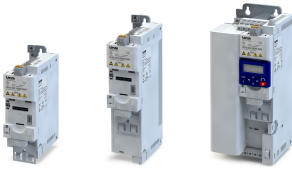

Parameter	Name / value range / [default setting]	Info
0x2309 (P517.00)	CANopen controller status (CAN contr.status) • Read only	Status display of the internal CANopen controller.
	1 Error active	The inverter is a fully-fledged communication node at the CANopen network. It is able to transmit and receive data and to report faults.
	2 Error passive	The inverter can only passively indicate faulty reception via the ACK field.
	3 Bus off	The inverter is electrically separated from the CANopen network. In order to exit this state, the CANopen interface must be reset. An automatic restart is implemented.

8.5.6 CANopen emergency telegram

If the error status changes when an internal device error occurs or is remedied, an emergency telegram is sent to the NMT master once.

Details

- The identifier for the emergency telegram is fixedly defined and is shown in [0x1014](#).
- In [0x1015](#), a blocking time can be set, in order to limit the bus load in the case of emergency telegrams following quickly in succession.

Parameter	Name / value range / [default setting]	Info
0x1014	COB-ID EMCY • Read only	Display of the identifier for emergency telegrams.
0x1015	Inhibit time EMCY 0.0 ... [0.0] ... 6553.5 ms	Blocking time which can be set in order to limit the bus load in the case of emergency telegrams following quickly in succession.

8.5.7 CANopen heartbeat protocol

The heartbeat protocol can be used for node monitoring purposes within a CAN network.

Details

Basic procedure:

1. A heartbeat producer cyclically sends a heartbeat telegram to one or several receivers (consumers).
2. The consumer(s) monitor(s) the heartbeat telegram for arrival on a regular basis.

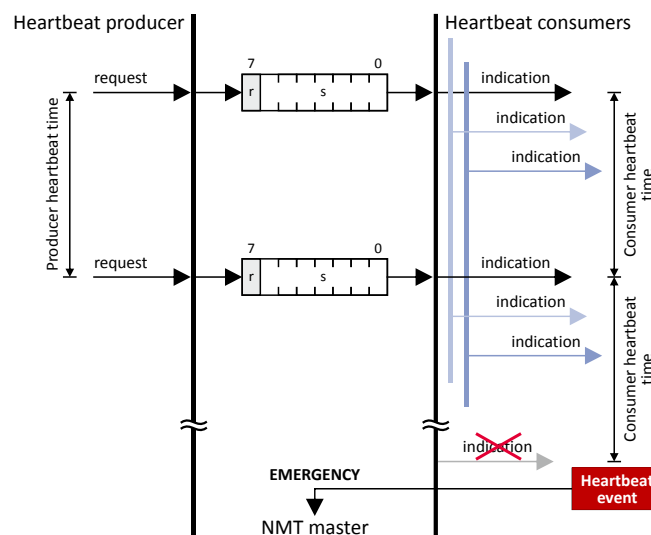

The inverter can be configured as producer or as consumer to monitor up to four other nodes.

Parameter	Name / value range / [default setting]	Info
0x1016:000 (P520.00)	Consumer heartbeat time: Highest sub-index supported (Cons. heartbeat: Highest subindex) • Read only	Highest subindex, permanently set to 4. Corresponds at the same time to the maximum possible number of nodes to be monitored.

Configuring the network

CANopen

CANopen heartbeat protocol

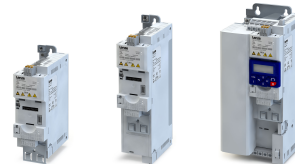

Parameter	Name / value range / [default setting]	Info
0x1016:001 (P520.01)	Consumer heartbeat time: Consumer heartbeat time 1 (Cons. heartbeat: Cons. heartbeat1) 0x00000000 ... [0x00000000] ... 0x00FFFFFF	Node ID and heartbeat time of node 1 which is to be monitored. • Format: 0x00nnhhhh (nn = node ID, hhhh = heartbeat time in [ms])
0x1016:002 (P520.02)	Consumer heartbeat time: Consumer heartbeat time 2 (Cons. heartbeat: Cons. heartbeat2) 0x00000000 ... [0x00000000] ... 0x00FFFFFF	Node ID and heartbeat time of node 2 which is to be monitored. • Format: 0x00nnhhhh (nn = node ID, hhhh = heartbeat time in [ms])
0x1016:003 (P520.03)	Consumer heartbeat time: Consumer heartbeat time 3 (Cons. heartbeat: Cons. heartbeat3) 0x00000000 ... [0x00000000] ... 0x00FFFFFF	Node ID and heartbeat time of node 3 which is to be monitored. • Format: 0x00nnhhhh (nn = node ID, hhhh = heartbeat time in [ms])
0x1016:004 (P520.04)	Consumer heartbeat time: Consumer heartbeat time 4 (Cons. heartbeat: Cons. heartbeat4) 0x00000000 ... [0x00000000] ... 0x00FFFFFF	Node ID and heartbeat time of node 4 which is to be monitored. • Format: 0x00nnhhhh (nn = node ID, hhhh = heartbeat time in [ms])
0x1017 (P522.00)	Producer heartbeat time (Prod. heartbeat) 0 ... [0] ... 65535 ms	Time interval for the transmission of the heartbeat telegram to the consumer(s). • The heartbeat telegram is sent automatically as soon as a time > 0 ms is set. • The set time is internally rounded up to the next multiple of 10 ms.



8.5.8 CANopen process data objects

Process data objects (PDOs) are used for the cyclic transmission of (process) data via CANopen. PDOs only contain data and an identifier. They do not contain any information about the sender or receiver and are therefore very efficient.

Details

- Process data objects which the inverter receives via the network are referred to as "Receive PDOs" (RPDOs).
- Process data objects which the inverter sends via the network are referred to as "Transmit PDOs" (TPDOs).
- The maximum length of a PDO is 8 bytes (4 data words).
- Each PDO requires a unique identifier ("COB-ID") for the purpose of identification within the network.
- Communication parameters such as the transmission type and cycle time for each PDO can be set freely and independently of the settings of other PDOs

Transmission type

Process data objects can be transmitted in an event-controlled or time-controlled manner. The below table shows that it is possible to combine the different methods by means of logic operations (AND, OR):

- Event-controlled: The PDO is sent if a special device-internal event has occurred, for instance, if the data contents of the TPDO have changed or if a transmission cycle time has elapsed.
- Synchronous transmission: Transmission of a TPDOs or reception of an RPDO is effected after the inverter has received a sync telegram (COB-ID 0x80).
- Cyclic transmission: The cyclic transmission of PDOs is effected when the transmission cycle time has elapsed.
- Polled via RTR: Transmission of a TPDO is carried out on request by another device via data request frame (RTR remote transmit request). For this, the data requester (e.g. master) sends the data request frame with the COB-ID of the TPDO that is to be requested to transmit. The receiver recognises the RTR and carries out the transmission.

Transmission type	PDO transmission			Logic combination of different transmission types
	cyclic	synchronous	event-controlled	
0		●	●	AND
1 ... 240		●		-
254, 255	●		●	OR

Transmission type	Description
0	Synchronous and acyclic <ul style="list-style-type: none"> • The PDO is transmitted on an event-controlled basis with every sync (e.g. when a bit change occurs in the PDO).
1 ... 240	Synchronous and cyclic (sync-controlled with a response) <ul style="list-style-type: none"> • Selection n = 1: The PDO is transmitted with every sync. • Selection 1 < n ≤ 240: The PDO is transmitted with every n-th sync.
241 ... 251	Reserved
252	Synchronous - RTR only
253	Asynchronous - RTR only
254, 255	Asynchronous - manufacturer-specific / device profile-specific <ul style="list-style-type: none"> • If one of these values is entered, the PDO is transferred in an event-controlled or cyclic manner. (The values "254" and "255" are equivalent). • For a cyclic transmission, a cycle time must be entered for the respective PDO. In this case, cyclic transmission takes place in addition to event-controlled transmission.

Configuring the network

CANopen
CANopen process data objects



Synchronisation of PDOs via sync telegram

During cyclic transmission, one or more PDOs are transmitted/received in fixed time intervals. An additional specific telegram, the so-called sync telegram, is used for synchronising cyclic process data.

- The sync telegram is the trigger point for the transmission of process data from the slaves to the master and for the acceptance of process data from the master in the slaves.
- For sync-controlled process data processing, the sync telegram must be generated accordingly.
- The response to a sync telegram is determined by the transmission type selected.

Generating the sync telegram:

- **0x1005** can be used to activate the generation of sync telegrams and to write the identifier value.
- Sync telegrams are created when bit 30 (see below) is set to "1".
- The interval between sync telegrams is to be set in **0x1006**.

Writing identifiers:

- To receive sync telegrams, the value 0x80 must be entered in the 11-bit identifier in the default setting (and in compliance with the CANopen specification). This means that all inverters are set to the same sync telegram by default.
- If sync telegrams are only to be received by specific nodes, their identifiers can be entered with a value of up to and including 0x07FF.
- The identifier can only be changed if the inverter does not send any sync telegrams (**0x1005**, Bit 30 = "0").

Data telegram assignment

8th byte (data 4)		7th byte (data 3)	6th byte (data 2)	5th byte (data 1)
Bit 31	Bit 30	Bit 29 ... bit 11		Bit 10 ... bit 0
x	0/1	Extended identifier*		11-bit identifier

* The extended identifier is not supported. Bit 11 ... bit 29 must be set to "0".

Parameter	Name / value range / [default setting]	Info
0x1005	COB-ID SYNC 0x00000000 ... [0x00000080] ... 0xFFFFFFFF	Identifier for sync telegram. How to change the identifier: 1. Deactivate Sync: Set bit 30 to "0". 2. Change identifier. 3. Activate Sync: Set bit 30 to "1".
0x1006	Communication cyclic period 0 ... [0] ... 65535000 us	Cycle time for sync telegrams. • With the setting "0", no sync telegrams are generated. • The set time is internally rounded up to the next multiple of 10 ms. The shortest possible cycle time thus is 10 ms.
0x1400:000	RPDO1 communication parameter: Highest sub-index supported • Read only	
0x1400:001 (P540.01)	RPDO1 communication parameter: COB-ID (RPDO1 config.: COB-ID) 0x00000000 ... [0x00000200] ... 0xFFFFFFFF	RPDO1: identifier How to change the identifier: 1. Set PDO to "invalid": Set bit 31 to "1". 2. Change identifier and reset PDO to "valid" (bit 31 = "0").
	Bit 0	COB-ID bit 0
	Bit 1	COB-ID bit 1
	Bit 2	COB-ID bit 2
	Bit 3	COB-ID bit 3
	Bit 4	COB-ID bit 4
	Bit 5	COB-ID bit 5
	Bit 6	COB-ID bit 6
	Bit 7	COB-ID bit 7
	Bit 8	COB-ID bit 8
	Bit 9	COB-ID bit 9
	Bit 10	COB-ID bit 10
	Bit 31	PDO invalid



Configuring the network

CANopen
CANopen process data objects

Parameter	Name / value range / [default setting]	Info
0x1400:002 (P540.02)	RPDO1 communication parameter: Transmission type (RPDO1 config.: Transm. type) 0 ... [255] ... 255	RPDO1: transmission type in compliance with DS301 V4.02
0x1400:005 (P540.05)	RPDO1 communication parameter: Event timer (RPDO1 config.: Event timer) 0 ... [100] ... 65535 ms	RPDO1: time-out for the monitoring of data reception.
0x1401:001 (P541.01)	RPDO2 communication parameter: COB-ID (RPDO2 config.: COB-ID) 0x00000000 ... [0x80000300] ... 0xFFFFFFFF	RPDO2: identifier How to change the identifier: 1. Set PDO to "invalid": Set bit 31 to "1". 2. Change identifier and reset PDO to "valid" (bit 31 = "0").
	Bit 0 COB-ID bit 0	
	Bit 1 COB-ID bit 1	
	Bit 2 COB-ID bit 2	
	Bit 3 COB-ID bit 3	
	Bit 4 COB-ID bit 4	
	Bit 5 COB-ID bit 5	
	Bit 6 COB-ID bit 6	
	Bit 7 COB-ID bit 7	
	Bit 8 COB-ID bit 8	
	Bit 9 COB-ID bit 9	
	Bit 10 COB-ID bit 10	
	Bit 31 PDO invalid	
0x1401:002 (P541.02)	RPDO2 communication parameter: Transmission type (RPDO2 config.: Transm. type) 0 ... [255] ... 255	RPDO2: transmission type in compliance with DS301 V4.02
0x1401:005 (P541.05)	RPDO2 communication parameter: Event timer (RPDO2 config.: Event timer) 0 ... [100] ... 65535 ms	RPDO2: time-out for the monitoring of data reception.
0x1402:001 (P542.01)	RPDO3 communication parameter: COB-ID (RPDO3 config.: COB-ID) 0x00000000 ... [0x80000400] ... 0xFFFFFFFF	RPDO3: identifier How to change the identifier: 1. Set PDO to "invalid": Set bit 31 to "1". 2. Change identifier and reset PDO to "valid" (bit 31 = "0").
	Bit 0 COB-ID bit 0	
	Bit 1 COB-ID bit 1	
	Bit 2 COB-ID bit 2	
	Bit 3 COB-ID bit 3	
	Bit 4 COB-ID bit 4	
	Bit 5 COB-ID bit 5	
	Bit 6 COB-ID bit 6	
	Bit 7 COB-ID bit 7	
	Bit 8 COB-ID bit 8	
	Bit 9 COB-ID bit 9	
	Bit 10 COB-ID bit 10	
	Bit 31 PDO invalid	
0x1402:002 (P542.02)	RPDO3 communication parameter: Transmission type (RPDO3 config.: Transm. type) 0 ... [255] ... 255	RPDO3: transmission type in compliance with DS301 V4.02
0x1402:005 (P542.05)	RPDO3 communication parameter: Event timer (RPDO3 config.: Event timer) 0 ... [100] ... 65535 ms	RPDO3: time-out for the monitoring of data reception.
0x1800:000	TPDO1 communication parameter: Highest sub-index supported • Read only	The value "5" is permanently set.

Configuring the network

CANopen

CANopen process data objects

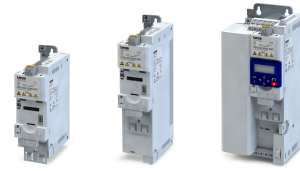

Parameter	Name / value range / [default setting]	Info
0x1800:001 (P550.01)	TPDO1 communication parameter: COB-ID (TPDO1 config.: COB-ID) 0x00000001 ... [0x40000180] ... 0xFFFFFFFF	TPDO1: identifier How to change the identifier: 1. Set PDO to "invalid": Set bit 31 to "1". 2. Change identifier and reset PDO to "valid" (bit 31 = "0").
	Bit 0 COB-ID bit 0	
	Bit 1 COB-ID bit 1	
	Bit 2 COB-ID bit 2	
	Bit 3 COB-ID bit 3	
	Bit 4 COB-ID bit 4	
	Bit 5 COB-ID bit 5	
	Bit 6 COB-ID bit 6	
	Bit 7 COB-ID bit 7	
	Bit 8 COB-ID bit 8	
	Bit 9 COB-ID bit 9	
	Bit 10 COB-ID bit 10	
	Bit 30 RTR not allowed	
Bit 31 PDO invalid		
0x1800:002 (P550.02)	TPDO1 communication parameter: Transmission type (TPDO1 config.: Transm. type) 0 ... [255] ... 255	TPDO1: transmission type in compliance with DS301 V4.02
0x1800:003 (P550.03)	TPDO1 communication parameter: Inhibit time (TPDO1 config.: Inhibit time) 0.0 ... [0.0] ... 6553.5 ms	TPDO1: minimum time between the transmission of two identical PDOs (see DS301 V4.02).
0x1800:005 (P550.05)	TPDO1 communication parameter: Event timer (TPDO1 config.: Event timer) 0 ... [20] ... 65535 ms	TPDO1: Cycle time for PDO transmission with transmission type "254" or "255". • The set time is internally rounded up to the next multiple of 10 ms.
0x1801:000	TPDO2 communication parameter: Highest sub-index supported • Read only	The value "5" is permanently set.
0x1801:001 (P551.01)	TPDO2 communication parameter: COB-ID (TPDO2 config.: COB-ID) 0x00000001 ... [0xC0000280] ... 0xFFFFFFFF	TPDO2: identifier How to change the identifier: 1. Set PDO to "invalid": Set bit 31 to "1". 2. Change identifier and reset PDO to "valid" (bit 31 = "0").
	Bit 0 COB-ID bit 0	
	Bit 1 COB-ID bit 1	
	Bit 2 COB-ID bit 2	
	Bit 3 COB-ID bit 3	
	Bit 4 COB-ID bit 4	
	Bit 5 COB-ID bit 5	
	Bit 6 COB-ID bit 6	
	Bit 7 COB-ID bit 7	
	Bit 8 COB-ID bit 8	
	Bit 9 COB-ID bit 9	
	Bit 10 COB-ID bit 10	
	Bit 30 RTR not allowed	
Bit 31 PDO invalid		
0x1801:002 (P551.02)	TPDO2 communication parameter: Transmission type (TPDO2 config.: Transm. type) 0 ... [255] ... 255	TPDO2: transmission type in compliance with DS301 V4.02
0x1801:003 (P551.03)	TPDO2 communication parameter: Inhibit time (TPDO2 config.: Inhibit time) 0.0 ... [0.0] ... 6553.5 ms	TPDO2: minimum time between the transmission of two identical PDOs (see DS301 V4.02).
0x1801:005 (P551.05)	TPDO2 communication parameter: Event timer (TPDO2 config.: Event timer) 0 ... [0] ... 65535 ms	TPDO2: Cycle time for PDO transmission with transmission type "254" or "255". • The set time is internally rounded up to the next multiple of 10 ms.
0x1802:000	TPDO3 communication parameter: Highest sub-index supported • Read only	The value "5" is permanently set.



Configuring the network

CANopen
CANopen process data objects

Parameter	Name / value range / [default setting]	Info
0x1802:001 (P552.01)	TPDO3 communication parameter: COB-ID (TPDO3 config.: COB-ID) 0x00000001 ... [0xC0000380] ... 0xFFFFFFFF	TPDO3: identifier How to change the identifier: 1. Set PDO to "invalid": Set bit 31 to "1". 2. Change identifier and reset PDO to "valid" (bit 31 = "0").
	Bit 0 COB-ID bit 0	
	Bit 1 COB-ID bit 1	
	Bit 2 COB-ID bit 2	
	Bit 3 COB-ID bit 3	
	Bit 4 COB-ID bit 4	
	Bit 5 COB-ID bit 5	
	Bit 6 COB-ID bit 6	
	Bit 7 COB-ID bit 7	
	Bit 8 COB-ID bit 8	
	Bit 9 COB-ID bit 9	
	Bit 10 COB-ID bit 10	
Bit 30 RTR not allowed		
Bit 31 PDO invalid		
0x1802:002 (P552.02)	TPDO3 communication parameter: Transmission type (TPDO3 config.: Transm. type) 0 ... [255] ... 255	TPDO3: transmission type in compliance with DS301 V4.02
0x1802:003 (P552.03)	TPDO3 communication parameter: Inhibit time (TPDO3 config.: Inhibit time) 0.0 ... [0.0] ... 6553.5 ms	TPDO3: minimum time between the transmission of two identical PDOs (see DS301 V4.02).
0x1802:005 (P552.05)	TPDO3 communication parameter: Event timer (TPDO3 config.: Event timer) 0 ... [0] ... 65535 ms	TPDO3: Cycle time for PDO transmission with transmission type "254" or "255". <ul style="list-style-type: none"> The set time is internally rounded up to the next multiple of 10 ms.
0x2301:006 (P510.06)	CANopen settings: COB-ID Configuration (CANopen sett.: COB-ID Config) <ul style="list-style-type: none"> From version 03.00 	Selection of the process for assigning the identifiers. Irrespective of this selection, these are the following bits of the identifiers: <ul style="list-style-type: none"> Bit 30: "RTR not allowed" (only in case of TPDO) Bit 31: "PDO invalid"
	0 Base + node-ID	Identifier = set (basic) identifiers + set node address
	1 Freely configurable	Identifier = set identifiers

Configuring the network

CANopen
CANopen data mapping



8.5.9 CANopen data mapping

Data mapping serves to define which process data are transmitted cyclically via the process data channels.

Details

Data mapping (in the case of CANopen also referred to as "PDO mapping") is preconfigured for control of the inverter via the device profile CiA 402:

- RPDO1 = CiA 402 control word **0x6040** and Target velocity **0x6042 (P781.00)**.
- TPDO1 = CiA 402 status word **0x6041 (P780.00)** and Velocity actual value **0x6044 (P783.00)**.

Variable PDO mapping

For individual drive solutions, the inverter supports "variable PDO mapping", providing 8 mapping entries in each case to assign 8-bit, 16-bit, and 32-bit parameters to a PDO in an optional order. The total length of the parameters mapped, however, must not exceed 8 bytes.



The process of PDO mapping cannot be applied to all parameters. The mappable parameters are marked correspondingly in the parameter attribute list.

The process of variable PDO mapping only allows the following procedure:

1. Set PDO to "invalid": set bit 31 in the corresponding identifier (0x1400:1 ... 0x1402:1 or 0x1800:1 ... 0x1802:1) to "1".
2. Set PDO mapping to "invalid": Set subindex 0 in the mapping parameter (0x1600 ... 0x1602 or 0x1A00 ... 0x1A02) to "0".
3. Set desired PDO mapping via the corresponding mapping entries.
format: 0xiiiiissll (iiii = hexadecimal index, ss = hexadecimal subindex, ll = hexadecimal data length)
4. Set subindex 0 in the mapping parameter (0x1600 ... 0x1602 or 0x1A00 ... 0x1A02) to a valid value (number of parameters mapped).
5. Reset PDO to "valid": set bit 31 in the corresponding identifier (0x1400:1 ... 0x1402:1 or 0x1800:1 ... 0x1802:1) to "0".

Parameter	Name / value range / [default setting]	Info
0x1600:000	RPDO1 mapping parameter: Number of mapped application objects in PDO 0 ... [2] ... 8	Number of objects mapped in RPDO1.
0x1600:001	RPDO1 mapping parameter: Application object 1 0x00000000 ... [0x60400010] ... 0xFFFFFFFF	Mapping entry 1 for RPDO1.
0x1600:002	RPDO1 mapping parameter: Application object 2 0x00000000 ... [0x60420010] ... 0xFFFFFFFF	Mapping entry 2 for RPDO1.
0x1600:003	RPDO1 mapping parameter: Application object 3 0x00000000 ... [0x00000000] ... 0xFFFFFFFF	Mapping entry 3 for RPDO1.
0x1600:004	RPDO1 mapping parameter: Application object 4 0x00000000 ... [0x00000000] ... 0xFFFFFFFF	Mapping entry 4 for RPDO1.
0x1600:005	RPDO1 mapping parameter: Application object 5 0x00000000 ... [0x00000000] ... 0xFFFFFFFF	Mapping entry 5 for RPDO1.
0x1600:006	RPDO1 mapping parameter: Application object 6 0x00000000 ... [0x00000000] ... 0xFFFFFFFF	Mapping entry 6 for RPDO1.
0x1600:007	RPDO1 mapping parameter: Application object 7 0x00000000 ... [0x00000000] ... 0xFFFFFFFF	Mapping entry 7 for RPDO1.
0x1600:008	RPDO1 mapping parameter: Application object 8 0x00000000 ... [0x00000000] ... 0xFFFFFFFF	Mapping entry 8 for RPDO1.
0x1601:000	RPDO2 mapping parameter: Number of mapped application objects in PDO 0 ... [0] ... 8	Number of objects mapped in RPDO2.
0x1601:001	RPDO2 mapping parameter: Application object 1 0x00000000 ... [0x00000000] ... 0xFFFFFFFF	Mapping entry 1 for RPDO2.
0x1601:002	RPDO2 mapping parameter: Application object 2 0x00000000 ... [0x00000000] ... 0xFFFFFFFF	Mapping entry 2 for RPDO2.



Configuring the network

CANopen
CANopen data mapping

Parameter	Name / value range / [default setting]	Info
0x1601:003	RPDO2 mapping parameter: Application object 3 0x00000000 ... [0x00000000] ... 0xFFFFFFFF	Mapping entry 3 for RPDO2.
0x1601:004	RPDO2 mapping parameter: Application object 4 0x00000000 ... [0x00000000] ... 0xFFFFFFFF	Mapping entry 4 for RPDO2.
0x1601:005	RPDO2 mapping parameter: Application object 5 0x00000000 ... [0x00000000] ... 0xFFFFFFFF	Mapping entry 5 for RPDO2.
0x1601:006	RPDO2 mapping parameter: Application object 6 0x00000000 ... [0x00000000] ... 0xFFFFFFFF	Mapping entry 6 for RPDO2.
0x1601:007	RPDO2 mapping parameter: Application object 7 0x00000000 ... [0x00000000] ... 0xFFFFFFFF	Mapping entry 7 for RPDO2.
0x1601:008	RPDO2 mapping parameter: Application object 8 0x00000000 ... [0x00000000] ... 0xFFFFFFFF	Mapping entry 8 for RPDO2.
0x1602:000	RPDO3 mapping parameter: Number of mapped application objects in PDO 0 ... [0] ... 8	Number of objects mapped in RPDO3.
0x1602:001	RPDO3 mapping parameter: Application object 1 0x00000000 ... [0x00000000] ... 0xFFFFFFFF	Mapping entry 1 for RPDO3.
0x1602:002	RPDO3 mapping parameter: Application object 2 0x00000000 ... [0x00000000] ... 0xFFFFFFFF	Mapping entry 2 for RPDO3.
0x1602:003	RPDO3 mapping parameter: Application object 3 0x00000000 ... [0x00000000] ... 0xFFFFFFFF	Mapping entry 3 for RPDO3.
0x1602:004	RPDO3 mapping parameter: Application object 4 0x00000000 ... [0x00000000] ... 0xFFFFFFFF	Mapping entry 4 for RPDO3.
0x1602:005	RPDO3 mapping parameter: Application object 5 0x00000000 ... [0x00000000] ... 0xFFFFFFFF	Mapping entry 5 for RPDO3.
0x1602:006	RPDO3 mapping parameter: Application object 6 0x00000000 ... [0x00000000] ... 0xFFFFFFFF	Mapping entry 6 for RPDO3.
0x1602:007	RPDO3 mapping parameter: Application object 7 0x00000000 ... [0x00000000] ... 0xFFFFFFFF	Mapping entry 7 for RPDO3.
0x1602:008	RPDO3 mapping parameter: Application object 8 0x00000000 ... [0x00000000] ... 0xFFFFFFFF	Mapping entry 8 for RPDO3.
0x1A00:000	TPDO1 mapping parameter: Number of mapped application objects in TPDO 0 ... [2] ... 8	Number of objects mapped in TPDO1.
0x1A00:001	TPDO1 mapping parameter: Application object 1 0x00000000 ... [0x60410010] ... 0xFFFFFFFF	Mapping entry 1 for TPDO1.
0x1A00:002	TPDO1 mapping parameter: Application object 2 0x00000000 ... [0x60440010] ... 0xFFFFFFFF	Mapping entry 2 for TPDO1.
0x1A00:003	TPDO1 mapping parameter: Application object 3 0x00000000 ... [0x00000000] ... 0xFFFFFFFF	Mapping entry 3 for TPDO1.
0x1A00:004	TPDO1 mapping parameter: Application object 4 0x00000000 ... [0x00000000] ... 0xFFFFFFFF	Mapping entry 4 for TPDO1.
0x1A00:005	TPDO1 mapping parameter: Application object 5 0x00000000 ... [0x00000000] ... 0xFFFFFFFF	Mapping entry 5 for TPDO1.
0x1A00:006	TPDO1 mapping parameter: Application object 6 0x00000000 ... [0x00000000] ... 0xFFFFFFFF	Mapping entry 6 for TPDO1.
0x1A00:007	TPDO1 mapping parameter: Application object 7 0x00000000 ... [0x00000000] ... 0xFFFFFFFF	Mapping entry 7 for TPDO1.
0x1A00:008	TPDO1 mapping parameter: Application object 8 0x00000000 ... [0x00000000] ... 0xFFFFFFFF	Mapping entry 8 for TPDO1.
0x1A01:000	TPDO2 mapping parameter: Number of mapped application objects in TPDO 0 ... [0] ... 8	Number of objects mapped in TPDO2.
0x1A01:001	TPDO2 mapping parameter: Application object 1 0x00000000 ... [0x00000000] ... 0xFFFFFFFF	Mapping entry 1 for TPDO2.
0x1A01:002	TPDO2 mapping parameter: Application object 2 0x00000000 ... [0x00000000] ... 0xFFFFFFFF	Mapping entry 2 for TPDO2.
0x1A01:003	TPDO2 mapping parameter: Application object 3 0x00000000 ... [0x00000000] ... 0xFFFFFFFF	Mapping entry 3 for TPDO2.
0x1A01:004	TPDO2 mapping parameter: Application object 4 0x00000000 ... [0x00000000] ... 0xFFFFFFFF	Mapping entry 4 for TPDO2.

Configuring the network

CANopen

CANopen data mapping



Parameter	Name / value range / [default setting]	Info
0x1A01:005	TPDO2 mapping parameter: Application object 5 0x00000000 ... [0x00000000] ... 0xFFFFFFFF	Mapping entry 5 for TPDO2.
0x1A01:006	TPDO2 mapping parameter: Application object 6 0x00000000 ... [0x00000000] ... 0xFFFFFFFF	Mapping entry 6 for TPDO2.
0x1A01:007	TPDO2 mapping parameter: Application object 7 0x00000000 ... [0x00000000] ... 0xFFFFFFFF	Mapping entry 7 for TPDO2.
0x1A01:008	TPDO2 mapping parameter: Application object 8 0x00000000 ... [0x00000000] ... 0xFFFFFFFF	Mapping entry 8 for TPDO2.
0x1A02:000	TPDO3 mapping parameter: Number of mapped application objects in TPDO 0 ... [0] ... 8	Number of objects mapped in TPDO3.
0x1A02:001	TPDO3 mapping parameter: Application object 1 0x00000000 ... [0x00000000] ... 0xFFFFFFFF	Mapping entry 1 for TPDO3.
0x1A02:002	TPDO3 mapping parameter: Application object 2 0x00000000 ... [0x00000000] ... 0xFFFFFFFF	Mapping entry 2 for TPDO3.
0x1A02:003	TPDO3 mapping parameter: Application object 3 0x00000000 ... [0x00000000] ... 0xFFFFFFFF	Mapping entry 3 for TPDO3.
0x1A02:004	TPDO3 mapping parameter: Application object 4 0x00000000 ... [0x00000000] ... 0xFFFFFFFF	Mapping entry 4 for TPDO3.
0x1A02:005	TPDO3 mapping parameter: Application object 5 0x00000000 ... [0x00000000] ... 0xFFFFFFFF	Mapping entry 5 for TPDO3.
0x1A02:006	TPDO3 mapping parameter: Application object 6 0x00000000 ... [0x00000000] ... 0xFFFFFFFF	Mapping entry 6 for TPDO3.
0x1A02:007	TPDO3 mapping parameter: Application object 7 0x00000000 ... [0x00000000] ... 0xFFFFFFFF	Mapping entry 7 for TPDO3.
0x1A02:008	TPDO3 mapping parameter: Application object 8 0x00000000 ... [0x00000000] ... 0xFFFFFFFF	Mapping entry 8 for TPDO3.



8.5.10 CANopen service data objects

Service data objects (SDOs) make it possible to read and write all parameters of the inverter via CANopen.

Details

- Two independent SDO channels are provided at the same time. SDO channel 1 is always active. SDO channel 2 can be activated via [0x2301:005 \(P510.05\)](#).
- The identifiers for SDO1 and SDO2 are generated from the basic identifier (in compliance with the "Predefined Connection Set") and the node address set.
- An SDO is always transmitted with confirmation, i. e. the reception of an SDO frame is acknowledged by the receiver.

Structure of the SDO frame user data

The user data are shown in Motorola format:

1st byte	2nd byte	3rd byte	4th byte	5th byte	6th byte	7th byte	8th byte
Command	Index		Subindex	Data 1	Data 2	Data 3	Data 4
See table below.	LOW byte	HIGH byte		LOW word		HIGH word	
	Address of the parameter to be read or written.			LOW byte	HIGH byte	LOW byte	HIGH byte

The following commands can be transmitted or received for writing and reading the parameters:

Command	1st byte		Data length	Info
	hex	dec		
Write request	0x23	35	4 bytes	Writing of a parameter to the inverter.
	0x2B	43	2 bytes	
	0x2F	47	1 byte	
	0x21	33	Block	
Write response	0x60	96	4 bytes	Inverter acknowledges a write request.
Read request	0x40	64	4 bytes	Reading of a parameter from the inverter.
Read response	0x43	67	4 bytes	Inverter response to a read request with the current parameter value.
	0x4B	75	2 bytes	
	0x4F	79	1 byte	
	0x41	65	Block	
Error response	0x80	128	4 bytes	Inverter response to the incorrect execution of the read/write request.

More precisely, the command byte comprises the following information:

Command	1st byte							
	Command specifier (cs)			Toggle (t)	Length*		e	s
	Bit 7	Bit 6	Bit 5	Bit 4	Bit 3	Bit 2	Bit 1	Bit 0
Write request	0	0	1	0	0/1	0/1	1	1
Write response	0	1	1	0	0	0	0	0
Read request	0	1	0	0	0	0	0	0
Read response	0	1	0	0	0/1	0/1	1	1
Error response	1	0	0	0	0	0	0	0

*Bit coding of the length: 00 = 4 bytes, 01 = 3 bytes, 10 = 2 bytes, 11 = 1 byte
e: expedited (shortened block service)
s: segmented (normal block service)

More commands are defined in the DS301 V4.02 CANopen specification (e.g. segmented transfer).

Configuring the network

CANopen
CANopen error responses



Maximally 4 bytes are available for parameter value entries. Depending on the data format, they are assigned as follows:

5th byte	6th byte	7th byte	8th byte
Parameter value (1 byte)	0x00	0x00	0x00
Parameter value (2 bytes)		0x00	0x00
LOW byte	HIGH byte		
Parameter value (4 bytes)			
LOW word		HIGH word	
LOW byte	HIGH byte	LOW byte	HIGH byte



The parameter attribute list in the annex also specifies a scaling factor. The scaling factor is relevant to the transmission of parameter values which are represented with one or several decimal positions in the parameter list. If the scaling factor is > 1, before the transmission, the value must be multiplied with the scaling factor specified, so that the value can be transferred completely (as an integer value). On the SDO-client side, the integer value must then be divided by the scaling factor again, in order to receive the original value with decimal positions.

Parameter	Name / value range / [default setting]	Info
0x1200:000	SDO1 server parameter: Highest sub-index supported • Read only	
0x1200:001	SDO1 server parameter: COB-ID client -> server (rx) • Read only	Display of the receive identifier for SDO server channel 1 (basic SDO channel). • According to DS301 V4.02, the basic SDO channel can neither be changed nor deactivated.
0x1200:002	SDO1 server parameter: COB-ID server -> client (tx) • Read only	Display of the transmit identifier for SDO server channel 1 (basic SDO channel). • According to DS301 V4.02, the basic SDO channel can neither be changed nor deactivated.
0x1201:000	SDO2 server parameter: Highest sub-index supported • Read only	
0x1201:001	SDO2 server parameter: COB-ID client -> server (rx) 0x00000000 ... [0x80000640] ... 0xFFFFFFFF	Specification of the receive identifier for SDO server channel 2. • If SDO server channel 2 is activated via 0x2301:005 (P510.05), this parameter is set to the value "node address + 0x640". This default setting can be changed.
0x1201:002	SDO2 server parameter: COB-ID server -> client (tx) 0x00000000 ... [0x800005C0] ... 0xFFFFFFFF	Specification of the transmit identifier for SDO server channel 2. • If SDO server channel 2 is activated via 0x2301:005 (P510.05), this parameter is set to the value "node address + 0x5C0". This default setting can be changed.
0x1201:003	SDO2 server parameter: Node-ID of the SDO client 1 ... [0] ... 127	Specification of the node address for the SDO client.
0x2301:005 (P510.05)	CANopen settings: Activate SDO2 channel (CANopen sett.: SDO2 channel)	1 = activate SDO server channel 2.
	0 Not active	
	1 Active	

8.5.11 CANopen error responses

The response to CANopen errors such as missing PDOs or heartbeat frames can be configured via the following parameters.

Parameter	Name / value range / [default setting]	Info
0x1029:000	Error behavior: Highest sub-index supported • Read only	



Configuring the network

CANopen
CANopen error responses

Parameter	Name / value range / [default setting]	Info
0x1029:001	Error behavior: Communication error	Selection of the NMT state to which the inverter is to change automatically if a failure of a CANopen node or an internal error is detected in the "Operational" state. These also include the following communication errors: <ul style="list-style-type: none"> • Change-over of the CAN interface to the "Bus-off" state. • Occurrence of a "Heartbeat Event".
	0 Status -> Pre-operational	In the "Pre-operational" state, network management, sync, and emergency telegrams as well as parameter data can be received; process data, however, are ignored.
	1 No status change	
	2 Status -> Stopped	In the "Stopped" state, only network management telegrams can be received.
0x2857:001	CANopen monitoring: RPDO1-Timeout <ul style="list-style-type: none"> • For further possible settings, see parameter 0x2D45:001 (P310.01). 196 	Selection of the response to triggering the RPDO1 time monitoring. Associated error code: <ul style="list-style-type: none"> • 33425 0x8291 - CAN: RPDO1 time-out
	3 Fault	▶ Error types 113
0x2857:002	CANopen monitoring: RPDO2-Timeout <ul style="list-style-type: none"> • For further possible settings, see parameter 0x2D45:001 (P310.01). 196 	Selection of the response to triggering the RPDO2 time monitoring. Associated error code: <ul style="list-style-type: none"> • 33426 0x8292 - CAN: RPDO2 time-out
	3 Fault	▶ Error types 113
0x2857:003	CANopen monitoring: RPDO3-Timeout <ul style="list-style-type: none"> • For further possible settings, see parameter 0x2D45:001 (P310.01). 196 	Selection of the response to triggering the RPDO3 time monitoring. Associated error code: <ul style="list-style-type: none"> • 33427 0x8293 - CAN: RPDO3 time-out
	3 Fault	▶ Error types 113
0x2857:005	CANopen monitoring: Heartbeat-Timeout Consumer 1 <ul style="list-style-type: none"> • For further possible settings, see parameter 0x2D45:001 (P310.01). 196 	Selection of the response with "Heartbeat Event" in consumer 1. Associated error code: <ul style="list-style-type: none"> • 33156 0x8184 - CAN: heartbeat time-out consumer 1
	3 Fault	▶ Error types 113
0x2857:006	CANopen monitoring: Heartbeat-Timeout Consumer 2 <ul style="list-style-type: none"> • For further possible settings, see parameter 0x2D45:001 (P310.01). 196 	Selection of the response with "Heartbeat Event" in consumer 2. Associated error code: <ul style="list-style-type: none"> • 33157 0x8185 - CAN: heartbeat time-out consumer 2
	3 Fault	▶ Error types 113
0x2857:007	CANopen monitoring: Heartbeat-Timeout Consumer 3 <ul style="list-style-type: none"> • For further possible settings, see parameter 0x2D45:001 (P310.01). 196 	Selection of the response with "Heartbeat Event" in consumer 3. Associated error code: <ul style="list-style-type: none"> • 33158 0x8186 - CAN: heartbeat time-out consumer 3
	3 Fault	▶ Error types 113
0x2857:008	CANopen monitoring: Heartbeat-Timeout Consumer 4 <ul style="list-style-type: none"> • For further possible settings, see parameter 0x2D45:001 (P310.01). 196 	Selection of the response with "Heartbeat Event" in consumer 4. Associated error code: <ul style="list-style-type: none"> • 33159 0x8187 - CAN: heartbeat time-out consumer 4
	3 Fault	▶ Error types 113
0x2857:010	CANopen monitoring: "Bus-off" state change <ul style="list-style-type: none"> • For further possible settings, see parameter 0x2D45:001 (P310.01). 196 	Selection of the response to changing to the "Bus off" state. Associated error code: <ul style="list-style-type: none"> • 33154 0x8182 - CAN: bus off
	2 Trouble	▶ Error types 113
0x2857:011	CANopen monitoring: Warning <ul style="list-style-type: none"> • For further possible settings, see parameter 0x2D45:001 (P310.01). 196 	Selection of the response that is executed in the case of too many incorrectly sent or received CAN telegrams (> 96). Associated error code: <ul style="list-style-type: none"> • 33155 0x8183 - CAN: warning
	1 Warning	▶ Error types 113

Configuring the network

CANopen

CANopen diagnostic counter



8.5.12 CANopen diagnostic counter

The following parameters serve to diagnose the communication activities between the inverter and the CANopen network. The counters are free-running, i. e. when the maximum value has been reached, the respective counter starts at 0 again.

Parameter	Name / value range / [default setting]	Info
0x230A:000	CANopen statistics: Highest subindex • Read only	Number of frame and error counters.
0x230A:001 (P580.01)	CANopen statistics: PDO1 received (CAN statistics: PDO1 received) • Read only	Display of the number of PDO1 telegrams received.
0x230A:002 (P580.02)	CANopen statistics: PDO2 received (CAN statistics: PDO2 received) • Read only	Display of the number of PDO2 telegrams received.
0x230A:003 (P580.03)	CANopen statistics: PDO3 received (CAN statistics: PDO3 received) • Read only	Display of the number of PDO3 telegrams received.
0x230A:005 (P580.05)	CANopen statistics: PDO1 transmitted (CAN statistics: PDO1 transmitted) • Read only	Display of the number of PDO1 telegrams sent.
0x230A:006 (P580.06)	CANopen statistics: PDO2 transmitted (CAN statistics: PDO2 transmitted) • Read only	Display of the number of PDO2 telegrams sent.
0x230A:007 (P580.07)	CANopen statistics: PDO3 transmitted (CAN statistics: PDO3 transmitted) • Read only	Display of the number of PDO3 telegrams sent.
0x230A:009 (P580.09)	CANopen statistics: SDO1 telegrams (CAN statistics: SDO1 counter) • Read only	Display of the number of SDO1 telegrams.
0x230A:010 (P580.10)	CANopen statistics: SDO2 telegrams (CAN statistics: SDO2 counter) • Read only	Display of the number of SDO2 telegrams.
0x230B (P518.00)	CANopen error counter (CAN errorcounter) • Read only	Display of the total number of CAN faults that have occurred.

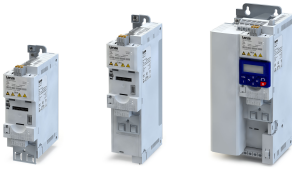



8.5.13 CANopen LED status displays

Information about the CAN bus status can be obtained quickly via the "CAN-RUN" and "CAN-ERR" LED displays on the front of the inverter.

The meaning can be seen from the tables below.

Inverter not active on the CAN bus (yet)



LED "CAN-RUN"	LED "CAN-ERR"	Meaning
off	off	Inverter is not active on the CAN bus.
	 on	"Bus Off" state.
 Both LEDs are flickering alternately		Automatic baud rate detection active.

Inverter active on the CAN bus

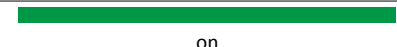
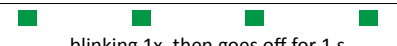
The green "CAN-RUN" LED indicates the CANopen state:

LED "CAN-RUN"	CANopen state
 blinking fast (5 Hz)	Pre-Operational
 on	Operational
 blinking 1x, then goes off for 1 s	Stopped

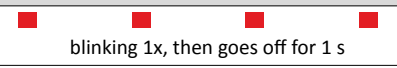
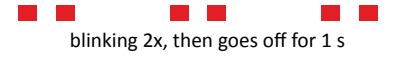
The red "CAN-ERR" LED indicates a CANopen error:

LED "CAN-ERR"	CANopen error
 blinking 1x, then goes off for 1 s	Warning Limit reached
 blinking 2x, then goes off for 1 s	Heartbeat Event
 blinking 3x, then goes off for 1 s	Sync message error (only possible in the "Operational" state)

8.5.14 Resetting the CANopen interface

The following parameter can be used to restart or stop communication. Optionally it is also possible to reset all communication parameters to the default status.

Details

A restart of communication is required after changes of the interface configuration (e. g. node address and baud rate) in order that the changed settings become effective.

For restarting communication, there are two options:

- Switch inverter off and on again.
- Set the selection = "Restart with current values [1]" in [0x2300 \(P508.00\)](#).

Parameter	Name / value range / [default setting]	Info
0x2300 (P508.00)	CANopen communication (CANopen comm.) • Setting can only be changed if the inverter is inhibited.	Restart / stop communication. • After successful execution, the value 0 is shown.
	0 No action/no error	Only status feedback
	1 Restart with current values	Restart communication with the current values.
	2 Restart with default values	Restart communication with the standard values of the CAN parameters (0x1000 ... 0x1FFF and 0x2301).
	5 Stop network communication	Stop communication. • The "Stop Remote Node" NMT command is executed. After successful execution of this command, only the reception of network management frames is possible.
	10 In progress	Only status feedback
	11 Action cancelled	
	12 Error	

Configuring the network

CANopen
CANopen - short setup

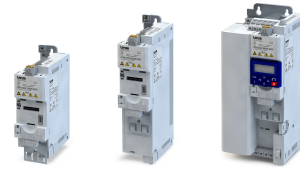

8.5.15 CANopen - short setup

In the following, the steps required for controlling the inverter via CANopen are described.

Parameterisation required

1. Set the CANopen node address.
 - Each network node must be provided with a unique node address.
 - Details: [▶ CANopen node address](#) [📖 233](#)
2. Set the CANopen baud rate.
 - Default setting: 500 kbps
 - Details: [▶ CANopen baud rate](#) [📖 234](#)
3. Optional: Configure inverter as "mini master".
 - Required if the initialisation of the CANopen network and the associated status change from "Pre-Operational" to "Operational" is not effected by a higher-level host system.
 - Details: [▶ CANopen initialisation](#) [📖 235](#)
4. Optional: Change the response of the inverter to the triggering of the RPDO time monitoring.
 - Default setting: In case of missing RPDOs, an error is triggered.
 - Details: [▶ CANopen error responses](#) [📖 248](#)
5. Save parameter settings: `0x2022:003 (P700.03) = "On / start [1]"`.
6. Switch the inverter off and then on again in order that the changed communication settings can get effective.
7. Program the master so that the following SDO messages are sent to the inverter:
 1. `0x2631:037 (P400.37) = 1` (activate network control)
 2. `0x2860:001 (P201.01) = 5` (set network as standard setpoint source)
 3. PDO mapping and configuration of the process data objects RPDO1 and TPDO1 (see the sections "[RPDO1 mapping](#)" and "[TPDO1 mapping](#)").
8. Control inverter via RPDO1 (and evaluate the current status via TPDO1).
 - For assignment of the control word and setpoint selection, see section "[RPDO1 mapping](#)".
 - For assignment of the status word and actual value output, see section "[TPDO1 mapping](#)".
 - Acceleration `0x2917 (P220.00)` and deceleration `0x2918 (P221.00)` can be set/changed via SDO messages.



In the default setting, the digital input DI1 is assigned with the "Run" function. If the network control is activated, this function serves as "start enable" for start commands via network. Hence, the digital input DI1 must be set to HIGH level in order that the motor can be started via network. [▶ Start / stop motor](#) [📖 499](#)



RPDO1 mapping

The RPDO1 is used to control the inverter.

Changing the identifier (COB-ID) and the PDO mapping only allows the following procedure:

1. Set RPDO1 to "invalid": Set bit 31 in the identifier [0x1400:001 \(P540.01\)](#) to "1".
2. Set RPDO1 mapping to "invalid": [0x1600:000](#) = set 0.
3. Map NetWordIN1 data word [0x4008:001 \(P590.01\)](#) to RPDO1:
[0x1600:001](#) = set 0x40080110.
4. Map Network setpoint frequency (0.1) [0x400B:003 \(P592.03\)](#) to RPDO1:
[0x1600:002](#) = set 0x400B0310.
5. Set RPDO1 mapping to "valid" again: [0x1600:000](#) = set 2 (number of mapped parameters).
6. Optional: Set time-out time for monitoring the data reception in [0x1400:005 \(P540.05\)](#) in [ms].
 - Default setting: 100 ms
7. Change identifier for RPDO1 (optional) and set RPDO1 to "valid" again: Write the new identifier into [0x1400:001 \(P540.01\)](#) and simultaneously set bit 31 to "0".
 - Default setting: 0x200 + node address (hex)
 - Example: Node address = 10 (0xA) and basic identifier = default setting:
Identifier to be written into [0x1400:001 \(P540.01\)](#) = 0x200 + 0xA = 0x20A (0b0011 0000 1010)

Function assignment of the NetWordIN1 data word (byte 1+2 of the RPDO1)

Bit	Default setting	For details and configuration, see
0	Not active (reserve)	0x400E:001 (P505.01)
1	Not active (reserve)	0x400E:002 (P505.02)
2	Activate quick stop	0x400E:003 (P505.03)
3	Not active (reserve)	0x400E:004 (P505.04)
4	Run forward (CW)	0x400E:005 (P505.05)
5	Activate preset (bit 0)	0x400E:006 (P505.06)
6	Activate preset (bit 1)	0x400E:007 (P505.07)
7	Reset error	0x400E:008 (P505.08)
8	Not active (reserve)	0x400E:009 (P505.09)
9	Activate DC braking	0x400E:010 (P505.10)
10	Not active (reserve)	0x400E:011 (P505.11)
11	Not active (reserve)	0x400E:012 (P505.12)
12	Invert rotation	0x400E:013 (P505.13)
13	Not active (reserve)	0x400E:014 (P505.14)
14	Not active (reserve)	0x400E:015 (P505.15)
15	Not active (reserve)	0x400E:016 (P505.16)

Specifying the frequency setpoint (byte 3+4 of the RPDO1)

- The specification is made unsigned (independent of the direction of rotation) as integer in the resolution [0.1 Hz].
- The direction of rotation is defined in the default setting via bit 12 of the NetWordIN1 data word.
- Example: 456 ≙ 45.6 Hz

Configuring the network

CANopen
CANopen - short setup



TPDO1 mapping

The TPDO1 is used for the output of status information and the actual frequency value.

Changing the identifier (COB-ID) and the PDO mapping only allows the following procedure:

1. Set TPDO1 to "invalid": Set bit 31 in the identifier [0x1800:001 \(P550.01\)](#) to "1".
2. Set TPDO1 mapping to "invalid": [0x1A00:000](#) = set 0.
3. Map NetWordOUT1 data word [0x400A:001 \(P591.01\)](#) to TPDO1:
[0x1A00:001](#) = set 0x400A0110.
4. MapFrequency (0.1) [0x400B:003 \(P592.03\)](#) to TPDO1:
[0x1A00:002](#) = set 0x400C0310.
5. Set TPDO1 mapping to "valid" again: [0x1A00:000](#) = set 2 (number of mapped parameters).
6. Optional: Set Transmission type in [0x1800:002 \(P550.02\)](#) and Event timer in [0x1800:005 \(P550.05\)](#).
 - Default setting: Cyclic transmission every 20 ms.
7. Change identifier for TPDO1 (optional) and set TPDO1 to "valid" again: Write the new identifier into [0x1800:001 \(P550.01\)](#) and simultaneously set bit 31 to "0".
 - Default setting: 0x40000180 + node address (hex)
 - Example: Node address = 10 (0xA) and TPDO1 basic identifier = default setting:
Identifier to be written into [0x1800:001 \(P550.01\)](#) = 0x40000180 + 0xA = 0x4000018A
(0b0100 0000 0000 0000 0000 0001 1000 1010)

Status assignment of the NetWordOUT1 data word (byte 1+2 of the TPDO1)

Bit	Default setting	For details and configuration, see
0	Ready for operation	0x2634:010 (P420.10)
1	Not connected	0x2634:011 (P420.11)
2	Operation enabled	0x2634:012 (P420.12)
3	Error active	0x2634:013 (P420.13)
4	Not connected	0x2634:014 (P420.14)
5	Quick stop active	0x2634:015 (P420.15)
6	Running	0x2634:016 (P420.16)
7	Device warning active	0x2634:017 (P420.17)
8	Not connected	0x2634:018 (P420.18)
9	Not connected	0x2634:019 (P420.19)
10	Setpoint speed reached	0x2634:020 (P420.20)
11	Current limit reached	0x2634:021 (P420.21)
12	Actual speed = 0	0x2634:022 (P420.22)
13	Rotational direction reversed	0x2634:023 (P420.23)
14	Release holding brake	0x2634:024 (P420.24)
15	Safe torque off (STO) active	0x2634:025 (P420.25)

Output of the actual frequency value (byte 3+4 of the TPDO1)

- The output is made unsigned (independent of the direction of rotation) as integer in the resolution [0.1 Hz].
- An active reversal is displayed via bit 13 of the NetWordOUT1 data word.
- Example: 456 ≙ 45.6 Hz



8.6 Modbus RTU



Modbus is an internationally approved, asynchronous, serial communication protocol, designed for commercial and industrial automation applications.

- Detailed information on the Modbus can be found on the web page of the international Modbus Organization, USA, who also further develop the Modbus protocol: <http://www.modbus.org>
- Information about the dimensioning of a Modbus network can be found in the configuration document for the inverter.

Preconditions

Control unit (CU) of the inverter is provided with Modbus.

8.6.1 Modbus RTU introduction

- The process of data transmission distinguishes between three different operating modes: Modbus ASCII, Modbus RTU, and Modbus TCP. This chapter describes the Modbus RTU operating mode ("Remote Terminal Unit").
- The Modbus protocol is based on a master/slave architecture where the inverter always works as slave.
- The Modbus network only permits one master (at a time) sending commands and requests. The master is also the sole instance to be allowed to initiate Modbus communication. No direct communication takes place between the slaves.
- The physical interface corresponds to TIA/EIA-485-A which is very common and suitable for the industrial environment. This interface enables baud rates from 2400 to 115200 kbps.
- The inverter supports Modbus function codes 3, 6, 16 (0x10) and 23 (0x17).

8.6.2 Modbus RTU node address

Each network node must be provided with a unique node address.

Details

- The node address of the inverter can be optionally set in [0x2321:001 \(P510.01\)](#) or using the DIP switches on the device labelled with "1" ... "128".
- The setting that is active when the inverter is switched on is the effective setting.
- The labelling of the DIP switches corresponds to the values of the individual DIP switches for determining the node address (see the following example).
- The node address 0 is reserved for messages to all nodes ("Broadcast").
- The active node address is shown in [0x2322:001 \(P511.01\)](#).

Example of how the node address is set via the DIP switches

DIP switch	128	64	32	16	8	4	2	1
Setting	OFF	OFF	OFF	ON	OFF	ON	ON	ON
Value	0	0	0	16	0	4	2	1
Node address	= sum of all values = 16 + 4 + 2 + 1 = 23							

Parameter	Name / value range / [default setting]	Info
0x2321:001 (P510.01)	Modbus settings: Node ID (Modbus sett.: Node ID) 1 ... [1] ... 247	Optionally setting of the node address (instead of setting via DIP switches 1 ... 128). <ul style="list-style-type: none"> • The node address set here only becomes effective if DIP switches 1 ... 128 have been set to OFF before mains switching. • A change in the node address only becomes effective after a restart of Modbus communication.
0x2323 (P509.00)	Modbus switch position (Modbus switch) <ul style="list-style-type: none"> • Read only 	Display of the DIP switch setting at the last mains power-on. <ul style="list-style-type: none"> • The value displayed corresponds to the sum of all DIP switch values (except for DIP switches for terminating resistor).

Configuring the network

Modbus RTU
Modbus RTU baud rate



8.6.3 Modbus RTU baud rate

All network nodes must be set to the same baud rate.

Details

- If the DIP switch labelled with "b" is in the OFF position at switch-on, the automatic baud rate detection function is active. If it is in the ON position, the setting in [0x2321:002 \(P510.02\)](#) applies instead.
- If the automatic baud rate detection function is activated, the first 5 ... 10 messages are lost after switch-on.
- The active baud rate is displayed in [0x2322:002 \(P511.02\)](#).

Parameter	Name / value range / [default setting]	Info
0x2321:002 (P510.02)	Modbus settings: Baud rate (Modbus sett.: Baud rate)	Optionally setting of the baud rate (instead of setting via DIP switch b). <ul style="list-style-type: none"> • The baud rate set here is only effective if DIP switch b was set to ON before mains switching. Otherwise automatic baud rate detection is active. • A change in the baud rate only becomes effective after a restart of Modbus communication. • If the automatic baud rate detection function is activated, the first 5 ... 10 messages are lost after switch-on.
	0 Automatic	
	1 2400 bps	
	2 4800 bps	
	3 9600 bps	
	4 19200 bps	
	5 38400 bps	
	6 57600 bps	
7 115200 bps		
0x2323 (P509.00)	Modbus switch position (Modbus switch) <ul style="list-style-type: none"> • Read only 	Display of the DIP switch setting at the last mains power-on. <ul style="list-style-type: none"> • The value displayed corresponds to the sum of all DIP switch values (except for DIP switches for terminating resistor).

8.6.4 Modbus RTU data format

All network nodes must be set to the same data format.

Details

- If the DIP switch labelled with "a" is in the OFF position at switch-on, the automatic data format detection function is active. If it is in the ON position, the setting in [0x2321:003 \(P510.03\)](#) applies instead.
- If the automatic data format detection function is activated, the first 5 ... 10 messages are lost after switch-on.
- The active data format is displayed in [0x2322:003 \(P511.03\)](#).

Parameter	Name / value range / [default setting]	Info
0x2321:003 (P510.03)	Modbus settings: Data format (Modbus sett.: Data format)	Definition of the parity and stop bits.
	0 Automatic	Automatic data format detection. <ul style="list-style-type: none"> • With this setting, the first 5 ... 10 messages are lost after switch-on.
	1 8, E, 1	8 data bits, even parity, 1 stop bit
	2 8, O, 1	8 data bits, odd parity, 1 stop bit
	3 8, N, 2	8 data bits, no parity bit, 2 stop bits
0x2323 (P509.00)	Modbus switch position (Modbus switch) <ul style="list-style-type: none"> • Read only 	Display of the DIP switch setting at the last mains power-on. <ul style="list-style-type: none"> • The value displayed corresponds to the sum of all DIP switch values (except for DIP switches for terminating resistor).

8.6.5 Modbus RTU time-out monitoring

The response to the missing Modbus messages can be configured via the following parameters.

Parameter	Name / value range / [default setting]	Info
0x2858:001 (P515.01)	Modbus monitoring: Response to time-out (Modbus monit.: Resp. Time-out) <ul style="list-style-type: none"> • For further possible settings, see parameter 0x2D45:001 (P310.01). □ 196 	Selection of the response executed if no valid messages have been received via the Modbus for a longer time than the time-out period set in 0x2858:002 (P515.02) . Associated error code: <ul style="list-style-type: none"> • 33185 0x81A1 - Modbus: network time-out
	3 Fault	▶ Error types □ 113



Configuring the network

Modbus RTU
Modbus RTU diagnostics

Parameter	Name / value range / [default setting]	Info
0x2858:002 (P515.02)	Modbus monitoring: Time-out time (Modbus monit.: Time-out time) 0.0 ... [2.0] ... 300.0 s	Time-out period for monitoring the message reception via Modbus.

8.6.6 Modbus RTU diagnostics

The following parameters serve to diagnose the communication activities between the inverter and the Modbus network.

Parameter	Name / value range / [default setting]	Info
0x2322:001 (P511.01)	Active Modbus settings: Active node ID (Modbus diag.: Active node ID) • Read only	Display of the active node address.
0x2322:002 (P511.02)	Active Modbus settings: Active baud rate (Modbus diag.: Active baud rate) • Read only	Display of the active baud rate.
0x2322:003 (P511.03)	Active Modbus settings: Data format (Modbus diag.: Data format) • Read only	Display of the active data format.
0x232A:001 (P580.01)	Modbus statistics: Messages received (Modbus statistic: Mess. received) • Read only	Display of the total number of messages received. • This counter counts both valid and invalid messages. • After the maximum value has been reached, the counter starts again "0".
0x232A:002 (P580.02)	Modbus statistics: Valid messages received (Modbus statistic: Val. mess. rec.) • Read only	Display of the number of valid messages received. • After the maximum value has been reached, the counter starts again "0".
0x232A:003 (P580.03)	Modbus statistics: Messages with exceptions (Modbus statistic: Mess. w. exc.) • Read only	Display of the number of messages with exceptions that have been received. • After the maximum value has been reached, the counter starts again "0".
0x232A:004 (P580.04)	Modbus statistics: Messages with errors (Modbus statistic: Mess. w. errors) • Read only	Display of the number of messages received with a faulty data integrity (parity, CRC). • After the maximum value has been reached, the counter starts again "0".
0x232A:005 (P580.05)	Modbus statistics: Messages sent (Modbus statistic: Messages sent) • Read only	Display of the total number of messages sent. • After the maximum value has been reached, the counter starts again "0".
0x232E:001 (P583.01)	Modbus diagnostics of last Rx data: Offset (Rx data diagn.: Rx data offset) 0 ... [0] ... 240	For purposes of diagnostics, the last message received (max. 16 bytes) is shown in 0x232E:002 (P583.02) ... 0x232E:017 (P583.17) . For longer messages, an offset can be specified here, indicating from which byte of the message the display of the 16 bytes is to start.

Configuring the network

Modbus RTU

Modbus RTU diagnostics



Parameter	Name / value range / [default setting]	Info
0x232E:002 (P583.02)	Modbus diagnostics of last Rx data: Data byte 0 (Rx data diagn.: Last RxD byte0) • Read only	Display of the message received last.
0x232E:003 (P583.03)	Modbus diagnostics of last Rx data: Data byte 1 (Rx data diagn.: Last RxD byte1) • Read only	
0x232E:004 (P583.04)	Modbus diagnostics of last Rx data: Data byte 2 (Rx data diagn.: Last RxD byte2) • Read only	
0x232E:005 (P583.05)	Modbus diagnostics of last Rx data: Data byte 3 (Rx data diagn.: Last RxD byte3) • Read only	
0x232E:006 (P583.06)	Modbus diagnostics of last Rx data: Data byte 4 (Rx data diagn.: Last RxD byte4) • Read only	
0x232E:007 (P583.07)	Modbus diagnostics of last Rx data: Data byte 5 (Rx data diagn.: Letzt RxD-Byte5) • Read only	
0x232E:008 (P583.08)	Modbus diagnostics of last Rx data: Data byte 6 (Rx data diagn.: Last RxD byte6) • Read only	
0x232E:009 (P583.09)	Modbus diagnostics of last Rx data: Data byte 7 (Rx data diagn.: Last RxD byte7) • Read only	
0x232E:010 (P583.10)	Modbus diagnostics of last Rx data: Data byte 8 (Rx data diagn.: Last RxD byte8) • Read only	
0x232E:011 (P583.11)	Modbus diagnostics of last Rx data: Data byte 9 (Rx data diagn.: Last RxD byte9) • Read only	
0x232E:012 (P583.12)	Modbus diagnostics of last Rx data: Data byte 10 (Rx data diagn.: Last RxD byte10) • Read only	
0x232E:013 (P583.13)	Modbus diagnostics of last Rx data: Data byte 11 (Rx data diagn.: Last RxD byte11) • Read only	
0x232E:014 (P583.14)	Modbus diagnostics of last Rx data: Data byte 12 (Rx data diagn.: Last RxD byte12) • Read only	
0x232E:015 (P583.15)	Modbus diagnostics of last Rx data: Data byte 13 (Rx data diagn.: Last RxD byte13) • Read only	
0x232E:016 (P583.16)	Modbus diagnostics of last Rx data: Data byte 14 (Rx data diagn.: Last RxD byte14) • Read only	
0x232E:017 (P583.17)	Modbus diagnostics of last Rx data: Data byte 15 (Rx data diagn.: Last RxD byte15) • Read only	
0x232F:001 (P585.01)	Modbus diagnostics of last Tx data: Offset (Tx data diagn.: Tx data offset) 0 ... [0] ... 240	For purposes of diagnostics, the last message sent (max. 16 bytes) is shown in 0x232F:002 (P585.02) ... 0x232F:017 (P585.17) . For longer messages, an offset can be specified here, indicating from which byte of the message the display of the 16 bytes is to start.



Configuring the network

Modbus RTU
Modbus RTU diagnostics

Parameter	Name / value range / [default setting]	Info
0x232F:002 (P585.02)	Modbus diagnostics of last Tx data: Data byte 0 (Tx data diagn.: Last TxD byte0) • Read only	Display of the message sent last.
0x232F:003 (P585.03)	Modbus diagnostics of last Tx data: Data byte 1 (Tx data diagn.: Last TxD Byte1) • Read only	
0x232F:004 (P585.04)	Modbus diagnostics of last Tx data: Data byte 2 (Tx data diagn.: Last TxD byte2) • Read only	
0x232F:005 (P585.05)	Modbus diagnostics of last Tx data: Data byte 3 (Tx data diagn.: Last TxD byte3) • Read only	
0x232F:006 (P585.06)	Modbus diagnostics of last Tx data: Data byte 4 (Tx data diagn.: Last TxD byte4) • Read only	
0x232F:007 (P585.07)	Modbus diagnostics of last Tx data: Data byte 5 (Tx data diagn.: Last TxD byte5) • Read only	
0x232F:008 (P585.08)	Modbus diagnostics of last Tx data: Data byte 6 (Tx data diagn.: Last TxD byte6) • Read only	
0x232F:009 (P585.09)	Modbus diagnostics of last Tx data: Data byte 7 (Tx data diagn.: Last TxD byte7) • Read only	
0x232F:010 (P585.10)	Modbus diagnostics of last Tx data: Data byte 8 (Tx data diagn.: Last TxD byte8) • Read only	
0x232F:011 (P585.11)	Modbus diagnostics of last Tx data: Data byte 9 (Tx data diagn.: Last TxD byte9) • Read only	
0x232F:012 (P585.12)	Modbus diagnostics of last Tx data: Data byte 10 (Tx data diagn.: Last TxD byte10) • Read only	
0x232F:013 (P585.13)	Modbus diagnostics of last Tx data: Data byte 11 (Tx data diagn.: Last TxD byte11) • Read only	
0x232F:014 (P585.14)	Modbus diagnostics of last Tx data: Data byte 12 (Tx data diagn.: Last TxD byte12) • Read only	
0x232F:015 (P585.15)	Modbus diagnostics of last Tx data: Data byte 13 (Tx data diagn.: Last TxD byte13) • Read only	
0x232F:016 (P585.16)	Modbus diagnostics of last Tx data: Data byte 14 (Tx data diagn.: Last TxD byte14) • Read only	
0x232F:017 (P585.17)	Modbus diagnostics of last Tx data: Data byte 15 (Tx data diagn.: Last TxD byte15) • Read only	

Configuring the network

Modbus RTU
Modbus RTU function codes



8.6.7 Modbus RTU function codes

The mode of access to inverter data (parameters) is controlled via function codes.

Details

The inverter supports the following function codes:

Function code	Function name	Description
3	0x03	Read Holding Registers
6	0x06	Preset Single Register
16	0x10	Preset Multiple Registers
23	0x17	Read/Write 4X Registers

Addressing

- The function codes listed above exclusively refer to 4X registers in Modbus addressing.
- All data in the inverter can only be accessed via 4X registers, i.e. via register addresses from 40001.
- The 4xxx reference is implicit, i. e. given by the function code used. In the frame therefore the leading 4 is omitted in the addressing process.
- The numbering of the registers starts with 1; addressing, however, starts with 0. Therefore, for instance, the address 0 is used in the frame when register 40001 is read.

Telegram structure

Communication is established on the basis of the central medium access method. Communication is always started by a master request. The inverter (slave) then either gives a valid response or outputs an error code (provided that the request has been received and evaluated as a valid Modbus frame). Error causes can be invalid CRC checksums, function codes that are not supported, or impermissible data access.

All Modbus frames have the following basic structure:

- A "frame" consists of a PDU (Protocol Data Unit) and an ADU (Application Data Unit).
- The PDU contains the function code and the data belonging to the function code.
- The ADU serves the purposes of addressing and error detection.
- The data are represented in Big Endian format (most significant byte first).

ADU (Application Data Unit)			
Slave address	Function code	Data	Checksum (CRC)
	PDU (Protocol Data Unit)		

Error codes

Error code	Name	Cause(s)
0x01	Invalid function code	The function code is not supported by the inverter, or the inverter is in a state in which the request is not permissible or in which it cannot be processed.
0x02	Invalid data address	The combination of a start address and the length of the data to be transmitted is invalid. Example: If you have a slave with 100 registers, the first register has the address 0 and the last register has the address 99. If there is a request of four registers now, from the start address 96, the request can be processed successfully (for registers 96, 97, 98, and 99). If, however, five registers from the start address 96 are queried, this error code is returned, since the slave has no register with the address 100.
0x03	Invalid data value	The cause, however, is not that a (parameter) value is written outside the valid setting range. As a matter of principle, the Modbus protocol has no information on valid setting ranges of individual registers or their meaning.
0x04	Slave device failure	A non-correctable error has occurred while the request was processed in the inverter.



8.6.8 Modbus RTU data mapping

The process of data mapping is used for defining which Modbus registers read or write to which inverter parameters.

Variable mapping

- Via 0x232B:1 ... 24, 24 registers can be mapped variably to parameters of the inverter. Format: 0xiiiiss00 (iiii = hexadecimal index, ss = hexadecimal subindex)
- The display of the internal Modbus register numbers in 0x232C:1 ... 24 is generated automatically. Since 32-bit parameters require two registers, there is no 1:1 assignment.
- For the mappable registers, a CRC (Cyclic Redundancy Check) is executed. The checksum determined is displayed in 0x232D (P532.00). The user can read this "validation code" and use it for comparison in the Modbus master. In this way it can be checked whether the inverter currently queried is configured correctly for the respective application.

Details

- There are fixedly defined Modbus registers for common control and status words, which are located in coherent blocks, in order to facilitate communication with OPC servers and other Modbus masters. In order to access all relevant data of the inverter, only a minimum number of commands is required.
- In addition, 24 registers are provided for variable mapping, i. e. free assignment to inverter parameters.

Predefined Modbus control registers

- These registers are provided with write and read access.
- The cross-reference in column 2 leads to the detailed parameter description.

Modbus registers	Permanently assigned parameter	
	Address	Name
42101	0x400B:001 (P592.01)	AC Drive control word
42102	0x400B:005 (P592.05)	Network setpoint frequency (0.01)
42103	0x4008:002 (P590.02)	NetWordIN2
42104	0x4008:003 (P590.03)	NetWordIN3
42105	0x400B:007 (P592.07)	PID setpoint
42106	0x6071	Target torque
42107	0x4008:001 (P590.01)	NetWordIN1
42108	0x4008:004 (P590.04)	NetWordIN4
42109 ... 42121	-	Reserved

Predefined Modbus status registers

- These registers are only provided with read access.
- The cross-reference in column 2 leads to the detailed parameter description.

Modbus registers	Permanently assigned parameter	
	Address	Name
42001	0x400C:001 (P593.01)	AC Drive status word
42002	0x400C:006 (P593.06)	Frequency (0.01)
42003	0x603F (P150.00)	Error code
42004	0x400C:005 (P593.05)	Drive status
42005	0x2D89 (P106.00)	Motor voltage
42006	0x2D88 (P104.00)	Motor current
42007	0x6078 (P103.00)	Current actual value
42008	0x2DA2:002 (P108.02)	Apparent power (42008 = High Word, 42009 = Low Word)
42009		
42010	0x2D84:001 (P117.01)	Heatsink temperature
42011	0x2D87 (P105.00)	DC-bus voltage
42012	0x60FD (P118.00)	Digital inputs (only bit 16 ... bit 31)
42013	0x6077 (P107.00)	Torque actual value
42014 ... 42021	-	Reserved

Configuring the network

Modbus RTU

Modbus RTU data mapping



Parameter	Name / value range / [default setting]	Info
0x232B:001 (P530.01)	Modbus parameter mapping: Parameter 1 (Para. mapping: Parameter 1) 0x00000000 ... [0x00000000] ... 0xFFFFFFFF00	Mapping entry for Modbus register 40103.
0x232B:002 (P530.02)	Modbus parameter mapping: Parameter 2 (Para. mapping: Parameter 2) 0x00000000 ... [0x00000000] ... 0xFFFFFFFF00	Mapping entry for Modbus register 40105.
0x232B:003 (P530.03)	Modbus parameter mapping: Parameter 3 (Para. mapping: Parameter 3) 0x00000000 ... [0x00000000] ... 0xFFFFFFFF00	Mapping entry for Modbus register 40107.
0x232B:004 (P530.04)	Modbus parameter mapping: Parameter 4 (Para. mapping: Parameter 4) 0x00000000 ... [0x00000000] ... 0xFFFFFFFF00	Mapping entry for Modbus register 40109.
0x232B:005 (P530.05)	Modbus parameter mapping: Parameter 5 (Para. mapping: Parameter 5) 0x00000000 ... [0x00000000] ... 0xFFFFFFFF00	Mapping entry for Modbus register 40111.
0x232B:006 (P530.06)	Modbus parameter mapping: Parameter 6 (Para. mapping: Parameter 6) 0x00000000 ... [0x00000000] ... 0xFFFFFFFF00	Mapping entry for Modbus register 40113.
0x232B:007 (P530.07)	Modbus parameter mapping: Parameter 7 (Para. mapping: Parameter 7) 0x00000000 ... [0x00000000] ... 0xFFFFFFFF00	Mapping entry for Modbus register 40115.
0x232B:008 (P530.08)	Modbus parameter mapping: Parameter 8 (Para. mapping: Parameter 8) 0x00000000 ... [0x00000000] ... 0xFFFFFFFF00	Mapping entry for Modbus register 40117.
0x232B:009 (P530.09)	Modbus parameter mapping: Parameter 9 (Para. mapping: Parameter 9) 0x00000000 ... [0x00000000] ... 0xFFFFFFFF00	Mapping entry for Modbus register 40119.
0x232B:010 (P530.10)	Modbus parameter mapping: Parameter 10 (Para. mapping: Parameter 10) 0x00000000 ... [0x00000000] ... 0xFFFFFFFF00	Mapping entry for Modbus register 40121.
0x232B:011 (P530.11)	Modbus parameter mapping: Parameter 11 (Para. mapping: Parameter 11) 0x00000000 ... [0x00000000] ... 0xFFFFFFFF00	Mapping entry for Modbus register 40123.
0x232B:012 (P530.12)	Modbus parameter mapping: Parameter 12 (Para. mapping: Parameter 12) 0x00000000 ... [0x00000000] ... 0xFFFFFFFF00	Mapping entry for Modbus register 40125.
0x232B:013 (P530.13)	Modbus parameter mapping: Parameter 13 (Para. mapping: Parameter 13) 0x00000000 ... [0x00000000] ... 0xFFFFFFFF00	Mapping entry for Modbus register 40127.
0x232B:014 (P530.14)	Modbus parameter mapping: Parameter 14 (Para. mapping: Parameter 14) 0x00000000 ... [0x00000000] ... 0xFFFFFFFF00	Mapping entry for Modbus register 40129.
0x232B:015 (P530.15)	Modbus parameter mapping: Parameter 15 (Para. mapping: Parameter 15) 0x00000000 ... [0x00000000] ... 0xFFFFFFFF00	Mapping entry for Modbus register 40131.
0x232B:016 (P530.16)	Modbus parameter mapping: Parameter 16 (Para. mapping: Parameter 16) 0x00000000 ... [0x00000000] ... 0xFFFFFFFF00	Mapping entry for Modbus register 40133.
0x232B:017 (P530.17)	Modbus parameter mapping: Parameter 17 (Para. mapping: Parameter 17) 0x00000000 ... [0x00000000] ... 0xFFFFFFFF00	Mapping entry for Modbus register 40135.
0x232B:018 (P530.18)	Modbus parameter mapping: Parameter 18 (Para. mapping: Parameter 18) 0x00000000 ... [0x00000000] ... 0xFFFFFFFF00	Mapping entry for Modbus register 40137.
0x232B:019 (P530.19)	Modbus parameter mapping: Parameter 19 (Para. mapping: Parameter 19) 0x00000000 ... [0x00000000] ... 0xFFFFFFFF00	Mapping entry for Modbus register 40139.
0x232B:020 (P530.20)	Modbus parameter mapping: Parameter 20 (Para. mapping: Parameter 20) 0x00000000 ... [0x00000000] ... 0xFFFFFFFF00	Mapping entry for Modbus register 40141.
0x232B:021 (P530.21)	Modbus parameter mapping: Parameter 21 (Para. mapping: Parameter 21) 0x00000000 ... [0x00000000] ... 0xFFFFFFFF00	Mapping entry for Modbus register 40143.



Configuring the network

Modbus RTU
Modbus RTU data mapping

Parameter	Name / value range / [default setting]	Info
0x232B:022 (P530.22)	Modbus parameter mapping: Parameter 22 (Para. mapping: Parameter 22) 0x00000000 ... [0x00000000] ... 0xFFFFFFFF00	Mapping entry for Modbus register 40145.
0x232B:023 (P530.23)	Modbus parameter mapping: Parameter 23 (Para. mapping: Parameter 23) 0x00000000 ... [0x00000000] ... 0xFFFFFFFF00	Mapping entry for Modbus register 40147.
0x232B:024 (P530.24)	Modbus parameter mapping: Parameter 24 (Para. mapping: Parameter 24) 0x00000000 ... [0x00000000] ... 0xFFFFFFFF00	Mapping entry for Modbus register 40149.
0x232C:001 (P531.01)	Modbus register assignment: Register 1 (Reg. assigned: Register 1) • Read only	Display of the internal Modbus register number starting from which the parameter mapped in 0x232B:1 is stored. • For the first parameter mapped, always 2500.
0x232C:002 (P531.02)	Modbus register assignment: Register 2 (Reg. assigned: Register 2) • Read only	Display of the internal Modbus register number starting from which the parameter mapped in 0x232B:2 is stored. • 2500 + offset. The offset results from the data types of the previously mapped parameters.
0x232C:003 (P531.03)	Modbus register assignment: Register 3 (Reg. assigned: Register 3) • Read only	Display of the internal Modbus register number starting from which the parameter mapped in 0x232B:3 is stored. • 2500 + offset. The offset results from the data types of the previously mapped parameters.
0x232C:004 (P531.04)	Modbus register assignment: Register 4 (Reg. assigned: Register 4) • Read only	Display of the internal Modbus register number starting from which the parameter mapped in 0x232B:4 is stored. • 2500 + offset. The offset results from the data types of the previously mapped parameters.
0x232C:005 (P531.05)	Modbus register assignment: Register 5 (Reg. assigned: Register 5) • Read only	Display of the internal Modbus register number starting from which the parameter mapped in 0x232B:5 is stored. • 2500 + offset. The offset results from the data types of the previously mapped parameters.
0x232C:006 (P531.06)	Modbus register assignment: Register 6 (Reg. assigned: Register 6) • Read only	Display of the internal Modbus register number starting from which the parameter mapped in 0x232B:6 is stored. • 2500 + offset. The offset results from the data types of the previously mapped parameters.
0x232C:007 (P531.07)	Modbus register assignment: Register 7 (Reg. assigned: Register 7) • Read only	Display of the internal Modbus register number starting from which the parameter mapped in 0x232B:7 is stored. • 2500 + offset. The offset results from the data types of the previously mapped parameters.
0x232C:008 (P531.08)	Modbus register assignment: Register 8 (Reg. assigned: Register 8) • Read only	Display of the internal Modbus register number starting from which the parameter mapped in 0x232B:8 is stored. • 2500 + offset. The offset results from the data types of the previously mapped parameters.
0x232C:009 (P531.09)	Modbus register assignment: Register 9 (Reg. assigned: Register 9) • Read only	Display of the internal Modbus register number starting from which the parameter mapped in 0x232B:9 is stored. • 2500 + offset. The offset results from the data types of the previously mapped parameters.
0x232C:010 (P531.10)	Modbus register assignment: Register 10 (Reg. assigned: Register 10) • Read only	Display of the internal Modbus register number starting from which the parameter mapped in 0x232B:10 is stored. • 2500 + offset. The offset results from the data types of the previously mapped parameters.
0x232C:011 (P531.11)	Modbus register assignment: Register 11 (Reg. assigned: Register 11) • Read only	Display of the internal Modbus register number starting from which the parameter mapped in 0x232B:11 is stored. • 2500 + offset. The offset results from the data types of the previously mapped parameters.
0x232C:012 (P531.12)	Modbus register assignment: Register 12 (Reg. assigned: Register 12) • Read only	Display of the internal Modbus register number starting from which the parameter mapped in 0x232B:12 is stored. • 2500 + offset. The offset results from the data types of the previously mapped parameters.
0x232C:013 (P531.13)	Modbus register assignment: Register 13 (Reg. assigned: Register 13) • Read only	Display of the internal Modbus register number starting from which the parameter mapped in 0x232B:13 is stored. • 2500 + offset. The offset results from the data types of the previously mapped parameters.

Configuring the network

Modbus RTU

Modbus RTU data mapping



Parameter	Name / value range / [default setting]	Info
0x232C:014 (P531.14)	Modbus register assignment: Register 14 (Reg. assigned: Register 14) • Read only	Display of the internal Modbus register number starting from which the parameter mapped in 0x232B:14 is stored. • 2500 + offset. The offset results from the data types of the previously mapped parameters.
0x232C:015 (P531.15)	Modbus register assignment: Register 15 (Reg. assigned: Register 15) • Read only	Display of the internal Modbus register number starting from which the parameter mapped in 0x232B:15 is stored. • 2500 + offset. The offset results from the data types of the previously mapped parameters.
0x232C:016 (P531.16)	Modbus register assignment: Register 16 (Reg. assigned: Register 16) • Read only	Display of the internal Modbus register number starting from which the parameter mapped in 0x232B:16 is stored. • 2500 + offset. The offset results from the data types of the previously mapped parameters.
0x232C:017 (P531.17)	Modbus register assignment: Register 17 (Reg. assigned: Register 17) • Read only	Display of the internal Modbus register number starting from which the parameter mapped in 0x232B:17 is stored. • 2500 + offset. The offset results from the data types of the previously mapped parameters.
0x232C:018 (P531.18)	Modbus register assignment: Register 18 (Reg. assigned: Register 18) • Read only	Display of the internal Modbus register number starting from which the parameter mapped in 0x232B:18 is stored. • 2500 + offset. The offset results from the data types of the previously mapped parameters.
0x232C:019 (P531.19)	Modbus register assignment: Register 19 (Reg. assigned: Register 19) • Read only	Display of the internal Modbus register number starting from which the parameter mapped in 0x232B:19 is stored. • 2500 + offset. The offset results from the data types of the previously mapped parameters.
0x232C:020 (P531.20)	Modbus register assignment: Register 20 (Reg. assigned: Register 20) • Read only	Display of the internal Modbus register number starting from which the parameter mapped in 0x232B:20 is stored. • 2500 + offset. The offset results from the data types of the previously mapped parameters.
0x232C:021 (P531.21)	Modbus register assignment: Register 21 (Reg. assigned: Register 21) • Read only	Display of the internal Modbus register number starting from which the parameter mapped in 0x232B:21 is stored. • 2500 + offset. The offset results from the data types of the previously mapped parameters.
0x232C:022 (P531.22)	Modbus register assignment: Register 22 (Reg. assigned: Register 22) • Read only	Display of the internal Modbus register number starting from which the parameter mapped in 0x232B:22 is stored. • 2500 + offset. The offset results from the data types of the previously mapped parameters.
0x232C:023 (P531.23)	Modbus register assignment: Register 23 (Reg. assigned: Register 23) • Read only	Display of the internal Modbus register number starting from which the parameter mapped in 0x232B:23 is stored. • 2500 + offset. The offset results from the data types of the previously mapped parameters.
0x232C:024 (P531.24)	Modbus register assignment: Register 24 (Reg. assigned: Register 24) • Read only	Display of the internal Modbus register number starting from which the parameter mapped in 0x232B:24 is stored. • 2500 + offset. The offset results from the data types of the previously mapped parameters.
0x232D (P532.00)	Modbus verification code (Verificationcode) • Read only	





8.6.9 Modbus RTU LED status displays

Information about the Modbus status can be obtained quickly via the "MOD-RUN" and "MOD-ERR" LED displays on the front of the inverter.

The meaning can be seen from the tables below.

Inverter not active on the Modbus bus (yet)

LED "MOD-RUN"	LED "MOD-ERR"	Meaning
off	 on	Internal error
		Automatic detection of baud rate and data format active.

Inverter active on the Modbus

The green "MOD-RUN" LED indicates the communication status:

LED "MOD-RUN"	Communication status
off	No reception / no transmission
 on	Reception / transmission active

The red "MOD-ERR" LED indicates an error:

LED "MOD-ERR"	Error
off	No fault
 Blinking	Communication error

8.6.10 Reset Modbus RTU interface

The following parameter can be used to restart communication.

Details

A restart of communication is required after changes of the interface configuration (e. g. node address and baud rate) in order that the changed settings become effective.

For restarting communication, there are two options:

- Switch inverter off and on again.
- Set the selection = "Restart with current values [1]" in [0x2320 \(P508.00\)](#).

Parameter	Name / value range / [default setting]	Info
0x2320 (P508.00)	Modbus communication (Modbus comm.)	1 = restart communication in order that changed settings of the interface configuration become effective.
	0 No action/no error	
	1 Restart with current values	

8.6.11 Modbus RTU response time

Parameter	Name / value range / [default setting]	Info
0x2321:004 (P510.04)	Modbus settings: Minimum response time (Modbus sett.: Min. resp. time) 0 ... [0] ... 1000 ms	Minimum time delay between the reception of a valid message and the response of the drive.

Configuring the network



Modbus RTU
Short setup of Modbus RTU



8.6.12 Short setup of Modbus RTU

In the following, the steps required for controlling the inverter via Modbus are described.

Parameterisation required

1. Activate network control: `0x2631:037 (P400.37) = "TRUE [1]"`
2. Set network as standard setpoint source: `0x2860:001 (P201.01) = "Network [5]"`
3. Set Modbus node address.
 - Each network node must be provided with a unique node address.
 - Details: [▶ Modbus RTU node address](#)  255
4. Set Modbus baud rate.
 - Default setting: Automatic detection.
 - If the automatic baud rate detection function is activated, the first 5 ... 10 messages are lost after switch-on.
 - Details: [▶ Modbus RTU baud rate](#)  256
5. Set Modbus data format.
 - Default setting: Automatic detection.
 - If the automatic data format detection function is activated, the first 5 ... 10 messages are lost after switch-on.
 - Details: [▶ Modbus RTU data format](#)  256



In the default setting, the digital input DI1 is assigned with the "Run" function. If the network control is activated, this function serves as "start enable" for start commands via network. Hence, the digital input DI1 must be set to HIGH level in order that the motor can be started via network. [▶ Start / stop motor](#)  499

Starting/stopping the drive via Modbus

For starting/stopping the drive, Modbus register 42101 can be used.

- Modbus register 42101 is permanently assigned to the AC Drive control word `0x400B:001 (P592.01)`.
- In the frame, the leading 4 is omitted in the addressing process. The numbering of the registers starts with 1; addressing, however starts with 0. Therefore the address 2100 (0x0834) is used in the frame when register 42101 is written.

Bits set in the AC drive control word:

- Bit 0 \equiv Run forward (CW)
- Bit 5 \equiv Activate network control
- Bit 6 \equiv Activate network setpoint

Example of an inverter with the node address 1:

Request frame by the master							
Slave address	Function code	Data				Checksum (CRC)	
		Register address		AC Drive control word			
0x01	0x06	0x08	0x34	0x00	0x61	0x0B	0x8C

If digital input DI1 ("Start enable") is set to HIGH level, the drive should start and the inverter should respond with the same frame as confirmation:

Response message from the inverter							
Slave address	Function code	Data				Checksum (CRC)	
		Register address		AC Drive control word			
0x01	0x06	0x08	0x34	0x00	0x61	0x0B	0x8C



8.7 PROFIBUS



PROFIBUS® (Process Field Bus) is a widely-used fieldbus system for the automation of machines and production plants.

- Detailed information on PROFIBUS can be found on the web page of the PROFIBUS & PROFINET International (PI) user organisation: <http://www.profibus.com>
- Information about the dimensioning of a PROFIBUS network can be found in the configuration document for the inverter.
- PROFIBUS® is a registered trademark and patented technology licensed by the PROFIBUS & PROFINET International (PI) user organisation.

Preconditions

- Control unit (CU) of the inverter is provided with PROFIBUS.
- The GSE device description files for PROFIBUS can be found here:
<http://www.lenze.com/application-knowledge-base/artikel/200412329/0/>

8.7.1 PROFIBUS introduction

The inverter is integrated into a PROFIBUS-DP network as slave. Therefore it is only allowed to receive and acknowledge messages and to respond to requests by a master. The master is also referred to as an active node. Two different types are distinguished:

- Class 1 DP master: central control (PLC or PC) which cyclically exchanges process data with the slave. Acyclic data exchange via a separate transmission channel is also possible.
- Class 2 DP master: engineering, configuration, or operator device (HMI) which only exchanges data with the slave acyclically, e.g. for the purposes of configuration, maintenance, or diagnostics.

8.7.2 PROFIBUS communication time

The communication time is the time between the start of a request and the arrival of the corresponding response.

The communication times in the PROFIBUS network depend on the ...

- processing time in the inverter
- Telegram runtime (baud rate/telegram length),
- nesting depth of the network.

In the case of the inverter, the processing time for process data is approx. 2 ... 3 ms, and for parameter data (DPV1) it is approx. 10 ms. There are no interdependencies between parameter data and process data.

Configuring the network

PROFIBUS
PROFIBUS station address



8.7.3 PROFIBUS station address

Each network node must be provided with a unique station address.

Details

- The station address of the inverter can be optionally set via the DIP switches on the device labelled with "1" ... "64" or in [0x2341:001 \(P510.01\)](#). (The DIP switches have priority.)
- The setting that is active when the inverter is switched on is the effective setting.
- The labelling of the DIP switches corresponds to the values of the individual DIP switches for determining the station address (see the following example).
- The active station address is shown in [0x2342:001 \(P511.01\)](#).

Example of how the station address is set via the DIP switches

DIP switch	64	32	16	8	4	2	1
Setting	OFF	OFF	ON	OFF	ON	ON	ON
Value	0	0	16	0	4	2	1
Station address	= sum of all values = 16 + 4 + 2 + 1 = 23						

Parameter	Name / value range / [default setting]	Info
0x2341:001 (P510.01)	PROFIBUS settings: Station address (PROFIBUS sett.: Station address) 1 ... [3] ... 125	Optional setting of the station address (instead of setting via DIP switches 1 ... 64). <ul style="list-style-type: none"> • The station address set here only becomes effective if DIP switches 1 ... 64 have been set to OFF before mains switching. • A change in the station address only becomes effective after a restart of PROFIBUS communication.
0x2342:001 (P511.01)	Active PROFIBUS settings: Active station address (PROFIBUS diag.: Act.station addr) <ul style="list-style-type: none"> • Read only 	Display of the active station address.
0x2343 (P509.00)	PROFIBUS switch position (PROFIBUS switch) <ul style="list-style-type: none"> • Read only 	Display of the DIP switch setting at the last mains power-on. <ul style="list-style-type: none"> • The displayed value corresponds to the sum of the individual DIP switch values 1 ... 64.

8.7.4 PROFIBUS baud rate

At the class 1 DP master, the desired baud rate is set. All masters at the bus must be set to the same baud rate.

Details

- The inverter detects the baud rate automatically.
- The active baud rate is displayed in [0x2342:002 \(P511.02\)](#).
- The status of automatic detection is displayed in [0x2348:002 \(P516.02\)](#).

Parameter	Name / value range / [default setting]	Info
0x2342:002 (P511.02)	Active PROFIBUS settings: Active baud rate (PROFIBUS diag.: Active baud rate) <ul style="list-style-type: none"> • Read only 	Display of the active baud rate.
	0 12 Mbps	
	1 6 Mbps	
	2 3 Mbps	
	3 1.5 Mbps	
	4 500 kbps	
	5 187.5 kbps	
	6 93.75 kbps	
	7 45.45 kbps	
	8 19.2 kbps	
	9 9.6 kbps	
	15 Search	Automatic baud rate detection active.



Parameter	Name / value range / [default setting]	Info
0x2348:002 (P516.02)	PROFIBUS Status: Watchdog status (PROFIBUS Status: Watchdog status) • Read only	Display of the current state of the watchdog state machine (WD-STATE).
	0 BAUD_SEARCH	The inverter (slave) is able to detect the baud rate automatically.
	1 BAUD_CONTROL	After detecting the correct baud rate, the inverter (slave) status changes to BAUD_CONTROL, and the baud rate is monitored.
	2 DP_CONTROL	The DP_CONTROL state serves to the response monitoring of the master.

8.7.5 PROFIBUS monitoring

The inverter can give a parameterisable response to various PROFIBUS errors.

Details

The following table lists the PROFIBUS errors that can be set for a response.

Event	Display in	Response can be set in	Default setting
Communication to the PROFIBUS master is continuously interrupted.	0x2349 (P517.00), Bit 0	0x2859:001 (P515.01)	Error
Data exchange via PROFIBUS has been terminated.	0x2349 (P517.00), Bit 1	0x2859:002 (P515.02)	No response
The inverter has received invalid configuration data from the master.	0x2349 (P517.00), Bit 2	0x2859:003 (P515.03)	Error
An error has occurred during the initialisation of the PROFIBUS interface.	0x2349 (P517.00), Bit 3	0x2859:004 (P515.04)	Error
The process data received are invalid.	0x2349 (P517.00), Bit 4	0x2859:005 (P515.05)	Trouble

Parameter	Name / value range / [default setting]	Info
0x2342:003 (P511.03)	Active PROFIBUS settings: Watchdog time (PROFIBUS diag.: Watchdog time) • Read only	Display of the watchdog monitoring time specified by the master. • Monitoring starts with the arrival of the first telegram. • When a value of "0" is displayed, the monitoring function is deactivated. • A change in the watchdog monitoring time in the master is effective immediately.
0x2348:002 (P516.02)	PROFIBUS Status: Watchdog status (PROFIBUS Status: Watchdog status) • Read only	Display of the current state of the watchdog state machine (WD-STATE).
	0 BAUD_SEARCH	The inverter (slave) is able to detect the baud rate automatically.
	1 BAUD_CONTROL	After detecting the correct baud rate, the inverter (slave) status changes to BAUD_CONTROL, and the baud rate is monitored.
	2 DP_CONTROL	The DP_CONTROL state serves to the response monitoring of the master.

Configuring the network

PROFIBUS
PROFIBUS monitoring





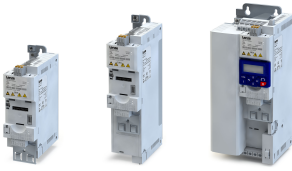



Parameter	Name / value range / [default setting]	Info
0x2349 (P517.00)	PROFIBUS error (PROFIBUS error) • Read only	Bit-coded display of PROFIBUS errors.
	Bit 0 Watchdog elapsed	Communication with the PROFIBUS master is continuously interrupted, e. g. by cable break or failure of the PROFIBUS master. • No process data are sent to the inverter (slave) in the "Data Exchange" state. • When the watchdog monitoring time specified by the master has elapsed, the response set in 0x2859:001 (P515.01) is triggered in the inverter. Preconditions for a response by the inverter (slave): • The slave is in the "Data Exchange" state. • The watchdog monitoring time is configured correctly in the master (1 ... 65535 ms). If one of these preconditions is not met, the response to the absence of cyclic process data telegrams from the master is not executed.
	Bit 1 Data exchange completed	Data exchange via PROFIBUS has been terminated. • The inverter (slave) can be instructed by the master to exit the "Data Exchange" state. • If this state change is to be treated as an error in the inverter, the desired response can be set in 0x2859:002 (P515.02) .
	Bit 2 Incorrect configuration data	The inverter (slave) has received invalid configuration data from the master. • The response set in 0x2859:003 (P515.03) is effected.
	Bit 3 Initialisation error	An error has occurred during the initialisation of the PROFIBUS interface. • The response set in 0x2859:004 (P515.04) is effected.
Bit 4 Invalid process data	The inverter (slave) has received invalid process data from the master, e.g. no process data or deleted process data are sent by the "Stop" operating status in the master. • The response set in 0x2859:005 (P515.05) is effected.	
0x2859:001 (P515.01)	PROFIBUS monitoring: Watchdog elapsed (PROFIBUS monit.: WD elapsed) • For further possible settings, see parameter 0x2D45:001 (P310.01) . □ 196	Selection of the response to the continuous interruption of communication to the PROFIBUS master, e. g. by cable break or failure of the PROFIBUS master. Associated error code: • 33168 0x8190 - Network: watchdog timeout
	3 Fault	▶ Error types □ 113
0x2859:002 (P515.02)	PROFIBUS monitoring: Data exchange completed (PROFIBUS monit.: Data exch.exited) • For further possible settings, see parameter 0x2D45:001 (P310.01) . □ 196	Selection of the response to exiting the "Data Exchange" state. Associated error code: • 33169 0x8191 - Network: disruption of cyclic data exchange
	0 No response	▶ Error types □ 113
0x2859:003 (P515.03)	PROFIBUS monitoring: Invalid configuration (PROFIBUS monit.: Invalid config) • For further possible settings, see parameter 0x2D45:001 (P310.01) . □ 196	Selection of the response triggered by the reception of invalid configuration data. Associated error code: • 33414 0x8286 - Network: PDO mapping error
	3 Fault	▶ Error types □ 113
0x2859:004 (P515.04)	PROFIBUS monitoring: Initialisation error (PROFIBUS monit.: Init. error) • For further possible settings, see parameter 0x2D45:001 (P310.01) . □ 196	Selection of the response triggered by the occurrence of an error during the initialisation of the PROFIBUS module. Associated error code: • 33170 0x8192 - Network: initialisation error
	3 Fault	▶ Error types □ 113
0x2859:005 (P515.05)	PROFIBUS monitoring: Invalid process data (PROFIBUS monit.: Inval. proc.data) • For further possible settings, see parameter 0x2D45:001 (P310.01) . □ 196	Selection of the response triggered by the reception of invalid process data. • If the master changes to the "Stop" state, no cyclic process data are sent to the inverter (slave) anymore; the length of the process data then is 0. Associated error code: • 33171 0x8193 - Network: invalid cyclic process data
	2 Trouble	▶ Error types □ 113



8.7.6 PROFIBUS LED status displays

Information about the PROFIBUS status can be obtained quickly via the "NS" and "NE" LED displays on the front of the inverter.

The meaning can be seen from the table below.

LED "NS" (green)	LED "NE" (red)	Status/meaning
off	off	No supply voltage available, network deactivated, not initialised, or firmware download active.
 on		Connected with master, control running, "Data Exchange" state active.
 Blinking		Not connected, control stopped, or no data exchange.
 Blinking	 Blinking	Watchdog monitoring time elapsed.
Any	 Flashing	PROFIBUS parameterisation error.
	 Flashing 2 x	PROFIBUS configuration error.
off	 on	Invalid station address set or non-correctable error.

8.7.7 PROFIBUS diagnostics

The following parameters serve to diagnose the communication activities between the inverter and the PROFIBUS network.

Parameter	Name / value range / [default setting]	Info
0x2344:001 (P512.01)	PROFIBUS Configuration: Extended diagnostic bit (PROFIBUS Config.: Ext. diag. bit) 0 Delete 1 Set	1 = set external diagnostic bit ("Diag Bit"). • The diagnostic bit is sent to the master where it is evaluated separately.
0x2348:001 (P516.01)	PROFIBUS Status: Bus status (PROFIBUS Status: Bus status) • Read only 0 WAIT_PRM 1 WAIT_CFG 2 DATA_EXCH	Display of the current DP state machine state (DP-STATE). After the run-up, the inverter (slave) is waiting for parameter data (CHK_PRM) from the master. All other frame types are not processed. Exchanging user data with the master is not possible yet. The inverter (slave) is waiting for configuration data (CHK_CFG) from the master that define the structure of the cyclic frames. Parameter and configuration data have been received and accepted by the inverter (slave). The inverter is in the "Data Exchange" state. It is now possible to exchange user data with the master.
0x234A:001 (P580.01)	PROFIBUS statistics: Data cycles per second (PROFIBUS counter: Data cycles/sec.) • Read only	Display of the data cycles per second.
0x234A:002 (P580.02)	PROFIBUS statistics: Parameterization events (PROFIBUS counter: PRM events) • Read only	Display of the number of parameterisation events.
0x234A:003 (P580.03)	PROFIBUS statistics: Configuration events (PROFIBUS counter: CFG events) • Read only	Display of the number of configuration events.
0x234A:004 (P580.04)	PROFIBUS statistics: Diagnostics events (PROFIBUS counter: DIAG events) • Read only	Display of the number of diagnostic telegrams sent.
0x234A:005 (P580.05)	PROFIBUS statistics: C1 messages (PROFIBUS counter: C1 messages) • Read only	Display of the number of requests by the class 1 DPV1 master.
0x234A:006 (P580.06)	PROFIBUS statistics: C2 messages (PROFIBUS counter: C2 messages) • Read only	Display of the number of requests by the class 2 DPV1 master.
0x234A:007 (P580.07)	PROFIBUS statistics: Watchdog events (PROFIBUS counter: WD events) • Read only	Display of the number of watchdog events.

Configuring the network

PROFIBUS
PROFIBUS functions



Parameter	Name / value range / [default setting]	Info
0x234A:008 (P580.08)	PROFIBUS statistics: Data exchange aborts (PROFIBUS counter: DataEx.event) • Read only	Display of the number of "Data Exchange exited" events.
0x234A:009 (P580.09)	PROFIBUS statistics: Total data cycles (PROFIBUS counter: Tot. data cycles) • Read only	Display of the number of cyclic process data received.
0x2348:002 (P516.02)	PROFIBUS Status: Watchdog status (PROFIBUS Status: Watchdog status) • Read only	Display of the current state of the watchdog state machine (WD-STATE).
	0 BAUD_SEARCH	The inverter (slave) is able to detect the baud rate automatically.
	1 BAUD_CONTROL	After detecting the correct baud rate, the inverter (slave) status changes to BAUD_CONTROL, and the baud rate is monitored.
	2 DP_CONTROL	The DP_CONTROL state serves to the response monitoring of the master.

8.7.8 PROFIBUS functions

The inverter supports PROFIBUS DP-V0 (DRIVECOM profile) and PROFIBUS DP-V1 (PROFIdrive profile). PROFIBUS DP-V2 is not supported.

Details

The PROFIBUS DP communication protocol is provided with the following functions:

- DP-V0: cyclic data exchange, diagnostics (all devices).
- DP-V1: acyclic data exchange, process alarm processing (process automation). Note: The inverter does not support any alarm diagnostics.
- DP-V2: cycle synchronisation and time stamp, slave-to-slave communication.

A class 1 DP master connection (DPV1 C1) between a cyclic master and slave is established automatically when the "Data Exchange" state has been established. In byte 7 of the parameterisation frame, the "DPV1_Enable" bit must be set. Furthermore, a class 2 DP master connection (DPV1 C2) with the slave can be defined by another master connected. This connection must be established via the "MSAC2_Initiate" service.

The inverter supports the following acyclic DPV1 services:

- MSAC1_Read/Write: C1 read/write request for a data block.
- MSAC2_Initiate/Abort: connection or disconnection for acyclic data exchange between a class 2 DP master and the slave.
- MSAC2_Read/Write: C2 read/write request for a data block.



8.7.9 PROFIBUS data mapping

Data mapping is used to define which process data are exchanged cyclically between the master and slave. Data mapping is defined in the hardware configurator. The configuration of the process data is automatically sent to the inverter. The same applies to the bit configuration of the data words NetWordIN1 and NetWordOUT1.

Details

- First the user imports the GSD file into the hardware configurator of the control. By adding the node to the PROFIBUS network configuration, the user can then select the data required for the application.
- After the start-up, the master communicates the structure of the cyclic frames to the inverter (slave) via the configuration frame (CHK_CFG).
- The inverter checks the configuration. If the configuration is accepted, the inverter changes from the "Wait Configuration" state to the "Data Exchange" state. It is now possible to exchange user data with the master.
- The internal mapping of the cyclic data is set in 0x24E0:xxx (master → inverter direction) and 0x24E1:xxx (inverter → master direction).
Format: 0xiiiissll (iiii = index hexadecimal, ss = subindex hexadecimal, ll = data length hexadecimal)

Parameter	Name / value range / [default setting]	Info
0x24E0:000	Generic RPDO mapping: Highest subindex 0 ... [2] ... 16 • From version 02.00	Number of mapping entries for RPDO.
0x24E0:001	Generic RPDO mapping: Entry 1 0x00000000 ... [0x60400010] ... 0xFFFFFFFF • From version 02.00	Mapping entry 1 for RPDO.
0x24E0:002	Generic RPDO mapping: Entry 2 0x00000000 ... [0x60420010] ... 0xFFFFFFFF • From version 02.00	Mapping entry 2 for RPDO.
0x24E0:003	Generic RPDO mapping: Entry 3 0x00000000 ... [0x00000000] ... 0xFFFFFFFF • From version 02.00	Mapping entry 3 for RPDO.
0x24E0:004	Generic RPDO mapping: Entry 4 0x00000000 ... [0x00000000] ... 0xFFFFFFFF • From version 02.00	Mapping entry 4 for RPDO.
0x24E0:005	Generic RPDO mapping: Entry 5 0x00000000 ... [0x00000000] ... 0xFFFFFFFF • From version 02.00	Mapping entry 5 for RPDO.
0x24E0:006	Generic RPDO mapping: Entry 6 0x00000000 ... [0x00000000] ... 0xFFFFFFFF • From version 02.00	Mapping entry 6 for RPDO.
0x24E0:007	Generic RPDO mapping: Entry 7 0x00000000 ... [0x00000000] ... 0xFFFFFFFF • From version 02.00	Mapping entry 7 for RPDO.
0x24E0:008	Generic RPDO mapping: Entry 8 0x00000000 ... [0x00000000] ... 0xFFFFFFFF • From version 02.00	Mapping entry 8 for RPDO.
0x24E0:009	Generic RPDO mapping: Entry 9 0x00000000 ... [0x00000000] ... 0xFFFFFFFF • From version 02.00	Mapping entry 9 for RPDO.
0x24E0:010	Generic RPDO mapping: Entry 10 0x00000000 ... [0x00000000] ... 0xFFFFFFFF • From version 02.00	Mapping entry 10 for RPDO.
0x24E0:011	Generic RPDO mapping: Entry 11 0x00000000 ... [0x00000000] ... 0xFFFFFFFF • From version 02.00	Mapping entry 11 for RPDO.
0x24E0:012	Generic RPDO mapping: Entry 12 0x00000000 ... [0x00000000] ... 0xFFFFFFFF • From version 02.00	Mapping entry 12 for RPDO.

Configuring the network

PROFIBUS

PROFIBUS data mapping

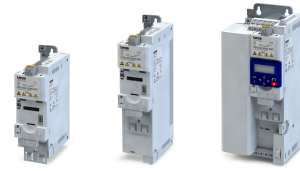

Parameter	Name / value range / [default setting]	Info
0x24E0:013	Generic RPDO mapping: Entry 13 0x00000000 ... [0x00000000] ... 0xFFFFFFFF • From version 02.00	Mapping entry 13 for RPDO.
0x24E0:014	Generic RPDO mapping: Entry 14 0x00000000 ... [0x00000000] ... 0xFFFFFFFF • From version 02.00	Mapping entry 14 for RPDO.
0x24E0:015	Generic RPDO mapping: Entry 15 0x00000000 ... [0x00000000] ... 0xFFFFFFFF • From version 02.00	Mapping entry 15 for RPDO.
0x24E0:016	Generic RPDO mapping: Entry 16 0x00000000 ... [0x00000000] ... 0xFFFFFFFF • From version 02.00	Mapping entry 16 for RPDO.
0x24E1:000	Generic TPDO mapping: Highest subindex 0 ... [3] ... 16 • From version 02.00	Number of mapping entries for TPDO.
0x24E1:001	Generic TPDO mapping: Entry 1 0x00000000 ... [0x60410010] ... 0xFFFFFFFF • From version 02.00	Mapping entry 1 for TPDO.
0x24E1:002	Generic TPDO mapping: Entry 2 0x00000000 ... [0x60440010] ... 0xFFFFFFFF • From version 02.00	Mapping entry 2 for TPDO.
0x24E1:003	Generic TPDO mapping: Entry 3 0x00000000 ... [0x603F0010] ... 0xFFFFFFFF • From version 02.00	Mapping entry 3 for TPDO.
0x24E1:004	Generic TPDO mapping: Entry 4 0x00000000 ... [0x00000000] ... 0xFFFFFFFF • From version 02.00	Mapping entry 4 for TPDO.
0x24E1:005	Generic TPDO mapping: Entry 5 0x00000000 ... [0x00000000] ... 0xFFFFFFFF • From version 02.00	Mapping entry 5 for TPDO.
0x24E1:006	Generic TPDO mapping: Entry 6 0x00000000 ... [0x00000000] ... 0xFFFFFFFF • From version 02.00	Mapping entry 6 for TPDO.
0x24E1:007	Generic TPDO mapping: Entry 7 0x00000000 ... [0x00000000] ... 0xFFFFFFFF • From version 02.00	Mapping entry 7 for TPDO.
0x24E1:008	Generic TPDO mapping: Entry 8 0x00000000 ... [0x00000000] ... 0xFFFFFFFF • From version 02.00	Mapping entry 8 for TPDO.
0x24E1:009	Generic TPDO mapping: Entry 9 0x00000000 ... [0x00000000] ... 0xFFFFFFFF • From version 02.00	Mapping entry 9 for TPDO.
0x24E1:010	Generic TPDO mapping: Entry 10 0x00000000 ... [0x00000000] ... 0xFFFFFFFF • From version 02.00	Mapping entry 10 for TPDO.
0x24E1:011	Generic TPDO mapping: Entry 11 0x00000000 ... [0x00000000] ... 0xFFFFFFFF • From version 02.00	Mapping entry 11 for TPDO.
0x24E1:012	Generic TPDO mapping: Entry 12 0x00000000 ... [0x00000000] ... 0xFFFFFFFF • From version 02.00	Mapping entry 12 for TPDO.
0x24E1:013	Generic TPDO mapping: Entry 13 0x00000000 ... [0x00000000] ... 0xFFFFFFFF • From version 02.00	Mapping entry 13 for TPDO.
0x24E1:014	Generic TPDO mapping: Entry 14 0x00000000 ... [0x00000000] ... 0xFFFFFFFF • From version 02.00	Mapping entry 14 for TPDO.
0x24E1:015	Generic TPDO mapping: Entry 15 0x00000000 ... [0x00000000] ... 0xFFFFFFFF • From version 02.00	Mapping entry 15 for TPDO.
0x24E1:016	Generic TPDO mapping: Entry 16 0x00000000 ... [0x00000000] ... 0xFFFFFFFF • From version 02.00	Mapping entry 16 for TPDO.



8.7.10 PROFIBUS - acyclic data transfer

Data communication with PROFIBUS DP-V0 is characterised by cyclic diagnostics and cyclic process data transfer. An optional service expansion is the acyclic parameter data transfer of PROFIBUS DP-V1. This service does not impair the functionality of the standard services under PROFIBUS DP-V0.

Details

- PROFIBUS DP-V0 and PROFIBUS DP-V1 can be operated simultaneously in the same network. This enables the step-by-step expansion or modification of a system.
- The services of PROFIBUS DP-V1 can be used by the class 1 master (PLC) and the class 2 DP master (diagnostics master, etc.).
- Integration of the acyclic service into the fixed bus cycle depends on the corresponding configuration of the class 1 master:
 - With configuration, a time slot is reserved.
 - Without configuration, the acyclic service is appended when a class 2 DP master acyclically accesses a DP-V1 slave.

Product features

- 16 bits each for addressing the parameter index and subindex.
- Several parameter requests can be combined to one request (multi-parameter requests).
- Only one request is processed at a time (no pipelining).
- A request or response must fit into one data block (max. 240 bytes). Requests or responses cannot be split into several data blocks.
- No spontaneous messages are transferred.
- There are only acyclic parameter requests.
- Profile-specific parameters can be read independently of the slave state.
- A class 1 DP master can always request parameters from a slave if the slave is in the "Data Exchange" state.
- In addition to a class 1 DP master, a class 2 DP master can establish communication with a slave:

Transmission directions for acyclic data transfer

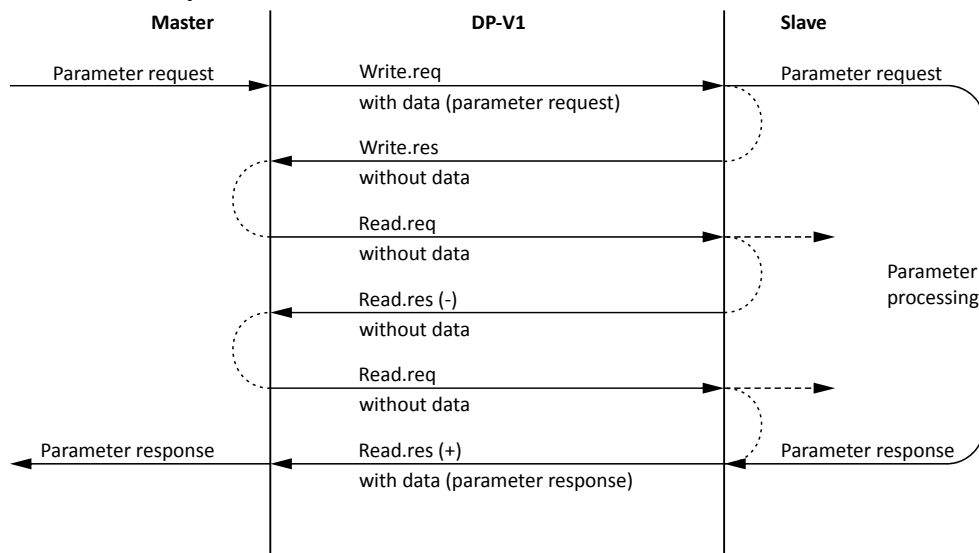

Procedure:

1. A "Write.req" is used to pass the data set (DB47) to the slave in the form of a parameter request.
2. With "Write.res" the master receives the confirmation for the receipt of the message.
3. The master requests the response of the slave with "Read.req".
4. The slave responds with "Read.res (-)" if processing has not been completed yet.
5. After parameter processing, the parameter request is completed by transmitting the parameter response to the master with "Read.res (+)".

Configuring the network

PROFIBUS

PROFIBUS - acyclic data transfer



Telegram structure

SD	LE	LEr	SD	DA	SA	FC	DSAP	SSAP	Data Unit (DU)	FCS	ED
----	----	-----	----	----	----	----	------	------	-----------------------	-----	----

The Data Unit (DU) contains the DP-V1 header and the parameter request or the parameter response. The DP V1 header consists of the function detection, slot number, data set, and the length of the user data. More information about the DP-V1 header can be found in the corresponding PROFIBUS specification. A detailed description of the parameter request and parameter response can be found in the following subchapters.

Assignment of the user data depending on the data type

Depending on the data type used, the user data are assigned as follows:

Data type	Length	User data assignment				
		Byte 1	Byte 2	Byte 3	Byte 4	Byte ...
String	x bytes	<i>Data (x bytes)</i>				
U8	1 byte	<i>Data</i>	0x00			
U16	2 bytes	HIGH byte	LOW byte			
		<i>Data</i>	<i>Data</i>			
U32	4 bytes	HIGH word		LOW word		
		HIGH byte	LOW byte	HIGH byte	LOW byte	
		<i>Data</i>	<i>Data</i>	<i>Data</i>	<i>Data</i>	



8.7.11 PROFIBUS - reading parameter data acyclically

This section describes the request and response for the acyclic reading of a parameter.

Details

- When a read request is processed, no parameter value is written to the slave.
- When a read request is transmitted by multi-parameters, the parameter attribute, index and subindex are repeated.
- A read request must not exceed the maximum data length of 240 bytes.

Request header

Byte 1	Byte 2	Byte 3	Byte 4
Request reference	Request identification	Axis	Number of indices

Field	Data type	Values
Request reference	U8	This value is defined by the master.
Request identification	U8	0x01: Request parameters for reading.
Axis	U8	0x00 or 0x01
Number of indices	U8	0x"n" (n = number of parameters requested)

Parameter attribute

Byte 5	Byte 6
Attribute	Number of subindices

Field	Data type	Values
Attribute	U8	0x10: Value
Number of subindices	U8	0x00

Index and subindex

Byte 7	Byte 8	Byte 9	Byte 10
Index		Subindex	
HIGH byte	LOW byte	HIGH byte	LOW byte

Field	Data type	Values
Index	U16	0x0001 ... 0xFFFF (1 ... 65535)
Subindex	U16	0x0000 ... 0x00FF (0 ... 255)

Response to a correctly executed read request

Responses to a read request do not contain parameter attributes, indices and subindices.

Response header

Byte 1	Byte 2	Byte 3	Byte 4
Request reference (mirrored)	Response identification	Axis (mirrored)	Number of indices

Field	Data type	Values
Request reference	U8	Mirrored value of the parameter request.
Response identification	U8	0x01: Parameter has been read.
Axis	U8	0x00 or 0x01
Number of indices	U8	0x"n" (n = number of parameters requested)

Configuring the network

PROFIBUS

PROFIBUS - reading parameter data acyclically



Parameter format

Byte 5	Byte 6	
Format	Number of values	

Field	Data type	Values
Format	U8	0x02: integer8 (1 byte with sign) 0x03: Integer16 (2 bytes with sign) 0x04: Integer32 (4 bytes with sign) 0x05: Unsigned8 (1 byte without sign) 0x06: Unsigned16 (2 bytes without sign) 0x07: Unsigned32 (4 bytes without sign) 0x09: Visible String (with n characters) 0x0A: Octet String (with n characters) 0x40: Zero 0x41: Byte 0x42: Word 0x43: Double word
Number of values	U8	0x01 or number of characters (n) for string parameters.

Parameter value

Byte 7	Byte 8	Byte 9	Byte 10
Value (Integer8 / Unsigned8 / byte)			
	Value (Integer16 / Unsigned16 / word)		
		Value (Integer32 / Unsigned32 / double word)	

Byte 7	Byte 8	Byte 9	Byte ...
			String (Visible String / octet string with an optional length)

Field	Data type	Values
Value	U8/U16/U32	Value range/length depends on the parameter format (see table above).
String	U8	Visible string / octet string with an optional length (n characters = n bytes)

Response to a read error

In the case of a multi-parameter request, correct and possible faulty messages are summarised in one telegram. They have the following data contents:

Correct message

- Format: data type of the value requested
- Number of values: as described above.
- Parameter value: value requested

Faulty message

- Format: 0x44
- Number of values: 0x01 or 0x02
- Error code without additional information (for number of values = 0x01) or error code with additional information (for number of values = 0x02)

A faulty access to a parameter "n" is indicated at the nth position in the response telegram of a multi-parameter request.



Response header

Byte 1	Byte 2	Byte 3	Byte 4
Request reference (mirrored)	Response identification	Axis (mirrored)	Number of indices

Field	Data type	Values
Request reference	U8	Mirrored value of the parameter request.
Response identification	U8	0x81: Parameter has not been read. The data in bytes 7 + 8 must be interpreted as an error code.
Axis	U8	0x00 or 0x01
Number of indices	U8	0x"n" (n = number of parameters requested)

Parameter format

Byte 5	Byte 6
Format	Number of values

Field	Data type	Values
Format	U8	0x44: Error
Number of values	U8	0x01: Error code without additional information. 0x02: Error code with additional information.

Error code

Byte 7	Byte 8	Byte 9	Byte 10
Error code		Additional information (if available)	
HIGH byte	LOW byte	HIGH byte	LOW byte

Field	Data type	Values
Error code	U16	0x0000 ... 0xFFFF
Additional information (if available)	U16	PROFIBUS error codes for acyclic data transfer 283

Configuring the network

PROFIBUS

PROFIBUS - writing parameter data acyclically



8.7.12 PROFIBUS - writing parameter data acyclically

This section describes the request and response for the acyclic writing of a parameter.

Details

- When a multi-parameter write request is transmitted, the parameter attribute, index and subindex and then the parameter format and parameter value are repeated "n" times, "n" being the number of parameters addressed.
- A write request must not exceed the maximum data length of 240 bytes.

Request header

Byte 1	Byte 2	Byte 3	Byte 4
Request reference	Request identification	Axis	Number of indices

Field	Data type	Values
Request reference	U8	This value is defined by the master.
Request identification	U8	0x02: Write parameters.
Axis	U8	0x00 or 0x01
Number of indices	U8	0x"n" (n = number of parameters addressed)

Parameter attribute

Byte 5	Byte 6
Attribute	Number of subindices

Field	Data type	Values
Attribute	U8	0x10: Value
Number of subindices	U8	0x00

Index and subindex

Byte 7	Byte 8	Byte 9	Byte 10
Index		Subindex	
HIGH byte	LOW byte	HIGH byte	LOW byte

Field	Data type	Values
Index	U16	0x0001 ... 0xFFFF (1 ... 65535)
Subindex	U16	0x0000 ... 0x00FF (0 ... 255)

Parameter format

Byte 11	Byte 12
Format	Number of values

Field	Data type	Values
Format	U8	0x02: integer8 (1 byte with sign) 0x03: Integer16 (2 bytes with sign) 0x04: Integer32 (4 bytes with sign) 0x05: Unsigned8 (1 byte without sign) 0x06: Unsigned16 (2 bytes without sign) 0x07: Unsigned32 (4 bytes without sign) 0x09: Visible String (with n characters) 0x0A: Octet String (with n characters) 0x40: Zero 0x41: Byte 0x42: Word 0x43: Double word
Number of values	U8	0x01 or number of characters (n) for string parameters.

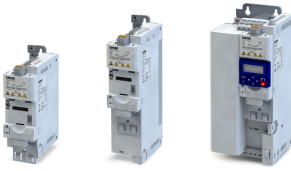

Parameter value

Byte 13	Byte 14	Byte 15	Byte 16
Value (Integer8 / Unsigned8 / byte)			
Value (Integer16 / Unsigned16 / word)			
Value (Integer32 / Unsigned32 / double word)			
Byte 13	Byte 14	Byte 15	Byte ...
String (Visible string / octet string with an optional length)			
Field	Data type	Values	
Value	U8/U16/U32	Value range/length depends on the parameter format (see table above).	
String	U8	Visible string / octet string with an optional length (n characters = n bytes)	

Response to a correctly executed write request

With an error-free multi-parameter request, only the response header is transmitted, and the complete data area is omitted.

Response header

Byte 1	Byte 2	Byte 3	Byte 4
Request reference (mirrored)	Response identification	Axis (mirrored)	Number of indices
Field	Data type	Values	
Request reference	U8	Mirrored value of the parameter request.	
Response identification	U8	0x02: Parameter has been written.	
Axis	U8	0x00 or 0x01	
Number of indices	U8	0x"n" (n = number of parameters addressed)	

Response to a write error

In the case of a multi-parameter request, correct and possible faulty messages are summarised in one telegram. They have the following data contents:

Correct message

- Format: 0x40
- Number of values: 0x00

Faulty message

- Format: 0x44
- Number of values: 0x01 or 0x02
- Error code without additional information (for number of values = 0x01) or error code with additional information (for number of values = 0x02)

A faulty access to a parameter "n" is indicated at the nth position in the response telegram of a multi-parameter request.

Response header

Byte 1	Byte 2	Byte 3	Byte 4
Request reference (mirrored)	Response identification	Axis (mirrored)	Number of indices
Field	Data type	Values	
Request reference	U8	Mirrored value of the parameter request.	
Response identification	U8	0x82: Parameter has not been written. The data in bytes 7 + 8 must be interpreted as an error code.	
Axis	U8	0x00 or 0x01	
Number of indices	U8	0x"n" (n = number of parameters addressed)	

Configuring the network

PROFIBUS

PROFIBUS - writing parameter data acyclically



Parameter format

Byte 5	Byte 6	
Format	Number of values	

Field	Data type	Values
Format	U8	0x44: Error
Number of values	U8	0x01: Error code without additional information. 0x02: Error code with additional information.

Error code

Byte 7	Byte 8	Byte 9	Byte 10
Error code		Additional information (if available)	
HIGH byte	LOW byte	HIGH byte	LOW byte

Field	Data type	Values
Error code	U16	0x0000 ... 0xFFFF
Additional information (if available)	U16	PROFIBUS error codes for acyclic data transfer 283



8.7.13 PROFIBUS error codes for acyclic data transfer

The following table lists all possible error codes for the acyclic data exchange:

Error code	Description	Explanation	Additional information
0x0000	Parameter number impermissible	Access to non-available parameter.	-
0x0001	Parameter value cannot be changed	Change access to a parameter value that cannot be changed.	Subindex
0x0002	Lower or upper value limit exceeded	Change access with value beyond the value limits.	Subindex
0x0003	Subindex impermissible	Access to non-available subindex.	Subindex
0x0004	No array	Access with subindex to non-indicated parameter.	-
0x0005	Incorrect data type	Change access with value that does not match the data type of the parameter.	-
0x0006	No setting permitted (only resettable)	Change access with a non-zero value where it is not permitted.	Subindex
0x0007	Description element cannot be changed	Change access to a description element that cannot be changed.	Subindex
0x0008	Reserved	(PROFIdrive profile V2: PPO-Write requested in IR is not available.)	-
0x0009	Description data not available	Access to non-available description (parameter value is available).	-
0x000A	Reserved	(PROFIdrive profile V2: Wrong access group.)	-
0x000B	No parameter change rights	Change access with missing parameter change rights.	-
0x000C	Reserved	(PROFIdrive profile V2: Wrong password.)	-
0x000D	Reserved	(PROFIdrive profile V2: Text cannot be read in cyclic data transfer.)	-
0x000E	Reserved	(PROFIdrive profile V2: Name cannot be read in cyclic data transfer.)	-
0x000F	No text array available	Access to non-available text array (parameter value is available).	-
0x0010	Reserved	(PROFIdrive profile V2: No PPO-Write.)	-
0x0011	Request cannot be executed due to the operating state	Access is not possible for temporary reasons that are not specified in detail.	-
0x0012	Reserved	(PROFIdrive profile V2: Other error.)	-
0x0013	Reserved	(PROFIdrive profile V2: Date cannot be read in cyclic data transfer.)	-
0x0014	Value impermissible	Change access with the value that is within the value limits but that is impermissible for other permanent reasons (parameters with defined individual values).	Subindex
0x0015	Response too long	The length of the current response exceeds the maximum length transferrable.	-
0x0016	Parameter address impermissible	Impermissible value or value which is not supported for the attribute, number of subindexes, parameter number, or subindex, or a combination.	-
0x0017	Format impermissible	Write request: Impermissible or non-supported format of parameter data.	-
0x0018	Number of values not consistent	Write request: Number of parameter data values does not match the number of subindexes in the parameter address.	-
0x0019	Axis impermissible	Access to non-available axis. For double axis, only 0x00 or 0x01 permitted.	-
0x001A	Reserved	-	-
...			
0x00FF			

Configuring the network

PROFIBUS

Resetting the PROFIBUS interface

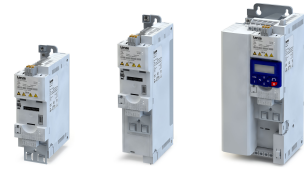

8.7.14 Resetting the PROFIBUS interface

The following parameter can be used to restart or stop communication. Optionally it is also possible to reset all communication parameters to the default status.

Details

A restart of communication is required after changes of the interface configuration (e. g. station address and baud rate) in order that the changed settings become effective.

For restarting communication, there are two options:

- a) Switch inverter off and on again.
- b) Set the selection = "Restart with current values [1]" in [0x2340](#).

Parameter	Name / value range / [default setting]	Info
0x2340	PROFIBUS communication • From version 03.00	Restart / stop communication.
	0 No action/no error	Only status feedback
	1 Restart with current values	Restart communication with the current values.
	2 Restart with default values	Restart communication with the standard values of the communication parameters.
	5 Stop network communication	Stop communication.
	10 In progress	Only status feedback
	11 Action cancelled	
	12 Error	



8.7.15 PROFIBUS - short setup

In the following, the steps required for controlling the inverter via PROFIBUS are described.

Parameterisation required

1. Activate network control: [0x2631:037 \(P400.37\)](#) = "TRUE [1]"
2. Set network as standard setpoint source: [0x2860:001 \(P201.01\)](#) = "Network [5]"
3. Set PROFIBUS station address.
 - Each network node must be provided with a unique station address.
 - Details: [PROFIBUS station address](#) [□ 268](#)
4. Optional: Change the response of the inverter if the communication to the PROFIBUS master is interrupted.
 - Default setting: If communication is interrupted, an error is triggered.
 - Details: [PROFIBUS monitoring](#) [□ 269](#)
5. Save parameter settings: [0x2022:003 \(P700.03\)](#) = "On / start [1]".
6. Switch the inverter off and then on again in order that the changed communication settings can get effective.
7. Configure the host system (master) in order to enable communication with the inverter. See section "[Configuring the host system \(master\)](#)".
8. Control inverter via RPDO (and evaluate in the current status via TPDO).
 - For assignment of the control word and setpoint selection, see section "[RPDO mapping](#)".
 - For assignment of the status word and actual value output, see section "[TPDO mapping](#)".
 - Acceleration [0x2917 \(P220.00\)](#) and deceleration [0x2918 \(P221.00\)](#) can be set/changed via the acyclic parameter data transfer.



In the default setting, the digital input DI1 is assigned with the "Run" function. If the network control is activated, this function serves as "start enable" for start commands via network. Hence, the digital input DI1 must be set to HIGH level in order that the motor can be started via network. [Start / stop motor](#) [□ 499](#)

Configuring the host system (master)

Configure the host system (master) as follows in order to enable communication with the inverter.

1. Import the device description file of the inverter into the master.

The device description file for the inverter can be found in the Internet:
<http://www.lenze.com> → Download

The following language versions of the device description file can be used:

 - LENZE[product type].GSE (source file, English), e.g. LENZE550.GSE for i550
 - LENZE[product type].GSG (German), e.g. LENZE550.GSG for i550
 - LENZE[product type].GSE (English), e.g. LENZE550.GSE for i550
2. Define the user data length.
 - The user data length is defined during the initialisation phase of the master.
 - The inverter supports the configuration of maximally 16 process data words (maximally 32 bytes).
 - The user data length for process input data and process output data is the same.
3. Execute data mapping in the hardware configurator.
 - For preconfigured PDO mapping, see the sections "[RPDO mapping](#)" and "[TPDO mapping](#)".
 - Details: [PROFIBUS data mapping](#) [□ 273](#)

Configuring the network

PROFIBUS

PROFIBUS - short setup



RPDO mapping

For the process data from the master to the inverter, the following data mapping is preset in the device description file:

1. NetWordIN1 data word [0x4008:001 \(P590.01\)](#)
2. Network setpoint frequency (0.01) [0x400B:005 \(P592.05\)](#)
3. 16 bit selectable output data, mapped to Keypad setpoints: Process controller setpoint [0x2601:002 \(P202.02\)](#)

Function assignment of the NetWordIN1 data word

Bit	Default setting	For details and configuration, see
0	Not active (reserve)	0x400E:001 (P505.01)
1	Not active (reserve)	0x400E:002 (P505.02)
2	Activate quick stop	0x400E:003 (P505.03)
3	Not active (reserve)	0x400E:004 (P505.04)
4	Run forward (CW)	0x400E:005 (P505.05)
5	Activate preset (bit 0)	0x400E:006 (P505.06)
6	Activate preset (bit 1)	0x400E:007 (P505.07)
7	Reset error	0x400E:008 (P505.08)
8	Not active (reserve)	0x400E:009 (P505.09)
9	Activate DC braking	0x400E:010 (P505.10)
10	Not active (reserve)	0x400E:011 (P505.11)
11	Not active (reserve)	0x400E:012 (P505.12)
12	Invert rotation	0x400E:013 (P505.13)
13	Not active (reserve)	0x400E:014 (P505.14)
14	Not active (reserve)	0x400E:015 (P505.15)
15	Not active (reserve)	0x400E:016 (P505.16)

Specifying the frequency setpoint

- The specification is made unsigned (independent of the direction of rotation) as integer in the resolution [0.01 Hz].
- The direction of rotation is defined in the default setting via bit 12 of the NetWordIN1 data word.
- Example: $4560 \equiv 45.60 \text{ Hz}$



TPDO mapping

For the process data from the inverter to the master, the following data mapping is preset in the device description file:

1. NetWordOUT1 data word [0x400A:001 \(P591.01\)](#)
2. Network setpoint frequency (0.01) [0x400B:005 \(P592.05\)](#)
3. Motor current [0x2D88 \(P104.00\)](#)

Status assignment of the NetWordOUT1 data word

Bit	Default setting	For details and configuration, see
0	Ready for operation	0x2634:010 (P420.10)
1	Not connected	0x2634:011 (P420.11)
2	Operation enabled	0x2634:012 (P420.12)
3	Error active	0x2634:013 (P420.13)
4	Not connected	0x2634:014 (P420.14)
5	Quick stop active	0x2634:015 (P420.15)
6	Running	0x2634:016 (P420.16)
7	Device warning active	0x2634:017 (P420.17)
8	Not connected	0x2634:018 (P420.18)
9	Not connected	0x2634:019 (P420.19)
10	Setpoint speed reached	0x2634:020 (P420.20)
11	Current limit reached	0x2634:021 (P420.21)
12	Actual speed = 0	0x2634:022 (P420.22)
13	Rotational direction reversed	0x2634:023 (P420.23)
14	Release holding brake	0x2634:024 (P420.24)
15	Safe torque off (STO) active	0x2634:025 (P420.25)

Output of the actual frequency value

- The output is made unsigned (independent of the direction of rotation) as integer in the resolution [0.01 Hz].
- An active reversal is displayed via bit 13 of the NetWordOUT1 data word.
- Example: 4560 \equiv 45.60 Hz

Configuring the network

EtherNet/IP
PROFIBUS - short setup



8.8 EtherNet/IP



EtherNet/IP™ (EtherNet Industrial Protocol) is a fieldbus system based on Ethernet which uses the Common Industrial Protocol™ (CIP™) for data exchange.

- EtherNet/IP™ and Common Industrial Protocol™ (CIP™) are trademarks and patented technologies, licensed by the user organisation ODVA (Open DeviceNet Vendor Association), USA.
- Detailed information on EtherNet/IP can be found on the web page of the user organisation: <http://www.odva.org>
- Information on the dimensioning of a EtherNet/IP network can be found in the configuration document for the product.

Preconditions

- The control unit (CU) of the inverter is provided with EtherNet/IP (from firmware 02.01).
- For commissioning, a programming tool (e. g. »RSLogix™ 5000« for »Allen-Bradley®« control) and current device description files for EtherNet/IP are available:
 - Download »RSLogix™ 5000«
 - Download of EDS files for Lenze devices
- Registered trademarks used or trademarks of the Rockwell Automation® Corporation, USA.
 - »RSLogix™«, »RSLogix™ 5000«
 - »Allen-Bradley®«
 - »CompactLogix™«, »ControlLogix®«, »SoftLogix™«



8.8.1 EtherNet/IP characteristics

Properties and supported services	
CIP connections	max. 8
Additional TCP/IP socket connections	✓
Automatic detection of data rates (Auto-Negotiation)	✓
Data transfer	Explicit Messaging: ▶ EtherNet/IP - acyclic data transfer □ 301 Implicit Messaging: ▶ EtherNet/IP - cyclic data transfer □ 298
Scalable quantity of I/O process data words	✓
Maximum process data length per direction (Rx/Tx)	16 bytes
Parameter access data channel	✓
AC Drive Profile □ 221	✓
Customer specific configurations □ 223	✓
Multicast messages	✓
Minimum cycle time, RPI (Requested Packet Interval)	4 ms
Cycle time steps	4 ... 128 ms
Cycle time towards the axis	≤ 6 ms
Port-to-port latency	≤ 125 μs
ACD (Address Conflict Detection)	✓
ARP (Address Resolution Protocol, RFC 826)	✓
BOOTP (Bootstrap Protocol)	✓
DHCP (Dynamic Host Configuration Protocol)	✓
DLR (Device Level Ring Protocol)	✓
DLR supervisor mode	-
DSCP (Differentiated Services Codepoints)	✓
ICMP (Internet Control Messaging Protocol, RFC 792)	✓
IEEE 802.3 (Ethernet, RFC 894)	✓
IGMP (Internet Group Management Protocol)	V2
IP (Internet Protocol, RFC 791)	V4
QoS (Quality of Service)	✓
TCP (Transmission Control Protocol, RFC 793)	✓
UCMM (Unconnected Message Manager)	✓
UDP (User Datagram Protocol, RFC 768)	✓
VLAN-Tagging	✓
✓ Is supported. - Is not supported.	

Configuring the network

EtherNet/IP
EtherNet/IP configuration



8.8.2 EtherNet/IP configuration

IP basic settings

The PC with the engineering software must be in the same network as the devices to be configured.

First, configure the PC so that this condition is fulfilled.

The required steps are described by the example of the operating system Microsoft® Windows® 7.

How to define the IP basic settings:

1. Call the "Mains and release center" under "System control".
2. Select "Change adapter settings" (observe administrator rights!).
3. Select the network to be configured (double-click), e. g.:

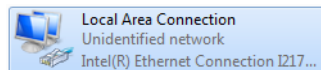

The network nodes (PLC, inverter) must be connected to the network.

The status dialog box of the network is opened.

4. Click "Properties".

The properties dialog box of the network is opened.

5. Select "Internet protocol version 4 (TCP/IPv4)" and click "Properties".

The properties dialog box of the "Internet protocol version 4 (TCP/IPv4)" is opened.

6. Enter the IP address, the subnet mask and, if required, the gateway address under "Use the following addresses".

7. Click "OK".

The IP basic settings are now completed.

Set IP address

The rotary encoder switches at the front of the device serve to set the IP address in terms of hardware.

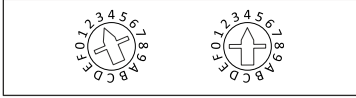
Setting	Addressing
0x00	IP address via parameter 0x23A1:001 (P510.01) .
0x01 ... 0xFF	Setting of the 4th byte of the IP address via the rotary encoder switch. XXX.XXX.XXX.[setting] Example: Setting for the value 52 $(3 \times 16) + (4 \times 1) = 52$ 

The value set via the rotary encoder switches is used when the mains is switched on or after a network restart with [0x23A0 \(P508.00\)](#) = 1 or 2. A changed value during operation will only become valid after the network has been restarted.

- [0x23A3 \(P509.00\)](#) shows the switch setting at the last mains connection.
- [0x23A2:001 \(P511.01\)](#) shows the active IP address.

Set subnet mask

The desired subnet mask is set via [0x23A1:002 \(P510.02\)](#).

[0x23A2:002 \(P511.02\)](#) shows the active subnet mask.

Set gateway address

If a gateway is used, set the gateway address via [0x23A1:003 \(P510.03\)](#).

[0x23A2:003 \(P511.03\)](#) shows the active gateway address.



Set host name

Set the desired host name (max. 64 characters) via [0x23A1:004 \(P510.04\)](#).

Since DNS is not supported, the host name only serves to identify the device.

IP configuration

As an alternative to the manual setting of the IP addresses, a DHCP or BOOTP server can also be used to assign the IP addresses to each single network node.

[0x23A1:005 \(P510.05\)](#) serves to define whether the currently saved IP addresses are used or the IP addresses are assigned by means of DHCP or BOOTP.

Multicast settings



We recommend you to keep the default settings in order to ensure a safe multicast transmission.

Multicast enables the transfer of data packages to several nodes or to a closed node group at the same time. For this purpose, the scanner automatically generates a multicast IP address for the device.

The preset **multicast TTL value** is 1, which means that the multicast data packages are only transferred via the local subnetwork. Contact your IT department for the correct setting of the respective network installation.

The multicast settings can also be made manually via the following parameters:

- [0x23A1:008 \(P510.08\)](#): Multicast IP address
- [0x23A1:007 \(P510.07\)](#): Multicast allocation
- [0x23A1:006 \(P510.06\)](#): Multicast TTL
- [0x23A1:009 \(P510.09\)](#): Multicast number

Set the baud rate for the Ethernet ports manually

By default, the device automatically recognises the baud rate of the connected Ethernet network.

For the Ethernet ports of the device, you can also set the baud rate explicitly and define whether the communication is to be half duplex or full duplex:

- [0x23A4:001 \(P512.01\)](#): Setting of the baud rate for Ethernet port 1
- [0x23A4:002 \(P512.02\)](#): Setting of the baud rate for Ethernet port 2
- [0x23A5:001 \(P519.01\)](#): Display of the active baud rate for Ethernet port 1
- [0x23A5:002 \(P519.02\)](#): Display of the active baud rate for Ethernet port 2

Address conflict detection (ACD)

[0x23A7 \(P514.00\)](#) can be used to activate and deactivate the Address conflict detection.

In the default setting, the Address conflict detection is activated.

Quality of service (QoS)

[0x23A6 \(P513.00\)](#) displays if the QoS tag (802.1Q) for prioritising the data packages to be transmitted is used.

The parameters for configuring the network of the device are described below.

Parameter	Name / value range / [default setting]	Info
0x23A1:001 (P510.01)	EtherNet/IP settings: IP address (EtherN/IP sett.: IP address) 0 ... [276605120] ... 4294967295 • From version 02.00	Set IP address. The default setting 276605120 corresponds to the IP address 192.168.124.16. • 276605120 = 0x107CA8C0 → 0xC0.0xA8.0x7C.0x10 = 192.168.124.16
0x23A1:002 (P510.02)	EtherNet/IP settings: Subnet (EtherN/IP sett.: Subnet) 0 ... [16777215] ... 4294967295 • From version 02.00	Set subnet mask. The default setting 16777215 corresponds to the subnet mask 255.255.255.0. • 16777215 = 0xFFFFF → 0xFF.0xFF.0xFF.0x00 = 255.255.255.0

Configuring the network

EtherNet/IP

EtherNet/IP configuration

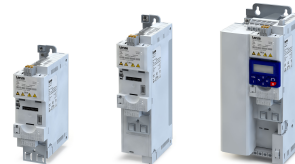

Parameter	Name / value range / [default setting]	Info
0x23A1:003 (P510.03)	EtherNet/IP settings: Gateway (EtherN/IP sett.: Gateway) 0 ... [0] ... 4294967295 • From version 02.00	Set gateway address. Example: The setting 276344004 corresponds to the gateway address 196.172.120.16. • 276344004 = 0x1078ACC4 → 0xC4.0xAC.0x78.0x10 = 196.172.120.16
0x23A1:004 (P510.04)	EtherNet/IP settings: Host name (EtherN/IP sett.: Host name) • From version 02.00	Set host name. • String with up to 64 characters.
0x23A1:005 (P510.05)	EtherNet/IP settings: IP configuration (EtherN/IP sett.: IP configuration) • From version 02.00	Set IP configuration.
	0 Stored IP	The currently saved IP configuration is used.
	1 BOOTP	The IP configuration is assigned by the Scanner via BOOTP.
	2 DHCP	The IP configuration is assigned by the Scanner via DHCP. The assignment of a gateway address that is not in the same subnetwork as the IP address, is denied.
0x23A1:006 (P510.06)	EtherNet/IP settings: Multicast TTL (EtherN/IP sett.: Multicast TTL) 0 ... [1] ... 255 • From version 02.00	Setting of the multicast TTL value for the validity of data packages in the network.
0x23A1:007 (P510.07)	EtherNet/IP settings: Multicast allocation (EtherN/IP sett.: Mcast allocation) • From version 02.00	Selection for multicast-IP addressing.
	0 Default allocation	
	1 Multicast number/start address	
0x23A1:008 (P510.08)	EtherNet/IP settings: Multicast IP address (EtherN/IP sett.: Mcast IP addr.) 0 ... [3221373167] ... 4294967295 • From version 02.00	Set multicast IP address. The default setting 3221373167 corresponds to the Multicast IP address 239.64.2.192. • 3221373167 = 0xC00240EF → 0xEF.0x40.0x02.0xC0 = 239.64.2.192
0x23A1:009 (P510.09)	EtherNet/IP settings: Multicast number (EtherN/IP sett.: Multicast number) 1 ... [1] ... 8 • From version 02.00	Set multicast number.
0x23A4:001 (P512.01)	Port settings: Port 1 (Port settings: Port 1) • From version 02.00	Set baud rate for Ethernet port 1.
	0 Auto-Negotiation	
	1 10 Mbps	
	2 100 Mbps	
	3 Reserved	
	4 Reserved	
	5 10 Mbps/Half Duplex	
	6 10 Mbps/Full Duplex	
	7 100 Mbps/Half Duplex	
	8 100 Mbps/Full Duplex	
	9 Reserved	
	10 Reserved	
	11 Reserved	
12 Reserved		



Parameter	Name / value range / [default setting]	Info
0x23A4:002 (P512.02)	Port settings: Port 2 (Port settings: Port 2) • From version 02.00	Set baud rate for Ethernet port 2.
	0 Auto-Negotiation	
	1 10 Mbps	
	2 100 Mbps	
	3 Reserved	
	4 Reserved	
	5 10 Mbps/Half Duplex	
	6 10 Mbps/Full Duplex	
	7 100 Mbps/Half Duplex	
	8 100 Mbps/Full Duplex	
	9 Reserved	
	10 Reserved	
	11 Reserved	
12 Reserved		
0x23A7 (P514.00)	Address conflict detection (AddrConflictDetec) • From version 02.00	Activate address conflict detection (ACD) (enable). • If this value is changed, the device must be reset ("Power off/on" or "Type 0 Reset").
	0 Disabled	
	1 Enabled	
0x23A3 (P509.00)	EtherNet/IP switch position (EtherN. switch) • Read only • From version 02.00	Display of the rotary encoder switch settings at the last mains power-on.
0x23A6 (P513.00)	Quality of service (QualityOfService) • Read only • From version 02.00	Display if the QoS tag for prioritising the data packages to be transmitted is used.
	0 802.1Q Tag disable	
	1 802.1Q Tag enable	

8.8.3 EtherNet/IP monitoring

The parameters for setting network monitoring functions are described below.

Parameter	Name / value range / [default setting]	Info
0x23A1:010 (P510.10)	EtherNet/IP settings: Timeout (EtherN/IP sett.: Timeout) 500 ... 10000 ... 65535 ms • From version 02.00	Setting of the maximum permissible time-out for the CIP communication. When the specified monitoring time has elapsed, the response set in 0x2859:007 (P515.07) is triggered in the inverter.
0x2859:001 (P515.01)	EtherNet/IP monitoring: Watchdog elapsed (EtherN/IP monit.: WD elapsed) • From version 02.00 • For further possible settings, see parameter 0x2D45:001 (P310.01) . 196	Selection of the response to a permanent interruption of the communication to the Scanner, e. g. by cable break or failure of the Scanner. Associated error code: • 33168 0x8190 - Network: watchdog timeout
	2 Trouble	▶ Error types 113
0x2859:003 (P515.03)	EtherNet/IP monitoring: Invalid configuration (EtherN/IP monit.: Invalid config) • From version 02.00 • For further possible settings, see parameter 0x2D45:001 (P310.01) . 196	Selection of the response triggered by the reception of invalid configuration data. Associated error code: • 33414 0x8286 - Network: PDO mapping error
	2 Trouble	▶ Error types 113
0x2859:004 (P515.04)	EtherNet/IP monitoring: Initialisation error (EtherN/IP monit.: Init. error) • From version 02.00 • For further possible settings, see parameter 0x2D45:001 (P310.01) . 196	Selection of the response triggered by the occurrence of an error during the initialisation of the network component. Associated error code: • 33170 0x8192 - Network: initialisation error
	2 Trouble	▶ Error types 113

Configuring the network

EtherNet/IP

EtherNet/IP monitoring







Parameter	Name / value range / [default setting]	Info
0x2859:005 (P515.05)	EtherNet/IP monitoring: Invalid process data (EtherN/IP monit.: Inval. proc.data) <ul style="list-style-type: none"> From version 02.00 For further possible settings, see parameter 0x2D45:001 (P310.01). 196 	Selection of the response triggered by the reception of invalid process data. Associated error code: <ul style="list-style-type: none"> 33171 0x8193 - Network: invalid cyclic process data
	2 Trouble	Error types 113
0x2859:006 (P515.06)	EtherNet/IP monitoring: Timeout explicit message (EtherN/IP monit.: Timeout ExplMsg) <ul style="list-style-type: none"> From version 02.00 For further possible settings, see parameter 0x2D45:001 (P310.01). 196 	Selection of the response to time-outs during the transfer of Explicit Messages. Associated error code: <ul style="list-style-type: none"> 33042 0x8112 - Network: timeout explicit message
	1 Warning	Error types 113
0x2859:007 (P515.07)	EtherNet/IP monitoring: Timeout communication (EtherN/IP monit.: Timeout Comm.) <ul style="list-style-type: none"> From version 02.00 For further possible settings, see parameter 0x2D45:001 (P310.01). 196 	Selection of the response to the time-out during the CIP communication. Selection of the response to the time-out during the CIP communication. The monitoring time for the CIP communication is defined in 0x23A1:010 (P510.10) . Associated error code: <ul style="list-style-type: none"> 33044 0x8114 - Network: overall communication timeout
	1 Warning	Error types 113







8.8.4 EtherNet/IP LED status displays

Information on the CIP status can be obtained quickly via the "MS" and "NS" LED displays on the front of the inverter. In addition, the LEDs at the RJ45 sockets indicate the Ethernet connection status.

The meaning of the "MS" and "NS" LEDs can be obtained from the following two tables.

LED "MS" (green/red)	CIP module status	Status/meaning
off	Nonexistent	The network option is not supplied with voltage.
 On (green)	Operational	The network option works correctly.
 Blinking green	Standby	The network option is not configured completely or the configuration is incorrect.
 Blinking red	Major recoverable fault	The network option contains a correctable error.
 On (red)	Major unrecoverable fault	The network option contains a non-correctable error.
 Blinking green/red	Device self testing	The network option executes a self-test.

LED "NS" (green/red)	CIP network status	Status/meaning
off	No IP address	The network option is not supplied with voltage or has not received an IP address yet.
 On (green)	Connected	The network option works correctly and has established a connection to the scanner.
 Blinking green	No connections	The network option <ul style="list-style-type: none"> works correctly, has been assigned to an IP address, has not been implemented into the network yet by the scanner.
 Blinking red	Connection timeout	A time-out has occurred.
 On (red)	Duplicate IP	The network option cannot access the network (IP address conflict).
 Blinking green/red	Device self testing	The network option executes a self-test.

Status displays at the RJ45 sockets

The LEDs at the RJ45 sockets indicate the Ethernet connection status:

LED "Link" (green)	Status/meaning
off	No Ethernet connection.
 on	A physical Ethernet connection is available.

LED "Activity" (yellow)	Status/meaning
off	No Ethernet data transfer.
 on or flickers	Data is exchanged via Ethernet.

8.8.5 EtherNet/IP diagnostics

The parameters for diagnosing the network are described below.

Parameter	Name / value range / [default setting]	Info
0x23A2:001 (P511.01)	Active EtherNet/IP settings: IP address (EtherN/IP diag.: IP address) <ul style="list-style-type: none"> Read only From version 02.00 	Display of the active IP address. The default setting 276605120 corresponds to the IP address 192.168.124.16. <ul style="list-style-type: none"> 276605120 = 0x107CA8C0 → 0xC0.0xA8.0x7C.0x10 = 192.168.124.16
0x23A2:002 (P511.02)	Active EtherNet/IP settings: Subnet (EtherN/IP diag.: Subnet) <ul style="list-style-type: none"> Read only From version 02.00 	Display of the active subnet mask. The default setting 16777215 corresponds to the subnet mask 255.255.255.0. <ul style="list-style-type: none"> 16777215 = 0xFFFFF → 0xFF.0xFF.0xFF.0x00 = 255.255.255.0

Configuring the network

EtherNet/IP
EtherNet/IP objects

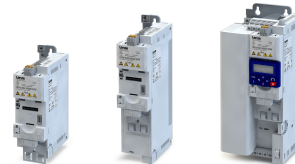

Parameter	Name / value range / [default setting]	Info
0x23A2:003 (P511.03)	Active EtherNet/IP settings: Gateway (EtherN/IP diag.: Gateway) • Read only • From version 02.00	Display of the active gateway address. Example: The setting 276344004 corresponds to the gateway address 196.172.120.16. • 276344004 = 0x1078ACC4 → 0xC4.0xAC.0x78.0x10 = 196.172.120.16
0x23A2:005 (P511.05)	Active EtherNet/IP settings: MAC address (EtherN/IP diag.: MAC address) • Read only • From version 02.00	Display of the active MAC address.
0x23A2:006 (P511.06)	Active EtherNet/IP settings: Multicast address (EtherN/IP diag.: Mcast address) • Read only • From version 02.00	Display of the active Multicast IP address. The default setting 3221373167 corresponds to the Multicast IP address 239.64.2.192. • 3221373167 = 0xC00240EF → 0xEF.0x40.0x02.0xC0 = 239.64.2.192
0x23A5:001 (P519.01)	Active port settings: Port 1 (Port diagnostics: Port 1) • Read only • From version 02.00	Display of the active baud rate for Ethernet port 1.
	0 Not connected	
	1 10 Mbps/Half Duplex	
	2 10 Mbps/Full Duplex	
	3 100 Mbps/Half Duplex	
4 100 Mbps/Full Duplex		
0x23A5:002 (P519.02)	Active port settings: Port 2 (Port diagnostics: Port 2) • Read only • From version 02.00	Display of the active baud rate for Ethernet port 2.
	0 Not connected	
	1 10 Mbps/Half Duplex	
	2 10 Mbps/Full Duplex	
	3 100 Mbps/Half Duplex	
	4 100 Mbps/Full Duplex	
	5 Reserved	
6 Reserved		
0x23A8 (P516.00)	CIP module status (CIP module stat.) • Read only • From version 02.00	Display of the active CIP module status.
0x23A9 (P517.00)	EtherNet/IP status (EtherN/IP status) • Read only • From version 02.00	Display of the active network status.

8.8.6 EtherNet/IP objects

The parameters for the implemented EtherNet/IP objects are described below.

Parameter	Name / value range / [default setting]	Info
0x400B:010	AC Drive mode	Selection of the AC drive mode.
	0 Vendor specific	
	1 Speed control (open loop)	
	2 Speed control (closed loop)	
3 Torque control (from version 03.00)		



Configuring the network

EtherNet/IP
EtherNet/IP commissioning

Parameter	Name / value range / [default setting]	Info
0x2631:017 (P400.17)	Function list: Activate network setpoint (Function list: Setp: Network) <ul style="list-style-type: none"> From version 02.01 For further possible settings, see parameter 0x2631:001 (P400.01). □ 500 	Assignment of a trigger for the "Activate network setpoint" function. Trigger = TRUE: the network is used as setpoint source (if the trigger assigned has the highest setpoint priority). Trigger = FALSE: no action / deactivate function again.
	0 Not connected	No trigger assigned (trigger is constantly FALSE).
	116 Network setpoint active (from version 02.00)	TRUE if a change-over to network setpoint is requested via bit 6 of the AC drive control word 0x400B:001 (P592.01) . Otherwise FALSE. Notes: <ul style="list-style-type: none"> Set this selection if the network setpoint is to be activated via bit 6 of the AC drive control word. The AC drive control word can be used with any communication protocol. ▶ AC Drive Profile □ 221
0x6402	Motor type <ul style="list-style-type: none"> From version 02.00 	AC motor type <ul style="list-style-type: none"> Motor Data Object (0x28) - instance attribute 3
	3 PM synchronous	
	6 Wound rotor induction	
	7 Squirrel cage induction	

8.8.7 EtherNet/IP commissioning

Restart of the network communication

The network communication is restarted with [0x23A0 \(P508.00\)](#) = 1 or 2.

Parameter	Name / value range / [default setting]	Info
0x23A0 (P508.00)	EtherNet/IP communication (EtherN/IP comm.) <ul style="list-style-type: none"> From version 02.00 	Restart / stop communication. <ul style="list-style-type: none"> When the device command has been executed successfully, the value 0 is shown.
	0 No action/no error	Only status feedback
	1 Restart with current values	Restart communication with the current values.
	2 Restart with default values	Restart communication with the standard values.
	5 Stop network communication	Stop communication.
	10 In process	Only status feedback
	11 Action cancelled	
	12 Fault	

Configuring the network

EtherNet/IP

EtherNet/IP - cyclic data transfer



8.8.8 EtherNet/IP - cyclic data transfer

Implicit Messaging

How to configure the cyclic data transfer (Implicit Messaging) in »RSLogix™ 5000« (version 20):

1. Network configuration of the inverter.

1. In the navigation tree ("Controller Organizer") go to "I/O Configuration → Ethernet" and execute the context menu command "New Module" with a right-click.
2. In the appearing dialog box, select the "ETHERNET MODULE Generic Ethernet Module" module type.
3. Click "Create".

The "New Module" dialog box is opened.

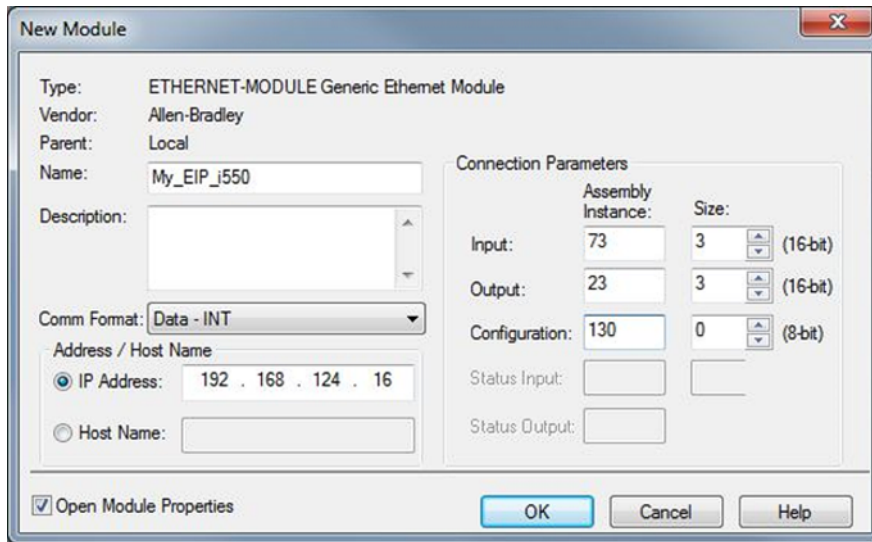

4. Fill in input fields.



The inverter (adapter) must be in the same subnetwork as the PLC (scanner). The subnetwork corresponds to the first three bytes of the IP address.

The size of the assemblies must correspond to the number of words that are actually used.

Bits 5 and 6 of byte 0 in the assembly "23" must be transmitted for the inverter in order that the control and speed reference commands are accepted by the network.

If the network control is active ([0x400B:001 \(P592.01\)](#)/bit 5 = 1 and [0x2631:037 \(P400.37\)](#) = 114), all bits of the AC drive control word ([0x400B:001 \(P592.01\)](#)) are processed.

If the network control is not active ([0x400B:001 \(P592.01\)](#)/bit 5 = 0 or [0x2631:037 \(P400.37\)](#) = 0), the control bits 0, 1, 12, 13, 14, 15 are *not* processed. Their states are ignored and the drive is in local control.

See also: [▶ AC Drive Profile](#) [□ 221](#)

In the example ...

- a) the name "My_EIP_i550" is entered.
 - b) "Data-INT" is selected for the "Comm Format" since the data in the assemblies of this examples are given in 16-bit-integer words.
 - c) the IP address "192.168.124.16" is entered for the inverter (adapter).
 - d) the instance "73" and the size "3" are entered for the output assembly.
 - e) the instance "23" and the size "3" are entered for the output assembly.
 - f) the instance "130" and the size "0" are entered for the configuration assembly.
5. Click "OK".

The "Module Properties Report: ..." dialog box is opened.

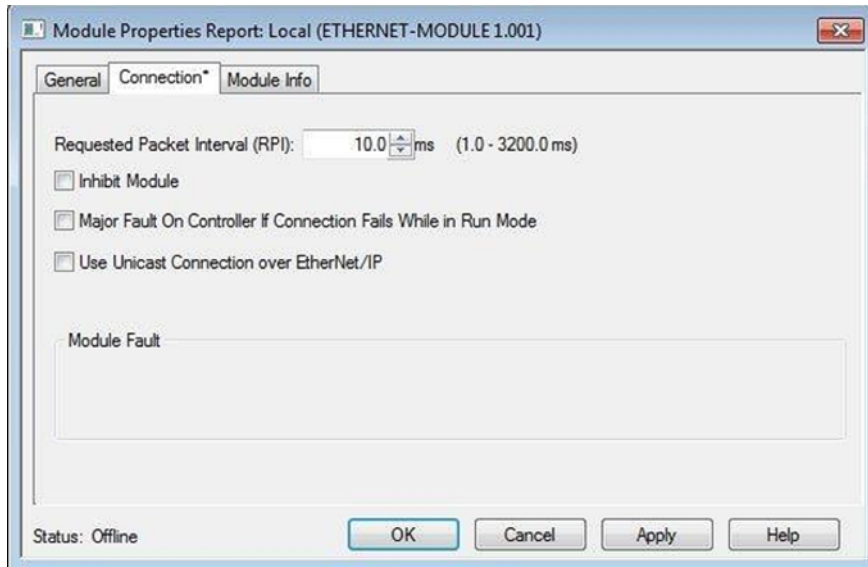

6. Set the RPI rate.

The example shows the default setting of the RPI rate with "10.0" ms. This means that the inverter is queried every 10 milliseconds by the scanner. For the most inverter applications, it is not required to query the inverter more frequently.

The minimum value for inverters of the i series is 4.0 ms.

7. Activate/deactivate "Use Unicast Connection over EtherNet/IP".

The inverter supports "Unicast Connection over EtherNet/IP". The activation of this function causes a faster overall network power. The use of this function may, however, make the error correction for managed switches more complicated.

8. Make optional settings.

- a) Activating "Inhibit Module" disables the inverter.
- b) Activating "Major Fault On Controller If Connection Fails While in Run Mode" switches the inverter to "Fault" if the EtherNet/IP connection to the inverter gets lost during operation.

9. Click "OK".

The network configuration of the inverter is now completed.

In the navigation tree ("Controller Organizer") under "Controller → Controller Tags", assembly tags are generated.

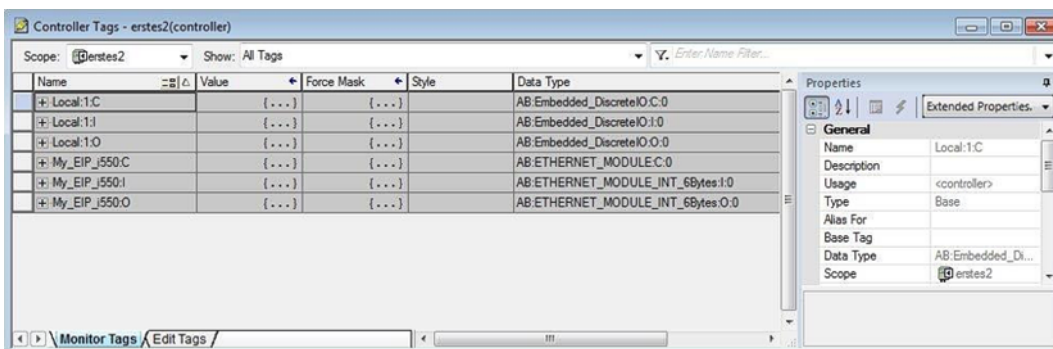

In the sample configuration with the inverter "My_EIP_i550", these three assembly tags are generated:

"My_EIP_i550:C" for the configuration assembly

"My_EIP_i550:I" for the input assembly

"My_EIP_i550:O" for the output assembly

By clicking [+] in front of the assembly names, the display of the assemblies is extended.

Configuring the network

EtherNet/IP

EtherNet/IP - cyclic data transfer



Here, the four words are displayed the output assembly "My_EIP_i550:O" consists of:

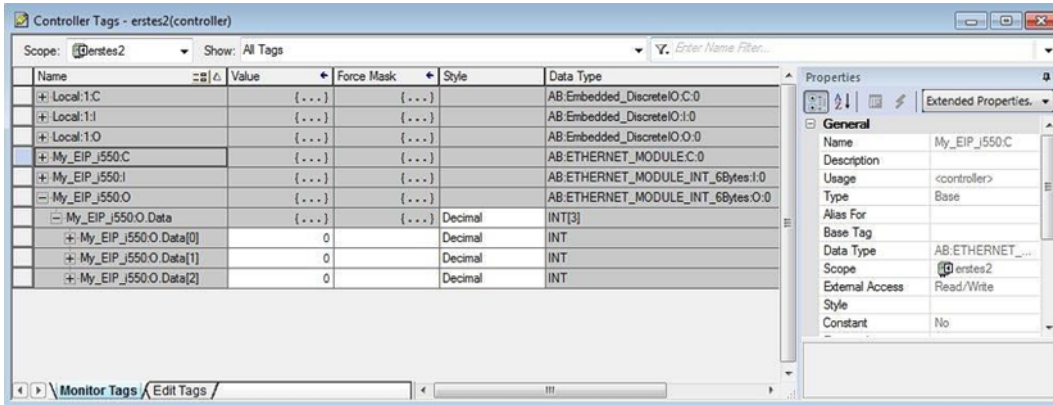

2. Creating alias tags for individual bits of the assemblies.

1. Go to the navigation tree (Controller Organizer) under "Controller" and open "Controller Tags".
2. Execute the context menu command "New Tag" with a right-click.
The "New Tag" dialog box is opened.

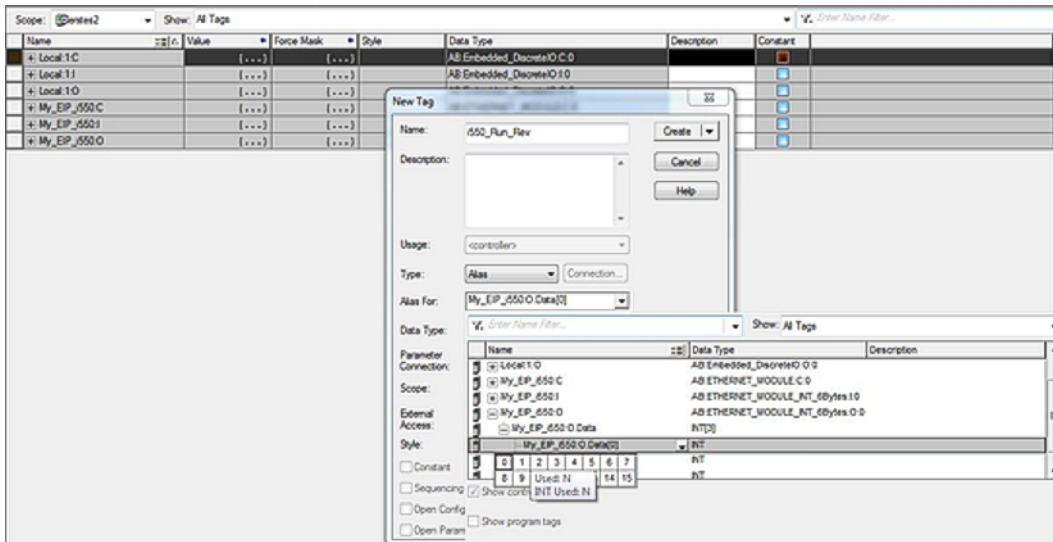

3. Fill in input fields.

In the example ...

- a) the name "i550_Run_Rev" is entered.
 - b) the type "Alias" is selected.
 - c) in the output assembly word "My_EIP_i550:O.Data[0]", "Run_Rev" is assigned to bit 1.
4. Click "Create".

The new alias tag is added to the database.

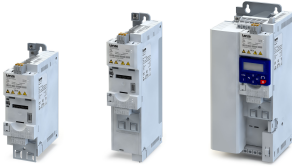

8.8.9 EtherNet/IP - acyclic data transfer

- The acyclic/non-cyclic data access (service access) provides a procedure for the PLC (scanner) to access any drive or device parameter.
- This type of parameter access is typically used for ...
 - monitoring or the not time-controlled parameter access with low priority;
 - writing parameter data (assembly data) for controlling the inverter (adapter).
- For this purpose, the device supports several methods.

Explicit Messaging

An explicit message is a logic instruction in the PLC program for the message transfer. It can be used to read or write a parameter setting or the data of an EtherNet/IP node (assembly data).

If the Allen-Bradley control systems »CompactLogix™«, »ControlLogix®« and »SoftLogix™« are used, the "Explicit Message" instruction provides the functionalities described in the following sections. More PLC types can be found in the programming documentation of the PLC.

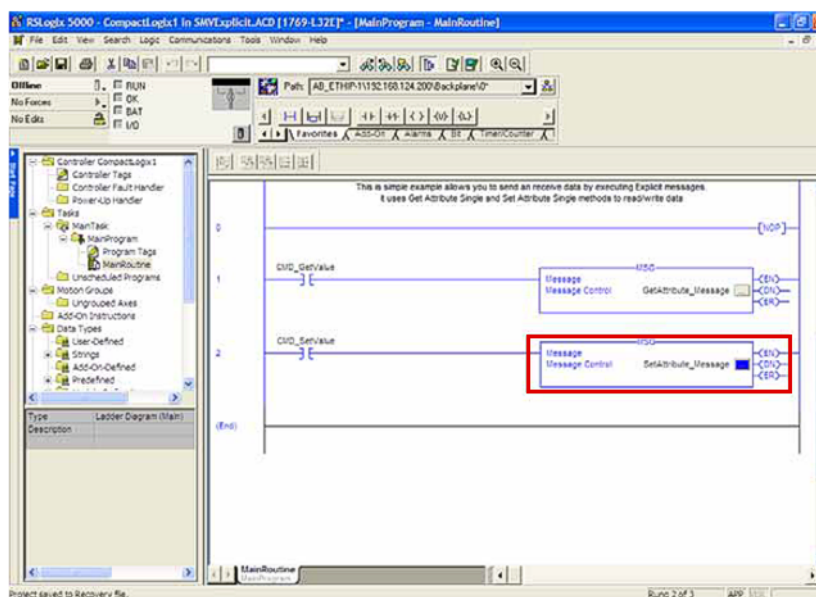

General drive variables (parameters and subindices) are contained in class "0x6E". The instance is the index number of the parameter and the attribute is the subindex number. If no subindex is available, the attribute must be set to "0x00". The attribute value "0x01" is only supported for those clients that do not support the attribute value "0x00".

All these variables have the data type SINT (8 bit, 1-byte objects), INT (16 bit, 2-byte objects) or DINT (32 bit, 4-byte objects).

The device parameters and the PLC program variables must have the same data lengths!

See also: [AC Drive Profile](#) [221](#)

Configuring the network

EtherNet/IP

EtherNet/IP - acyclic data transfer



Read parameter value

Definitions to read a parameter value (Adapter → Scanner):

- Message Type = CIP Generic
- Service Code = 0x0E (read parameter, Get_Attribute_Single)
- Class = 0x6E (hex)
- Instance = index number of the parameter
- Attribute = parameter subindex number (or 0x01 in case of no subindex)
- Destination Element = target variable in the PLC (scanner) for the parameter data to be read.

The variable must have the same format and data length as the parameter!

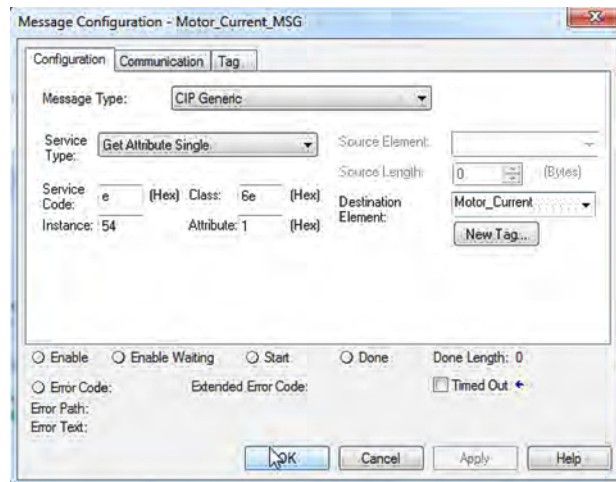

Write parameter value

Definitions to write a parameter value (Scanner → Adapter):

- Message Type = CIP Generic
- Service Code = 0x10 (write parameter, Set_Attribute_Single)
- Class = 0x6E
- Instance = index number of the parameter
- Attribute = parameter subindex number (or 0x01 in case of no subindex)
- Source Element = variable in the PLC (scanner) which is used as source of the parameter data to be written.
- Source Length = data length (bytes) of the data to be written

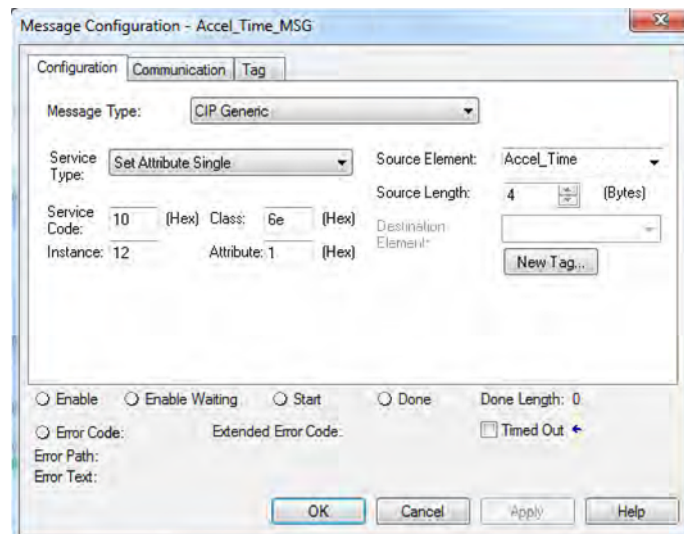



CIP Generic Master(read/write assembly data)

For "CIP Generic Master" that do not support the Implicit Messaging (class 1), the assembly data can be read or written via Explicit Messaging (class 3).

Definitions to read assembly data (Adapter → Scanner):

- Message Type = CIP Generic
- Service Code = 0x0E (read assembly data, Get_Attribute_Single)
- Class = 0x04
- Instance = assembly number in the desired device (e. g. 73 for assembly "73")
- Attribute = 0x03
- Destination Element = target array in the PLC (scanner) for the assembly data to be read.

The array must have the INT format and the same data length as the desired assembly!

Definitions to write assembly data (Scanner → Adapter):

- Message Type = CIP Generic
- Service Code = 0x10 (write assembly data, Set_Attribute_Single)
- Class = 0x04 (hex)
- Instance = assembly number in the desired device (e. g. 23 for assembly "23")
- Attribute = 0x03
- Source Element = INT array in the PLC (scanner) that is used as source of the assembly data to be written.
- Source Length = data length (bytes) of the INT array to be written (the assembly "23" contains e. g. 3 words which corresponds to 6 bytes.)

Explicit Message Path

For each explicit message, the path must be specified in order to forward the message from the Ethernet port of the PLC (scanner) to the IP address of the inverter (adapter). This path depends on the used PLC. If required, contact the PLC manufacturer to find out how the path is specified.



Explicit Messaging Timeout

It is often desirable to set an error time-out state to prevent the inverter from operating continuously.

For this purpose, set these parameters:

- 0x23A1:010 (P510.10): Timeout
- 0x2859:007 (P515.07): Timeout communication

Configuring the network

EtherNet/IP

Basic drive control via EtherNet/IP

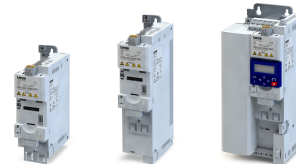

8.8.10 Basic drive control via EtherNet/IP

Typically, an EtherNet/IP network consists of segments that contain point-to-point connections in a star configuration.

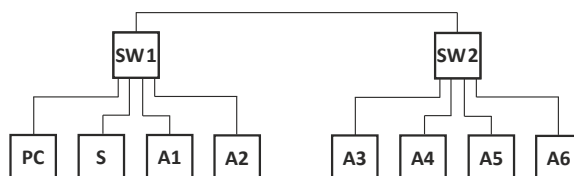

Fig. 6: EtherNet/IP network with two switches in star configuration

PC Engineering PC

A Adapter

S Scanner

SW Switch

In the following, the required steps are described to control the device as EtherNet/IP adapter.

Preconditions

- The device is networked as EtherNet/IP adapter with an EtherNet/IP scanner and, if necessary, further EtherNet/IP nodes.
- An Engineering PC with an installed »RSLogix™ 5000« (version 20) is connected to the scanner.
 - Download »RSLogix™ 5000«
- An »RSLogix™ 5000« project with current device description files for EtherNet/IP is available.
 - Download of EDS files for Lenze devices
 - The files are installed via the "EDS Hardware Installation Tool" of the »RSLogix™ 5000«.
 - Allen-Bradley control systems do not need any EDS files to add devices to their configuration.
- All EtherNet/IP nodes are supplied with voltage and are switched on.



Configuring the network

EtherNet/IP
Basic drive control via EtherNet/IP

How to configure the network:

1. Configure IP communication.

1. Make IP basic settings at the Engineering PC.

The PC with the programming tool »RSLogix™ 5000« must be in the same network as the devices to be configured.

2. Set IP address of the inverter (adapter) via rotary encoder switch and parameter [0x23A1:001 \(P510.01\)](#).
3. Set subnet mask: [0x23A1:002 \(P510.02\)](#)
4. Set gateway address: [0x23A1:003 \(P510.03\)](#)

The configuration of the IP communication is now completed.

Further information on this: [▶ EtherNet/IP configuration](#) 290

2. Activate network control in the inverter.

1. Activate network control: [0x2631:037 \(P400.37\)](#) = "Network control active [114]"
2. Set network as standard setpoint source: [0x2860:001 \(P201.01\)](#) = "Network [5]"

The network control is now activated.

Further information on this: [▶ General network settings](#) 298

3. Save parameter settings: [0x2022:003 \(P700.03\)](#) = "On / start [1]"

3. Execute I/O configuration with »RSLogix™ 5000« (version 20).

1. Start »RSLogix™ 5000«.
2. Open or recreate an »RSLogix™« project.
3. Open the "Select Module Type" dialog box.

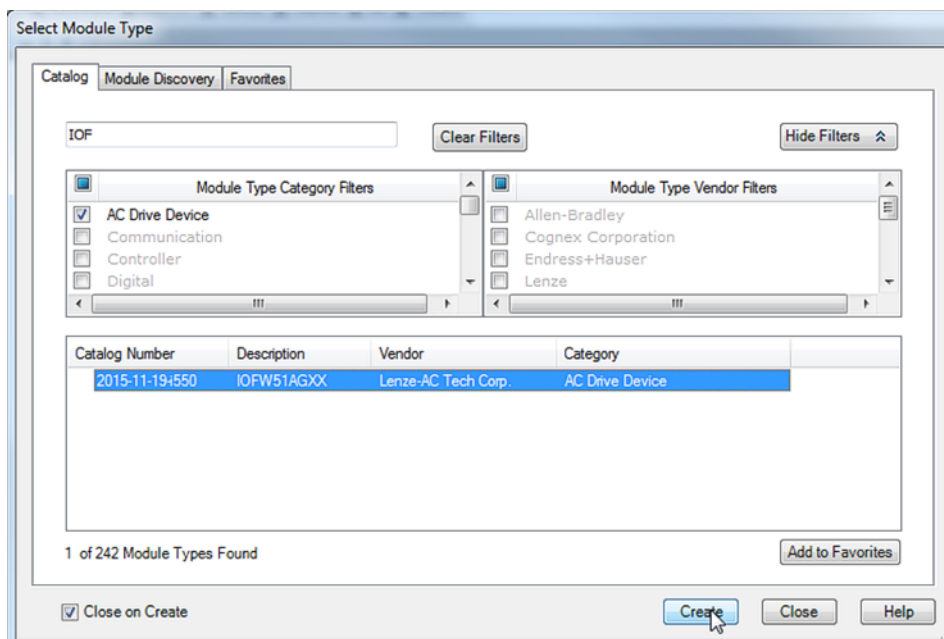

4. Go to the "Catalog" ... tab and
 - a) and select the "AC Drive Device" type category.
 - b) select the "IOFW51AGXX" catalog.
5. Click "Create".

The "New Module" dialog box is opened.

Configuring the network

EtherNet/IP

Basic drive control via EtherNet/IP

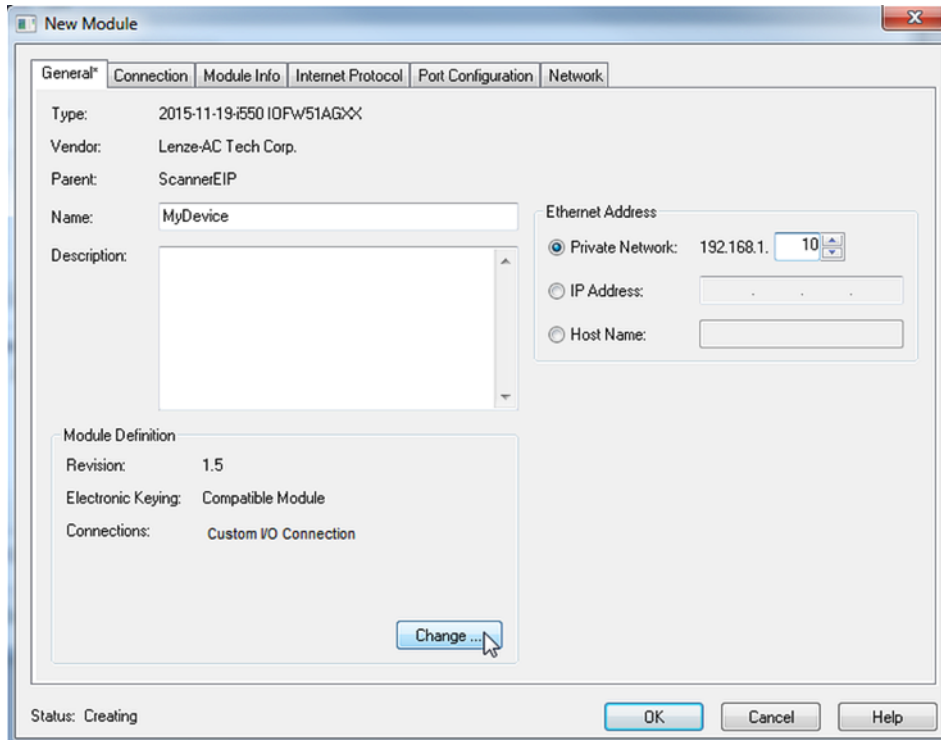

6. Go to the "General" ... tab and
 - a) assign a name for the inverter.
 - b) assign an *unambiguous* IP address.



DNS is not supported.

The host name only describes the device.

7. Click "Change".
8. Open the "Module Definition" dialog box.

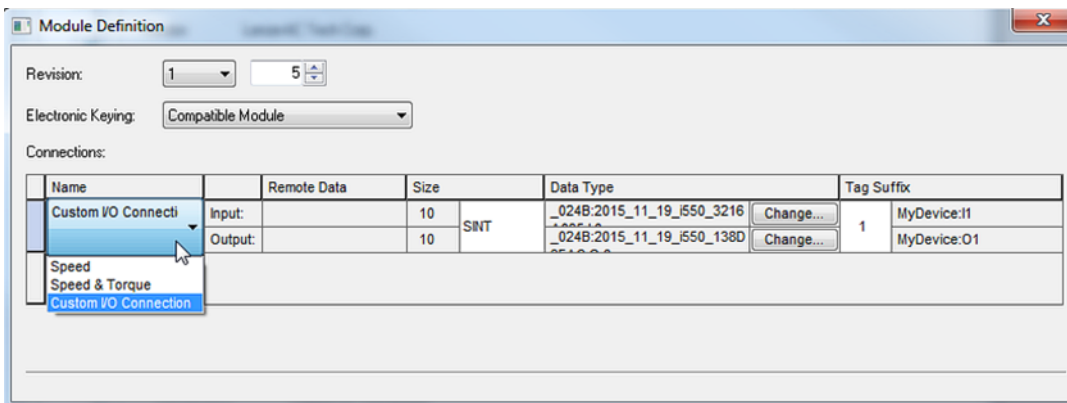

9. Here, the access to the I/O data for the technology applications "Speed" and "Torque" or a user-definable I/O process data set is defined.
 - a) Select the connection "Speed", "Speed & Torque" or "Custom I/O Connection".

"Speed" and "Torque" correspond to the ODVA "AC Drive Speed/Torque" profile.

"Custom I/O Connection" provides a user-definable I/O process data set.

See also: [AC Drive Profile](#) [221](#)
 - b) Set data type to the corresponding value (SINT, INT, DINT).

The real data length of each object that is mapped in the I/O data is determined by the inverter OBD object.

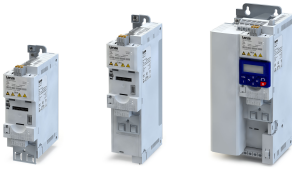

INT and SINT prevent an uneven data length.

DINT prevent an uneven number of data words.

The I/O configuration is now completed.

4. Change I/O mapping - Only in case of "Custom I/O Connection"!

1. Go to the line "Input" or "Output" and click "Change" to adapt the corresponding mapping individually.

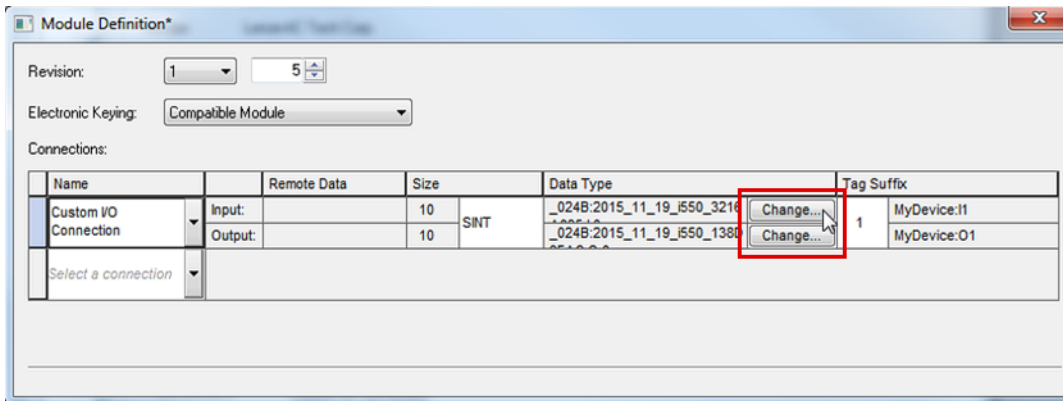

This example shows a mapping selection for inputs:

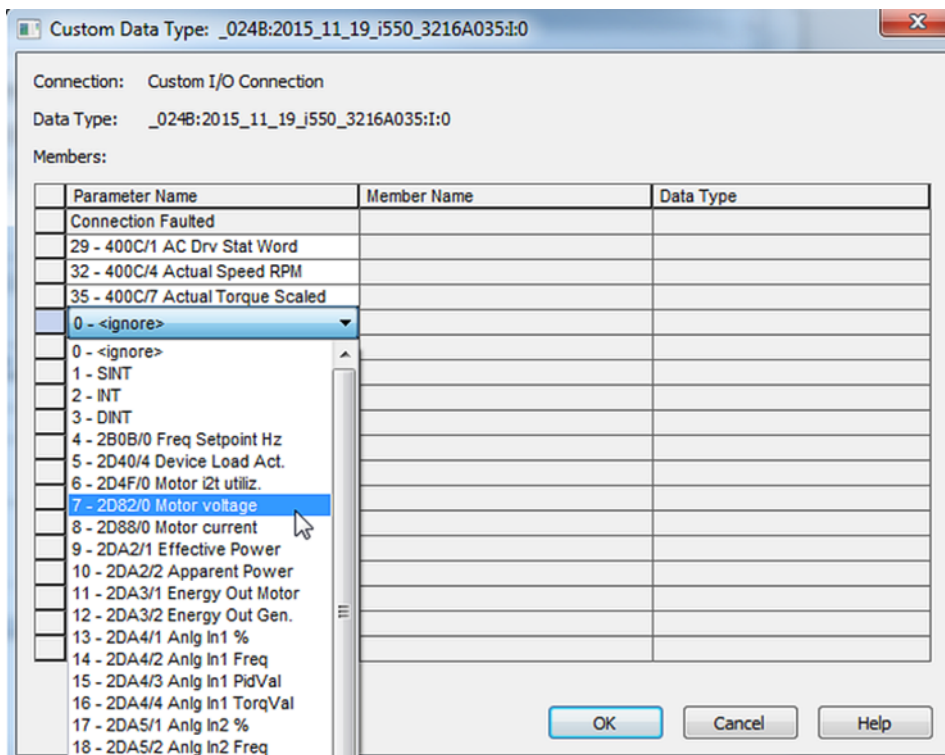

2. Group the process data according to their data length to prevent gaps.

Example:

1. All required DINT data
2. All required INT data
3. All required SINT data

At the end, a DINT value is automatically added to prevent tool zero-length problems.

Data types are provided according to the input or output data length.

Thus, e. g., no DINT type is provided at 10 bytes of input data:

Configuring the network

EtherNet/IP

Basic drive control via EtherNet/IP

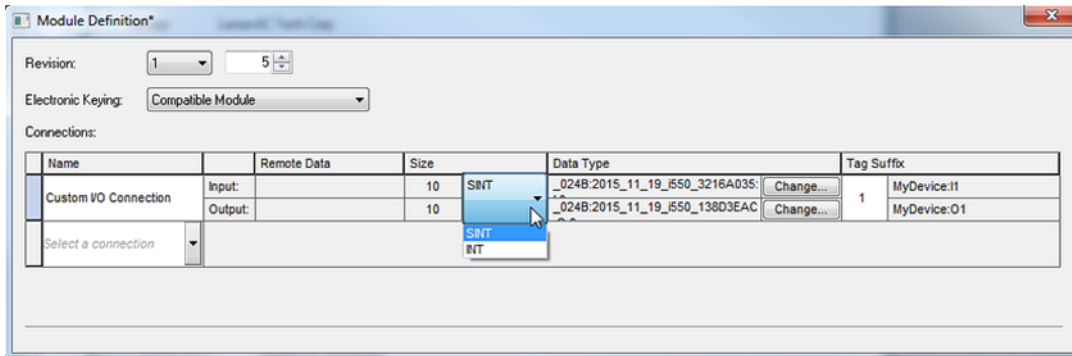

5. Configure data transfer.

1. Configure the cyclic data transfer (Implicit Messaging).

Further information: [▶ EtherNet/IP - cyclic data transfer](#) 298

2. Configure the acyclic data transfer (Explicit Messaging).

Further information: [▶ EtherNet/IP - acyclic data transfer](#) 301

The configuration of the data transfer is now completed.

6. »RSLogix™« project must be saved. Load configuration into the scanner.

1. »RSLogix™« project must be saved.

Click in the upper toolbar to "File" and execute the "Save" with a right-click.

If the project is saved for the first time, the "Save as" dialog window appears. Navigate to a folder, enter a file name and click "Save".

The configuration is saved in a file on your PC.

2. Load configuration into the scanner.

- a) Click in the upper toolbar to "Communications" and execute the "Download" with a right-click.

The "Download" dialog box is opened.

- b) Click "Download".

The configuration is loaded into the scanner.

When the download has been completed successfully, »RSLogix™« changes to the online mode and the I/O-OK field in the upper left area of the screen is green.

The configuration of the network is now completed.



8.9 Modbus TCP/IP



Modbus is an internationally approved, asynchronous, serial communication protocol, designed for commercial and industrial automation applications.

- Detailed information on the Modbus can be found on the web page of the international Modbus Organization, USA, who also further develop the Modbus protocol: <http://www.modbus.org>
- Information about the dimensioning of a Modbus network can be found in the configuration document for the inverter.

Preconditions

Control unit (CU) of the inverter is equipped with Modbus TCP.

8.9.1 Introduction

- The process of data transmission distinguishes between three different operating modes: Modbus ASCII, Modbus RTU and Modbus TCP. This chapter describes the Modbus TCP operating mode.
- The Modbus protocol is based on a master/slave architecture where the inverter always works as slave.
- The Modbus network only permits one master (at a time) sending commands and requests. The master is also the sole instance to be allowed to initiate Modbus communication. No direct communication takes place between the slaves.
- The network option supports the baud rates 10 Mbps (10 BaseT) and 100 Mbps (100 BaseT). The baud rate in the network is automatically detected.
- The inverter supports Modbus function codes 3, 6, 16 (0x10) and 23 (0x17).

8.9.2 Module specification

Properties and supported services	
Automatic detection of data rates (Auto-Negotiation)	✓
Baud rates	Half / full duplex, 10 Mbps, 100 Mbps
Maximum process data length per direction (Rx/Tx)	16 bytes
Parameter data channel	✓
Multicast messages	✓
Cycle time steps	4 ... 128 ms
Cycle time towards the axis	≤ 6 ms
Port-to-port latency	≤ 125 μs
ARP (Address Resolution Protocol, RFC 826)	✓
BOOTP (Bootstrap Protocol)	✓
DHCP (Dynamic Host Configuration Protocol)	✓
ICMP (Internet Control Messaging Protocol, RFC 792)	✓
IEEE 802.3 (Ethernet, RFC 894)	✓
IGMP (Internet Group Management Protocol)	V2
IP (Internet Protocol, RFC 791)	V4
TCP (Transmission Control Protocol, RFC 793)	✓
UDP (User Datagram Protocol, RFC 768)	✓
✓ Is supported.	

Configuring the network

Modbus TCP/IP
Configuration



8.9.3 Configuration

IP basic settings

The PC with the engineering software must be in the same network as the devices to be configured.

First, configure the PC so that this condition is fulfilled.

The required steps are described by the example of the operating system Microsoft® Windows® 7.

How to define the IP basic settings:

1. Call the "Mains and release center" under "System control".
2. Select "Change adapter settings" (observe administrator rights!).
3. Select the network to be configured (double-click), e. g.:

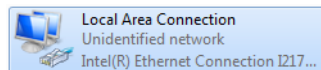

The network nodes (PLC, inverter) must be connected to the network.

The status dialog box of the network is opened.

4. Click "Properties".

The properties dialog box of the network is opened.

5. Select "Internet protocol version 4 (TCP/IPv4)" and click "Properties".

The properties dialog box of the "Internet protocol version 4 (TCP/IPv4)" is opened.

6. Enter the IP address, the subnet mask and, if required, the gateway address under "Use the following addresses".

7. Click "OK".

The IP basic settings are now completed.

Set IP address

The two rotary encoder switches at the front of the device serve to set the IP address in terms of hardware.

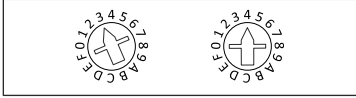
Setting	Addressing
0x00	IP address via the parameter 0x23B1:001 (P510.01) .
0x01 ... 0xFF	Setting of the 4th byte of the IP address via the rotary encoder switch. XXX.XXX.XXX.[setting] Example: Setting for the value 52 (3 × 16) + (4 × 1) = 52 

The value set via the rotary encoder switches is used when the mains is switched on or after a network restart with **0x23B0 (P508.00) = 1**. A changed value during operation will only become valid after the network has been restarted.

- **0x23B3 (P509.00)** shows the switch setting at the last mains connection.
- **0x23B2:001 (P511.01)** shows the active IP address.



Multicast setting



We recommend you to keep the standard settings in order to ensure a safe multicast transmission.

Multicast enables the transfer of data packages to several nodes or to a closed node group at the same time. For this purpose, the scanner automatically generates a multicast IP address for the device. The standard multicast TTL value (time to leave) is 1, which means that the multicast data packages are only transferred via the local subnetwork.

The multicast setting can also be made manually via the following parameter:

- **0x23A1:006 (P510.06):** Time-to-live value (TTL)

The parameters for configuring the network of the device are described below.

Parameter	Name / value range / [default setting]	Info
0x23B1:001 (P510.01)	Modbus -TCP/IP settings: IP address (MBTCP settings: IP address) 0 ... [276605120] ... 4294967295 • From version 04.00	Set IP address. The default setting 276605120 corresponds to the IP address 192.168.124.16. • 276605120 = 0x107CA8C0 → 0xC0.0xA8.0x7C.0x10 = 192.168.124.16
0x23B1:002 (P510.02)	Modbus -TCP/IP settings: Subnet (MBTCP settings: Subnet) 0 ... [16777215] ... 4294967295 • From version 04.00	Set subnet mask. The default setting 16777215 corresponds to the subnet mask 255.255.255.0. • 16777215 = 0xFFFFF → 0xFF.0xFF.0xFF.0x00 = 255.255.255.0
0x23B1:003 (P510.03)	Modbus -TCP/IP settings: Gateway (MBTCP settings: Gateway) 0 ... [0] ... 4294967295 • From version 04.00	Set gateway address. Example The setting 276344004 corresponds to the gateway address 196.172.120.16. • 276344004 = 0x1078ACC4 → 0xC4.0xAC.0x78.0x10 = 196.172.120.16
0x23B1:005 (P510.05)	Modbus -TCP/IP settings: IP configuration (MBTCP settings: IP configuration) • From version 04.00	Set IP configuration.
	0 Stored IP	The currently saved IP configuration is used.
	1 BOOTP	The IP configuration is assigned by the scanner via BOOTP.
	2 DHCP	The IP configuration is assigned by the Scanner via DHCP. The assignment of a gateway address that is not in the same subnetwork as the IP address, is denied.
0x23B1:006 (P510.06)	Modbus -TCP/IP settings: Time-to-live value (TTL) (MBTCP settings: TTL value) 1 ... [1] ... 255 • From version 04.00	Setting of the multicast TTL value for the validity of data packages in the network.
0x23B1:011 (P510.11)	Modbus -TCP/IP settings: Secondary port (MBTCP settings: Secondary port) 0 ... [502] ... 65535 • From version 04.00	Set port number for a second port.
0x23B4:001 (P512.01)	Port settings: Port 1 (Port settings: Port 1) • From version 04.00	Set baud rate for the port 1.
	0 Auto-Negotiation	
	1 10 Mbps	
	2 100 Mbps	
	5 10 Mbps/Half Duplex	
	6 10 Mbps/Full Duplex	
	7 100 Mbps/Half Duplex	
	8 100 Mbps/Full Duplex	

Configuring the network

Modbus TCP/IP
Time-out behaviour



Parameter	Name / value range / [default setting]	Info
0x23B4:002 (P512.02)	Port settings: Port 2 (Port settings: Port 2) • From version 04.00	Set baud rate for the port 2.
	0 Auto-Negotiation	
	1 10 Mbps	
	2 100 Mbps	
	5 10 Mbps/Half Duplex	
	6 10 Mbps/Full Duplex	
	7 100 Mbps/Half Duplex	
	8 100 Mbps/Full Duplex	
0x23B0 (P508.00)	Modbus TCP communication (MBTCP comm.) • From version 04.00	Restart / stop communication
	0 No action/no error	Only status feedback.
	1 Restart with current values	Restart communication in order that changed settings of the interface configuration become effective.
	2 Restart with default values	Restart communication with the standard values.
	5 Stop network communication	Stop communication.
	10 In progress	Only status feedback
	11 Action cancelled	
	12 Error	
0x23B3 (P509.00)	Switch position (Switch position) • Read only • From version 04.00	Display of the rotary encoder switch setting at the last mains power-on.

8.9.4 Time-out behaviour

The response to the missing Modbus messages can be configured via the following parameters.

Parameter	Name / value range / [default setting]	Info
0x23B1:010 (P510.10)	Modbus -TCP/IP settings: Ethernet time-out (MBTCP settings: Ethernet timeout) 500 ... [10000] ... 65535 ms • From version 04.00	Setting of the maximum permissible time-out of the TCP communication. When the specified monitoring time has elapsed, the response set in 0x2859:007 (P515.07) is triggered in the inverter.
0x23B6:001 (P514.01)	Time-out monitoring: Time-out time (MBTCP t-out mon: Time-out time) 0.0 ... [2.0] ... 300.0 s • From version 04.00	Monitoring is active if the first valid write command arrives at the Modbus master. Each further valid write/read message resets the watchdog timer. Monitoring responds if within the time set here no valid message has been received by the Modbus master.
0x23B6:002 (P514.02)	Time-out monitoring: Keep alive time-out time (MBTCP t-out mon: Keep al t-out) 0.0 ... [2.0] ... 300.0 s • From version 04.00	Monitoring is active after a valid value is written into the keep alive register 0x23B6:005 (P514.05) via the Modbus for the first time. Keep alive monitoring responds if no value (range 1 ... 65535) has been written into the keep alive register within the time set here.
0x23B6:005 (P514.05)	Time-out monitoring: Keep alive register (MBTCP t-out mon: Keep al register) 0 ... [0] ... 65535 • From version 04.00	Time-out monitoring of the keep alive register is active after a value has been written into the keep alive register for the first time. In order to prevent that time-out monitoring for the keep alive register responds, the keep alive register must be written as follows: • With a value of 1 ... 65535 and • an interval that is shorter than the time set in 0x23B6:002 (P514.02) .
0x2859:003 (P515.03)	Modbus TCP/IP monitoring: Configuration error (MBTCP monitoring: Config error) • From version 04.00 • For further possible settings, see parameter 0x2D45:001 (P310.01) . □ 196	Selection of the response triggered by the reception of invalid configuration data. Associated error code: • 33414 0x8286 - Network: PDO mapping error
	2 Trouble	▶ Error types □ 113



Configuring the network

Modbus TCP/IP
Time-out behaviour

Parameter	Name / value range / [default setting]	Info
0x2859:004 (P515.04)	Modbus TCP/IP monitoring: Initialisation error (MBTCP monitoring: Init error) <ul style="list-style-type: none"> From version 04.00 For further possible settings, see parameter 0x2D45:001 (P310.01). 196 	Selection of the response triggered by the occurrence of an error during the initialisation of the network component. Associated error code: <ul style="list-style-type: none"> 33170 0x8192 - Network: initialisation error
	2 Trouble	Error types 113
0x2859:007 (P515.07)	Modbus TCP/IP monitoring: Fault reaction by time-out Network (MBTCP monitoring: React t-out netw) <ul style="list-style-type: none"> From version 04.00 For further possible settings, see parameter 0x2D45:001 (P310.01). 196 	If monitoring detects a time-out of the TCP communication with an existing TCP connection, the error response to be selected with this parameter occurs. The maximum permissible time-out of the TCP communication is defined in 0x23B1:010 (P510.10) . Associated error code: <ul style="list-style-type: none"> 33044 0x8114 - Network: overall communication timeout
	1 Warning	Error types 113
0x2859:008 (P515.08)	Modbus TCP/IP monitoring: Fault reaction by time-out Master (MBTCP monitoring: React t-out mast) <ul style="list-style-type: none"> From version 04.00 For further possible settings, see parameter 0x2D45:001 (P310.01). 196 	Selection of the response if within the time set in 0x23B6:001 (P514.01) no valid message has arrived at the Modbus master. Associated error code: <ul style="list-style-type: none"> 33046 0x8116 - Modbus TCP master time-out
	3 Fault	Error types 113
0x2859:009 (P515.09)	Modbus TCP/IP monitoring: Fault reaction by time-out Keep alive (MBTCP monitoring: React t-out kp-al) <ul style="list-style-type: none"> From version 04.00 For further possible settings, see parameter 0x2D45:001 (P310.01). 196 	Selection of the response if within the time set in 0x23B6:002 (P514.02) no valid message has been written into the keep alive register. Associated error code: <ul style="list-style-type: none"> 33047 0x8117 - Modbus TCP Keep Alive time-out
	3 Fault	Error types 113

Configuring the network



Modbus TCP/IP
LED status displays





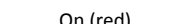
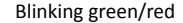

8.9.5 LED status displays

Information on the CIP status can be obtained quickly via the "MS" and "NS" LED displays on the front of the inverter. In addition, the LEDs at the RJ45 sockets indicate the Ethernet connection status.

The meaning of the "MS" and "NS" LEDs can be obtained from the following two tables.

LED "MS" (green/red)	CIP module status	Status/meaning
off	Nonexistent	The network option is not supplied with voltage.
 On (green)	Operational	The network option works correctly.
 Blinking green	Standby	The network option is not configured completely or the configuration is incorrect.
 Blinking red	Major recoverable fault	The network option contains a correctable error.
 On (red)	Major unrecoverable fault	The network option contains a non-correctable error.
 Blinking green/red	Device self testing	The network option executes a self-test.

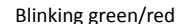
LED "NS" (green/red)	CIP network status	Status/meaning
off	No IP address	The network option is not supplied with voltage or has not received an IP address yet.
 On (green)	Connected	The network option works correctly and has established a connection to the scanner.
 Blinking green	No connections	The network option <ul style="list-style-type: none"> works correctly, has been assigned to an IP address, has not been implemented into the network yet by the scanner.
 Blinking red	Connection timeout	A time-out has occurred.
 On (red)	Duplicate IP	The network option cannot access the network (IP address conflict).
 Blinking green/red	Device self testing	The network option executes a self-test.

Status displays at the RJ45 sockets

The LEDs at the RJ45 sockets indicate the Ethernet connection status:

LED "Link" (green)	Status/meaning
off	No Ethernet connection.
 on	A physical Ethernet connection is available.

LED "Activity" (yellow)	Status/meaning
off	No Ethernet data transfer.
 on or flickers	Data is exchanged via Ethernet.

8.9.6 Diagnostics

The parameters for diagnosing the network are described below.

Parameter	Name / value range / [default setting]	Info
0x23B2:001 (P511.01)	Active Modbus TCP settings: Active IP address (Act. MBTCP sett.: Act. IP address) <ul style="list-style-type: none"> Read only From version 04.00 	Display of the active IP address.
0x23B2:002 (P511.02)	Active Modbus TCP settings: Active subnet (Act. MBTCP sett.: Act. subnet) <ul style="list-style-type: none"> Read only From version 04.00 	Display of the active subnet mask.



Configuring the network

Modbus TCP/IP
Diagnostics

Parameter	Name / value range / [default setting]	Info												
0x23B2:003 (P511.03)	Active Modbus TCP settings: Active gateway (Act. MBTCP sett.: Act. gateway) <ul style="list-style-type: none"> Read only From version 04.00 	Display of the active gateway address. Example The setting 276344004 corresponds to the gateway address 196.172.120.16. <ul style="list-style-type: none"> 276344004 = 0x1078ACC4 → 0xC4.0xAC.0x78.0x10 = 196.172.120.16 												
0x23B2:005 (P511.05)	Active Modbus TCP settings: MAC address (Act. MBTCP sett.: MAC address) <ul style="list-style-type: none"> Read only From version 04.00 	Display of the active MAC address.												
0x23B3 (P509.00)	Switch position (Switch position) <ul style="list-style-type: none"> Read only From version 04.00 	Display of the rotary encoder switch setting at the last mains power-on.												
0x23B5:001 (P513.01)	Active port settings: Port 1 (Act. port sett.: Port 1) <ul style="list-style-type: none"> Read only From version 04.00 <table border="1"> <tr><td>0</td><td>Not connected</td></tr> <tr><td>1</td><td>10 Mbps/Half Duplex</td></tr> <tr><td>2</td><td>10 Mbps/Full Duplex</td></tr> <tr><td>3</td><td>100 Mbps/Half Duplex</td></tr> <tr><td>4</td><td>100 Mbps/Full Duplex</td></tr> </table>	0	Not connected	1	10 Mbps/Half Duplex	2	10 Mbps/Full Duplex	3	100 Mbps/Half Duplex	4	100 Mbps/Full Duplex	Display of the baud rate set for the port 1 in parameter 0x23B4:001 (P512.01) .		
0	Not connected													
1	10 Mbps/Half Duplex													
2	10 Mbps/Full Duplex													
3	100 Mbps/Half Duplex													
4	100 Mbps/Full Duplex													
0x23B5:002 (P513.02)	Active port settings: Port 2 (Act. port sett.: Port 2) <ul style="list-style-type: none"> Read only From version 04.00 <table border="1"> <tr><td>0</td><td>Not connected</td></tr> <tr><td>1</td><td>10 Mbps/Half Duplex</td></tr> <tr><td>2</td><td>10 Mbps/Full Duplex</td></tr> <tr><td>3</td><td>100 Mbps/Half Duplex</td></tr> <tr><td>4</td><td>100 Mbps/Full Duplex</td></tr> </table>	0	Not connected	1	10 Mbps/Half Duplex	2	10 Mbps/Full Duplex	3	100 Mbps/Half Duplex	4	100 Mbps/Full Duplex	Display of the baud rate set for the port 2 in parameter 0x23B4:002 (P512.02) .		
0	Not connected													
1	10 Mbps/Half Duplex													
2	10 Mbps/Full Duplex													
3	100 Mbps/Half Duplex													
4	100 Mbps/Full Duplex													
0x23B8 (P516.00)	Modbus TCP module status (MBTCP modul. stat) <ul style="list-style-type: none"> Read only From version 04.00 <table border="1"> <tr><td>0</td><td>Power off</td></tr> <tr><td>1</td><td>Initialization</td></tr> <tr><td>2</td><td>Warning</td></tr> <tr><td>3</td><td>Fault</td></tr> <tr><td>4</td><td>No configuration</td></tr> <tr><td>5</td><td>Operational</td></tr> </table>	0	Power off	1	Initialization	2	Warning	3	Fault	4	No configuration	5	Operational	Display of the TCP module state.
0	Power off													
1	Initialization													
2	Warning													
3	Fault													
4	No configuration													
5	Operational													
0x23B9 (P517.00)	Modbus TCP/IP network status (MBTCP netw stat) <ul style="list-style-type: none"> Read only From version 04.00 <table border="1"> <tr><td>0</td><td>No configuration</td></tr> <tr><td>1</td><td>Initialization</td></tr> <tr><td>2</td><td>Connection time-out</td></tr> <tr><td>3</td><td>Configuration error</td></tr> <tr><td>4</td><td>Not connected</td></tr> <tr><td>5</td><td>Connection established</td></tr> </table>	0	No configuration	1	Initialization	2	Connection time-out	3	Configuration error	4	Not connected	5	Connection established	Display of the active network status.
0	No configuration													
1	Initialization													
2	Connection time-out													
3	Configuration error													
4	Not connected													
5	Connection established													
0x23BA:001 (P580.01)	Modbus TCP statistics: Messages received (MBTCP statistics: Rx messages) <ul style="list-style-type: none"> Read only From version 04.00 	Display of the total number of messages received. <ul style="list-style-type: none"> This counter counts both valid and invalid messages. After the maximum value has been reached, the counter starts again "0". 												
0x23BA:002 (P580.02)	Modbus TCP statistics: Valid messages received (MBTCP statistics: Valid Rx messag.) <ul style="list-style-type: none"> Read only From version 04.00 	Display of the number of valid messages received. <ul style="list-style-type: none"> After the maximum value has been reached, the counter starts again "0". 												

Configuring the network

Modbus TCP/IP
Diagnostics



Parameter	Name / value range / [default setting]	Info
0x23BA:003 (P580.03)	Modbus TCP statistics: Messages with exceptions (MBTCP statistics: Mess. w. except) <ul style="list-style-type: none"> • Read only • From version 04.00 	Display of the number of messages with exceptions that have been received. <ul style="list-style-type: none"> • After the maximum value has been reached, the counter starts again "0".
0x23BA:005 (P580.05)	Modbus TCP statistics: Messages sent (MBTCP statistics: Tx messages) <ul style="list-style-type: none"> • Read only • From version 04.00 	Display of the total number of messages sent. <ul style="list-style-type: none"> • After the maximum value has been reached, the counter starts again "0".
0x23BE:001 (P585.01)	Modbus TCP/IP diagnostics of last Rx/Tx data: Offset (MBTCP Tx/Rx diag: Rx offset) 0 ... [0] ... 240 <ul style="list-style-type: none"> • From version 04.00 	For diagnostic purposes, the last received message (max. 16 bytes) is displayed in 0x23BE:002 (P585.02) . For longer messages, an offset can be specified here, indicating from which byte of the message the display of the 16 bytes is to start.
0x23BE:002 (P585.02)	Modbus TCP/IP diagnostics of last Rx/Tx data: Last Rx message (MBTCP Tx/Rx diag: Last Rx message) <ul style="list-style-type: none"> • Read only • From version 04.00 	Display of the message received last.
0x23BE:003 (P585.03)	Modbus TCP/IP diagnostics of last Rx/Tx data: Offset (MBTCP Tx/Rx diag: Tx offset) 0 ... [0] ... 240 <ul style="list-style-type: none"> • From version 04.00 	For diagnostic purposes, the last sent message (max. 16 bytes) is displayed in 0x23BE:004 (P585.04) . For longer messages, an offset can be specified here, indicating from which byte of the message the display of the 16 bytes is to start.
0x23BE:004 (P585.04)	Modbus TCP/IP diagnostics of last Rx/Tx data: Last Tx message (MBTCP Tx/Rx diag: Last Tx message) <ul style="list-style-type: none"> • Read only • From version 04.00 	Display of the message sent last.
0x23B1:005 (P510.05)	Modbus -TCP/IP settings: IP configuration (MBTCP settings: IP configuration) <ul style="list-style-type: none"> • From version 04.00 	Set IP configuration.
	0 Stored IP	The currently saved IP configuration is used.
	1 BOOTP	The IP configuration is assigned by the scanner via BOOTP.
	2 DHCP	The IP configuration is assigned by the Scanner via DHCP. The assignment of a gateway address that is not in the same subnetwork as the IP address, is denied.



8.9.7 Modbus function codes

The mode of access to inverter data (parameters) is controlled via function codes.

Telegram structure

Communication is established on the basis of the master/slave mode. Communication is always started by a master request. The inverter (slave) then either gives a valid response or outputs an error code (provided that the request has been received and evaluated as valid message. Error causes can be invalid CRC checksums, non-supported function codes or impermissible data accesses.

The ADU contains the elements required for communication:

- For slave address (2 bytes) within the header, see [Configuration](#) [310](#)
- Function code
- Register address
 - The function codes listed above exclusively refer to "4X registers", i. e. registers from the address 4000 onwards.
 - All data in the inverter can only be accessed via these 4X registers.
 - The 4xxx reference is implicit, i. e. given by the function code used. In the frame therefore the leading 4 is omitted in the addressing process.
 - The numbering of the registers starts with 1; addressing, however, starts with 0. Therefore, for instance, the address 0 is used in the frame when register 40001 is read.
- For data, see [Data mapping](#) [322](#)
- Error code
- Checksum

The data are represented in Big Endian format (most significant byte first).

ADU (Application Data Unit)				
Header (incl. address)	Function code	Register address	Data / error code	Checksum (CRC)
7 bytes	1 byte	2 bytes	2 bytes	4 bytes

Function code

The inverter supports the following function codes:

Function code	Function name	INFO
3	Read Holding Registers	Reading of a single register or a group of several interconnected registers.
6	Preset Single Register	Writing of a single register.
16	Preset Multiple Registers	Writing of a single register or a group of several interconnected registers.
23	Read/Write 4X Registers	Reading and writing within a transaction: <ul style="list-style-type: none"> • Writing of a data block into a group of several interconnected registers. • Reading from a block of interconnected registers.

Configuring the network

Modbus TCP/IP
Modbus function codes



Error codes

Error code	Name	Cause(s)
0x01	Invalid function code	The function code is not supported by the inverter, or the inverter is in a state in which the request is not permissible or in which it cannot be processed.
0x02	Invalid data address	The combination of a start address and the length of the data to be transmitted is invalid. Example: If you have a slave with 100 registers, the first register has the address 0 and the last register has the address 99. If there is a request of four registers now, from the start address 96, the request can be processed successfully (for registers 96, 97, 98, and 99). If, however, five registers from the start address 96 are queried, this error code is returned, since the slave has no register with the address 100.
0x03	Invalid data value	Error in the reset structure of a complex request, e. g. because the data length that has resulted implicitly is not correct. The cause, however, is not that a (parameter) value is written outside the valid setting range. As a matter of principle, the Modbus protocol has no information on valid setting ranges of single registers or their meaning.
0x04	Slave device failure	A non-correctable error has occurred while the request was processed in the inverter.
0x06	Server is busy	The master could not accept the request of the client. If necessary, the client must transmit the message to the master again at a later date.

Data transfer with function code 3

Request	
Function code	0x03
Start address	0x0000 ... 0xFFFF
Number of registers (n)	0x01 ... 0x7D (1 ... 125)
Response	
Function code	0x03
Byte counter	2 x (n)
Register value	Data in (n) register of 2 bytes each
Error message	
Error code	0x83
Exception code	01 ... 04

Example for data transfer with function code 3

The data from the registers 40108 to 40110 are to be read.

Request		INFO
Function code	0x03	Function code 3
Start address (High)	0x00	Start address 107 (0x006B)
Start address (Low)	0x6B	
Number of registers (High)	0x00	Number of registers = 3 (0x0003)
Number of registers (Low)	0x03	
Response		INFO
Function code	0x03	Function code 3
Byte counter	0x06	6 bytes are read.
Value in registers 40108 (High)	0x02	Data: 0x022B (555).
Value in registers 40108 (Low)	0x2B	
Value in registers 40109 (High)	0x00	Data: 0x0000 (0).
Value in registers 40109 (Low)	0x00	
Value in registers 40110 (High)	0x00	Data: 0x0064 (100).
Value in registers 40110 (Low)	0x64	



Data transfer with function code 6

Request	
Function code	0x06
Register address	0x0000 ... 0xFFFF
Register value	0x0000 ... 0xFFFF
Response	
Function code	0x06
Register address	0x0000 ... 0xFFFF
Register value	0x0000 ... 0xFFFF
Error message	
Error code	0x86
Exception code	01 ... 04

Example for data transfer with function code 6

The value "3" (0x0003) is to be written into the register 40002.

Request		INFO
Function code	0x06	Function code 6
Register address (High)	0x00	Register address: 1 (0x0001)
Register address (Low)	0x01	
Register value (High)	0x00	Register value: 3 (0x0003)
Register value (Low)	0x03	
Response		INFO
Function code	0x06	Function code 6
Register address (High)	0x00	Register address: 1 (0x0001)
Register address (Low)	0x01	
Register value (High)	0x00	Register value: 3 (0x0003)
Register value (Low)	0x03	

Data transfer with function code 16

Request	
Function code	0x10
Start address	0x0000 ... 0xFFFF
Number of registers (n)	0x0001 ... 0x7D (0d125)
Byte counter	2 x (n)
Register value(s)	Data in (n) register of 2 bytes each
Response	
Function code	0x10
Byte counter	2 x (number of registers)
Register value	Data in (n) register of 2 bytes each
Error message	
Error code	0x90
Exception code	01 ... 04

Configuring the network

Modbus TCP/IP
Modbus function codes



Example for data transfer with function code 16

The value "10" is to be written into the register 40002 and the value "258" is to be written into the register 40003.

Request		INFO
Function code	0x10	Function code 16
Start address (High)	0x00	Start address: 1 (0x0001)
Start address (Low)	0x01	
Number of registers (High)	0x00	Number of registers: 2 (0x0002)
Number of registers (Low)	0x02	
Byte counter	0x04	4 bytes (0x0004) are to be written.
Register value (High)	0x00	The value "10" (0x000A) is written into the register with the start address 1 (= register 40002).
Register value (Low)	0x0A	
Register value (High)	0x01	The value "258" (0x0102) is written into the following register (= register 40003).
Register value (Low)	0x02	

Response		INFO
Function code	0x10	Function code 16
Start address (High)	0x00	Start address: 1 (0x0001)
Start address (Low)	0x01	
Number of registers (High)	0x00	Number of registers: 2 (0x0002)
Number of registers (Low)	0x02	

Data transfer with function code 23

Request	
Function code	0x17
Start address for reading (High)	0x0000 ... 0xFFFF
Start address for reading (Low)	0x0000 ... 0xFFFF
Number of registers for reading (High)	0x00 ... 0xFF
Number of registers for reading (Low)	0x00 ... 0xFF
Start address for writing (High)	0x0000 ... 0xFFFF
Start address for writing (Low)	0x0000 ... 0xFFFF
Number of registers for writing (High)	0x00 ... 0xFF
Number of registers for writing (Low)	0x00 ... 0xFF
Byte counter	2 x (number of registers)
Written value 1 (High)	0x00 ... 0xFF
Written value 1 (Low)	0x00 ... 0xFF
...	...
Written value n (High)	0x00 ... 0xFF
Written value n (Low)	0x00 ... 0xFF

Response	
Function code	0x17
Byte counter	2 x (number of registers)
Read value 1 (High)	0x00 ... 0xFF
Read value 1 (Low)	0x00 ... 0xFF
...	...
Read value x (High)	0x00 ... 0xFF
Read value x (Low)	0x00 ... 0xFF

Error message	
Error code	0x97
Exception code	02 ... 04



Example for data transfer with function code 23

The following tasks are to be executed with a transaction:

- The values from 6 registers, starting with register 40005, are to be read.
- The value "255" is to be written into each of the 3 registers, starting with register 40016.

Request		INFO
Function code	0x17	Function code 23
Start address for reading (High)	0x00	Start address for reading: 4 (0x0004)
Start address for reading (Low)	0x04	
Number of registers for reading (High)	0x00	Number of registers for reading: 6 (0x0006)
Number of registers for reading (Low)	0x06	
Start address for writing (High)	0x00	Start address for writing: 15 (0x000F)
Start address for writing (Low)	0x0F	
Number of registers for writing (High)	0x00	Number of registers for writing: 3 (0x0003)
Number of registers for writing (Low)	0x03	
Byte counter	0x06	6 bytes (0x06) must be provided in 3 registers.
Written value 1 (High)	0x00	Data: 255 (0x00FF)
Written value 1 (Low)	0xFF	
Written value 2 (High)	0x00	Data: 255 (0x00FF)
Written value 2 (Low)	0xFF	
Written value 3 (High)	0x00	Data: 255 (0x00FF)
Written value 3 (Low)	0xFF	

Response		INFO
Function code	0x17	Function code 23
Byte counter	0x0C	12 bytes (0x0C) from 6 registers are read.
Read value 1 (High)	0x00	1. written value Data: 254 (0x00FE)
Read value 1 (Low)	0xFE	
Written value 2 (High)	0x0A	2. written value Data: 2765 (0x0ACD)
Read value 2 (Low)	0xCD	
Read value 3 (High)	0x00	3. read value Data: 1 (0x0001)
Read value 3 (Low)	0x01	
Read value 4 (High)	0x00	4. read value Data: 3 (0x0003)
Read value 4 (Low)	0x03	
Read value 5 (High)	0x00	5. read value Data: 13 (0x000D)
Read value 5 (Low)	0x0D	
Read value 6 (High)	0x00	6. read value Data: 255 (0x00FF)
Read value 6 (Low)	0xFF	

Configuring the network

Modbus TCP/IP
Data mapping

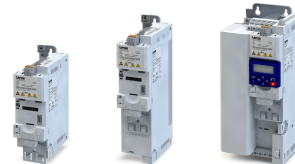

8.9.8 Data mapping

The process of data mapping is used for defining which Modbus registers read or write to which inverter parameters.

Overview

The following table provides an overview of the Modbus register with variable and permanent assignment:

Register	Register address	Parameter
40103	0102	Variable mapping Parameters from 0x23BB:001 (P530.01) to 0x23BB:024 (P530.24)
40104	0103	
...	...	
40149	0148	
42001	2000	Permanently defined Modbus status parameters Parameters from to
...	...	
42021	2020	
42101	2100	Permanently defined Modbus control parameters Parameters from to
...	...	
42121	2120	

Details

- There are fixedly defined Modbus registers for common control and status words, which are located in coherent blocks, in order to facilitate communication with OPC servers and other Modbus masters. In order to access all relevant data of the inverter, only a minimum number of commands is required.
- In addition, 24 registers are provided for variable mapping, i. e. free assignment to inverter parameters.

Predefined Modbus control registers

- These registers are provided with write and read access.
- The cross-reference in column 2 leads to the detailed parameter description.

Modbus registers	Permanently assigned parameter	
	Address	Name
42101	0x400B:001 (P592.01)	AC Drive control word
42102	0x400B:005 (P592.05)	Network setpoint frequency (0.01)
42103	0x4008:002 (P590.02)	NetWordIN2
42104	0x4008:003 (P590.03)	NetWordIN3
42105	0x400B:007 (P592.07)	PID setpoint
42106	0x6071	Target torque
42107	0x4008:001 (P590.01)	NetWordIN1
42108	0x4008:004 (P590.04)	NetWordIN4
42109 ... 42121	-	Reserved



Predefined Modbus status registers

- These registers are only provided with read access.
- The cross-reference in column 2 leads to the detailed parameter description.

Modbus registers	Permanently assigned parameter	
	Address	Name
42001	0x400C:001 (P593.01)	AC Drive status word
42002	0x400C:006 (P593.06)	Frequency (0.01)
42003	0x603F (P150.00)	Error code
42004	0x400C:005 (P593.05)	Drive status
42005	0x2D89 (P106.00)	Motor voltage
42006	0x2D88 (P104.00)	Motor current
42007	0x6078 (P103.00)	Current actual value
42008	0x2DA2:002 (P108.02)	Apparent power (42008 = High Word, 42009 = Low Word)
42009		
42010	0x2D84:001 (P117.01)	Heatsink temperature
42011	0x2D87 (P105.00)	DC-bus voltage
42012	0x60FD (P118.00)	Digital inputs (only bit 16 ... bit 31)
42013	0x6077 (P107.00)	Torque actual value
42014 ... 42021	-	Reserved

Variable mapping

- Via [0x23BB:001 \(P530.01\)](#) ... [0x23BB:024 \(P530.24\)](#), 24 registers can be mapped variably to parameters of the inverter.
Format: 0xiiiiiss00 (iiii = index, ss = subindex)
- The display of the internal Modbus register numbers in [0x23BC:001 \(P531.01\)](#) ... [0x23BC:024 \(P531.24\)](#) is generated automatically. Since 32-bit parameters require two registers, there is no 1:1 assignment.
- For the mappable registers, a CRC (Cyclic Redundancy Check) is executed. The checksum determined is displayed in [0x23BD \(P532.00\)](#). The user can read this "validation code" and use it for comparison in the Modbus master. In this way it can be checked whether the inverter currently queried is configured correctly for the respective application.

Configuring the network

Modbus TCP/IP Data mapping

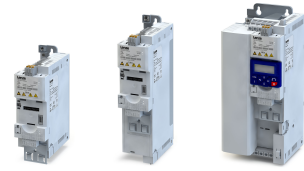

Parameter	Name / value range / [default setting]	Info
0x23BB:001 (P530.01)	Modbus TCP/IP parameter mapping: Parameter 1 (MBTCP param.mapp: Parameter 1) 0x00000000 ... [0x00000000] ... 0xFFFFFFFF	
0x23BB:002 (P530.02)	Modbus TCP/IP parameter mapping: Parameter 2 (MBTCP param.mapp: Parameter 2) 0x00000000 ... [0x00000000] ... 0xFFFFFFFF	
0x23BB:003 (P530.03)	Modbus TCP/IP parameter mapping: Parameter 3 (MBTCP param.mapp: Parameter 3) 0x00000000 ... [0x00000000] ... 0xFFFFFFFF	
0x23BB:004 (P530.04)	Modbus TCP/IP parameter mapping: Parameter 4 (MBTCP param.mapp: Parameter 4) 0x00000000 ... [0x00000000] ... 0xFFFFFFFF	
0x23BB:005 (P530.05)	Modbus TCP/IP parameter mapping: Parameter 5 (MBTCP param.mapp: Parameter 5) 0x00000000 ... [0x00000000] ... 0xFFFFFFFF	
0x23BB:006 (P530.06)	Modbus TCP/IP parameter mapping: Parameter 6 (MBTCP param.mapp: Parameter 6) 0x00000000 ... [0x00000000] ... 0xFFFFFFFF	
0x23BB:007 (P530.07)	Modbus TCP/IP parameter mapping: Parameter 7 (MBTCP param.mapp: Parameter 7) 0x00000000 ... [0x00000000] ... 0xFFFFFFFF	
0x23BB:008 (P530.08)	Modbus TCP/IP parameter mapping: Parameter 8 (MBTCP param.mapp: Parameter 8) 0x00000000 ... [0x00000000] ... 0xFFFFFFFF	
0x23BB:009 (P530.09)	Modbus TCP/IP parameter mapping: Parameter 9 (MBTCP param.mapp: Parameter 9) 0x00000000 ... [0x00000000] ... 0xFFFFFFFF	
0x23BB:010 (P530.10)	Modbus TCP/IP parameter mapping: Parameter 10 (MBTCP param.mapp: Parameter 10) 0x00000000 ... [0x00000000] ... 0xFFFFFFFF	
0x23BB:011 (P530.11)	Modbus TCP/IP parameter mapping: Parameter 11 (MBTCP param.mapp: Parameter 11) 0x00000000 ... [0x00000000] ... 0xFFFFFFFF	
0x23BB:012 (P530.12)	Modbus TCP/IP parameter mapping: Parameter 12 (MBTCP param.mapp: Parameter 12) 0x00000000 ... [0x00000000] ... 0xFFFFFFFF	
0x23BB:013 (P530.13)	Modbus TCP/IP parameter mapping: Parameter 13 (MBTCP param.mapp: Parameter 13) 0x00000000 ... [0x00000000] ... 0xFFFFFFFF	
0x23BB:014 (P530.14)	Modbus TCP/IP parameter mapping: Parameter 14 (MBTCP param.mapp: Parameter 14) 0x00000000 ... [0x00000000] ... 0xFFFFFFFF	
0x23BB:015 (P530.15)	Modbus TCP/IP parameter mapping: Parameter 15 (MBTCP param.mapp: Parameter 15) 0x00000000 ... [0x00000000] ... 0xFFFFFFFF	
0x23BB:016 (P530.16)	Modbus TCP/IP parameter mapping: Parameter 16 (MBTCP param.mapp: Parameter 16) 0x00000000 ... [0x00000000] ... 0xFFFFFFFF	
0x23BB:017 (P530.17)	Modbus TCP/IP parameter mapping: Parameter 17 (MBTCP param.mapp: Parameter 17) 0x00000000 ... [0x00000000] ... 0xFFFFFFFF	
0x23BB:018 (P530.18)	Modbus TCP/IP parameter mapping: Parameter 18 (MBTCP param.mapp: Parameter 18) 0x00000000 ... [0x00000000] ... 0xFFFFFFFF	
0x23BB:019 (P530.19)	Modbus TCP/IP parameter mapping: Parameter 19 (MBTCP param.mapp: Parameter 19) 0x00000000 ... [0x00000000] ... 0xFFFFFFFF	
0x23BB:020 (P530.20)	Modbus TCP/IP parameter mapping: Parameter 20 (MBTCP param.mapp: Parameter 20) 0x00000000 ... [0x00000000] ... 0xFFFFFFFF	
0x23BB:021 (P530.21)	Modbus TCP/IP parameter mapping: Parameter 21 (MBTCP param.mapp: Parameter 21) 0x00000000 ... [0x00000000] ... 0xFFFFFFFF	



Configuring the network

Modbus TCP/IP Data mapping

Parameter	Name / value range / [default setting]	Info
0x23BB:022 (P530.22)	Modbus TCP/IP parameter mapping: Parameter 22 (MBTCP param.mapp: Parameter 22) 0x00000000 ... [0x00000000] ... 0xFFFFFFFF	
0x23BB:023 (P530.23)	Modbus TCP/IP parameter mapping: Parameter 23 (MBTCP param.mapp: Parameter 23) 0x00000000 ... [0x00000000] ... 0xFFFFFFFF	
0x23BB:024 (P530.24)	Modbus TCP/IP parameter mapping: Parameter 24 (MBTCP param.mapp: Parameter 24) 0x00000000 ... [0x00000000] ... 0xFFFFFFFF	
0x23BC:001 (P531.01)	Register assignment: Register 1 (Register assignm: Register 1) • Read only	Display of the internal Modbus register number starting from which the parameter mapped in 0x23BB:1 is stored. • For the first parameter mapped, always 2500.
0x23BC:002 (P531.02)	Register assignment: Register 2 (Register assignm: Register 2) • Read only	Display of the internal Modbus register number starting from which the parameter mapped in 0x23BB:2 is stored. • 2500 + offset. The offset results from the data types of the previously mapped parameters.
0x23BC:003 (P531.03)	Register assignment: Register 3 (Register assignm: Register 3) • Read only	Display of the internal Modbus register number starting from which the parameter mapped in 0x23BB:3 is stored. • 2500 + offset. The offset results from the data types of the previously mapped parameters.
0x23BC:004 (P531.04)	Register assignment: Register 4 (Register assignm: Register 4) • Read only	Display of the internal Modbus register number starting from which the parameter mapped in 0x23BB:4 is stored. • 2500 + offset. The offset results from the data types of the previously mapped parameters.
0x23BC:005 (P531.05)	Register assignment: Register 5 (Register assignm: Register 5) • Read only	Display of the internal Modbus register number starting from which the parameter mapped in 0x23BB:5 is stored. • 2500 + offset. The offset results from the data types of the previously mapped parameters.
0x23BC:006 (P531.06)	Register assignment: Register 6 (Register assignm: Register 6) • Read only	Display of the internal Modbus register number starting from which the parameter mapped in 0x23BB:6 is stored. • 2500 + offset. The offset results from the data types of the previously mapped parameters.
0x23BC:007 (P531.07)	Register assignment: Register 7 (Register assignm: Register 7) • Read only	Display of the internal Modbus register number starting from which the parameter mapped in 0x23BB:7 is stored. • 2500 + offset. The offset results from the data types of the previously mapped parameters.
0x23BC:008 (P531.08)	Register assignment: Register 8 (Register assignm: Register 8) • Read only	Display of the internal Modbus register number starting from which the parameter mapped in 0x23BB:8 is stored. • 2500 + offset. The offset results from the data types of the previously mapped parameters.
0x23BC:009 (P531.09)	Register assignment: Register 9 (Register assignm: Register 9) • Read only	Display of the internal Modbus register number starting from which the parameter mapped in 0x23BB:9 is stored. • 2500 + offset. The offset results from the data types of the previously mapped parameters.
0x23BC:010 (P531.10)	Register assignment: Register 10 (Register assignm: Register 10) • Read only	Display of the internal Modbus register number starting from which the parameter mapped in 0x23BB:10 is stored. • 2500 + offset. The offset results from the data types of the previously mapped parameters.
0x23BC:011 (P531.11)	Register assignment: Register 11 (Register assignm: Register 11) • Read only	Display of the internal Modbus register number starting from which the parameter mapped in 0x23BB:11 is stored. • 2500 + offset. The offset results from the data types of the previously mapped parameters.
0x23BC:012 (P531.12)	Register assignment: Register 12 (Register assignm: Register 12) • Read only	Display of the internal Modbus register number starting from which the parameter mapped in 0x23BB:12 is stored. • 2500 + offset. The offset results from the data types of the previously mapped parameters.
0x23BC:013 (P531.13)	Register assignment: Register 13 (Register assignm: Register 13) • Read only	Display of the internal Modbus register number starting from which the parameter mapped in 0x23BB:13 is stored. • 2500 + offset. The offset results from the data types of the previously mapped parameters.

Configuring the network

Modbus TCP/IP
Data mapping



Parameter	Name / value range / [default setting]	Info
0x23BC:014 (P531.14)	Register assignment: Register 14 (Register assignm: Register 14) • Read only	Display of the internal Modbus register number starting from which the parameter mapped in 0x23BB:14 is stored. • 2500 + offset. The offset results from the data types of the previously mapped parameters.
0x23BC:015 (P531.15)	Register assignment: Register 15 (Register assignm: Register 15) • Read only	Display of the internal Modbus register number starting from which the parameter mapped in 0x23BB:15 is stored. • 2500 + offset. The offset results from the data types of the previously mapped parameters.
0x23BC:016 (P531.16)	Register assignment: Register 16 (Register assignm: Register 16) • Read only	Display of the internal Modbus register number starting from which the parameter mapped in 0x23BB:16 is stored. • 2500 + offset. The offset results from the data types of the previously mapped parameters.
0x23BC:017 (P531.17)	Register assignment: Register 17 (Register assignm: Register 17) • Read only	Display of the internal Modbus register number starting from which the parameter mapped in 0x23BB:17 is stored. • 2500 + offset. The offset results from the data types of the previously mapped parameters.
0x23BC:018 (P531.18)	Register assignment: Register 18 (Register assignm: Register 18) • Read only	Display of the internal Modbus register number starting from which the parameter mapped in 0x23BB:18 is stored. • 2500 + offset. The offset results from the data types of the previously mapped parameters.
0x23BC:019 (P531.19)	Register assignment: Register 19 (Register assignm: Register 19) • Read only	Display of the internal Modbus register number starting from which the parameter mapped in 0x23BB:19 is stored. • 2500 + offset. The offset results from the data types of the previously mapped parameters.
0x23BC:020 (P531.20)	Register assignment: Register 20 (Register assignm: Register 20) • Read only	Display of the internal Modbus register number starting from which the parameter mapped in 0x23BB:20 is stored. • 2500 + offset. The offset results from the data types of the previously mapped parameters.
0x23BC:021 (P531.21)	Register assignment: Register 21 (Register assignm: Register 21) • Read only	Display of the internal Modbus register number starting from which the parameter mapped in 0x23BB:21 is stored. • 2500 + offset. The offset results from the data types of the previously mapped parameters.
0x23BC:022 (P531.22)	Register assignment: Register 22 (Register assignm: Register 22) • Read only	Display of the internal Modbus register number starting from which the parameter mapped in 0x23BB:22 is stored. • 2500 + offset. The offset results from the data types of the previously mapped parameters.
0x23BC:023 (P531.23)	Register assignment: Register 23 (Register assignm: Register 23) • Read only	Display of the internal Modbus register number starting from which the parameter mapped in 0x23BB:23 is stored. • 2500 + offset. The offset results from the data types of the previously mapped parameters.
0x23BC:024 (P531.24)	Register assignment: Register 24 (Register assignm: Register 24) • Read only	Display of the internal Modbus register number starting from which the parameter mapped in 0x23BB:24 is stored. • 2500 + offset. The offset results from the data types of the previously mapped parameters.
0x23BD (P532.00)	Verification code (Verificat. code) • Read only • From version 04.00	



8.9.9 Commissioning

In the following, the steps required for controlling the inverter via Modbus are described.

Parameterisation required

1. Activate network control: [0x2631:037 \(P400.37\)](#) = "TRUE [1]"
2. Set network as standard setpoint source: [0x2860:001 \(P201.01\)](#) = "Network [5]"
3. Set IP address of the inverter (slave), see section Data mapping. [322](#)
4. Set the Modbus baud rate and the operating mode for both Ethernet ports.
 - Set baud rate/ operating mode for the port 1 in: [0x23B4:001 \(P512.01\)](#).
 - Set baud rate/ operating mode for the port 2 in: [0x23B4:002 \(P512.02\)](#).



In the default setting, the digital input DI1 is assigned with the "Run" function. If the network control is activated, this function serves as "start enable" for start commands via network. Hence, the digital input DI1 must be set to HIGH level in order that the motor can be started via network. [▶ Start / stop motor 499](#)

Starting/stopping the drive via Modbus

For starting/stopping the drive, Modbus register 42101 can be used.

- Modbus register 42101 is permanently assigned to the AC Drive control word [0x400B:001 \(P592.01\)](#).
- In the frame, the leading 4 is omitted in the addressing process. The numbering of the registers starts with 1; addressing, however starts with 0. Therefore the address 2100 (0x0834) is used in the frame when register 42101 is written.

Bits set in the AC drive control word:

- Bit 0 ≡ Run forward (CW)
- Bit 5 ≡ Activate network control
- Bit 6 ≡ Activate network setpoint
- Function code 6, i. e. writing into a single register.

Example of an inverter with the node address 1:

Request frame by the master							
Slave address	Function code	Register address		AC Drive control word Data: 0b1100001 ≡ 0x0061		Checksum (CRC)	
0x01	0x06	0x08	0x34	0x00	0x61	0x0B	0x8C

If digital input DI1 ("Start enable") is set to HIGH level, the drive should start and the inverter should respond with the same frame as confirmation:

Response message from the inverter							
Slave address	Function code	Register address		AC Drive control word Data: 0b1100001 ≡ 0x0061		Checksum (CRC)	
0x01	0x06	0x08	0x34	0x00	0x61	0x0B	0x8C

Parameter	Name / value range / [default setting]	Info
0x2631:037 (P400.37)	Function list: Activate network control (Function list: Network control) • For further possible settings, see parameter 0x2631:001 (P400.01) . 500	Assignment of a trigger for the "Activate network control" function. Trigger = TRUE: Activate network control. Trigger = FALSE: No action / deactivate network control again.
	0 Not connected	No trigger assigned (trigger is constantly FALSE).
	114 Network control active (from version 02.00)	TRUE if the network control is requested via bit 5 of the AC drive control word 0x400B:001 (P592.01) . Otherwise FALSE. Notes: • Set this selection if the network control is to be activated via bit 5 of the AC drive control word. • The AC drive control word can be used with any communication protocol. ▶ AC Drive Profile 221

Configuring the network

Modbus TCP/IP
Modbus TCP/IP module



8.9.10 Modbus TCP/IP module

Parameter	Name / value range / [default setting]	Info
0x23B0 (P508.00)	Modbus TCP communication (MBTCP comm.) • From version 04.00	Restart / stop communication
	0 No action/no error	Only status feedback.
	1 Restart with current values	Restart communication in order that changed settings of the interface configuration become effective.
	2 Restart with default values	Restart communication with the standard values.
	5 Stop network communication	Stop communication.
	10 In progress	Only status feedback
	11 Action cancelled	
	12 Error	

8.9.11 Drive control configuration

Parameter	Name / value range / [default setting]	Info
0x23B4:001 (P512.01)	Port settings: Port 1 (Port settings: Port 1) • From version 04.00	Set baud rate for the port 1.
	0 Auto-Negotiation	
	1 10 Mbps	
	2 100 Mbps	
	5 10 Mbps/Half Duplex	
	6 10 Mbps/Full Duplex	
	7 100 Mbps/Half Duplex	
	8 100 Mbps/Full Duplex	
0x23B4:002 (P512.02)	Port settings: Port 2 (Port settings: Port 2) • From version 04.00	Set baud rate for the port 2.
	0 Auto-Negotiation	
	1 10 Mbps	
	2 100 Mbps	
	5 10 Mbps/Half Duplex	
	6 10 Mbps/Full Duplex	
	7 100 Mbps/Half Duplex	
	8 100 Mbps/Full Duplex	
0x23B5:001 (P513.01)	Active port settings: Port 1 (Act. port sett.: Port 1) • Read only • From version 04.00	Display of the baud rate set for the port 1 in parameter 0x23B4:001 (P512.01) .
	0 Not connected	
	1 10 Mbps/Half Duplex	
	2 10 Mbps/Full Duplex	
	3 100 Mbps/Half Duplex	
	4 100 Mbps/Full Duplex	
0x23B5:002 (P513.02)	Active port settings: Port 2 (Act. port sett.: Port 2) • Read only • From version 04.00	Display of the baud rate set for the port 2 in parameter 0x23B4:002 (P512.02) .
	0 Not connected	
	1 10 Mbps/Half Duplex	
	2 10 Mbps/Full Duplex	
	3 100 Mbps/Half Duplex	
	4 100 Mbps/Full Duplex	



8.10 PROFINET



PROFINET® (Process Field Network) is a real-time capable fieldbus system based on Ethernet.

- Detailed information on PROFINET can be found on the web page of the PROFIBUS & PROFINET International (PI) user organisation: <http://www.profibus.com>
- Information about the dimensioning of a PROFINET network can be found in the configuration document for the inverter.
- PROFINET® is a registered trademark and patented technology licensed by the PROFIBUS & PROFINET International (PI) user organisation.

Preconditions

- Control unit (CU) of the inverter is provided with PROFINET.
- The GSDML device description files for PROFINET can be found here: <http://www.lenze.com/application-knowledge-base/artikel/200804173/0/>

8.10.1 PROFINET introduction

The inverter is implemented as IO-Device into a PROFINET network. PROFINET transmits between the IO-Devices and the IO-Controller (in the following, this term is used instead of "PLC" or "host system") parameter data, configuration data, diagnostic data, alarm messages and process data.

The data is transmitted as a function of its time-critical behaviour via corresponding communication channels.

Supported services

Equipment	Inverter
Conformance	Class CCB
Option according to conformance class	Media Redundancy Protocol
Device class	IO device
According to PN specification	V2.2
Safety channel support	-
Shared device	-
Device access	TCI, I&M0 ... 4
Device profile support	-
Conductor access	OK
The second inverter	Yes
Fast startup	No. (typical starting times, approx. 11 seconds)
Topology support	LLDP MIB, station alias
PN blinking function	OK
Alarm type	User
Acyclic services	OK
Additional Ethernet channel	TCP/IP channel
Lenze GCI support	OK
Lenze ESDCP support	OK
Power over Ethernet PoE	-
External 24V current supply	X3 24E / GND
Optical fiber support	-

Configuring the network

PROFINET
PROFINET configuration



8.10.2 PROFINET configuration

For communicating with the inverter, the IO controller must be configured.

The configuration of the IO controller comprises

- the loading of the device description file into the IO controller,
- the assignment of a station name for the inverter and
- the assignment of an IP address for the inverter.

The station name and the IP address are assigned by the IO controller. The assignment can also be made by the Lenze engineering tool.

Preconditions

- The entire wiring of the inverter has already been checked for completeness, short circuit and earth fault.
- The GSDML device description file for PROFINET must be downloaded from <http://www.lenze.com/application-knowledge-base/artikel/200804173/0/> . Please observe the required system requirements and the notes regarding the inverter.

Device description file

The current device description file is installed in the engineering tool used for configuring the network. Thus, an unambiguous station name is assigned to the inverter which makes it possible for the IO controller to identify the device in the network and manage the data exchange with the other network nodes.

The designation of the device description file is as follows:

"GSDML-V<x>.<z>-Lenze-i<NNN>PN<Version>-<yyyy><mm><dd>.xml".

The information in the wildcards (angle brackets) are explained in the following:

Wildcard	Info
x	Major version of the used GSDML scheme
z	Minor version of the used GSDML scheme
NNN	Specifying the inverter designation, e.g. i<550>
Version	First software version that can be used with this GSDML. This data must not be changed.
yyyy	Year of publication
mm	Month of publication
dd	Day of publication

Tab. 1: Explanation of the wildcards in the designation of the device description file

Station name

The station name is required for the clear addressing of the inverter by the IO controller.

The station name of the inverter must be entered into the [0x2381:004 \(P510.04\)](#) parameter with permissible characters according to the PROFINET specification. The characters permissible for the name allocation are given in the specification.

The station name is read out with [0x2382:004 \(P511.04\)](#).

IP address

The IP address makes it possible to access the inverter in the entire network.

For configuring the IP address, the subnet mask and gateway address must also be assigned:

- [0x2381:001 \(P510.01\)](#): IP address
- [0x2381:002 \(P510.02\)](#): Subnet mask
- [0x2381:003 \(P510.03\)](#): Gateway address

All three settings are read out with the parameters [0x2382:001 \(P511.01\)](#) ... [0x2382:003 \(P511.03\)](#).



Configuring the network

PROFINET
PROFINET configuration

Parameter	Name / value range / [default setting]	Info
0x2380 (P508.00)	PROFINET communication (PROFINET comm.) • From version 02.00	Restart / stop communication • When the device command has been executed successfully, the value 0 is shown.
	0 No action/no error	Only status feedback
	1 Restart with current values	Restart communication with the current values.
	2 Restart with default values	Restart communication with the standard values of the PROFINET parameters (0x2381:001 ... 0x2381:009).
	5 Stop network communication	Stop communication
	10 In process	Only status feedback
	11 Action cancelled	
	12 Fault	
0x2381:001 (P510.01)	PROFINET settings: IP address (PROFINET sett.: IP address) 0 ... [0] ... 4294967295 • From version 02.00	Set IP address • The change of this parameter becomes only effective after a restart.
0x2381:002 (P510.02)	PROFINET settings: Subnet (PROFINET sett.: Subnet) 0 ... [0] ... 4294967295 • From version 02.00	Set subnet mask • The change of this parameter becomes only effective after a restart.
0x2381:003 (P510.03)	PROFINET settings: Gateway (PROFINET sett.: Gateway) 0 ... [0] ... 4294967295 • From version 02.00	Set gateway address • The gateway address is valid if the network address of the IP address is identical to the gateway address. In this case, no gateway functionality is used. • DHCP is not supported. • The change of this parameter becomes only effective after a restart.
0x2381:004 (P510.04)	PROFINET settings: Station name (PROFINET sett.: Station name) • From version 02.00	Set station name • The change of this parameter becomes only effective after a restart.
0x2381:005	PROFINET settings: I&M1 System designation • From version 02.00	Input/output of the I&M1 system designation • The default setting is an empty string.
0x2381:006	PROFINET settings: I&M1 Installation site • From version 02.00	Input/output of the I&M1 location identification code • The default setting is an empty string.
0x2381:007	PROFINET settings: I&M2 Installation date • From version 02.00	Input/output of the I&M1 date of installation • The default setting is an empty string.
0x2381:008	PROFINET settings: I&M3 additional information • From version 02.00	Input/output of the I&M1 additional information • The default setting is an empty string.
0x2381:009	PROFINET settings: I&M4 signature code • From version 02.00	Input/output of the I&M1 signature • The default setting is an empty string.

Configuring the network



PROFINET
PROFINET LED status displays





8.10.3 PROFINET LED status displays

Information on the network status can be obtained quickly via the "BUS RDY" and "BUS ERR" LED displays on the front of the inverter. In addition, the LEDs at the RJ45 sockets indicate the PROFINET connection status.

The meaning of the "BUS RDY" and "BUS ERR" LEDs can be obtained from the following two tables.

LED "BUS RDY" (green)	Status/meaning
off	No connection to the master
 Blinking	PLC in STOP
 on	PLC in RUN (DATA_EXCHANGE)

LED "BUS ERR" (red)	Status/meaning
off	No fault
 flickers	The PROFINET function "Node flashing test" is triggered by the IO controller. The flickering LED serves to identify (locate) accessible IO devices
 blinking	Impermissible settings: Stack, station name or IP parameters are invalid.
 on (red)	Communication error (e.g. Ethernet cable removed)

Status displays at the RJ45 sockets

The LEDs at the RJ45 sockets indicate the PROFINET connection status:

LED "Link" (green)	Status/meaning
off	No PROFINET connection.
 on	A physical PROFINET connection is available.

LED "Activity" (yellow)	Status/meaning
off	No PROFINET data transfer.
 on or flickers	Data is exchanged via PROFINET.

8.10.4 PROFINET diagnostics

The parameters for diagnosing the network are described below.

Parameter	Name / value range / [default setting]	Info
0x2382:001 (P511.01)	Active PROFINET settings: IP address (PROFINET diag.: IP address) • Read only • From version 02.00	Display of the active IP address.
0x2382:002 (P511.02)	Active PROFINET settings: Subnet (PROFINET diag.: Subnet) • Read only • From version 02.00	Display of the active subnet mask.
0x2382:003 (P511.03)	Active PROFINET settings: Gateway (PROFINET diag.: Gateway) • Read only • From version 02.00	Display of the gateway address.
0x2382:004 (P511.04)	Active PROFINET settings: Station name (PROFINET diag.: Station name) • Read only • From version 02.00	Display of the active station name.
0x2382:005 (P511.05)	Active PROFINET settings: MAC Address (PROFINET diag.: MAC Address) • Read only • From version 02.00	Display of the active MAC address.



Configuring the network

PROFINET
PROFINET diagnostics

Parameter	Name / value range / [default setting]	Info
0x2388 (P516.00)	PROFINET status (PROFINET status) • Read only • From version 02.00	Bit coded display of the current Bus status.
	Bit 0 Initialized	After initialisation, the network component waits for a communication partner and the system power-up.
	Bit 1 Online	
	Bit 2 Connected	
	Bit 3 IP address error	The IP address is invalid. Valid IP addresses are defined according to RFC 3330.
	Bit 4 Hardware fault	
	Bit 6 Watchdog elapsed	PROFINET communication is continuously interrupted in the "Data_Exchange" state, e.g. by cable break or failure of the IO Controller. • PROFINET communication changes to the "No_Data_Exchange" state. When the watchdog monitoring time specified by the IO Controller has elapsed, the response set in 0x2859:001 (P515.01) is triggered in the inverter.
	Bit 7 Protocol error	
	Bit 8 PROFINET stack ok	
	Bit 9 PROFINET stack not configured	
	Bit 10 Ethernet controller fault	
	Bit 11 UDP stack fault	
0x2389:001 (P517.01)	PROFINET error: Error 1 (PROFINET error: Error 1) • Read only • From version 02.00	• The error values may occur in combination with the error values from parameter 0x2389:002 (P517.02) .
	0 No error	
	1 Reserved	
	2 Unit ID unknown	
	3 Max. units exceeded	
	4 Invalid size	
	5 Unit type unknown	
	6 Runtime plug error	
	7 Invalid argument	
	8 Service pending	
	9 Stack not ready	
	10 Command unknown	
11 Invalid address descriptor		
0x2389:002 (P517.02)	PROFINET error: Error 2 (PROFINET error: Error2) • Read only • From version 02.00	The parameter currently contains the error detected on the network. • The error values may occur in combination with the error values from parameter 0x2389:001 (P517.01) .
	Bit 7 IP address error	The IP address is invalid. Valid IP addresses are defined according to RFC 3330.
	Bit 8 Station name problem	The station name must be assigned according to the PROFINET specification.
	Bit 9 DataExch left	
	Bit 10 Stack boot error	
	Bit 11 Stack online error	
	Bit 12 Stack state error	
	Bit 13 Stack revision error	
Bit 14 Initialization problem		
Bit 15 Stack init error	The stack cannot be initiated with the user specifications. A reason might be, e. g., a station name that does not correspond to the PROFINET specification.	

Configuring the network

PROFINET
PROFINET monitoring



8.10.5 PROFINET monitoring

The parameters for setting network monitoring functions are described below.

Parameter	Name / value range / [default setting]	Info
0x2859:001 (P515.01)	PROFINET monitoring: Watchdog elapsed (PROFINET monit.: WD elapsed) <ul style="list-style-type: none"> From version 02.00 For further possible settings, see parameter 0x2D45:001 (P310.01). 196 	Selection of the response to a permanent interruption of the communication to the IO controller. Associated error code: <ul style="list-style-type: none"> 33168 0x8190 - Network: watchdog timeout
	2 Trouble	Error types 113
0x2859:003 (P515.03)	PROFINET monitoring: Invalid configuration (PROFINET monit.: Invalid config) <ul style="list-style-type: none"> From version 02.00 For further possible settings, see parameter 0x2D45:001 (P310.01). 196 	Selection of the response triggered by the reception of invalid configuration data. Associated error code: <ul style="list-style-type: none"> 33414 0x8286 - Network: PDO mapping error
	2 Trouble	Error types 113
0x2859:004 (P515.04)	PROFINET monitoring: Initialisation error (PROFINET monit.: Init. error) <ul style="list-style-type: none"> From version 02.00 For further possible settings, see parameter 0x2D45:001 (P310.01). 196 	Selection of the response triggered by the occurrence of an error during the initialisation of the network component. Associated error code: <ul style="list-style-type: none"> 33170 0x8192 - Network: initialisation error
	2 Trouble	Error types 113
0x2859:005 (P515.05)	PROFINET monitoring: Invalid process data (PROFINET monit.: Inval. proc.data) <ul style="list-style-type: none"> From version 02.00 For further possible settings, see parameter 0x2D45:001 (P310.01). 196 	Selection of the response triggered by the reception of invalid process data. Process data marked as invalid (IOPS is "BAD") are received by the IO Controller. Typically in case of <ul style="list-style-type: none"> a PLC in STOP state, alarms, acyclic demand data. Associated error code: <ul style="list-style-type: none"> 33171 0x8193 - Network: invalid cyclic process data
	2 Trouble	Error types 113



8.10.6 PROFINET data mapping

The process data are used to control the inverter.

The process data is transmitted cyclically between the IO-Controller and the IO-Devices participating at the PROFINET:

- The available 27 network registers ("slots") serve to maximally exchange 16 process data words (data types 8-bit or 16-bit) or 8 process data double words (data type 32-bit) for each direction.
- Output data direction: From IO-Controller to IO-Device.
- Input data direction: From IO-Device to IO-Controller.

Data mapping is used to define which process data are exchanged cyclically between IO-Controller and IO-Device.

Details

- If the inverter is known in the PROFINET network as node and the IO-Controller connects to the IO-Device for the first time, the mapping objects are automatically transferred to the IO device, i. e. to the inverter.
- Internal mapping of the process output data is set in [0x24E0:001 ... 0x24E0:016](#).
- Internal mapping of the process input data is set in [0x24E1:001 ... 0x24E1:016](#).



All subsequent changes in the objects 0x24E1 and 0x24E1 can cause PROFINET alarms according to the deviation of the automatically set configurations.

Configuring the network

PROFINET
PROFINET data mapping



RPDO mapping



The assignment of different bits with the same function is not permissible.

For the process data from the master to the inverter, the following data mapping is preset in the device description file:

1. NetWordIN1 data word [0x4008:001 \(P590.01\)](#)
2. Network setpoint frequency (0.01) [0x400B:005 \(P592.05\)](#)
3. 16 bit selectable output data, mapped to Keypad setpoints: Process controller setpoint [0x2601:002 \(P202.02\)](#)

Function assignment of the NetWordIN1 data word

Bit	Default setting	For details and configuration, see
0	Not active (reserve)	0x400E:001 (P505.01)
1	Not active (reserve)	0x400E:002 (P505.02)
2	Activate quick stop	0x400E:003 (P505.03)
3	Not active (reserve)	0x400E:004 (P505.04)
4	Run forward (CW)	0x400E:005 (P505.05)
5	Activate preset (bit 0)	0x400E:006 (P505.06)
6	Activate preset (bit 1)	0x400E:007 (P505.07)
7	Reset error	0x400E:008 (P505.08)
8	Not active (reserve)	0x400E:009 (P505.09)
9	Activate DC braking	0x400E:010 (P505.10)
10	Not active (reserve)	0x400E:011 (P505.11)
11	Not active (reserve)	0x400E:012 (P505.12)
12	Invert rotation	0x400E:013 (P505.13)
13	Not active (reserve)	0x400E:014 (P505.14)
14	Not active (reserve)	0x400E:015 (P505.15)
15	Not active (reserve)	0x400E:016 (P505.16)

Specifying the frequency setpoint

- The specification is made unsigned (independent of the direction of rotation) as integer in the resolution [0.01 Hz].
- The direction of rotation is defined in the default setting via bit 12 of the NetWordIN1 data word.
- Example: 4560 \equiv 45.60 Hz



TPDO mapping



The assignment of different bits with the same function is not permissible.

For the process data from the inverter to the master, the following data mapping is preset in the device description file:

1. NetWordOUT1 data word [0x400A:001 \(P591.01\)](#)
2. Frequency (0.01) [0x400C:006 \(P593.06\)](#)
3. Motor current [0x2D88 \(P104.00\)](#)

Status assignment of the NetWordOUT1 data word

Bit	Default setting	For details and configuration, see
0	Ready for operation	0x2634:010 (P420.10)
1	Not connected	0x2634:011 (P420.11)
2	Operation enabled	0x2634:012 (P420.12)
3	Error active	0x2634:013 (P420.13)
4	Not connected	0x2634:014 (P420.14)
5	Quick stop active	0x2634:015 (P420.15)
6	Running	0x2634:016 (P420.16)
7	Device warning active	0x2634:017 (P420.17)
8	Not connected	0x2634:018 (P420.18)
9	Not connected	0x2634:019 (P420.19)
10	Setpoint speed reached	0x2634:020 (P420.20)
11	Current limit reached	0x2634:021 (P420.21)
12	Actual speed = 0	0x2634:022 (P420.22)
13	Rotational direction reversed	0x2634:023 (P420.23)
14	Release holding brake	0x2634:024 (P420.24)
15	Safe torque off (STO) active	0x2634:025 (P420.25)

Output of the actual frequency value

- The output is made unsigned (independent of the direction of rotation) as integer in the resolution [0.01 Hz].
- An active reversal is displayed via bit 13 of the NetWordOUT1 data word.
- Example: 4560 \equiv 45.60 Hz

Configuring the network

PROFINET

PROFINET data mapping



Example for changing a pre-assigned mapping

The assignment of the third output word is to be changed. Due to the device description file, this output word (designation "16 bit selectable OUT-data_1") has already been assigned with the keypad setpoint.

The keypad setpoint ([0x2601:002 \(P202.02\)](#)) is to be replaced by the acceleration ramp ([0x2917 \(P220.00\)](#)).

Proceeding

1. Mark the 3rd output word in the "Device view".
2. Select the "Module parameter" dialog in "Properties".
 - a) Display in "Index": 9729 (decimal form of the index 0x2601)
 - b) Display in "Subindex": 2
3. Replace keypad setpoint [0x2601:002 \(P202.02\)](#) by acceleration ramp [0x2917 \(P220.00\)](#)
 - a) Use the [Parameter attribute list](#) to check whether mapping is permitted for the current parameter to be mapped and the data type is complied with. [618](#)
 - b) Entry in "Index": 10519 (decimal form of the index 0x2917)
 - c) Entry in "Subindex": 0



The acceleration time must be defined later, e.g. at the FB LCB_ActuatorSpeed, input wFreeCtrl, with the factor 10 (10 s \equiv 100).



8.10.7 PROFINET - acyclic data transfer

Data communication with PROFINET is characterised by the simultaneous operation of cyclic and acyclic services in the network. As an optional extension, the parameter data transfer belongs to the acyclic services.

Details

- Only one parameter request is processed at a time (no pipelining).
- No spontaneous messages are transferred.
- There are only acyclic parameter requests.
- Profile-specific parameters can be independently of the states of the IO-Device.

An IO-Controller can always request parameters from the IO-Device if the IO-Device is in the DATA_EXCHANGE state.

Transmission directions for acyclic data transfer

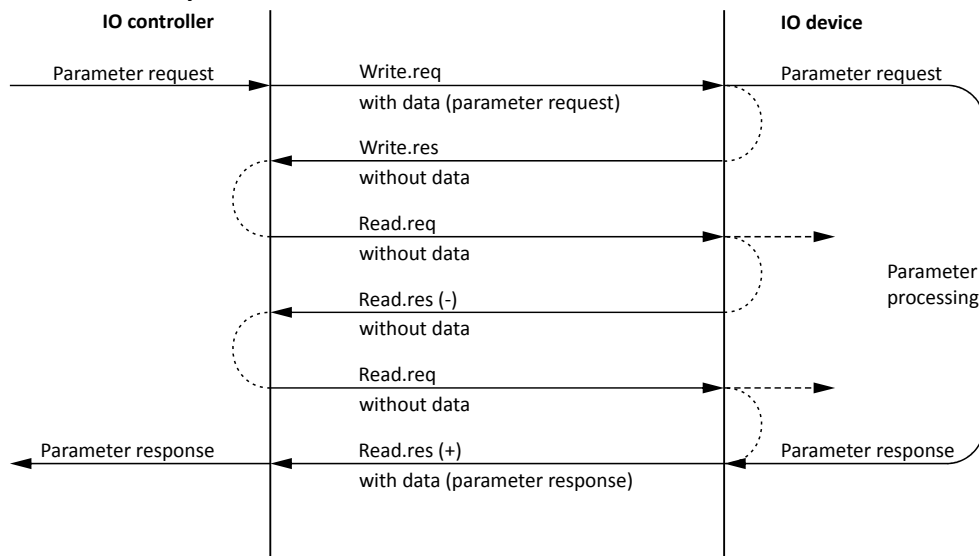

1. A "Write.req" is used to transmit the data set (DB47) to the IO-Device in the form of a parameter request.
2. With "Write.res", the IO-Controller receives the confirmation for the receipt of the message.
3. The IO-Controller requests the response of the IO-Device with "Read-req".
4. The IO-Device responds with a "Read.res (-)" if processing has not been completed yet.
5. After parameter processing, the parameter request is completed by transmitting the parameter response to the IO-Controller with "Read.res (+)".

Telegram structure

Destr	ScrAddr	VLAN	Type 0x0800	RPC	NDR	Read/Write Block	Data	FCS
6 bytes	6 bytes	4 bytes	4 bytes	80 bytes	64 bytes	64 bytes	0 240 bytes	4 bytes

In the **Read / Write Block** field, the initiator specifies the access to the "DB47" data set. The data that is written on this index or read by it, contain a header and the parameter request or the parameter response. The read data or the data to be written are contained in the **Data** field.

Configuring the network

PROFINET

PROFINET - acyclic data transfer



Assignment of the user data depending on the data type

Depending on the data type used, the user data are assigned as follows:

Data type	Length	User data assignment				
		Byte 1	Byte 2	Byte 3	Byte 4	Byte ...
String	x bytes	<i>Data</i> (x bytes)				
U8	1 byte	<i>Data</i>	0x00			
U16	2 bytes	HIGH byte <i>Data</i>	LOW byte <i>Data</i>			
U32	4 bytes	HIGH word		LOW word		
		HIGH byte <i>Data</i>	LOW byte <i>Data</i>	HIGH byte <i>Data</i>	LOW byte <i>Data</i>	



8.10.8 Basic drive control via PROFINET

In the following, the steps required for controlling the inverter via PROFINET are described.

Parameterisation required



On the control side, all commissioning steps are carried out with the engineering tool of an original equipment manufacturer (e.g. »Siemens TIA Portal«). Please note that in the standard setting of the used engineering tool, changes of network parameters carried out by a Lenze engineering tool (e.g. »EASY Starter«) may be overwritten.

1. Go to the device configuration and open the "net view" to drag the inverter from the catalog to the net view of the PROFINET.

Condition: The device description file has been installed before, see [PROFINET configuration](#).

2. Assign the inverter to the associated IO controller.
3. Mark the inverter and change to the "device view".
4. Set the IP address and the station name ("PROFINET device name") in "Properties".

For setting of the IP address and the station name, see [PROFINET configuration](#).



In order that the inverter can be identified via Ethernet when the IO controller is switched off, it is necessary that the IP address is saved in the inverter with mains failure protection via the separate entry with the »EASY Starter«.

Please observe the notes in the section [Save parameter settings in the memory module](#) and use the `0x2022:003 (P700.03)` parameter for saving the settings.

5. Activate network control: `0x2631:037 (P400.37) = "TRUE [1]"`
6. Set network as standard setpoint source: `0x2860:001 (P201.01) = "Network [5]"`
7. Below the module name and the name of the device description file, the device view shows the pre-assignment of three output and input process data objects (TPDO / RPDO) each:

Module
▼ LENZE-I550-DRIVE_2
▶ IOFW51ARXX
L-Controlword 0x4008:01_1
Netwfreq. 0.01Hz 0x400B:05_1
16Bit selectable OUT-Data_1
L-Statusword 0x400A:01_1
Act.freq. 0.01Hz 0x400C:06_1
Act.mot.current 0x2D88:00_1

- In the device view, further process data words can be added or preassigned PDOs can be changed. Please make sure that all addresses of the input and output data words follow each other without any gaps.
 - Please observe the description for data mapping, see [PROFINET data mapping](#) and the subsequent "example for changing a pre-assigned mapping".
8. Save configuration in the engineering tool.
 9. Load project into the IO controller.
 10. Get the IO controller to "RUN", e.g. by setting bit 4 in the control word NetWordIN1 `0x400E:005 (P505.05)`.
 - The startup causes the current configuration to be transferred to the inverter.
 - If required, save mapping and all other parameters in the inverter with mains failure protection, see [Save parameter settings in the memory module](#).

Configuring the network

PROFINET

Basic drive control via PROFINET

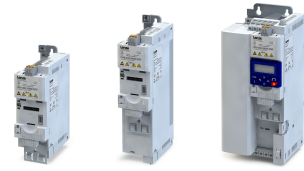

Restart or stop communication

The following parameter can be used to restart or stop communication. Optionally it is also possible to reset all communication parameters to the default status.

A restart of communication is required after changes of the interface configuration (e. g. station address and baud rate) in order that the changed settings become effective.

For restarting communication, there are two options:

1. Switch inverter off and on again.
2. Set the selection = "Restart with current values [1]" in [0x2380 \(P508.00\)](#).



8.11 EtherCAT



EtherCAT® (Ethernet for Controller and Automation Technology) is an Ethernet-based fieldbus system which fulfils the application profile for industrial realtime systems.

- EtherCAT® is a registered trademark and patented technology, licensed by Beckhoff Automation GmbH, Germany.
- Detailed information on EtherCAT can be found on the web page of EtherCAT Technology Group (ETG): <http://www.ethercat.org>
- Information about the dimensioning of an EtherCAT network can be found in the configuration document for the inverter.

Preconditions

- The control unit (CU) of the inverter is provided with EtherCAT (from firmware 02.00).
- For commissioning, the »PLC Designer« and current device description files for EtherCAT are available:
 - Download »PLC Designer«
 - Download XML/ESI files for Lenze devices

Properties and supported services

Properties / supported services	
CoE (CANopen over EtherCAT)	✓
FSoE (Fail Safety over EtherCAT)	-
Operating modes	<ul style="list-style-type: none"> • Free run • Config • Run
Access	<ul style="list-style-type: none"> • Logical write (W) • Logical read/write (RW)
Maximum process data length per direction (Rx/Tx)	32 bytes
FMMU (Fieldbus Memory Management Units)	3*
SM (Sync-Managers)	4
DC synchronisation	-
Topology addressing	✓
Second slave address	Only via EEPROM
Explicit Device Identification Mode	✓
✓ Is supported. - Is not supported. * Available for data mapping.	

Restart of the network communication

The network communication is restarted with **0x2360 (P508.00) = 1**.

Parameter	Name / value range / [default setting]	Info
0x2360 (P508.00)	EtherCAT communication (EtherCAT comm.)	Restart communication.
	• From version 02.00	• When the device command has been executed successfully, the value 0 is shown.
	0 No action/no error	Only status feedback
	1 Restart with current values	Restart communication with the current values.
	10 In process	Only status feedback
	11 Action cancelled	
12 Fault		

Configuring the network

EtherCAT
Device identification



8.11.1 Device identification

The EtherCAT objects for identifying the devices are described below.

The objects can only be accessed via the EtherCAT network.

Parameter	Name / value range / [default setting]	Info
0x1000	Device type • Read only • From version 02.00	CANopen device profile according CANopen specification CiA 301/ CiA 402.
0x1008	Manufacturer device name • Read only • From version 02.00	Display of the manufacturer device name.
0x1009	Manufacturer hardware version • Read only • From version 02.00	Display of the manufacturer hardware version.
0x100A	Manufacturer software version • Read only • From version 02.00	Display of the manufacturer software version.
0x1018:001	Identity object: Vendor ID • Read only • From version 02.00	Display of the manufacturer's identification number.
0x1018:002	Identity object: Product code • Read only • From version 02.00	Display of the product code of the inverter.
0x1018:003	Identity object: Revision number • Read only • From version 02.00	Display of the main and subversion of the firmware.
0x1018:004	Identity object: Serial number • Read only • From version 02.00	Display of the serial number of the inverter.



8.11.2 EtherCAT configuration

Addressing the EtherCAT devices

The EtherCAT devices are normally addressed via a permanent 16-bit address defined by the master. At the start, this address is assigned automatically to each node by the master, depending on the physical order in the network. The address is not saved and gets lost when the device is switched off.

"Explicit Device Identification" via rotary encoder switch or parameter

The "Explicit Device Identification" is required if the device is part of a "Hot Connect" group or the device is operated within a modular Lenze machine application. Each slave receives an *unambiguous* identifier for being identified by the master.

Setting	Assignment of the identifier
0x00	Identifier via the parameter 0x2361:004 (P510.04) .
0x01 ... 0xFF	Identifier via the rotary encoder switches. Example: Setting for the value 52 $(3 \times 16) + (4 \times 1) = 52$ <div style="text-align: center; margin-top: 10px;"> </div>

The value set via the rotary encoder switches is used once when the mains is switched on or after a network restart with [0x2360 \(P508.00\) = 1](#). A changed value during operation will only become valid after the network has been restarted.

As an alternative, a master can also use station alias addresses of the slaves that are configured and *unambiguous* in the network. For this purpose, a station alias address must be saved in the EEPROM of the device by setting the corresponding register.

The parameters for addressing the device are described below.

Parameter	Name / value range / [default setting]	Info
0x2361:004 (P510.04)	EtherCAT settings: Device identifier (EtherCAT sett.: Device ident.) 0 ... [0] ... 65535 • From version 02.00	Setting of the identifier <i>unambiguous</i> in the network (Explicit Device Identification). This setting is only valid for rotary encoder switch setting 0 (0x00).
0x2363 (P509.00)	EtherCAT switch position (EtherC. switch) • Read only • From version 02.00	Display of the current rotary encoder switch settings.

Configuring the network





EtherCAT
EtherCAT LED status displays



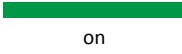

8.11.3 EtherCAT LED status displays

Information on the network status can be obtained quickly via the "BUS RDY" and "BUS ERR" LED displays on the front of the inverter. In addition, the LEDs at the RJ45 sockets indicate the EtherCAT connection status.

The meaning of the "BUS RDY" and "BUS ERR" LEDs can be obtained from the following two tables.

LED "BUS RDY" (green)	EtherCAT status	Status/meaning
off	off / Init	The network option is not active at the network or is in the "Init" status.
 blinking	Pre-Operational	Access to parameters and objects possible. No process data exchange.
 on	Safe-Operational	The data is not active yet in the standard device.
 on	Operational	The network option works correctly.
 flickers	Bootstrap	Firmware update of the network option active.

LED "BUS ERR" (red)	Status/meaning
off	No fault
 flickers	Local error. The network option changes automatically to the "Safe-Operational" status.
 on (red)	A "Sync Manager Watchdog Timeout" has occurred.
 blinking	The configuration is invalid/incorrect.

Status display at the RJ45 sockets

The LED "L/A" at the RJ45 sockets shows the EtherCAT connection status:

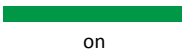
LED "L/A" (green)	Status/meaning
off	No EtherCAT connection.
 flickers	Data is exchanged via EtherCAT.
 on	A physical EtherCAT connection is available.

8.11.4 EtherCAT diagnostics

The parameters for diagnosing the network are described below.

Parameter	Name / value range / [default setting]	Info
0x2362:004 (P511.04)	Active EtherCAT settings: Device identifier (EtherCAT diag.: Device ident.) • Read only • From version 02.00	Display of the clear device address in the network which is defined via rotary encoder switch or object 0x2361:004 (P510.04).
0x2362:006 (P511.06)	Active EtherCAT settings: Station address (EtherCAT diag.: Station address) • Read only • From version 02.00	Display of the active station address.
0x2362:007 (P511.07)	Active EtherCAT settings: Tx length (EtherCAT diag.: Tx length) • Read only • From version 02.00	Display of the length of the transmitted cyclic data in bytes.
0x2362:008 (P511.08)	Active EtherCAT settings: Rx length (EtherCAT diag.: Rx length) • Read only • From version 02.00	Display of the length of the received cyclic data in bytes.



Parameter	Name / value range / [default setting]	Info
0x2368 (P516.00)	EtherCAT status (EtherCAT status)	Display of the current network status.
	<ul style="list-style-type: none"> • Read only • From version 02.00 	
	1 Initialisation	Network initialisation is active. <ul style="list-style-type: none"> • No PDO/SDO transmission. • Device identification is possible by network scan.
	2 Pre-Operational	The network is active. <ul style="list-style-type: none"> • SDO transmission (CoE communication via mailbox) is possible. • No PDO transmission.
	3 Bootstrap	Firmware update active. <ul style="list-style-type: none"> • For the firmware update, the FoE protocol is used. • No PDO transmission.
	4 Safe-Operational	SDO transmission (CoE communication via mailbox) is possible. PDO transmission: <ul style="list-style-type: none"> • The input data in the process image are updated. • The output data from the process image are not transmitted.
0x2369 (P517.00)	8 Operational	Normal operation <ul style="list-style-type: none"> • PDO/SDO transmission is possible. • Network synchronisation is successful (if used).
	EtherCAT error (EtherCAT error)	Bit coded display of EtherCAT errors.
	<ul style="list-style-type: none"> • Read only • From version 02.00 	

8.11.5 EtherCAT monitoring

The parameters for setting network monitoring functions are described below.

Parameter	Name / value range / [default setting]	Info
0x2859:001 (P515.01)	EtherCAT monitoring: Watchdog elapsed (EtherCAT monit.: WD elapsed)	Selection of the response to the continuous interruption of communication to the EtherCAT master, e. g. by cable break or failure of the EtherCAT master.
	<ul style="list-style-type: none"> • From version 02.00 • For further possible settings, see parameter 0x2D45:001 (P310.01). □ 196 	Associated error code: <ul style="list-style-type: none"> • 33168 0x8190 - Network: watchdog timeout
	2 Trouble	▶ Error types □ 113
0x2859:003 (P515.03)	EtherCAT monitoring: Invalid configuration (EtherCAT monit.: Invalid config)	Selection of the response triggered by the reception of invalid configuration data.
	<ul style="list-style-type: none"> • From version 02.00 • For further possible settings, see parameter 0x2D45:001 (P310.01). □ 196 	Associated error code: <ul style="list-style-type: none"> • 33414 0x8286 - Network: PDO mapping error
	2 Trouble	▶ Error types □ 113
0x2859:004 (P515.04)	EtherCAT monitoring: Initialisation error (EtherCAT monit.: Init. error)	Selection of the response triggered by the occurrence of an error during the initialisation of the network component.
	<ul style="list-style-type: none"> • From version 02.00 • For further possible settings, see parameter 0x2D45:001 (P310.01). □ 196 	Associated error code: <ul style="list-style-type: none"> • 33170 0x8192 - Network: initialisation error
	2 Trouble	▶ Error types □ 113
0x2859:005 (P515.05)	EtherCAT monitoring: Invalid process data (EtherCAT monit.: Inval. proc.data)	Selection of the response triggered by the reception of invalid process data.
	<ul style="list-style-type: none"> • From version 02.00 • For further possible settings, see parameter 0x2D45:001 (P310.01). □ 196 	Associated error code: <ul style="list-style-type: none"> • 33171 0x8193 - Network: invalid cyclic process data
	2 Trouble	▶ Error types □ 113

Configuring the network

EtherCAT
EtherCAT objects



8.11.6 EtherCAT objects

The parameters for the implemented EtherCAT objects are described below.

Parameter	Name / value range / [default setting]	Info
0x2360 (P508.00)	EtherCAT communication (EtherCAT comm.)	Restart communication. • When the device command has been executed successfully, the value 0 is shown.
	0 No action/no error	Only status feedback
	1 Restart with current values	Restart communication with the current values.
	10 In process	Only status feedback
	11 Action cancelled	
	12 Fault	
0x2361:004 (P510.04)	EtherCAT settings: Device identifier (EtherCAT sett.: Device ident.) 0 ... [0] ... 65535 • From version 02.00	Setting of the identifier <i>unambiguous</i> in the network (Explicit Device Identification). This setting is only valid for rotary encoder switch setting 0 (0x00).
0x2362:004 (P511.04)	Active EtherCAT settings: Device identifier (EtherCAT diag.: Device ident.) • Read only • From version 02.00	Display of the clear device address in the network which is defined via rotary encoder switch or object 0x2361:004 (P510.04) .
0x2362:006 (P511.06)	Active EtherCAT settings: Station address (EtherCAT diag.: Station address) • Read only • From version 02.00	Display of the active station address.
0x2362:007 (P511.07)	Active EtherCAT settings: Tx length (EtherCAT diag.: Tx length) • Read only • From version 02.00	Display of the length of the transmitted cyclic data in bytes.
0x2362:008 (P511.08)	Active EtherCAT settings: Rx length (EtherCAT diag.: Rx length) • Read only • From version 02.00	Display of the length of the received cyclic data in bytes.
0x2363 (P509.00)	EtherCAT switch position (EtherC. switch) • Read only • From version 02.00	Display of the current rotary encoder switch settings.
0x2368 (P516.00)	EtherCAT status (EtherCAT status) • Read only • From version 02.00	Display of the current network status.
	1 Initialisation	Network initialisation is active. • No PDO/SDO transmission. • Device identification is possible by network scan.
	2 Pre-Operational	The network is active. • SDO transmission (CoE communication via mailbox) is possible. • No PDO transmission.
	3 Bootstrap	Firmware update active. • For the firmware update, the FoE protocol is used. • No PDO transmission.
	4 Safe-Operational	SDO transmission (CoE communication via mailbox) is possible. PDO transmission: • The input data in the process image are updated. • The output data from the process image are not transmitted.
	8 Operational	Normal operation • PDO/SDO transmission is possible. • Network synchronisation is successful (if used).
0x2369 (P517.00)	EtherCAT error (EtherCAT error) • Read only • From version 02.00	Bit coded display of EtherCAT errors.

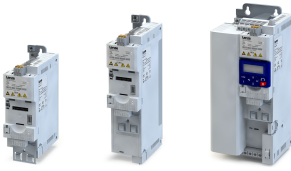

8.1.1.7 EtherCAT - cyclic data transfer

- Process data are cyclically transferred between the EtherCAT master and the slaves (permanent exchange of current input and output data).
- The transfer of process data is time-critical.
- The process data serve to control the EtherCAT slaves.
- The process data can be directly accessed by the master. The data in the PLC, for instance, are directly stored in the I/O area.
- The contents of the process data are defined via I/O Data mapping (definition of the EtherCAT objects that are to be transmitted cyclically).
- Process data are not saved in the device.
- Process data are, e. g. setpoints, actual values, control and status words.

Configuration

- The available objects can be mapped in the CiA 402 operating mode "CiA: Velocity mode" (0x6060 (P301.00) = 2) and as dynamic (free) configuration. The contents can be selected from all mappable objects.
 - Mapping objects for the CiA 402 operating mode "CiA: Velocity mode": 0x1603:001 and 0x1603:002 (RPDOs), 0x1A03:001 ... 0x1A03:003 (TPDOs)
 - Mapping objects for a dynamic (free) assignment: 0x1605:001 ... 0x1605:016 (RPDOs), 0x1A05:001 ... 0x1A05:016 (TPDOs)
- The freely configurable mapping objects contain an 8 bit dummy entry (0x00050008). This ensures that each object is transferred cyclically with 16 bits.
- Mapping is executed in the master configuration and automatically transferred to the slave.
- The data format is 0xAAAABBCC (AAAA = index, BB = subindex, CC = length).

Standard mapping of the RPDOs in the CiA 402 operating mode "CiA: Velocity mode"

Master → slave	
0x1603:001 RPDO mapping entry 1 (CiA: Velocity mode)	CiA: Controlword (0x6040)
0x1603:002 RPDO mapping entry 2 (CiA: Velocity mode)	CiA 402 parameter "Target velocity" (0x6042 (P781.00))
0x1605:001 RPDO mapping Entry 1 (freely configurable)	Not assigned.

Standard mapping of the TPDOs in the CiA 402 operating mode "CiA: Velocity mode"

Slave → master	
0x1A03:001 TPDO mapping entry 1 (CiA: Velocity mode)	CiA: Statusword (0x6041 (P780.00))
0x1A03:002 TPDO mapping entry 2 (CiA: Velocity mode)	CiA 402 parameter "Velocity actual value" (0x6044 (P783.00))
0x1A03:003 TPDO mapping entry 3 (CiA: Velocity mode)	Error code (0x603F (P150.00))
0x1A05:001 TPDO mapping entry 1 (freely configurable)	Digital inputs

Expert settings

- The sync managers are configured for the cyclic data transfer and the mailbox communication (display in 0x1C00:001 ... 0x1C00:004).
- For the communication, the I/O data mapping must be configured via 0x1C12:000 ... 0x1C12:002 (for RPDOs) and 0x1C13:000 ... 0x1C13:002 (for TPDOs).
- The basic settings for the sync managers are made via 0x1C32:001 ... 0x1C32:005 and 0x1C33:001 ... 0x1C33:005.

In the following, the EtherCAT objects are described (Mapping-Objekt-Index), that can be assigned to process data.

The objects can only be accessed via the EtherCAT network.

Parameter	Name / value range / [default setting]	Info
0x1603:001	RPDO4 mapping parameter: Application object 1 <ul style="list-style-type: none"> • Read only • From version 02.00 	Predefined mapping entry of CiA: Controlword (0x6040) for the CiA 402 operating mode "CiA: Velocity mode" (0x60400010).
0x1603:002	RPDO4 mapping parameter: Application object 2 <ul style="list-style-type: none"> • Read only • From version 02.00 	Predefined mapping entry of "CiA: Target velocity" für den "Velocity Mode" (0x60420010).

Configuring the network

EtherCAT

EtherCAT - cyclic data transfer



Parameter	Name / value range / [default setting]	Info
0x1605:001	RPDO6 mapping parameter: Application object 1 • Read only • From version 02.00	Mapping entry for the selection of an object to be received.
0x1605:002	RPDO6 mapping parameter: Application object 2 • Read only • From version 02.00	
0x1605:003	RPDO6 mapping parameter: Application object 3 • Read only • From version 02.00	
0x1605:004	RPDO6 mapping parameter: Application object 4 • Read only • From version 02.00	
0x1605:005	RPDO6 mapping parameter: Application object 5 • Read only • From version 02.00	
0x1605:006	RPDO6 mapping parameter: Application object 6 • Read only • From version 02.00	
0x1605:007	RPDO6 mapping parameter: Application object 7 • Read only • From version 02.00	
0x1605:008	RPDO6 mapping parameter: Application object 8 • Read only • From version 02.00	
0x1605:009	RPDO6 mapping parameter: Application object 9 • Read only • From version 02.00	
0x1605:010	RPDO6 mapping parameter: Application object 10 • Read only • From version 02.00	
0x1605:011	RPDO6 mapping parameter: Application object 11 • Read only • From version 02.00	
0x1605:012	RPDO6 mapping parameter: Application object 12 • Read only • From version 02.00	
0x1605:013	RPDO6 mapping parameter: Application object 13 • Read only • From version 02.00	
0x1605:014	RPDO6 mapping parameter: Application object 14 • Read only • From version 02.00	
0x1605:015	RPDO6 mapping parameter: Application object 15 • Read only • From version 02.00	
0x1605:016	RPDO6 mapping parameter: Application object 16 • Read only • From version 02.00	
0x1A03:001	TPDO4 mapping parameter: Application object 1 • Read only • From version 02.00	Predefined mapping entry of CiA: Statusword (0x6041 (P780.00)) for the CiA 402 operating mode "CiA: Velocity mode" (0x60410010).
0x1A03:002	TPDO4 mapping parameter: Application object 2 • Read only • From version 02.00	Predefined mapping entry of "CiA: Velocity actual value" für den "Velocity Mode" (0x60440010).
0x1A03:003	TPDO4 mapping parameter: Application object 3 • Read only • From version 02.00	Predefined mapping entry of "CiA: Error code" für den "Velocity Mode" (0x603F0010).



Configuring the network

EtherCAT

EtherCAT - cyclic data transfer

Parameter	Name / value range / [default setting]	Info
0x1A05:001	TPDO6 mapping parameter: Application object 1 • Read only • From version 02.00	Mapping entry for the selection of an object to be sent.
0x1A05:002	TPDO6 mapping parameter: Application object 2 • Read only • From version 02.00	
0x1A05:003	TPDO6 mapping parameter: Application object 3 • Read only • From version 02.00	
0x1A05:004	TPDO6 mapping parameter: Application object 4 • Read only • From version 02.00	
0x1A05:005	TPDO6 mapping parameter: Application object 5 • Read only • From version 02.00	
0x1A05:006	TPDO6 mapping parameter: Application object 6 • Read only • From version 02.00	
0x1A05:007	TPDO6 mapping parameter: Application object 7 • Read only • From version 02.00	
0x1A05:008	TPDO6 mapping parameter: Application object 8 • Read only • From version 02.00	
0x1A05:009	TPDO6 mapping parameter: Application object 9 • Read only • From version 02.00	
0x1A05:010	TPDO6 mapping parameter: Application object 10 • Read only • From version 02.00	
0x1A05:011	TPDO6 mapping parameter: Application object 11 • Read only • From version 02.00	
0x1A05:012	TPDO6 mapping parameter: Application object 12 • Read only • From version 02.00	
0x1A05:013	TPDO6 mapping parameter: Application object 13 • Read only • From version 02.00	
0x1A05:014	TPDO6 mapping parameter: Application object 14 • Read only • From version 02.00	
0x1A05:015	TPDO6 mapping parameter: Application object 15 • Read only • From version 02.00	
0x1A05:016	TPDO6 mapping parameter: Application object 16 • Read only • From version 02.00	
0x1C00:001	Sync Manager communication type: SM1 communication type • Read only • From version 02.00	The communication type SM1 is used for the mailbox input (MbxIn).
	0 Reserved	
	1 Receive mailbox	
	2 Transmit mailbox	
	3 Transmit process data	
	4 Receive process data	
0x1C00:002	Sync Manager communication type: SM2 communication type • Read only • From version 02.00	The communication type SM2 is used for the mailbox output (MbxOut).

Configuring the network

EtherCAT

EtherCAT - cyclic data transfer



Parameter	Name / value range / [default setting]	Info
0x1C00:003	Sync Manager communication type: SM3 communication type <ul style="list-style-type: none"> • Read only • From version 02.00 	The communication type SM3 is used for the input process data (RPDOs).
0x1C00:004	Sync Manager communication type: SM4 communication type <ul style="list-style-type: none"> • Read only • From version 02.00 	The communication type SM4 is used for the output process data (TPDOs).
0x1C12:000	Number of assigned PDOs <ul style="list-style-type: none"> • Read only • From version 02.00 	Number of selected RPDOs. These values are written by the master according to the selected settings in the master.
0x1C12:001	PDO mapping object index of assigned RxPDO 1 <ul style="list-style-type: none"> • Read only • From version 02.00 	Indication of the 1st mapping object index.
0x1C12:002	PDO mapping object index of assigned RxPDO 2 <ul style="list-style-type: none"> • Read only • From version 02.00 	Indication of the 2nd mapping object index.
0x1C13:000	Number of assigned PDOs <ul style="list-style-type: none"> • Read only • From version 02.00 	Number of selected TPDOs. These values are written by the master according to the selected settings in the master.
0x1C13:001	PDO mapping object index of assigned RxPDO 1 <ul style="list-style-type: none"> • Read only • From version 02.00 	Display of the 1st mapping object index.
0x1C13:002	PDO mapping object index of assigned RxPDO 2 <ul style="list-style-type: none"> • Read only • From version 02.00 	Display of the 2nd mapping object index.
0x1C32:001	Sync Manager 2: Synchronization type <ul style="list-style-type: none"> • From version 02.00 	Settings of the synchronisation method for the mailbox communication.
	0 Free run	The slave application runs independently of the EtherCAT cycle time.
0x1C32:002	Sync Manager 2: Cycle time <ul style="list-style-type: none"> • Read only: x ns • From version 02.00 	Display of the cycle time for the mailbox communication.
0x1C32:003	Sync Manager 2: Shift time <ul style="list-style-type: none"> • Read only: x ns • From version 02.00 	Display of the time shift for the mailbox communication.
0x1C32:004	Sync Manager 2: Synchronization types supported <ul style="list-style-type: none"> • Read only • From version 02.00 	Display of the available synchronisation method for the mailbox communication. <ul style="list-style-type: none"> • Bit 0 (free run)
0x1C32:005	Sync Manager 2: Minimum cycle time <ul style="list-style-type: none"> • Read only: x ns • From version 02.00 	Display of the minimum cycle time for the mailbox communication.
0x1C33:001	Sync Manager 3: Synchronization type 0 ... [0] ... 65535 <ul style="list-style-type: none"> • From version 02.00 	Setting of the synchronisation method for the input process data (RPDO).
0x1C33:002	Sync Manager 3: Cycle time <ul style="list-style-type: none"> • Read only: x ns • From version 02.00 	Display of the cycle time for the input process data (RPDO).
0x1C33:003	Sync Manager 3: Shift time <ul style="list-style-type: none"> • Read only: x ns • From version 02.00 	Display of the time shift for the input process data (RPDO).
0x1C33:004	Sync Manager 3: Synchronization types supported <ul style="list-style-type: none"> • Read only • From version 02.00 	Display of the available synchronisation method for the input process data (RPDO). <ul style="list-style-type: none"> • Bit 0 (free run)
0x1C33:005	Sync Manager 3: Minimum cycle time <ul style="list-style-type: none"> • Read only: x ns • From version 02.00 	Display of the minimum cycle time for the input process data (RPDO).



8.11.8 EtherCAT - acyclic data transfer

- For configuring and diagnosing the EtherCAT devices, the parameters are accessed by means of acyclic communication.
- Parameter data are transferred as SDOs (Service Data Objects).
- The SDO services enable the writing and reading access to parameters, EtherCAT objects and CiA 402 objects.
- The transfer of parameter data is usually not time-critical.
- Parameter data are, for instance, operating parameters, motor data and diagnostic information.

SDO return values

If an SDO request is evaluated negatively, a corresponding error code is output:

Index	Description
0x00000000	No fault.
0x05030000	The state of the toggle bit has not changed.
0x05040000	SDO protocol time-out.
0x05040001	Invalid or unknown specification symbol for the client/server command.
0x05040005	The space in the main memory is not sufficient.
0x06010000	Unsupported access to an object.
0x06010001	Read access to a write-only object.
0x06010002	Write access to a read-only object.
0x06020000	An object is not available in the object directory.
0x06040041	An object cannot be mapped into the PDO.
0x06040042	The number and/or length of the mapped objects would exceed the PDO length.
0x06040043	General parameter incompatibility.
0x06040047	General internal incompatibility in the device.
0x06060000	The access has failed due to errors in the hardware.
0x06070010	The data type or the parameter length do not match.
0x06070012	Wrong data type: The parameter length is too big.
0x06070013	Wrong data type: The parameter length is too small.
0x06090011	A subindex is not available.
0x06090030	The value range for parameters is too big (only in case of write access).
0x06090031	The parameter value is too high.
0x06090032	The parameter value is too low.
0x06090036	The maximum value is smaller than the minimum value.
0x08000000	General fault.
0x08000020	Data cannot be transferred to the application or saved in the application.
0x08000021	Due to local control, the data cannot be transferred to the application or saved in the application.
0x08000022	Due to the current device state, the data cannot be transferred to the application or saved in the application.
0x08000023	The dynamic object directory generation has failed or no object directory is available.

Configuring the network

EtherCAT

Basic drive control via EtherCAT



8.11.9 Basic drive control via EtherCAT

During commissioning, the EtherCAT master operates as gateway to access from the Engineering PC to the slaves.

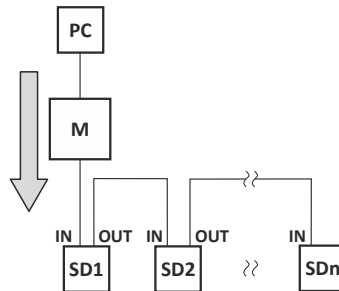

Fig. 7: EtherCAT master as gateway

PC Engineering PC

M Master

SD Slave Device

In the following, the required steps are described to control the device as EtherCAT slave.

Preconditions

- The device is networked as EtherCAT slave to an EtherCAT master and, if necessary, further EtherCAT devices.
- An Engineering PC with an installed »PLC Designer« from V3.12 is connected to the master.
 - Download »PLC Designer«
- On »PLC Designer«-Project with current device description files for EtherCAT is available.
 - Download XML/ESI files for Lenze devices
 - The files are installed via the device repository of the »PLC Designer« (menu command "Tools → Device Repository").
- All EtherCAT devices are supplied with voltage and are switched on.

Short setup

- With the »PLC Designer« from V3.12, the CiA 402 operating mode "CiA: Velocity mode" is automatically activated.
- In the operating mode "CiA: Velocity mode", the setpoint speed defined via the "Target velocity" [0x6042 \(P781.00\)](#) parameter is used.
- A changeover to an alternative setpoint source via CiA: Controlword ([0x6040](#)) is not possible.
- CiA: Controlword ([0x6040](#)) serves to start/stop the EtherCAT device.
- Standard configuration of the PDOs in the CiA 402 operating mode "CiA: Velocity mode":
 - ▶ [EtherCAT - cyclic data transfer](#) [349](#)
- CiA 402 objects: ▶ [Device profile CiA 402](#) [426](#)



How to configure the network:

1. Activate network control in the inverter.

1. Activate network control: `0x2631:037 (P400.37) = "TRUE [1]"`
2. Set network as standard setpoint source: `0x2860:001 (P201.01) = "Network [5]"`
The network control is now activated.

Further information on this: [► General network settings](#)  298

3. Save parameter settings: `0x2022:003 (P700.03) = "On / start [1]"`

2. Configure the master for the gateway function.

1. Start the »PLC Designer«.
2. On »PLC Designer« project.
3. Open the "Communication settings" tab of the master.
4. Click "Add gateway".

Do the following in the appearing dialog window:

- a) Enter the IP address of the master.
 - b) Confirm the entry with "OK".
5. Click "Search network".
 6. Select the corresponding master for the previously entered IP address.
 7. Click "Set active path".
 8. Log into the master using the "Online → Log in" menu command or with `<Alt>+<F8>`.
Now you can access the slaves from the Engineering PC via the EtherCAT master as gateway.

3. Carry out network scan.

1. Execute the "Start Search" command in the context menu of the master.
The appearing dialog box lists all available EtherCAT devices according to the physical order in the network.
2. Click "Copy all devices into the project".
The physical network structure is reproduced in the »PLC Designer« project.



A proper operation requires that the network topology generated in the project corresponds to the physical order of the EtherCAT nodes in the network. Otherwise, an error message displays which slave (product code) is to be expected at which position.

4. Optionally: Adapt EtherCAT device to the application.

1. Adapt parameter values under the "Settings" and "Parameter list" tabs.
2. Set the PDO mapping under the "Process data" tab.
3. Assign variable names under the "EtherCAT I/O image" by double-clicking the variable fields.
4. Create PLC program.

5. Load the network configuration into the master.

1. Log off: Menu command "Online → Log off" or `<Ctrl>+<F8>`.
2. Compiling: Menu command "Build → Build" or `<F11>`.
3. Log in: Menu command "Online → Log in" or `<Alt>+<F8>`.

The configuration, the parameter settings and the PLC program are loaded into the master. Afterwards, all EtherCAT slaves are initialised.



These steps must be carried out after every change within the »PLC Designer« project. An already available configuration and an available PLC program in the master will be then overwritten.



9 Configuring the process controller

By means of the process controller, a process variable can be regulated, for instance the pressure of a pump. The process controller is also referred to as "PID controller" (PID controller = proportional, integral and differential controller).

The process controller is part of a closed control loop. The variable to be influenced (controlled variable) is measured continuously by means of a sensor and supplied to the inverter as an analog signal (actual value) which, in the inverter, is then compared to the reference value (setpoint). The system deviation resulting therefrom is supplied to the process controller which, on this basis, decelerates or accelerates the motor speed according to the desired dynamic performance of the control loop, so that, for instance, a pump always generates the desired pressure.

Connection plan (example)

The following sample connection plan shows the control of a pump ①. The feedback of the variable (here: pressure) takes place via a pressure transducer ② connected to the analog input 1.

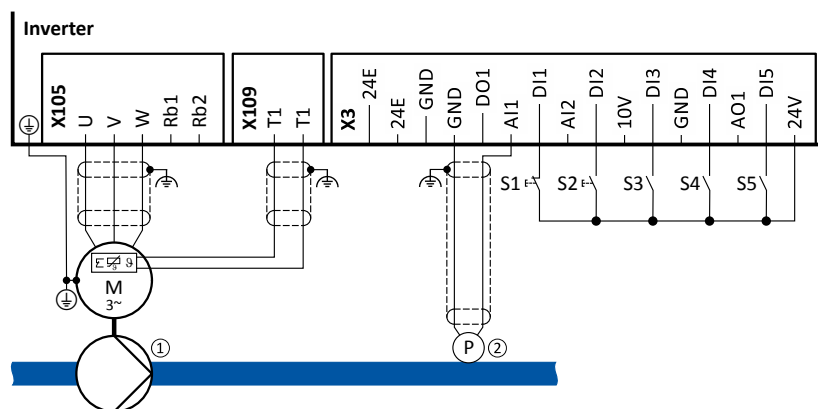

The digital inputs can be used to activate functions of the process controller. The specific assignment of the digital inputs and type of the contacts (switches or buttons, normally-closed contacts or normally-open contacts) depends on the application.

General information on the setting

- The basic setting of the process controller is described in the following subchapter.
 - ▶ [Basic process controller settings](#) 357
- Optionally, the motor can be put into an energy-saving idle state if no power is required.
 - ▶ [Process controller idle state](#) 363
- The rinsing function which can be activated in addition accelerates the motor in idle state to a defined speed at regular intervals. The rinsing of a pipe system with a pump that has been in an inactive state for a longer period is a typical application.
 - ▶ [Process controller rinse function](#) 364



9.1 Basic process controller settings

The process controller is set in two steps:

1. Basic settings
2. Fine adjustment of the PID controller for an optimum control mode

Basic settings

Based on the default setting, we recommend the following proceeding:

1. Activate PID control: Set the desired operating mode (normal or reverse operation) in [0x4020:001 \(P600.01\)](#).
2. If the feedback of the variable is to take place via analog input 2 instead of analog input 1: Set [0x4020:002 \(P600.02\)](#) = "analog input 2 [2]".
3. Configure used analog input:
 - Configure input range.
 - Configure setting range for the PID control.
 - Adapt filter time to minimise impacts of the noise on the variable.
 - Set monitoring response to "No response [0]".
▶ [Configuration of analog inputs](#) [□ 568](#)
4. If a (temporary) change-over to a speed-controlled operation is to be possible via a digital input:
 - Assign a free digital input to the control function "Deactivate PID controller" in [0x2631:045 \(P400.45\)](#). As long as the digital input provides a TRUE signal, the PID control is ignored and the motor is driven in a speed-controlled way.
 - Set acceleration time [0x4021:001 \(P606.01\)](#) and deceleration time [0x4021:002 \(P606.02\)](#) for speed-controlled drive control.
5. Select the standard setpoint source for the reference value in [0x2860:002 \(P201.02\)](#).
 - Functions for setpoint change-over can be used as well. ▶ [Setpoint change-over](#) [□ 514](#)
 - The keypad setpoint can be preset in [0x2601:002 \(P202.02\)](#).
 - If process controller presets are used, they have to be set in [0x4022:001 \(P451.01\)](#) ... [0x4022:008 \(P451.08\)](#).
 - If the analog input is used as setpoint source, it must be configured accordingly. ▶ [Configuration of analog inputs](#) [□ 568](#)
 - If the motor potentiometer is used as setpoint source, this function must be configured accordingly. ▶ [Motor potentiometer setpoint source \(MOP\)](#) [□ 528](#)
6. Set the speed range to be controlled in [0x4020:003 \(P600.03\)](#).
7. If the output value of the process controller is to be limited, adapt the following parameters:
 - [0x4020:005 \(P600.05\)](#): Min speed limit
 - [0x4020:006 \(P600.06\)](#): Max speed limit
8. Try out the following parameters with the default setting and only adapt them if required:
 - [0x404B \(P604.00\)](#): Setpoint ramp
 - [0x404C:001 \(P607.01\)](#): Acceleration time for showing the process controller influence
 - [0x404C:002 \(P607.02\)](#): Deceleration for hiding the process controller influence
9. Diagnostics: Check current reference value and feedback of the variable:
 - The current reference value (setpoint) is displayed in [0x401F:001 \(P121.01\)](#).
 - The current variable (actual value) is displayed in [0x401F:002 \(P121.02\)](#).

After the basic setting of the process controller has been carried out, a fine adjustment of the PID controller must be executed for an optimum control mode (see the following section).

Configuring the process controller

Basic process controller settings



Fine adjustment of the PID controller

The dynamics of the PID controller is parameterised based on the gain of the P component [0x4048 \(P601.00\)](#), the reset time for the I component [0x4049 \(P602.00\)](#) and the gain of the D component [0x404A \(P603.00\)](#). In the default setting, the process controller operates as PI controller, the D component is deactivated.

Basics

- If only the P component is used and the system operates in a steady-state status (reference value is constant and process variable is controlled to a fixed value), a certain system deviation always continues to exist. This remaining system deviation is also called "stationary deviation".
- The I component ensures that no permanent system deviation remains. Here, the reset time [0x4049 \(P602.00\)](#) determines how much the duration of the control deviation influences the control. A high reset time means a lower influence of the I component and vice versa.
- The D component does not respond to the height of the system deviation but to their rate of change only. The D component acts as a "damper" for overshoots. Overshoots may occur if the control tries to respond quickly to changes in the system deviation or the reference value. Thus, the D component reduces the risk of instabilities due to overshoots.



For most applications, the setting of the gain of the P component and the reset time for the I component is sufficient for the fine adjustment. The setting of the gain of the D component may be required for a further stabilisation of the system especially if a quick response to system deviations is to take place.

Execute fine adjustment:

1. Set the reset time for the I component to 6000 ms in [0x4049 \(P602.00\)](#) to deactivate the I component.
 - With this setting and the default setting of [0x404A \(P603.00\)](#), the process controller operates as P controller.
2. Increase gain of the P component step by step in [0x4048 \(P601.00\)](#) until the system gets instable.
3. Reduce gain again until the system is stable again.
4. Reduce gain by another 15 %.
5. Set reset time for the I component in [0x4049 \(P602.00\)](#).
 - With this setting it should be noted that a too low reset time may cause overshoots, especially in case of high steps of the system deviation.
6. Set optional gain of D component in [0x404A \(P603.00\)](#).
 - With this setting it should be noted that the D component responds very sensitively to electrical disturbance on the feedback as well as digitisation errors.



Configuring the process controller

Basic process controller settings

Internal signal flow

The following illustration shows the internal signal flow of the process controller (without the additional functions "idle state" and "rinsing function"):

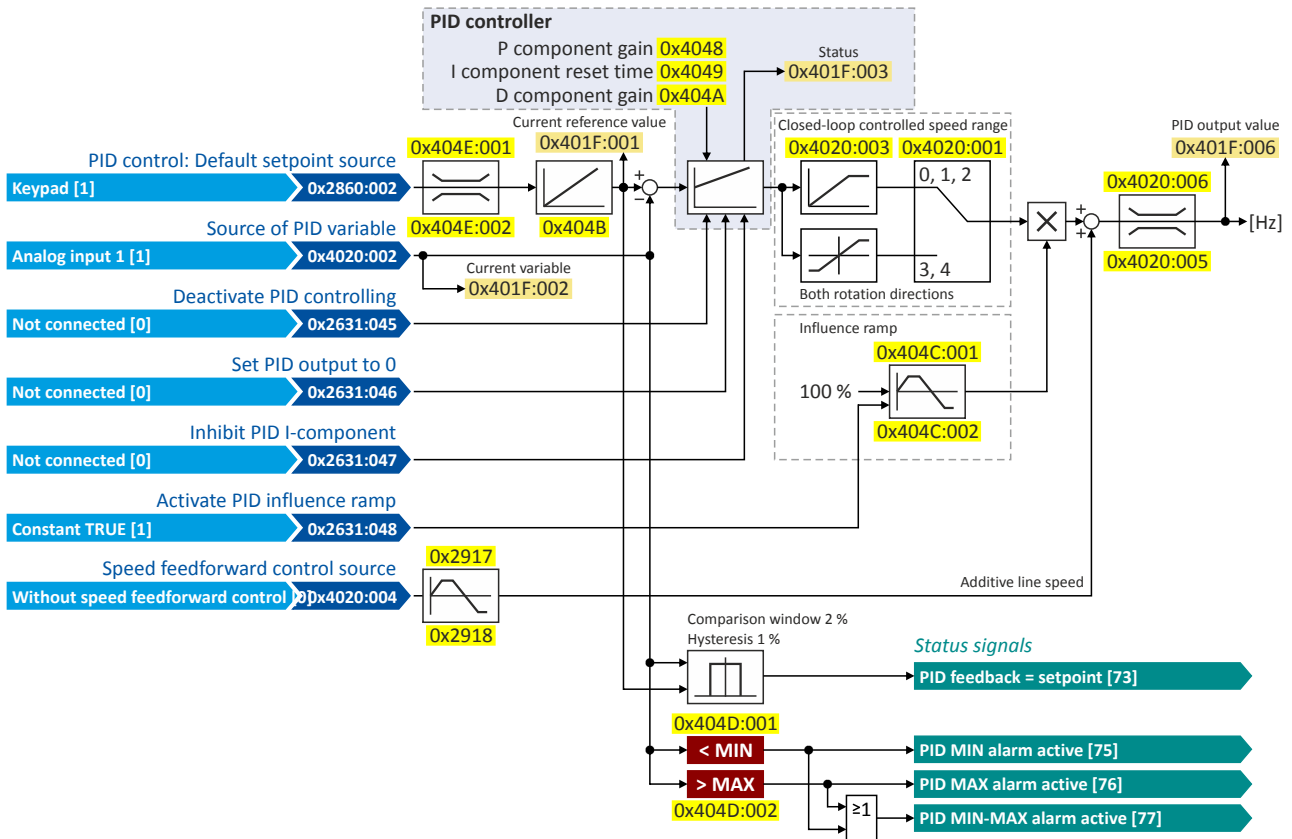

Control functions

The flexible I/O configuration serves to configure different control functions for the process controller:

- 0x2631:045 (P400.45): Deactivate PID controller
- 0x2631:046 (P400.46): Set process controller output to 0
- 0x2631:047 (P400.47): Inhibit process controller I-component
- 0x2631:048 (P400.48): Activate process controller influence ramp

For details see chapter "Process controller function selection". [556](#)

Status signals for configurable outputs

The process controller provides different internal status signals. These status signals can be assigned to the relay, the digital outputs or the NetWordOUT1 status word.

For details see chapter "Configuration of digital outputs". [574](#)

Parameter	Name / value range / [default setting]	Info
0x400B:011 (P592.11)	Process input data: PID feedback (Process data IN: PID feedback) -300.00 ... [0.00] ... 300.00 PID unit • From version 03.00	Mappable parameter for the feedback of the variable (actual value) via network. • Only effective with the selection "Network[5]" in 0x4020:002 (P600.02).

Configuring the process controller

Basic process controller settings



Parameter	Name / value range / [default setting]	Info
0x4020:001 (P600.01)	Process controller setup (PID): Operating mode (PID setup: Operating mode)	Selection of the process controller operating mode.
	0 Inhibited	Process controller deactivated.
	1 Normal operation	The setpoint is higher than the fed back variable (actual value). If the system deviation increases, the motor speed is increased. Example: pressure-controlled booster pumps (increase in the motor speed produces an increase in pressure.)
	2 Reverse operation	The setpoint is lower than the fed back variable (actual value). If the system deviation increases, the motor speed is increased. Example: temperature-controlled cooling water pump (increase in motor speed produces decrease in temperature.)
	3 Normal bi-directional	The direction of rotation corresponds to the sign of the system deviation. If the system deviation increases, the motor speed is increased.
	4 Reverse bi-directional	A negative system deviation causes a positive direction of rotation. If the system deviation increases, the motor speed is increased.
0x4020:002 (P600.02)	Process controller setup (PID): PID process variable (PID setup: PID process var.)	Selection of the source via which the feedback of the controlled variable (actual value) for the process controller is effected.
	1 Analog input 1	
	2 Analog input 2	
	3 DC-bus voltage (from version 02.00)	
	4 Motor Current (from version 02.00)	
	5 Network (from version 02.00)	
	6 HTL input (from version 04.00)	
0x4020:003 (P600.03)	Process controller setup (PID): Closed-loop controlled speed range (PID setup: PID speed range) 0 ... [100] ... 100 %	Setting of the maximum output frequency up to which the process controller carries out regulation. <ul style="list-style-type: none"> 100 % ≡ Maximum frequency 0x2916 (P211.00).
0x4020:004 (P600.04)	Process controller setup (PID): Speed feedforward control source (PID setup: PID line speed)	Optional selection of a speed feedforward control source for the process controller. <ul style="list-style-type: none"> Is advisable, for instance, for dancer position controls if the motor speed must not fall below line speed (process controller output value = line speed + controlled motor speed). Standard applications usually do not require a speed feedforward control; therefore it is deactivated in the default setting.
	0 Without speed addition	
	1 Keypad frequency setpoint	
	2 Analog input 1	
	3 Analog input 2	
	4 Frequency preset 1	
	5 Frequency preset 2	
	6 Frequency preset 3	
	7 Frequency preset 4	
	8 Network	
0x4020:005 (P600.05)	Process controller setup (PID): Min speed limit (PID setup: Min speed lim) -100.0 ... [-100.0] ... 100.0 % <ul style="list-style-type: none"> From version 03.00 	Configuration of the process controller <ul style="list-style-type: none"> 100 % ≡ Maximum frequency 0x2916 (P211.00). The limitation becomes effective after the line speed has been added. The value set here also limits the I component of the PID controller (Integrator-Anti-Windup).
0x4020:006 (P600.06)	Process controller setup (PID): Max speed limit (PID setup: Max speed lim) -100.0 ... [100.0] ... 100.0 % <ul style="list-style-type: none"> From version 03.00 	Maximum output value of the process controller. <ul style="list-style-type: none"> 100 % ≡ Maximum frequency 0x2916 (P211.00). The limitation becomes effective after the line speed has been added. The value set here also limits the I component of the PID controller (Integrator-Anti-Windup).
0x4021:001 (P606.01)	PID speed operation: Acceleration time (PID speed op.: Accel. time) 0.0 ... [1.0] ... 3600.0 s	Acceleration time for (temporary) speed-controlled drive control in process controller mode. <ul style="list-style-type: none"> The acceleration time takes effect at the output of the process controller.
0x4021:002 (P606.02)	PID speed operation: Deceleration time (PID speed op.: Decel. time) 0.0 ... [1.0] ... 3600.0 s	Deceleration time for (temporary) speed-controlled drive control in process controller mode. <ul style="list-style-type: none"> The deceleration time takes effect at the output of the process controller. Exception: In case of quick stop, the quick stop delay time is effective.
0x4048 (P601.00)	PID P-component (PID P-component) 0.0 ... [5.0] ... 1000.0 %	Output frequency of the process controller per 1 % system deviation. <ul style="list-style-type: none"> 100 % ≡ maximum frequency 0x2916 (P211.00).



Configuring the process controller

Basic process controller settings

Parameter	Name / value range / [default setting]	Info
0x4049 (P602.00)	PID I- component (PID I- component) 10 ... [400] ... 6000 ms	Reset time for system deviation. <ul style="list-style-type: none"> With the setting "6000 ms", the I component is deactivated. The I component can also be deactivated via the "Inhibit process controller I-component" 0x2631:047 (P400.47) function.
0x404A (P603.00)	PID D-component (PID D-component) 0.0 ... [0.0] ... 20.0 s	D component, does not respond to the rate of the system deviation, but only to its rate of change.
0x404B (P604.00)	PID setpoint ramp (PID setp.ramp) 0.0 ... [20.0] ... 100.0 s	Acceleration time and deceleration time for the process controller setpoint, relating to the entire setting range of the process controller.
0x404C:001 (P607.01)	PID influence: Acceleration time for showing (PID influence: Show time) 0.0 ... [5.0] ... 999.9 s	If the trigger assigned in 0x2631:048 (P400.48) of the "Activate process controller influence ramp" function is TRUE, the influence of the process controller is shown by means of a ramp with the acceleration time set here.
0x404C:002 (P607.02)	PID influence: Deceleration time for masking out (PID influence: Mask out time) 0.0 ... [5.0] ... 999.9 s	If the trigger assigned in 0x2631:048 (P400.48) of the "Activate process controller influence ramp" function is FALSE, the influence of the process controller is hidden via a ramp with the deceleration time set here.
0x404D:001 (P608.01)	PID alarms: MIN alarm threshold (PID alarms: MIN alarm thrsh.) -300.00 ... [0.00] ... 300.00 PID unit	Trigger threshold for the status signal "PID MIN alarm active [75]". <ul style="list-style-type: none"> The "PID MIN alarm active [75]" status signal is TRUE if the fed back variable (with activated PID control) is lower than the threshold set here. The status signal can be assigned to the relay, a digital output of the NetWordOUT1 status word. ▶ Configuration of digital outputs 574
0x404D:002 (P608.02)	PID alarms: MAX alarm threshold (PID alarms: MAX alarm thrsh.) -300.00 ... [100.00] ... 300.00 PID unit	Trigger threshold for the status signal "PID MAX alarm active [76]". <ul style="list-style-type: none"> The "PID MAX alarm active [76]" status signal is TRUE if the fed back variable (with activated PID control) is higher than the threshold set here. The status signal can be assigned to the relay, a digital output of the NetWordOUT1 status word. ▶ Configuration of digital outputs 574
0x404D:003 (P608.03)	PID alarms: Monitoring bandwidth PID feedback signal (PID alarms: Bandw. feedback) 0.00 ... [2.00] ... 100.00 % <ul style="list-style-type: none"> From version 04.00 	Hysteresis for status signal "PID feedback = setpoint [73]". <ul style="list-style-type: none"> 100 % ≡ configured variable input range Example: Variable input range 0 ... 10 V: 2 % ≡ 0.2 V The status signal "PID feedback = setpoint [73]" is TRUE if the controlled variable fed back = process controller setpoint (± hysteresis set here). The status signal can be assigned to the relay, a digital output of the NetWordOUT1 status word. ▶ Configuration of digital outputs 574
0x404E:001 (P605.01)	PID setpoint limits: Minimum setpoint (PID setp. limit: Minimum setpoint) -300.00 ... [-300.00] ... 300.00 PID unit	Minimum value of the process controller setpoint.
0x404E:002 (P605.02)	PID setpoint limits: Maximum setpoint (PID setp. limit: Maximum setpoint) -300.00 ... [300.00] ... 300.00 PID unit	Maximum value of the process controller setpoint.

Configuring the process controller

Basic process controller settings

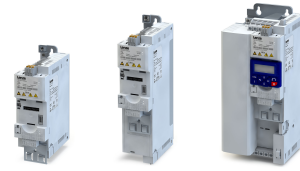

Parameter	Name / value range / [default setting]	Info
0x2860:002 (P201.02)	PID control: Default setpoint source (Std. setpoints: PID setp. src.)	Selection of the standard setpoint source for the reference value of the PID control. <ul style="list-style-type: none"> The selected standard setpoint source is always active with an activated PID control when no setpoint change-over to another setpoint source via corresponding triggers/functions is active.
	1 Keypad	The setpoint is specified locally by the keypad. <ul style="list-style-type: none"> Default setting: 0x2601:002 (P202.02) Use the ↑ and ↓ navigation keys to change the keypad setpoint (also during running operation).
	2 Analog input 1	The setpoint is defined as analog signal via the analog input 1. ▶ Analog input 1 □ 568
	3 Analog input 2	The setpoint is defined as analog signal via the analog input 2. ▶ Analog input 2 □ 572
	4 HTL input (from version 04.00)	The digital inputs DI3 and DI4 can be configured as HTL input to use an HTL encoder as setpoint encoder or define the setpoint as a reference frequency ("pulse train"). ▶ HTL input setpoint source □ 534
	5 Network	The setpoint is defined as process data object via the network. ▶ Configuring the network □ 199
	11 PID preset 1	For the setpoint selection, preset values can be parameterised and selected. ▶ Setpoint source of preset setpoints □ 522
	12 PID preset 2	
	13 PID preset 3	
	14 PID preset 4	
	15 PID preset 5	
	16 PID preset 6	
	17 PID preset 7	
	18 PID preset 8	
	31 Segment preset 1 (from version 03.00)	For the setpoint selection, the segment presets parameterised for the "sequencer" function can be selected as well. ▶ Sequencer □ 462
	32 Segment preset 2 (from version 03.00)	
	33 Segment preset 3 (from version 03.00)	
	34 Segment preset 4 (from version 03.00)	
	35 Segment preset 5 (from version 03.00)	
	36 Segment preset 6 (from version 03.00)	
37 Segment preset 7 (from version 03.00)		
38 Segment preset 8 (from version 03.00)		
50 Motor potentiometer	The setpoint is generated by the "motor potentiometer" function. This function can be used as an alternative setpoint control which is controlled via two signals: "MOP setpoint up" and "MOP setpoint down". ▶ Motor potentiometer setpoint source (MOP) □ 528	
0x401F:003 (P121.03)	Status (PID status) <ul style="list-style-type: none"> Read only 	Bit-coded status display of the process controller.
	Bit 0 Process controller off	
	Bit 1 PID output set to 0	
	Bit 2 PID I-component inhibited	
	Bit 3 PID influence shown	
	Bit 4 Setpoint = actual value	
	Bit 5 Idle state active	
	Bit 6 Reserved	
	Bit 7 Reserved	



Configuring the process controller

Process controller - idle state and rinse function
Process controller idle state

9.2 Process controller - idle state and rinse function

9.2.1 Process controller idle state

If the PID control is activated, this function sets the drive in process controller mode to an energy-saving idle state when no power is required.

Details

A typical application for this function is a booster pump for water in a high-rise building. If no tenant opens the water tap or uses the shower for a longer period of time, the pump changes to the energy-saving idle state. This usually happens at night. The idle state automatically ends as soon as a tenant opens the tap again. The pumps operates normally again until the condition for the idle state is pending again.

The conditions for activating and terminating the idle state can be set independently of one another:

- [0x4023:001 \(P610.01\)](#): Condition for activating the idle state
- [0x4023:006 \(P610.06\)](#): Condition for terminating the idle state

Parameter	Name / value range / [default setting]	Info
0x4023:001 (P610.01)	PID sleep mode: Activation (PID sleep mode: Activation)	Selection of the condition for activating the idle state.
	0 Disabled	Idle state deactivated.
	1 Setpoint < threshold	Activation of idle state if process controller correcting variable < frequency threshold 0x4023:003 (P610.03) longer than the deceleration time 0x4023:005 (P610.05) .
	2 Setpoint < threshold OR process variable > feedback threshold	Activation of idle state if <ul style="list-style-type: none"> • Process controller correcting variable < frequency threshold 0x4023:003 (P610.03) longer than the deceleration time 0x4023:005 (P610.05) OR • fed back variable > feedback threshold 0x4023:004 (P610.04) longer than the deceleration time 0x4023:005 (P610.05).
3 Setpoint < threshold OR process variable < feedback threshold	Activation of idle state if <ul style="list-style-type: none"> • Process controller correcting variable < frequency threshold 0x4023:003 (P610.03) longer than the deceleration time 0x4023:005 (P610.05) OR • fed back variable < feedback threshold 0x4023:004 (P610.04) longer than the deceleration time 0x4023:005 (P610.05). 	
0x4023:002 (P610.02)	PID sleep mode: Stop method (PID sleep mode: Stop method)	Selection of the stop method after activation of the idle state.
	0 Coasting	The motor becomes torqueless (coasts down to standstill).
	1 Deceleration to standstill	The motor is brought to a standstill with deceleration time 1 (or deceleration time 2, if activated). <ul style="list-style-type: none"> • Deceleration time 1 can be set in 0x2918 (P221.00). • Deceleration time 2 can be set in 0x291A (P223.00). ▶ Frequency limits and ramp times □ 129
2 Stop method set	The stop method set in 0x2838:003 (P203.03) is used.	
0x4023:003 (P610.03)	PID sleep mode: Frequency threshold (PID sleep mode: Freq. thresh.) 0.0 ... [0.0] ... 599.0 Hz	Frequency threshold for the activation of the idle state. <ul style="list-style-type: none"> • For comparing "process controller correcting variable < frequency threshold 0x4023:003 (P610.03)" in case of selection 1 ... 3 in 0x4023:001 (P610.01).
0x4023:004 (P610.04)	PID sleep mode: Feedback threshold (PID sleep mode: Feedback thresh.) -300.00 ... [0.00] ... 300.00 PID unit	Feedback threshold for the activation of the idle state. <ul style="list-style-type: none"> • For comparing "fed back variable > feedback threshold 0x4023:004 (P610.04)" in case of selection 2 in 0x4023:001 (P610.01). • For comparing "fed back variable < feedback threshold 0x4023:004 (P610.04)" in case of selection 3 in 0x4023:001 (P610.01).
0x4023:005 (P610.05)	PID sleep mode: Delay time (PID sleep mode: Delay time) 0.0 ... [0.0] ... 300.0 s	Minimum time for which the respective threshold must be underrun or exceeded before the idle state is activated.

Configuring the process controller

Process controller - idle state and rinse function
Process controller rinse function



Parameter	Name / value range / [default setting]	Info
0x4023:006 (P610.06)	PID sleep mode: Recovery (PID sleep mode: Recovery)	Selection of the condition for terminating the idle state.
	0 Setpoint > threshold OR system deviation > bandwidth	Completion of idle state if <ul style="list-style-type: none"> frequency setpoint > (frequency threshold 0x4023:003 (P610.03) + 2 Hz hysteresis) OR in case of active PID control system deviation > bandwidth 0x4023:007 (P610.07) and bandwidth 0x4023:007 (P610.07) <> 0.
	1 Process variable < recovery threshold	Completion of idle state if the controlled variable fed back < completion threshold 0x4023:008 (P610.08).
	2 Process variable > recovery threshold	Completion of idle state if the controlled variable fed back > completion threshold 0x4023:008 (P610.08).
0x4023:007 (P610.07)	PID sleep mode: Bandwidth (PID sleep mode: Bandwidth) 0.00 ... [0.00] ... 300.00 PID unit	Range around the process controller setpoint for terminating the idle state.
0x4023:008 (P610.08)	PID sleep mode: Recovery threshold (PID sleep mode: Recovery thresh.) -300.00 ... [0.00] ... 300.00 PID unit	Termination threshold for idle state.

9.2.2 Process controller rinse function

This function accelerates the motor in idle state of the process controller at regular intervals to a defined speed.

Details

A typical application for this function is the rinsing of a pipe system with a pump that has been in an inactive state for a longer period to prevent deposits.

- In order to activate the rinsing function, set the selection "Enabled [1]" in 0x4024:001 (P615.01).
- The following diagram demonstrates the function:

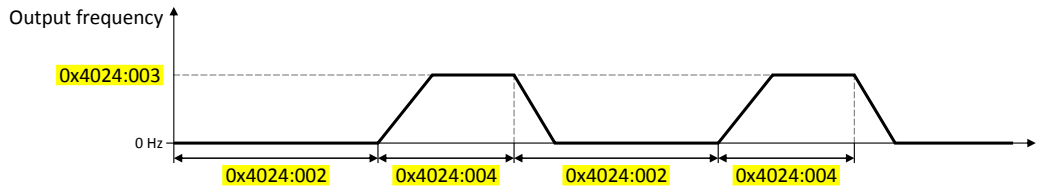

- The rinsing function uses the ramp times set for the "MS: Velocity mode". ▶ [Frequency limits and ramp times](#) 129

Parameter	Name / value range / [default setting]	Info
0x4024:001 (P615.01)	Automatic rinsing: Rinsing in idle state (Auto-rinsing: Rinsing in idle)	1 = activate automatic rinsing in idle state.
	0 Inhibited	
	1 Enabled	
0x4024:002 (P615.02)	Automatic rinsing: Rinse interval (Auto-rinsing: Rinse interval) 0.0 ... [30.0] ... 6000.0 min	Time interval between two rinsing processes.
0x4024:003 (P615.03)	Automatic rinsing: Rinse speed (Auto-rinsing: Rinse speed) -599.0 ... [0.0] ... 599.0 Hz	Speed setpoint for rinse function.
0x4024:004 (P615.04)	Automatic rinsing: Rinse period (Auto-rinsing: Rinse period) 0.0 ... [0.0] ... 6000.0 s	Duration of a rinsing process.



10 Additional functions

- [Device Commands](#) 366
- [Keypad](#) 371
- [Wireless LAN \(WLAN\)](#) 375
- [DC braking](#) 386
- [Brake energy management](#) 391
- [Load loss detection](#) 397
- [Access protection](#) 398
- [Favorites](#) 407
- [Parameter change-over](#) 412
- [Device profile CiA 402](#) 426
- [Holding brake control](#) 429
- [Flying restart circuit](#) 438
- [Timeout für fault reaction](#) 440
- [Automatic restart](#) 441
- [Mains failure control](#) 442
- [Process data](#) 447
- [Encoder settings](#) 449
- [Firmware download](#) 455
- [Additive voltage impression](#) 457
- [Parameter for engineering tools](#) 459

Additional functions

Device Commands
Reset parameters to default



10.1 Device Commands

Device commands are commands for calling organisational functions of the inverter, e.g. saving and loading of parameter settings, or restoring the default setting.

10.1.1 Reset parameters to default

With the "Load default settings" device command, all parameters can be reset to the default setting.



By executing this device command, all parameter settings made by the user are lost!

Details

- All parameters in the RAM memory of the inverter are set to the default setting stored in the firmware of the inverter. (The persistent parameters in the memory module remain unaffected by this measure.)

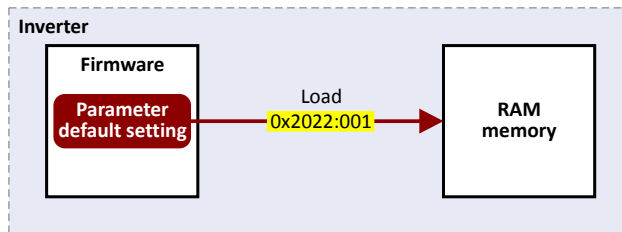

- Afterwards the inverter can be parameterised again on the basis of this initial state.
- Typical application: incorrect or unknown parameter settings.
- The device command only has an effect on the RAM. For a permanent acceptance of the changes made, the data must be saved in the memory module. [▶ Saving/loading the parameter settings](#) [□ 367](#)

Parameter	Name / value range / [default setting]	Info
0x2022:001 (P700.01)	Device commands: Load default settings (Device commands: Load def. sett.) <ul style="list-style-type: none"> Setting can only be changed if the inverter is inhibited. 	<ul style="list-style-type: none"> 1 ≙ reset all parameters in the RAM memory of the inverter to the default setting that is stored in the inverter firmware. All parameter changes made by the user are lost during this process! It may take some seconds to execute the task. When the task has been executed successfully, the value 0 is shown. Loading parameters has a direct effect on the cyclic communication: The data exchange for control is interrupted and a communication error is generated.
	0 Off / ready	Only status feedback
	1 On / start	Execute device command
	2 In progress	Only status feedback
	3 Action cancelled	
	4 No access	
	5 No access (Inverter disabled)	



10.1.2 Saving/loading the parameter settings

If parameter settings of the inverter are changed, these changes at first are only made in the RAM memory of the inverter. In order to save the parameter settings with mains failure protection, the inverter is provided with a pluggable memory module and corresponding device commands.

Details

The memory module is provided with two memories, the user memory and the OEM memory.

User memory

The user memory is used as power-failure-proof storage of parameter settings made by the user during commissioning/operation.

- The SET display is blinking on the keypad if a parameter setting has been changed but has not been saved in the memory module with mains failure protection. In order to save parameter settings in the user memory of the memory module, press the keypad "Enter" key > 3 s.

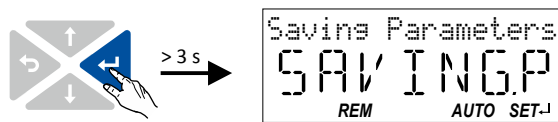

- Parameter settings carried out with »EASY Starter« or via network must be explicitly saved in the user memory by means of the "Save user data" device command, so that the changes carried out are not lost when the mains of the inverter are switched.
- Saving can also be made in the »EASY Starter« via the button or the <F6> function key.
- The device command "Load user data" serves to reload the data from the user memory into the RAM.

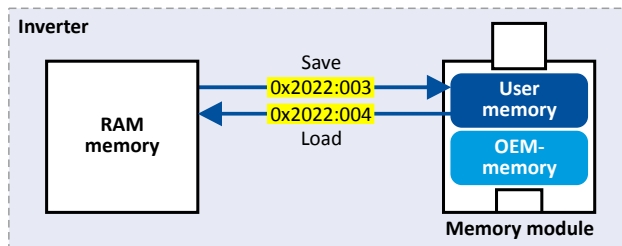

OEM memory

The OEM memory is provided for the storage of customised parameter settings by the OEM/mechanical engineer. If the user carries out parameter settings with the keypad, they are always saved in the user memory if the keypad Enter key is clicked longer than 3 s. The OEM memory remains unaffected by these changes.

- With the "Load OEM data" device command, the parameter settings preconfigured by the OEM/mechanical engineer can be reloaded to the RAM memory of the inverter anytime, if required.
- For saving parameter settings in the OEM memory, the "Save OEM data" device command must be executed explicitly. The parameter settings are simultaneously saved in the user memory.

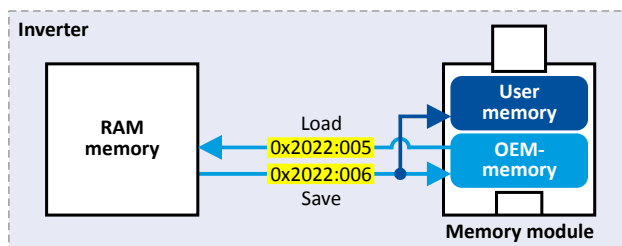

Additional functions

Device Commands

Saving/loading the parameter settings

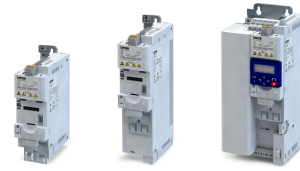

Response after initial switch-on of the inverter

After switch-on, the inverter first tries to load the parameter settings stored in the user memory. If the user memory is empty or damaged, an error message is output and the user must intervene:

- Option 1 = user memory empty: → default setting is loaded automatically from the firmware → data are saved automatically in the user memory of the memory module.
- Option 2 = user- memory damaged: → Error message → default setting is loaded automatically → data are saved automatically in the user memory of the memory module.
- Option 3 = OEM memory empty/damaged: → error message → data are loaded automatically from the user memory of the memory module.

Parameter	Name / value range / [default setting]	Info
0x2022:003 (P700.03)	Device commands: Save user data (Device commands: Save user data) <ul style="list-style-type: none"> • For further possible settings, see parameter 0x2022:001 (P700.01). 366 	1 = save current parameter settings in the main memory of the memory module with mains failure protection. <ul style="list-style-type: none"> • It may take some seconds to execute the task. When the task has been executed successfully, the value 0 is shown. • Do not switch off the supply voltage during the saving process and do not unplug the memory module from the inverter! • When the inverter is switched on, all parameters are automatically loaded from the main memory of the memory module to the RAM memory of the inverter.
	0 Off / ready	Only status feedback
0x2022:004 (P700.04)	Device commands: Load user data (Device commands: Load user data) <ul style="list-style-type: none"> • Setting can only be changed if the inverter is inhibited. • For further possible settings, see parameter 0x2022:001 (P700.01). 366 	1 = load data from the main memory of the memory module to the RAM memory of the inverter. <ul style="list-style-type: none"> • When the device command has been executed successfully, the value 0 is shown. • Loading parameters has a direct effect on the cyclic communication: The data exchange for control is interrupted and a communication error is generated.
	0 Off / ready	Only status feedback
0x2022:005 (P700.05)	Device commands: Load OEM data (Device commands: Load OEM data) <ul style="list-style-type: none"> • Setting can only be changed if the inverter is inhibited. • For further possible settings, see parameter 0x2022:001 (P700.01). 366 	1 = load data from the OEM memory of the memory module to the RAM memory of the inverter. <ul style="list-style-type: none"> • When the device command has been executed successfully, the value 0 is shown. • Loading parameters has a direct effect on the cyclic communication: The data exchange for control is interrupted and a communication error is generated.
	0 Off / ready	Only status feedback
0x2022:006 (P700.06)	Device commands: Save OEM data (Device commands: Save OEM data) <ul style="list-style-type: none"> • For further possible settings, see parameter 0x2022:001 (P700.01). 366 	1 = save current parameter settings in the OEM memory of the memory module with mains failure protection. <ul style="list-style-type: none"> • At the same time, the parameter settings are saved in the main memory of the memory module. • After successful execution, the value 0 is shown.
	0 Off / ready	Only status feedback
0x2829 (P732.00)	Automatic storage in the memory module (Auto-Save EPM)	1 = activate automatic saving of parameters in the memory module. <ul style="list-style-type: none"> • With the setting 0, the "Save user data" 0x2022:003 (P700.03) device command must be explicitly executed, or the "Enter" keypad key must be pressed for longer than 3 s to save the current parameter settings in the memory module of the inverter with mains failure protection.
	0 Inhibit	
	1 Enable	

Related topics

▶ [Data handling](#) [115](#)



10.1.3 Device commands for parameter change-over

The inverter supports several parameter sets. The parameter set can be selected by means of the device commands "Load parameter set 1" ... "Load parameter set 4".

⚠ DANGER!

Changed parameter settings can become effective immediately depending on the activating method set in [0x4046 \(P755.00\)](#).

The possible consequence is an unexpected response of the motor shaft while the inverter is enabled.

- ▶ If possible, only carry out parameter changes while the inverter is disabled.
- ▶ Certain device commands or settings which might cause a critical state of the drive behaviour can generally only be carried out when the inverter is inhibited.

Details

The "parameter change-over" function provides a change-over between four sets with different parameter values for up to 32 freely selectable parameters. For details on the compilation of the parameters and setting of the value sets, see the chapter "[Parameter change-over](#)".

[□ 412](#)

The change-over via the device commands depends on the activation method set in [0x4046 \(P755.00\)](#):

- Activation method = 1 or 3: Change-over takes place immediately.
- Activation method = 0 or 2: The respective device command is only executed if the inverter is disabled.

Parameter	Name / value range / [default setting]	Info
0x2022:007 (P700.07)	Device commands: Load parameter set 1 (Device commands: Load par. set 1) • For further possible settings, see parameter 0x2022:001 (P700.01) . □ 366	1 = load value set 1 of the "Parameter change-over" function. • The parameters specified in 0x4041/1...32 are set to the values set in 0x4042/1...32. • After successful execution, the value 0 is shown. ▶ Parameter change-over □ 412
	0 Off / ready	Only status feedback
0x2022:008 (P700.08)	Device commands: Load parameter set 2 (Device commands: Load par. set 2) • For further possible settings, see parameter 0x2022:001 (P700.01) . □ 366	1 = load value set 2 of the "Parameter change-over" function. • The parameters specified in 0x4041/1...32 are set to the values set in 0x4043/1...32. • After successful execution, the value 0 is shown. ▶ Parameter change-over □ 412
	0 Off / ready	Only status feedback
0x2022:009 (P700.09)	Device commands: Load parameter set 3 (Device commands: Load par. set 3) • For further possible settings, see parameter 0x2022:001 (P700.01) . □ 366	1 = load value set 3 of the "Parameter change-over" function. • The parameters specified in 0x4041/1...32 are set to the values set in 0x4044/1...32. • After successful execution, the value 0 is shown. ▶ Parameter change-over □ 412
	0 Off / ready	Only status feedback
0x2022:010 (P700.10)	Device commands: Load parameter set 4 (Device commands: Load par. set 4) • For further possible settings, see parameter 0x2022:001 (P700.01) . □ 366	1 = load value set 4 of the "Parameter change-over" function. • The parameters specified in 0x4041/1...32 are set to the values set in 0x4045/1...32. • After successful execution, the value 0 is shown. ▶ Parameter change-over □ 412
	0 Off / ready	Only status feedback

Additional functions

Device Commands
Delete logbook



10.1.4 Delete logbook

By means of the "Delete logbook" device command, all logbook entries can be deleted.

Parameter	Name / value range / [default setting]	Info
0x2022:015 (P700.15)	Device commands: Delete logbook (Device commands: Delete logbook) <ul style="list-style-type: none">Setting can only be changed if the inverter is inhibited.	1 = delete all entries in the logbook.
	0 Off / ready	
	1 On / start	

Related topics

▶ [Logbook](#) 86



10.2 Keypad

For the keypad various settings can be made, which are described in detail in the following subchapters.

10.2.1 Keypad language selection

Parameter	Name / value range / [default setting]	Info
0x2863 (P705.00)	Keypad language selection (KP language)	Language selection for the keypad display.
	0 No language selected	
	1 English	
	2 German	

10.2.2 Keypad setpoint increment

Parameter	Name / value range / [default setting]	Info
0x2862 (P701.00)	Keypad setpoint increment (KP setp. incr.) 1 ... [1] ... 100	<p>Adaptation of the increment for keypad setpoints when a keypad arrow key is pressed once. The value set serves as a multiplier for the preset increments.</p> <p>Preset increments:</p> <ul style="list-style-type: none"> • 0.1 Hz for frequency setpoint 0x2601:001 (P202.01). • 0.01 PUnit for process controller setpoint 0x2601:002 (P202.02). • 1 % for torque setpoint 0x2601:003 (P202.03). <p>Notes:</p> <ul style="list-style-type: none"> • With a setting > 1, the option of repeatedly changing the setpoint by pressing the key for a longer time is deactivated. • The setting only has an impact on the keypad setpoints. <p>Example: with the setting "5", the keypad frequency setpoint is increased/decreased by 0.5 Hz every time the key is pressed.</p>

10.2.3 Keypad scaling of speed display

Parameter	Name / value range / [default setting]	Info
0x4002 (P702.00)	Speed display scaling (Scal.speed fact.) 0.00 ... [0.00] ... 650.00	<p>Factor for the scaling of the speed display in 0x400D (P101.00).</p> <ul style="list-style-type: none"> • With the setting "0.00", no scaling takes place. • Example: with the "16.50" and the actual frequency = 50 Hz, 0x400D (P101.00) shows the speed "825 rpm".
0x400D (P101.00)	Scaled actual value (Scaled act value) • Read only: x Units	Display of the current speed in application units.

10.2.4 Keypad status display

During operation, the keypad displays the output frequency of the inverter, or with an active PID control it shows the process controller setpoint. Alternatively, an optional diagnostic parameter can be displayed during operation.

Parameter	Name / value range / [default setting]	Info
0x2864 (P703.00)	Keypad status display (KP status displ.) 0x00000000 ... [0x00000000] ... 0xFFFFFFFF	<p>0 = normal display depending on the operating mode</p> <ul style="list-style-type: none"> • In case of an active frequency control, the keypad displays the output frequency of the inverter. • In case of active PID control, the keypad displays the current Process controller setpoint in [P-Unit]. <p>As an alternative, an optional diagnostic parameter can be set here, which is to be shown on the keypad during operation.</p> <ul style="list-style-type: none"> • Format: 0xiiii00 (iiii = hexadecimal index, ss = hexadecimal subindex) • The lowest byte is always 0x00. • The keypad can be used to select the desired diagnostics parameter from a list.

Additional functions

Keypad
Keypad - Configuration of R/F and CTRL buttons

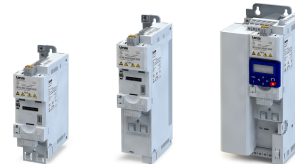

10.2.5 Keypad - Configuration of R/F and CTRL buttons

Keypad rotation setup

Use the $\overset{R}{\curvearrowright}$ keypad to reverse the rotation direction at local keypad control.

- After the $\overset{R}{\curvearrowright}$ key has been pressed, the reversal of rotation direction must be confirmed with the \leftarrow key. (The \rightarrow key serves to cancel the action.)

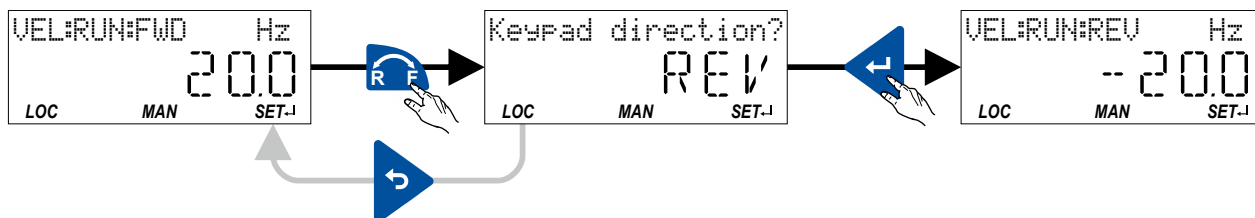

The keypad key $\overset{R}{\curvearrowright}$

- directly changes the keypad rotation setup in [0x2602:002 \(P708.02\)](#).
- has no function in case of a bipolar setpoint selection (e. g. ± 10 V). In this case, the direction of rotation is determined by the sign of the setpoint.
- has no function if the rotation limitation "Only clockwise (CW) [0]" is set in [0x283A \(P304.00\)](#).
- has no function in the operating mode [0x6060 \(P301.00\)](#) = "MS: Torque mode [-1]".
- has no function if the PID control is activated.
- can be deactivated in [0x2602:001 \(P708.01\)](#).



Additional functions

Keypad
Keypad - Configuration of R/F and CTRL buttons

Keypad Full Control



Use the **CTRL** keypad key to activate the "Keypad Full Control" control mode. Both the control and the setpoint selection are then made via the keypad. This special control mode can be, for instance, used during the commissioning phase if external control and setpoint sources are not ready to use yet.

i NOTICE

If the "Keypad Full Control" control mode is active, the "Run" [0x2631:002 \(P400.02\)](#) function is internally set to TRUE.

In this case, the motor cannot be stopped via this function.

► For stopping the motor, use the  keypad key, deactivate the inverter enable or activate the "quick stop" function.

- After the **CTRL** key has been pressed, the activation of the control mode must be confirmed with the  key. (The  key serves to cancel the action.)
- When the control mode is changed over, the motor is first stopped and the "Forward" direction of rotation is set. Then, the motor can be started and stopped via the keypad.

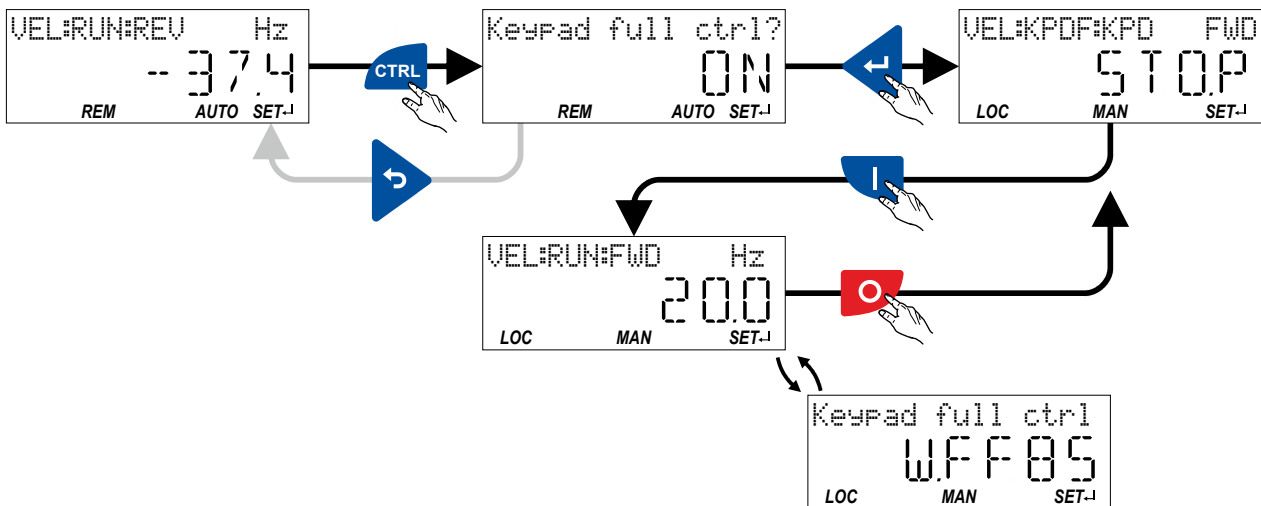

If the "Keypad Full Control" control mode is active,

- the keypad shows the "Keypad full ctrl" warning alternately with the status display.
- the set standard setpoint sources are ignored.
- a change-over to other setpoint sources is not possible.
- a change-over to network control is not possible.
- the following functions continue to be active:
 - [0x2631:001 \(P400.01\)](#): Enable inverter
 - [0x2631:003 \(P400.03\)](#): Activate quick stop
 - [0x2631:005 \(P400.05\)](#): Activate DC braking
 - [0x2631:010 \(P400.10\)](#): Jog forward (CW)
 - [0x2631:011 \(P400.11\)](#): Jog reverse (CCW)
 - [0x2631:013 \(P400.13\)](#): Invert rotation
 - [0x2631:043 \(P400.43\)](#): Activate fault 1
 - [0x2631:044 \(P400.44\)](#): Activate fault 2

Clicking the **CTRL** keypad key stops the control mode again.

The keypad key **CTRL**

- directly changes the setting in [0x2602:003 \(P708.03\)](#).
- can be deactivated in [0x2602:001 \(P708.01\)](#).

Additional functions

Keypad

Keypad - Configuration of R/F and CTRL buttons

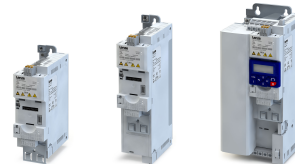

Parameter	Name / value range / [default setting]	Info
0x2602:001 (P708.01)	Keypad setup: CTRL & F/R key setup (Keypad setup: CTRL&F/R keys) • From version 03.00	Disable/enable CTRL and F/R key of the keypad.
	0 CTRL & F/R Disable	
	1 CTRL & F/R Enable	
	2 CTRL Enable F/R Disable	
	3 CTRL Disable F/R Enable	
0x2602:002 (P708.02)	Keypad setup: Keypad rotation setup (Keypad setup: Rotation setup) • From version 03.00	Instructed direction of rotation if local keypad control is active. • If the local keypad control is active, this setting can be directly changed via the keypad key  if the key in 0x2602:001 (P708.01) has not been disabled. • When the remote control is changed over to local keypad control and vice versa, this parameter is set to "Forward [0]".
	0 Forward	
	1 Reverse	
0x2602:003 (P708.03)	Keypad setup: Keypad Full Control (Keypad setup: Keypad Full Ctrl) • From version 03.00	Activate/deactivate full keypad control. • This setting can be changed directly via the keypad key CTRL if the key in 0x2602:001 (P708.01) has not been disabled. • When the control mode is changed over, the motor is stopped and the "Forward" direction of rotation is set.
	0 Off	
	1 On	



Additional functions

Wireless LAN (WLAN)
WLAN LED status displays

10.3 Wireless LAN (WLAN)

The pluggable WLAN module enables

- an easy access to inverters that are installed in difficult access areas,
- an easy parameter setting without cable and instead of the keypad,
- a comfortable monitoring and adaptation of the machine.

The inverter can be accessed via WLAN with the following devices:

- Engineering PC (with WLAN functionality) and the »EASY Starter« engineering tool.
- Android smartphone with Lenze Smart Keypad App.

The Lenze Smart Keypad App is recommended for the adaptation of simple applications. The Lenze Smart Keypad App can be found in the Google Play Store.



10.3.1 WLAN LED status displays

Information on the WLAN module status can be obtained quickly via the LED displays "Power", "TX/RX" and "WLAN" on the front of the WLAN module.

The meaning can be seen from the table below.

LED "Power" (green)	LED "TX/RX" (yellow)	LED "WLAN" (green)	Status/meaning
off	off	off	No supply voltage.
on	on	on	Self-test (duration approx. 1 s)
on	off	off	Ready for operation — no active WLAN connection.
on	Flashing	on	Communication active.
on	off	blinking	Client mode — waiting for connection.
blinking	off	off	Trouble



After being plugged in, the WLAN module needs approx. 20 seconds until it is ready for operation.

Additional functions

Wireless LAN (WLAN)
WLAN basic settings



10.3.2 WLAN basic settings

The WLAN functionality can be configured via the following parameters.

Preconditions

WLAN module has been plugged onto the interface X16 on the front of the inverter.

Details

- The WLAN module can be connected and removed during operation.
- The WLAN module can either create an own WLAN network (access point mode, default setting) or implement itself as a WLAN client in an already existing WLAN network. For details see the following subchapters.
- The WLAN connection is encrypted. The WLAN encryption can be selected in [0x2441:009](#).
- [0x2441:012](#) can be used to set that the name of the WLAN network, called SSID, is not visible for other WLAN devices. As a result, the number of WLAN networks displayed on smartphone or PC can be reduced.
- Two data sources are possible for the WLAN settings: Inverter and WLAN module.
 - Data source - inverter: The WLAN settings saved in the inverter are used. Each inverter has its own WLAN settings.
 - Data source - WLAN module: The WLAN settings saved in the WLAN module are used. In this "stand-alone" mode, the WLAN module can be plugged onto another inverter and then be used with the same settings (irrespective of the WLAN settings of the inverter).
- The data source is activated with [0x2440](#).
- The currently active data source is displayed in [0x2442:004](#).

Parameter	Name / value range / [default setting]	Info
0x2440	Initiate WLAN • From version 02.00	Restart WLAN network with default setting or current settings.
	0 No action/no error	Only status display.
	1 Restart with current values (from version 04.00)	Restart WLAN network with current settings of the WLAN parameters. • The WLAN settings of the active data source (inverter or WLAN module) are used. • The active data source is displayed in 0x2442:004 . • The data source is not changed by this selection. Note! This selection is currently not supported by the WLAN module V1.0.
	2 Restart with default values	Restart WLAN network with default setting of the WLAN parameters. • The WLAN settings saved in the WLAN module are deleted. • Active data source for the WLAN settings is now the inverter.
	11 Restart with current values	Restart WLAN network with current settings of the WLAN parameters. • The current settings are saved in the WLAN module. • Active data source for the WLAN settings is now the WLAN module.
0x2441:004	WLAN settings: DHCP • From version 02.00	1 = Dynamic Host Configuration Protocol (DHCP) is enabled. • In the access point mode, the DHCP server of the WLAN module is activated. • In the client mode, the DHCP-client function is activated.
	0 Disabled	
	1 Enabled	
0x2441:005	WLAN settings: DHCP start address 0 ... [0] ... 4294967295 • From version 02.00	Definition of the start address when the Dynamic Host Configuration Protocol (DHCP) is used. • Only relevant for access point mode. • When 0 is set, the active IP address + 1 is used as start address.
0x2441:006	WLAN settings: WLAN operation mode • From version 02.00	Definition of the operating mode of the WLAN module.
	0 Access point mode	For a direct connection to another WLAN device, the WLAN module creates an own WLAN network. ▶ WLAN access point mode □ 379
	1 Client mode	The WLAN module can be integrated as WLAN client into an already existing WLAN network. ▶ WLAN client mode □ 384



Additional functions

Wireless LAN (WLAN)

WLAN basic settings

Parameter	Name / value range / [default setting]	Info
0x2441:007	WLAN settings: WLAN SSID ["i5"] • From version 02.00	Name (Service Set Identifier, SSID) of the WLAN network. • The preset name consists of the device name (iXXX) and the first 10 digits of the serial number. • Example: "i550_0123456789" • The serial number is displayed in 0x2000:002 (P190.02) .
0x2441:008	WLAN settings: WLAN password ["password"] • From version 02.00	Password (WLAN network key) of the WLAN network. • This password serves to secure the WLAN connections. • The password must have a minimum length of 8 digits. Note! If the WLAN module is to be plugged onto the inverter for a longer period of time, it is important to select a safe password. Otherwise, a potential attacker might connect to the WLAN access point and attack the device and other connected devices or networks. Currently (status: 2016), a WLAN is considered as safe if the password • consists of more than 20 characters, • contains capital and small letters, numbers and special characters and • cannot be found in any dictionary.
0x2441:009	WLAN settings: WLAN security • From version 02.00 0 WPA 1 WPA2	Selection of the WLAN encryption.
0x2441:010	WLAN settings: WLAN access • From version 02.00 0 Disabled (WLAN off) 1 Enabled (WLAN on)	Switch on/off WLAN.
0x2441:011	WLAN settings: WLAN channel • From version 02.00 1 Channel 1 2 Channel 2 3 Channel 3 4 Channel 4 5 Channel 5 6 Channel 6 7 Channel 7 8 Channel 8 9 Channel 9 10 Channel 10 11 Channel 11	Selection of the WLAN channel.
0x2441:012	WLAN settings: WLAN SSID broadcast • From version 02.00 0 Activated 1 Deactivated	1 = the name of the WLAN network, called SSID, is not visible for other WLAN devices.
0x2442:004	Active WLAN settings: Active module mode • Read only • From version 02.00 0 Inverter 1 Standalone	Display of the active data source for the WLAN settings. • This parameter indicates whether the settings used come from the inverter or from the WLAN module. The WLAN settings saved in the inverter are used. The WLAN settings saved in the WLAN module are used.
0x2442:005	Active WLAN settings: MAC address • Read only • From version 02.00	Display of the MAC address of the WLAN module.

Additional functions

Wireless LAN (WLAN)
WLAN basic settings

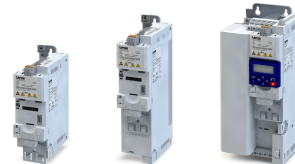

Parameter	Name / value range / [default setting]	Info	
0x2449	WLAN error	Bit coded display of WLAN errors.	
	• Read only		
	• From version 02.00		
	Bit 2		WLAN error
	Bit 3		Memory problem
	Bit 4		WLAN connection problem
	Bit 7		WLAN off
	Bit 9		Client mode off
	Bit 12		TCP/IP configuration error
Bit 13	Password length		
Bit 14	Access denied		

10.3.2.1 Resetting WLAN settings to default setting

Possible reasons:

- Password is not known anymore.
- WLAN SSID is not visible and not known anymore.
- WLAN module mode "stand-alone" shall be deactivated.

0x2440 serves to reset all WLAN settings to the default setting. For this purpose, the inverter must be connected to the »EASY Starter« via the USB module or an existing network.

Option 1: Reset via USB module

How to reset the WLAN settings to default setting by means of the USB module:

Requirements:

- The inverter is ready for operation (supplied with voltage).

Required accessories:

- USB module
- USB 2.0 cable (A-plug on micro B-plug)
- PC with installed »EASY Starter« software

1. Remove the WLAN module from the inverter and plug on the USB module instead.
2. Establish a connection between inverter and »EASY Starter« via the USB module.
3. Set the parameter 0x2440 to "Restart with default values [2]".
4. Remove the USB module from the inverter and plug on the WLAN module instead again.

The default setting is loaded.

Option 2: Reset via network

How to reset the WLAN settings to default setting via network:

Requirements:

- The inverter is ready for operation (supplied with voltage).
- The inverter is connected to a functioning network.

Required accessories:

- PC with installed »EASY Starter«. Moreover, the PC must be connected to the network which also implements the inverter.

1. Establish a connection between the inverter and »EASY Starter« via the used network.
2. Set the parameter 0x2440 to "Restart with default values [2]".

The default setting is loaded.



10.3.3 WLAN access point mode

In the presetting, the WLAN module is configured as WLAN access point because this is the most frequent application. In this operating mode, the WLAN module creates its own WLAN network for a direct connection to other WLAN devices.

The supported WLAN devices are:

- Android smartphone with Lenze Smart Keypad App.
- Engineering PC (with WLAN functionality) and the »EASY Starter« engineering tool.

Details

- In default setting, every inverter with WLAN functionality comes with an individual network name, called SSID.
- The preset network name consists of the device name (iXXX) and the first 10 digits of the serial number (example: "i550_0123456789").
- In the default setting, the password for the WLAN network is called "password" and can be changed in 0x2441:008.



If the WLAN module is to be plugged onto the inverter for a longer period of time, it is important to select a safe password. Otherwise, a potential attacker might connect to the WLAN access point and attack the device and other connected devices or networks. Currently (status: 2016), a WLAN is considered as safe if the password consists of more than 20 characters, contains capital and small letters, numbers and special characters and cannot be found in any dictionary.

The following illustration displays the SSIDs as examples only:

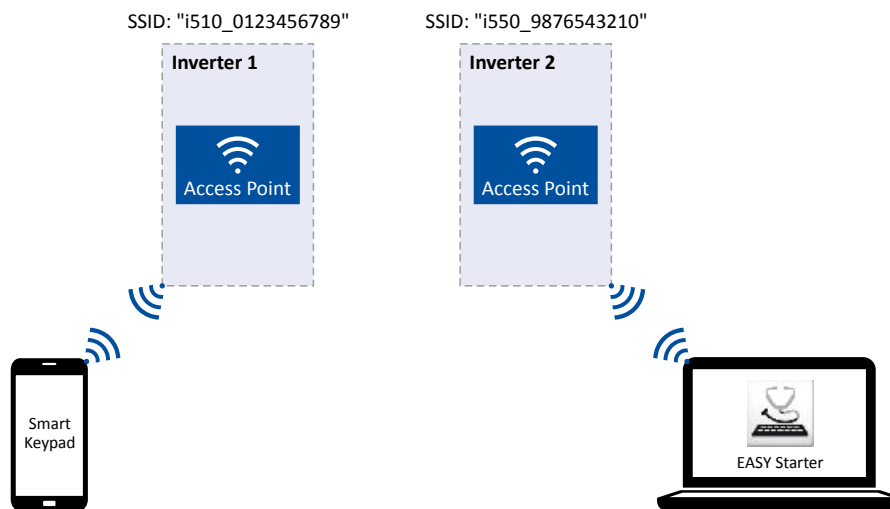

For establishing a WLAN connection, only a few settings are required. The respective setting is described in the following subchapters:

- [Establishing a direct WLAN connection between smartphone and inverter](#) 380
- [Using the smartphone as "Smart Keypad"](#) 381
- [Establishing a direct WLAN connection between Engineering PC and inverter](#) 382

Additional functions

Wireless LAN (WLAN)
WLAN access point mode

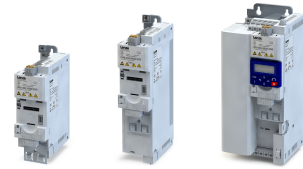

10.3.3.1 Establishing a direct WLAN connection between smartphone and inverter

How to establish a direct WLAN connection to the inverter on the smartphone:

Requirements:

- The functional test described in the mounting and switch-on instructions has been completed successfully (without any errors or faults).
- The inverter is ready for operation (supplied with voltage).

Required accessories:

- WLAN module
- Android smartphone
- Lenze Smart Keypad App (available free of charge in the Google Play Store)

1. Plug the WLAN module onto the front of the inverter (interface X16).
2. Unless already activated, activate the WLAN function on the smartphone under "Settings" → "WLAN".

The WLAN networks available in your range are now displayed.

3. Select the WLAN network established by the inverter.
4. Enter the password for the WLAN network (default setting "password") and click "Connect".

The connection to the WLAN network of the inverter is now established.

5. Start the Lenze Smart Keypad App on the Android smartphone.

If a WLAN connection to the inverter has been established, the Lenze Smart Keypad App serves to

- read out diagnostics parameters of the inverter,
- change parameter settings of the inverter and
- transmit parameter sets.



10.3.3.2 Using the smartphone as "Smart Keypad"

In the default setting, the WLAN settings of the inverters are used. If the WLAN module is plugged onto another inverter, the WLAN connection must be set up again because the replugging causes a change of the network name.

For using the smartphone as "Smart Keypad", the WLAN module can be configured such that the WLAN settings are saved locally in the WLAN module and only these settings are used. In this "standalone" mode, the WLAN module remains permanently coupled to the smartphone because after replugging onto another inverter, the login data for the WLAN network (SSID and password) is the same:

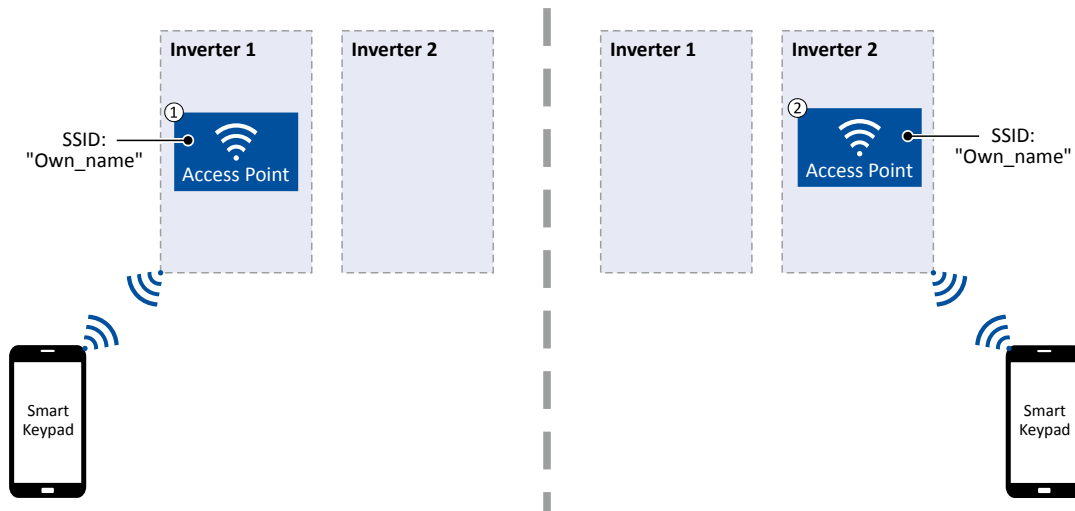

- ① WLAN module is plugged onto the inverter 1. After the connection to the smartphone has been established, the inverter 1 can be diagnosed or parameterised with the Lenze Smart Keypad App.
- ② WLAN module is plugged onto the inverter 2. After the WLAN network is restarted, a connection is established again to the smartphone because the WLAN settings are identical. Now, the inverter 2 can be diagnosed or parameterised with the Lenze Smart Keypad App.

How to configure the WLAN module for a "Smart Keypad" use:

Requirements:

- The WLAN settings of the inverter can be accessed via the Lenze Smart Keypad App or »EASY Starter«.

1. Define your own network name (SSID) in [0x2441:007](#).
2. Define your own password in [0x2441:008](#).
3. Set the selection "Restart with current values [11]" in [0x2440](#).

The defined network name and the password are saved locally in the WLAN module. The WLAN network is restarted with the current settings.

If the WLAN module is then plugged onto another inverter, the settings that are locally saved in the WLAN module are used (irrespective of the WLAN settings of the inverter).

- The active mode ("Inverter" or "Standalone") is displayed in [0x2442:004](#).
- In order to return to the standard mode "Inverter", the selection "Restart with default values [2]" must be set in [0x2440](#).

Additional functions

Wireless LAN (WLAN)
WLAN access point mode

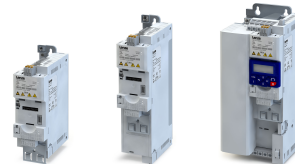

10.3.3.3 Establishing a direct WLAN connection between Engineering PC and inverter

How to establish a direct WLAN connection to the inverter on the Engineering PC:

Requirements:

- The functional test described in the mounting and switch-on instructions has been completed successfully (without any errors or faults).
- The inverter is ready for operation (supplied with voltage).

Required accessories:

- WLAN module
- PC (with WLAN functionality) and installed »EASY Starter«

1. Plug the WLAN module onto the front of the inverter (interface X16).
2. Open the network settings on the Engineering PC: "Control panel" → "Network and sharing center".
3. Select the "Set up a new connection or network" option under "Change your network settings".

The "Set Up a Connection or Network" dialog box is displayed.

4. Select the "Manually connect to a wireless network" connection option and click the "Next" button.

The "Manually connect to a wireless network" dialog box is displayed.

5. Enter the SSID of the inverter as network name.
6. Select "WPA2-Personal" as safety type.
7. Select "AES" as encryption type.
8. Enter the password as safety key for the WLAN network (default setting "password").
9. Tick "Start this connection automatically".
10. Click "Next".

A note indicates that the connection has been added successfully.

11. Click "Close".
12. Start »EASY Starter«.

The "Add devices" dialog is shown.

13. Select the "Ethernet" connection:

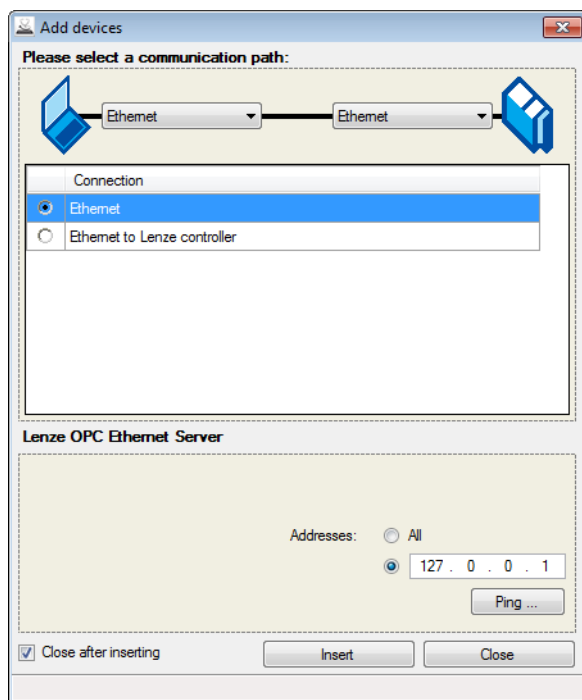

14. Click the **Insert** button.

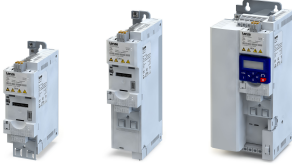

»EASY Starter« searches for connected devices via the communication path selected.

When the connection has been established successfully, the inverter is displayed in the device list of »EASY Starter«. The inverter parameters can now be accessed via the tabs of »EASY Starter«.



Additional functions

Wireless LAN (WLAN)
WLAN access point mode

Recommendation: Click the button in the toolbar of the »EASY Starter«  to start visual tracking. This function serves to quickly check whether the connection to the correct device has been established. ▶ [Optical device identification](#)  135

Additional functions

Wireless LAN (WLAN)
WLAN client mode



10.3.4 WLAN client mode

The WLAN module can be optionally configured as a WLAN client. In this operating mode, the WLAN module can be implemented into an already existing WLAN network.

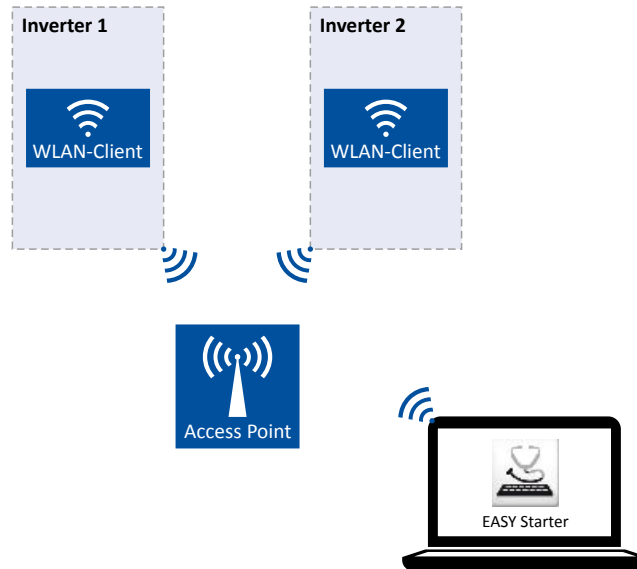

How to configure the WLAN module as WLAN client:

Requirements:

- The WLAN settings of the inverter can be accessed via »EASY Starter«.
- Name (SSID) and password of the external WLAN network are known.

1. Set the selection "Client mode [1]" in [0x2441:006](#).
2. Set the name (SSID) of the external WLAN network in [0x2441:007](#).
3. Set the password of the external WLAN network in [0x2441:008](#).
4. .



Before activating the changed WLAN settings in the next step: Make sure that the name (SSID) and the password of the external WLAN network are set correctly. The restart of the WLAN module in the client mode causes a termination of an existing WLAN connection in the access point mode!

5. Restart the inverter or remove and replug the WLAN module to activate the changed WLAN settings.

The WLAN module now tries as a client to establish a connection to the set external WLAN network.

Notes:

- In the default setting, the WLAN client is configured as DHCP client in [0x2441:004](#).
 - Settings as IP address, subnetwork mask and gateway are automatically made by the DHCP server of the external WLAN network.
 - The active settings are displayed in [0x2442:001](#), [0x2442:002](#) and [0x2442:003](#).
- A static IP configuration can be made via the parameters [0x2441:001](#), [0x2441:002](#) and [0x2441:003](#).

Parameter	Name / value range / [default setting]	Info
0x2441:001	WLAN settings: IP address 0 ... [28485824] ... 4294967295 • From version 02.00	Definition of the IP address for the WLAN access point. <ul style="list-style-type: none"> • In the client mode, a static IP address can be set here for the WLAN client. In order that the static configuration becomes effective, DHCP must be disabled in 0x2441:004. • Byte order is "Big-Endian": 192.168.178.01 ≙ 0x01B2A8C0 (= 28485824)



Additional functions

Wireless LAN (WLAN)
WLAN client mode

Parameter	Name / value range / [default setting]	Info
0x2441:002	WLAN settings: Netmask 0 ... [16777215] ... 4294967295 • From version 02.00	Definition of the network mask for the WLAN access point. • In the client mode, a static network mask can be set here for the WLAN client. In order that the static configuration becomes effective, DHCP must be disabled in 0x2441:004. • Byte order is "Big-Endian": 255.255.255.0 \equiv 0x00FFFFFF (= 16777215)
0x2441:003	WLAN settings: Gateway 0 ... [28485824] ... 4294967295 • From version 02.00	Definition of the gateway for the WLAN access point. • In the client mode, a static gateway can be set here for the WLAN client. In order that the static configuration becomes effective, DHCP must be disabled in 0x2441:004. • Byte order is "Big-Endian": 192.168.178.1 \equiv 0x01B2A8C0 (= 28485824)
0x2442:001	Active WLAN settings: Active IP address • Read only • From version 02.00	Display of the active IP address. • If DHCP is activated, the active IP address usually derives from the configured static IP address of the device.
0x2442:002	Active WLAN settings: Active netmask • Read only • From version 02.00	Display of the active netmask.
0x2442:003	Active WLAN settings: Active gateway • Read only • From version 02.00	Display of the active gateway IP address.
0x2448:001	WLAN status: Connection time • Read only • From version 02.00	Display of the connection time in [s] since the current connection was established.
0x2448:002	WLAN status: Number of connections • Read only • From version 02.00	In access point mode: Display of the number of currently connected clients. In client mode: 0 \equiv not connected; 1 \equiv connected with external WLAN network.
0x2448:003	WLAN status: Rx frame counter • Read only • From version 02.00	Display of the number of request received via WLAN.
0x2448:004	WLAN status: Error statistics • Read only • From version 02.00	Display of the quality of the WLAN connection. A display value > 0 indicates communication problemsn.

Additional functions

DC braking
WLAN client mode



10.4 DC braking

The "DC braking" function generates a braking torque by injecting a DC current into the motor. The function can be used to shorten the braking of a load with high mass inertia. Another application is holding the motor shaft either before starting or while stopping.

i NOTICE

Avoid long-time activation of the "DC braking" function with a high braking current or a high braking voltage!

Possible consequence: thermal motor overload.

- ▶ Only use the "DC braking" function in applications in which the load is only exceptionally stopped.
- ▶ Do not activate the "DC braking" function longer than necessary.

Preconditions

The "DC braking" function is only possible if the inverter is enabled.

Details

The function can be used as follows:

1. Automatically when the motor is started.
2. Automatically when the motor is stopped.
3. Manually (via the flexible I/O configuration).

The three options can also be combined, for instance automatic DC braking when starting and stopping the motor.

For further details and configuration examples, see the following chapter:

- ▶ [Example 1: Automatic DC braking when the motor is started](#) 388
- ▶ [Example 2: Automatic DC braking when the motor is stopped](#) 389
- ▶ [Activating DC braking manually](#) 543

Parameter	Name / value range / [default setting]	Info
0x2B84:001 (P704.01)	DC braking: Current (DC braking: Current) 0.0 ... [0.0] ... 200.0 %	Braking current for DC braking. • 100 % ≙ rated motor current 0x6075 (P323.00)
0x2B84:002 (P704.02)	DC braking: Automatic hold time (DC braking: Hold time autom.) 0.0 ... [0.0] ... 1000.0 s	Hold time for automatic DC braking. • The "Automatic DC braking" function is active for the time set here. • 1000.0 = infinite Note! Do not set this parameter to the value "1000.0" (infinite) if the DC braking is used during the start. The "Infinite" setting can be used to lock the rotor for an indefinite time while a stop is active. However, ensure here that the longer DC braking does not cause a thermal overload of the motor!
0x2B84:003 (P704.03)	DC braking: Automatic operating threshold (DC braking: Threshold autom.) 0.0 ... [0.0] ... 599.0 Hz	Operating threshold for automatic DC braking. • With the setting 0, the "Automatic DC braking" function is deactivated.
0x2B84:004 (P704.04)	DC braking: Demagnetization time (DC braking: Demagnet. time) 0 ... [100] ... 150 % • From version 04.00	In the default setting, the DC braking is activated after the standard demagnetising time has elapsed. This parameter can be used to adapt the time. • 100 % ≙ Default demagnetization time 0x2B84:005 (P704.05) Note! A too short demagnetising time can cause an overcurrent error!
0x2B84:005 (P704.05)	DC braking: Default demagnetization time (DC braking: Def. demag. time) • Read only: x ms • From version 04.00	Display of the standard demagnetising time as a setting help for the user. • This time is calculated by the inverter: Demagnetising time = 7 * rotor time constant



Additional functions

DC braking
WLAN client mode

Parameter	Name / value range / [default setting]	Info
0x2631:005 (P400.05)	Function list: Activate DC braking (Function list: DC braking) <ul style="list-style-type: none"> For further possible settings, see parameter 0x2631:001 (P400.01). □ 500 	Assignment of a trigger for the "Activate DC braking" function. Trigger = TRUE: Activate DC braking. Trigger = FALSE: Deactivate DC braking. ⚠ CAUTION! DC braking remains active as long as the trigger is set to TRUE. ▶ DC braking □ 386
	0 Not connected	No trigger assigned (trigger is constantly FALSE).
0x2838:001 (P203.01)	Start/stop configuration: Start method (Start/stop config: Start method) <ul style="list-style-type: none"> Setting can only be changed if the inverter is inhibited. 	Behaviour after start command.
	0 Normal	After start command, the standard ramps are active. <ul style="list-style-type: none"> Acceleration time 1 can be set in 0x2917 (P220.00). Deceleration time 1 can be set in 0x2918 (P221.00).
	1 DC braking	After start command, the "DC braking" function is active for the time set in 0x2B84:002 (P704.02) . ▶ DC braking □ 386
	2 Flying restart circuit	After the start command, the flying restart circuit is active. The flying restart function makes it possible to restart a coasting motor during operation without speed feedback. Synchronicity between the inverter and motor is coordinated so that the transition to the rotating motor is effected without jerk at the time of connection. ▶ Flying restart circuit □ 438
0x2838:003 (P203.03)	Start/stop configuration: Stop method (Start/stop config: Stop method)	Behaviour after the "Stop" command.
	0 Coasting	The motor becomes torqueless (coasts down to standstill).
	1 Standard ramp	The motor is brought to a standstill with deceleration time 1 (or deceleration time 2, if activated). <ul style="list-style-type: none"> Deceleration time 1 can be set in 0x2918 (P221.00). Deceleration time 2 can be set in 0x291A (P223.00). ▶ Frequency limits and ramp times □ 129
	2 Quick stop ramp	The motor is brought to a standstill with the deceleration time set for the "Quick stop" function. <ul style="list-style-type: none"> Deceleration time for quick stop can be set in 0x291C (P225.00). The "quick stop" function can also be activated manually, for instance via a digital input. ▶ Quick stop □ 132

Additional functions

DC braking

Example 1: Automatic DC braking when the motor is started



10.4.1 Example 1: Automatic DC braking when the motor is started

In order that the DC braking is automatically active when the motor is started, the start method "DC braking [1]" must be set in `0x2838:001 (P203.01)`.

- The DC braking is carried out with the braking current set in `0x2B84:001 (P704.01)`.
- Only after the hold time `0x2B84:002 (P704.02)` has elapsed, the motor is accelerated to the setpoint.

Parameter	Name	Setting for this example
<code>0x2631:001 (P400.01)</code>	Enable inverter	Digital input 1 [11]
<code>0x2631:002 (P400.02)</code>	Run	Digital input 2 [12]
<code>0x2631:004 (P400.04)</code>	Reset fault	Not connected [0]
<code>0x2838:001 (P203.01)</code>	Start method	DC braking [1]
<code>0x2860:001 (P201.01)</code>	Frequency control: Default setpoint source	Frequency preset 1 [11]
<code>0x2911:001 (P450.01)</code>	Frequency setpoint presets: Preset 1	40 Hz
<code>0x2B84:001 (P704.01)</code>	Current	50 %
<code>0x2B84:002 (P704.02)</code>	Automatic hold time	10 s

Input signals

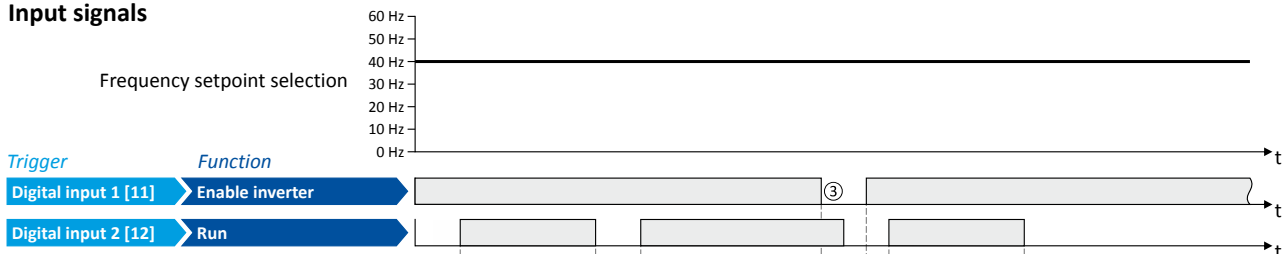

Output signals

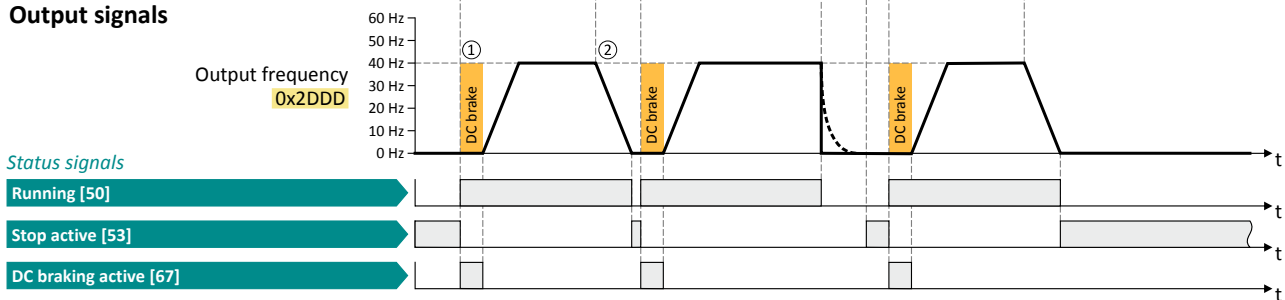

The status signals can be assigned to digital outputs. ▶ [Configuration of digital outputs](#) □ 574

- ① After the start command, the DC braking is active. Only after the hold time `0x2B84:002 (P704.02)` has elapsed, the motor is accelerated to the setpoint.
- ② The motor is stopped with the stop method set in `0x2838:003 (P203.03)`. In the example: Stop with standard ramp.
- ③ If the inverter is disabled, the motor coasts.



Additional functions

DC braking

Example 2: Automatic DC braking when the motor is stopped

10.4.2 Example 2: Automatic DC braking when the motor is stopped

In order that the DC braking is automatically active when the motor is stopped, the corresponding operating threshold must be set in [0x2B84:003 \(P704.03\)](#).

- After a stop command, the motor is first decelerated as set. Only if the output frequency falls below the set operating threshold, the inverter stops the deceleration and activates DC braking.
- DC braking is carried out with the braking current set in [0x2B84:001 \(P704.01\)](#) for the hold time set in [0x2B84:002 \(P704.02\)](#).
- The exact behaviour depends on the stop method set in [0x2838:003 \(P203.03\)](#).

Stop method = "Standard ramp [1]"

Parameter	Name	Setting for this example
0x2631:001 (P400.01)	Enable inverter	Digital input 1 [11]
0x2631:002 (P400.02)	Run	Digital input 2 [12]
0x2631:004 (P400.04)	Reset fault	Not connected [0]
0x2838:003 (P203.03)	Stop method	Standard ramp [1]
0x2860:001 (P201.01)	Frequency control: Default setpoint source	Frequency preset 1 [11]
0x2911:001 (P450.01)	Frequency setpoint presets: Preset 1	40 Hz
0x2B84:001 (P704.01)	Current	50 %
0x2B84:002 (P704.02)	Automatic hold time	10 s
0x2B84:003 (P704.03)	Automatic operating threshold	15 Hz

Input signals

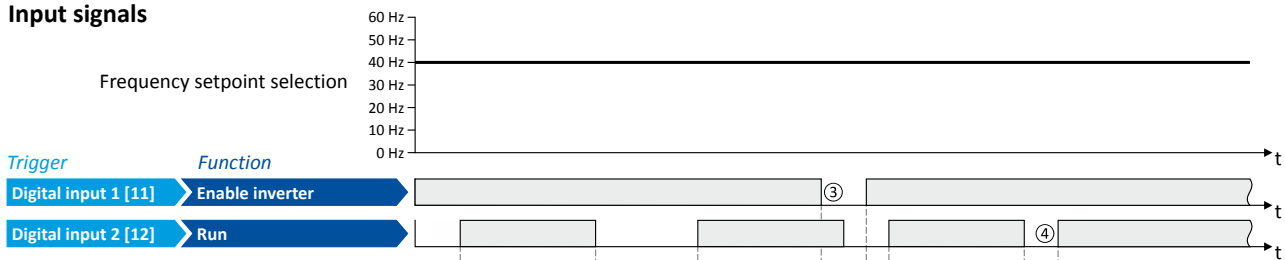

Output signals

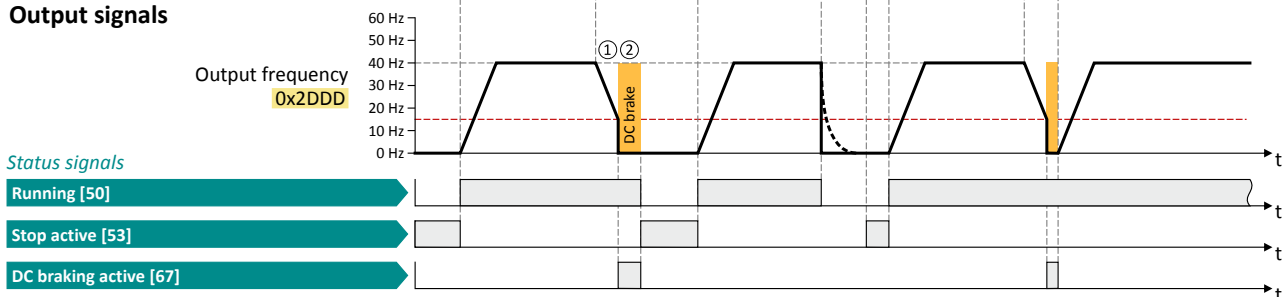

The status signals can be assigned to digital outputs. ▶ [Configuration of digital outputs](#) □ 574

- ① With the stop method "Standard ramp [1]", the motor is first decelerated normally until the value falls below the operating threshold set in [0x2B84:003 \(P704.03\)](#).
- ② The DC braking becomes active for the hold time set in [0x2B84:002 \(P704.02\)](#).
- ③ If the inverter is disabled, the motor coasts. (DC braking is only possible if the inverter is enabled.)
- ④ If there is a new start command within the hold time, the DC braking is cancelled. The motor is accelerated to the setpoint again.

Stop method = "Quick stop ramp [2]"

Same behaviour as with the stop method "Standard ramp [1]", except that the motor is decelerated with the quick stop ramp instead of the standard ramp.

Additional functions

DC braking

Example 2: Automatic DC braking when the motor is stopped



Stop method = "Coasting [0]"

Parameter	Name	Setting for this example
0x2631:001 (P400.01)	Enable inverter	Digital input 1 [11]
0x2631:002 (P400.02)	Run	Digital input 2 [12]
0x2838:003 (P203.03)	Stop method	Coasting [0]
0x2860:001 (P201.01)	Frequency control: Default setpoint source	Frequency preset 1 [11]
0x2911:001 (P450.01)	Frequency setpoint presets: Preset 1	40 Hz
0x2B84:001 (P704.01)	Current	50 %
0x2B84:002 (P704.02)	Automatic hold time	10 s
0x2B84:003 (P704.03)	Automatic operating threshold	15 Hz

Input signals

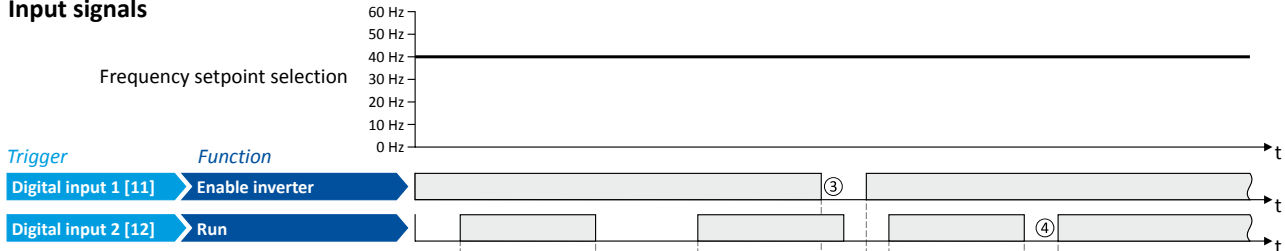

Output signals

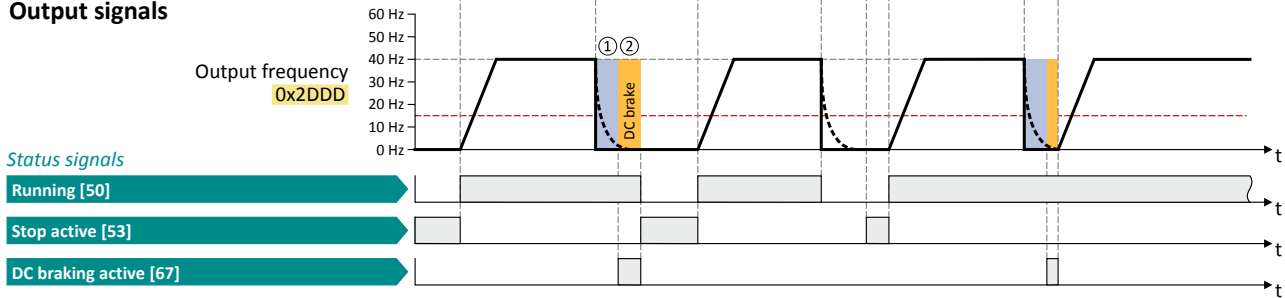

The status signals can be assigned to digital outputs. ▶ [Configuration of digital outputs](#) 574

- ① With the stop method "Coasting [0]", the motor first coasts for a specified time. This "demagnetising time" serves to reduce the induced voltage.
- ② The DC braking becomes active for the hold time set in [0x2B84:002 \(P704.02\)](#).
- ③ If the inverter is disabled, the motor coasts. (DC braking is only possible if the inverter is enabled.)
- ④ If there is a new start command within the hold time, the DC braking is cancelled. The motor is accelerated to the setpoint again.



Additional functions

Brake energy management

Example 2: Automatic DC braking when the motor is stopped

10.5 Brake energy management

When braking electrical motors, the kinetic energy of the drive train is fed back regeneratively to the DC bus. This energy causes a DC-bus voltage boost. If the energy fed back is too high, the inverter reports an error.

Several different strategies can serve to avoid DC-bus overvoltage:

- Use of a brake resistor
- Stopping the deceleration ramp function generator when the active voltage threshold for the brake operation is exceeded
- Use of the "Inverter motor brake" function
- Combination of the above named options
- DC-bus connection

Details

The voltage threshold for braking operation results on the basis of the rated mains voltage set:

Rated mains voltage	Voltage thresholds for braking operation	
	Braking operation on	Braking operation off
230 V	DC 390 V	DC 380 V
400 V	DC 725 V	DC 710 V
480 V	DC 780 V	DC 765 V

The voltage threshold for braking operation can be reduced by 0 ... 100 V. The reduction required must be set in [0x2541:003 \(P706.03\)](#). However, the reduction must be made to such an extent that the reduced voltage threshold is still above the normal stationary DC-bus voltage. The active voltage threshold for the braking operation is displayed in [0x2541:002 \(P706.02\)](#).

If the DC-bus voltage exceeds the voltage threshold for braking operation, the braking method selected in [0x2541:001 \(P706.01\)](#) is applied.

- Optimum following of the actual frequency value to the frequency setpoint (e. g. quick stop of the motor) can always be achieved by the use of a brake resistor.
- Stopping the deceleration ramp function generator enables smoother deceleration with lower torque oscillation.
- The "Inverter motor brake" function allows for quick braking without using a brake resistor. For process-related reasons, torque oscillations may occur.

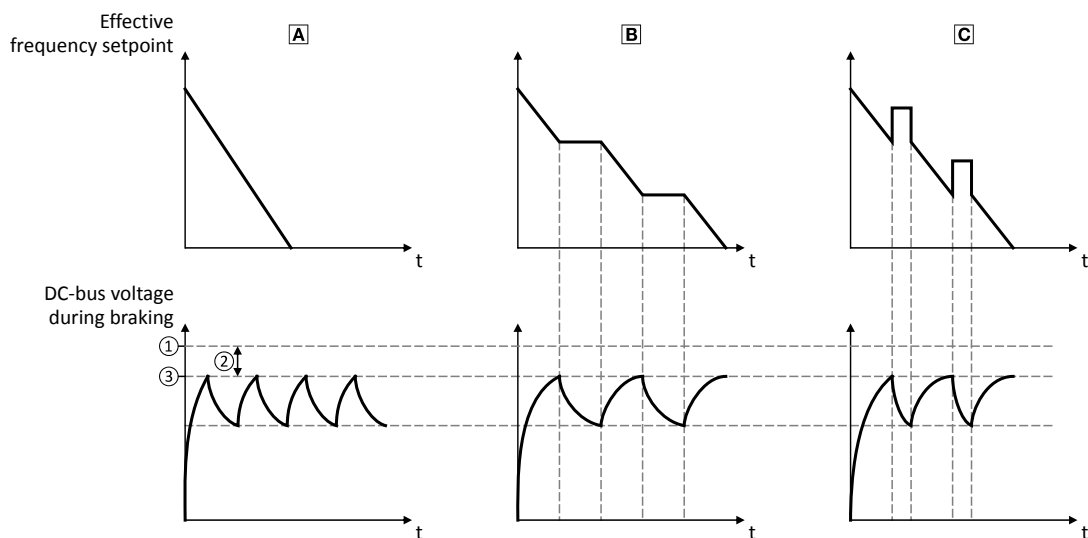

- ① Voltage threshold for braking operation
- ② Reduced threshold [0x2541:003 \(P706.03\)](#)
- ③ Active threshold [0x2541:002 \(P706.02\)](#)

- A** Use of a brake resistor [□ 393](#)
- B** Stopping the deceleration ramp function generator [□ 395](#)
- C** Inverter motor brake [□ 396](#)

Additional functions

Brake energy management

Example 2: Automatic DC braking when the motor is stopped



Parameter	Name / value range / [default setting]	Info
0x2541:001 (P706.01)	Brake energy management: Operating mode (Brake management: Operating mode)	Selection of the braking method. <ul style="list-style-type: none"> The braking method(s) selected is/are activated if the DC-bus voltage exceeds the voltage threshold for the braking operation shown in 0x2541:002 (P706.02).
	0 Brake resistor	The integrated brake chopper (brake transistor) is used. <ul style="list-style-type: none"> ▶ Use of a brake resistor □ 393
	1 Ramp function generator stop (RFGS)	The deceleration ramp function generator is stopped. <ul style="list-style-type: none"> ▶ Stopping the deceleration ramp function generator □ 395
	2 Brake resistor + RFGS	The brake resistor is supplied with current and the deceleration ramp function generator is stopped.
	3 Inverter motor brake (IMB) + RFGS	Braking with the "Inverter motor brake" braking method in connection with "Deceleration ramp function generator stop" is executed. <ul style="list-style-type: none"> ▶ Inverter motor brake □ 396
	4 Brake resistor + IMB + RFGS	Braking is performed by combining all three braking procedures.
0x2541:002 (P706.02)	Brake energy management: Active threshold (Brake management: Active threshold) <ul style="list-style-type: none"> Read only: x V 	Display of the active voltage threshold for the braking operation. <ul style="list-style-type: none"> The voltage threshold shown depends on the mains voltage selected in 0x2540:001 (P208.01) and the voltage value set in 0x2541:003 (P706.03). The voltage threshold must be higher than the stationary DC voltage in the DC bus.
0x2541:003 (P706.03)	Brake energy management: Reduced threshold (Brake management: Red. threshold) 0 ... [0] ... 100 V	The voltage threshold for the braking operation is reduced by the voltage value set here.
0x2541:005 (P706.05)	Brake energy management: Deceleration override time (Brake management: Del. overr. time) 0.0 ... [2.0] ... 60.0 s	Maximum permissible time for the deceleration override by means of the braking method selected in 0x2541:001 (P706.01) . <ul style="list-style-type: none"> If the DC-bus voltage does not fall below the voltage threshold for braking operation shown in 0x2541:002 (P706.02) within this time, the motor is decelerated further. The time is only reset if the voltage threshold shown in 0x2541:002 (P706.02) is not reached.
0x2540:001 (P208.01)	Mains settings: Rated mains voltage (Mains settings: Mains voltage) <ul style="list-style-type: none"> Setting can only be changed if the inverter is inhibited. 	Selection of the mains voltage for actuating the inverter.
	0 230 Veff	
	1 400 Veff	
	2 480 Veff	
	10 230 Veff/reduced LU level	



10.5.1 Use of a brake resistor

For braking operation, optionally the brake chopper integrated in the inverter (brake transistor) can be used.

i NOTICE

Incorrect dimensioning of the brake resistor may result in the destruction of the integrated brake chopper (brake transistor).

- ▶ Only connect a brake resistor complying in terms of performance to terminals R_{B1} and R_{B2} of the inverter.
- ▶ Avoiding thermal overload of the brake resistor.

Preconditions

In order that the integrated brake chopper is activated in the braking operation, one of the following braking methods must be set in [0x2541:001 \(P706.01\)](#):

- "Brake resistor [0]"
- "Brake resistor + RFGS [2]"
- "Brake resistor + IMB + RFGS [4]"

In the default setting of [0x2541:001 \(P706.01\)](#), the integrated brake chopper is not activated in the brake operation!

Details

- The brake resistor required is to be connected to terminals R_{B1} and R_{B2} of the inverter.
- In [0x2541:001 \(P706.01\)](#), additionally the stopping function for the deceleration ramp function generator can be set when the brake resistor is controlled, in order to avoid over-voltage disconnection in the case of lower deceleration times.
- In the default setting and with a disabled inverter and an error status ("Error active"), the brake chopper is switched off. This behaviour can be changed in [0x2541:006 \(P706.06\)](#).
Example: In a DC-bus connection with several inverters, only one brake resistor is used. It is connected to the most powerful inverter in the DC-bus connection. This inverter then serves to change the behaviour so that inverter disable and/or an error does not cause a switch-off of the brake chopper.

Internal protective function

The following protective function prevents the brake chopper from being switched on permanently, e.g. due to too high voltages or wrong settings:

- The brake chopper is switched off if it was switched on over a period of 4 s.
- If the DC-bus voltage again falls below the voltage threshold for braking operation, the brake chopper can again be switched on for maximally 4 s without interruption.

Additional functions

Brake energy management
Use of a brake resistor



Brake resistor monitoring

The inverter calculates and monitors the thermal load of the brake resistor to ensure that the brake resistor will not be overloaded.

A correct calculation required the following settings according to the data on the nameplate of the brake resistor:

- [0x2550:002 \(P707.02\)](#): Resistance value
- [0x2550:003 \(P707.03\)](#): Rated power
- [0x2550:004 \(P707.04\)](#): Maximum thermal load

The calculated thermal load is not displayed in [0x2550:007 \(P707.07\)](#).

The brake resistor monitoring is designed with two stages:

- If the calculated thermal load exceeds the warning threshold set in [0x2550:008 \(P707.08\)](#) (default setting: 90 %), the response set in [0x2550:010 \(P707.10\)](#) takes place (default setting: "Warning"). The warning status will be reset if the thermal load falls below the warning threshold - 20 %.
- If the calculated thermal load exceeds the warning threshold set in [0x2550:009 \(P707.09\)](#) (default setting: 100 %), the response set in [0x2550:011 \(P707.11\)](#) takes place (default setting: "Fault"). The error status will be reset if the thermal load falls below the error threshold - 20 %.

Parameter	Name / value range / [default setting]	Info
0x2541:006 (P706.06)	Brake energy management: Brake resistor response (Brake management: Brk. res. behav)	Behaviour of the integrated brake chopper if the inverter is disabled and if the error status is active.
	• Setting can only be changed if the inverter is inhibited.	
	0 Off: disable and error	If the inverter is disabled and the error status is active, the brake chopper is switched off.
	1 On: disable / off: error	Brake chopper is switched off if the error status is active, but not if the inverter is disabled.
	2 Off: disable / on: error	Brake chopper is switched off if the inverter is disabled but not if the error status is active.
3 On: disable and error	Brake chopper is not switched off if the inverter disabled and the error status is active.	
0x2550:002 (P707.02)	Brake resistor: Resistance value (Brake resistor: Resistance value) 0.0 ... [180.0] * ... 500.0 Ω * Default setting depending on the size.	Resistance value of the brake resistor connected. • The value to be entered can be obtained from the brake resistor nameplate.
0x2550:003 (P707.03)	Brake resistor: Rated power (Brake resistor: Rated power) 0 ... [50] * ... 800000 W * Default setting depending on the size.	Rated power of the brake resistor connected. • The value to be entered can be obtained from the brake resistor nameplate.
0x2550:004 (P707.04)	Brake resistor: Maximum thermal load (Brake resistor: Maximum heat) 0.0 ... [8.0] * ... 100000.0 kW * Default setting depending on the size.	Thermal capacity of the brake resistor connected. • The value to be entered can be obtained from the brake resistor nameplate.
0x2550:007 (P707.07)	Brake resistor: Thermal load (Brake resistor: Thermal load) • Read only: x.x %	Display of the utilisation of the brake resistor connected.
0x2550:008 (P707.08)	Brake resistor: Warning threshold (Brake resistor: Warning thresh.) 50.0 ... [90.0] ... 150.0 %	Warning threshold for brake resistor monitoring. • If the utilisation shown in 0x2541:004 (P706.04) reaches the threshold set, the response selected in 0x2550:010 (P707.10) is effected. • The warning is reset with a hysteresis of 20 %.
0x2550:009 (P707.09)	Brake resistor: Error threshold (Brake resistor: Error thresh.) 50.0 ... [100.0] ... 150.0 %	Error threshold for brake resistor monitoring. • If the utilisation shown in 0x2541:004 (P706.04) reaches the threshold set, the response selected in 0x2550:011 (P707.11) is effected. • Resetting the error is only possible if the hysteresis is lower than 20 %.
0x2550:010 (P707.10)	Brake resistor: Response to warning (Brake resistor: Warning resp.) • For further possible settings, see parameter 0x2D45:001 (P310.01) □ 196	Selection of the response that is executed when the warning threshold for brake resistor monitoring is reached. Associated error code: • 65334 0xFF36 - Brake resistor: overload warning
	1 Warning	▶ Error types □ 113



Additional functions

Brake energy management Stopping the deceleration ramp function generator

Parameter	Name / value range / [default setting]	Info
0x2550:011 (P707.11)	Brake resistor: Response to error (Brake resistor: Error response)	Selection of the response to be executed when the error threshold for brake resistor monitoring is reached.
	<ul style="list-style-type: none"> For further possible settings, see parameter 0x2D45:001 (P310.01). 196 	Associated error code: <ul style="list-style-type: none"> 65282 0xFF02 - Brake resistor: overload fault
	3 Fault	▶ Error types 113

10.5.2 Stopping the deceleration ramp function generator

The deceleration ramp function generator is stopped for a short time if the voltage threshold for braking operation is exceeded.

Details

When this braking method is selected, the maximum permissible time for the deceleration override has to be set in [0x2541:005 \(P706.05\)](#).

- If the DC-bus voltage does not fall below the voltage threshold for braking operation shown in [0x2541:002 \(P706.02\)](#) within this time, the motor is decelerated further.
- The time is only reset if the voltage threshold shown in [0x2541:002 \(P706.02\)](#) is not reached.

Additional functions

Brake energy management
Inverter motor brake



10.5.3 Inverter motor brake

With this braking method, which can be selected in [0x2541:001 \(P706.01\)](#), the regenerative energy in the motor is converted as a result of dynamic acceleration/deceleration with down-ramping of the ramp function generator.

i NOTICE

Too frequent braking may cause thermal overload of the motor.

- ▶ Avoid activating the "Inverter motor brake" function over a longer time!
- ▶ In applications with a high mass inertia and long braking times (> 2 s), use the "DC braking" function.

Preconditions

- The "Inverter motor brake" braking method must not be used with vertical conveyors (hoists) or with active loads!
- The "inverter motor brake" braking method only works in operating mode [0x6060 \(P301.00\)](#) = "MS: Velocity mode [-2]".
- When this braking method is used, the motor overload monitoring is not adapted. A too frequent use of the inverter motor brake may cause an incorrect operation of the motor overload monitoring. ▶ [Motor overload monitoring \(i²*t\)](#) [188](#)

Details

During the deceleration process, the ramp function generator is stopped. The frequency set in [0x2541:004 \(P706.04\)](#) is added to the frequency setpoint, taking the sign of the current actual frequency into consideration. Furthermore the ramp function generator is stopped in a state of overvoltage. If the DC-bus voltage falls below a defined DC-bus voltage potential, the additional frequency connected is reduced again and the ramp function generator is re-activated. By the alternating acceleration and deceleration resulting from this circuit, the energy is converted thermally in the motor. For process-related reasons, torque oscillations may occur.

Setting instructions

Generally, the smallest value possible required by the application for being able to still traverse the load to be moved in a controlled fashion should be set as additional frequency. Greater mass inertia values require an increase in the rated motor frequency set. Increasing the rated motor frequency, however, causes greater torque oscillations. A possible consequence is the reduced service life of mechanical components. Furthermore an increase in the rated motor frequency also increases the energy converted into heat in the motor. A possible consequence is the reduced service life of the motor.

Parameter	Name / value range / [default setting]	Info
0x2541:004 (P706.04)	Brake energy management: Additional frequency (Brake management: Add.frequency) 0.0 ... [0.0] ... 10.0 Hz	Frequency deviation which is connected to the deceleration ramp in a pulsative fashion when the "Inverter motor brake" braking method is used.
0x2C01:005 (P320.05)	Motor parameters: Rated frequency (Motor parameters: Rated frequency) Device for 50-Hz mains: 1.0 ... [50.0] ... 1000.0 Hz Device for 60-Hz mains: 1.0 ... [60.0] ... 1000.0 Hz	General motor data. Carry out settings as specified by motor nameplate data. Note! When you enter the motor nameplate data, take into account the phase connection implemented for the motor (star or delta connection). Only enter the data applying to the connection type selected.

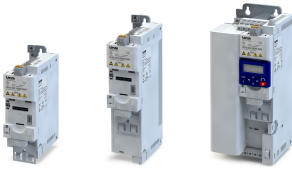

Parameter	Name / value range / [default setting]	Info
0x6060 (P301.00)	Modes of operation (Modes of op.) • Setting can only be changed if the inverter is inhibited.	Selection of the operating mode.
	-2 MS: Velocity mode	Vendor specific velocity mode
	-1 MS: Torque mode (from version 03.00)	Vendor specific torque mode • Only possible in motor control type 0x2C00 (P300.00) = "Sensorless vector control (SLVC) [4]". ▶ Torque control w/ freq. limit □ 179
	0 No mode change/no mode assigned	No operating mode (standstill)
	2 CiA: Velocity mode	CiA 402 velocity mode

10.6 Load loss detection

This function serves to detect a load loss during operation and to then activate a specific function, for instance the switching of the relay.

Details

If, during operation, the current motor current falls below the threshold set in 0x4006:001 (P710.01) for at least the time set in 0x4006:002 (P710.02), the internal status signal "Load loss detected [83]" is set to TRUE:

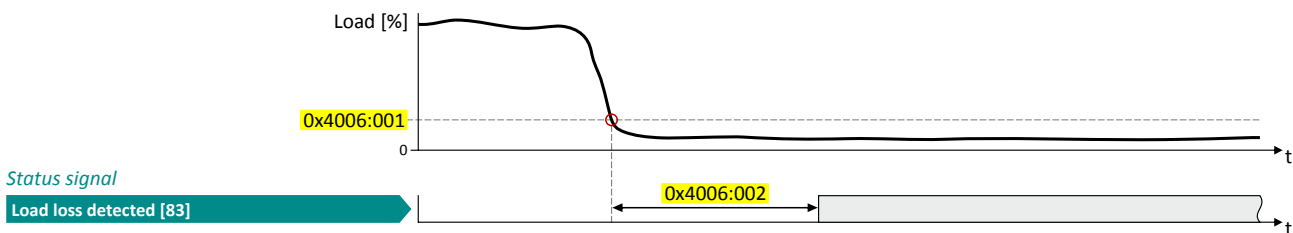

- The threshold is set in percent with reference to the rated motor current "Motor rated current" 0x6075 (P323.00).
- The status signal "Load loss detected [83]" can be assigned, for instance, to a digital output or the relay via the flexible I/O configuration. ▶ Configuration of digital outputs □ 574
- The load loss detection is not active with active DC braking.

Parameter	Name / value range / [default setting]	Info
0x4006:001 (P710.01)	Load loss detection: Threshold (Load loss detect: Threshold) 0.0 ... [0.0] ... 200.0 %	Threshold for load loss detection. • 100 % ≙ rated motor current 0x6075 (P323.00)
0x4006:002 (P710.02)	Load loss detection: Deceleration (Load loss detect: Deceleration) 0.0 ... [0.0] ... 300.0 s	Tripping delay for load loss detection.
0x6075 (P323.00)	Motor rated current (Motor current) 0.001 ... [1.700]* ... 500.000 A * Default setting depending on the size. • Setting can only be changed if the inverter is inhibited.	The rated motor current to be set here serves as a reference value for different parameters with a setting/display of a current value in percent. Example: • Motor rated current = 1.7 A • Max current 0x6073 (P324.00) = 200 % Motor rated current = 3.4 A
0x6078 (P103.00)	Current actual value (Current actual) • Read only: x.x %	Display of the present motor current. • 100 % ≙ Motor rated current 0x6075 (P323.00)

Additional functions

Access protection
Write access protection



10.7 Access protection

10.7.1 Write access protection

Optionally a write access protection can be installed for the inverter parameters.



Write access protection only restricts parameterisation via keypad and »EASY Starter«. Write access protection via network is not restricted. Irrespective of the write access protection that is currently set, a higher-level controller, OPC-UA server, or any other communication partner connected to the inverter is always provided with full read/write access to all parameters of the inverter.



After activating the write access protection, you have to enter a valid PIN to remove the write access protection. Note down the defined PIN(s) and keep this information in a safe place! If you lose the PIN(s), the inverter can only be disabled by resetting it to the delivery status. This means, all parameter settings made by the user get lost! [▶ Reset parameters to default](#) [□ 366](#)

Details

Usually the write access protection function is implemented by the mechanical engineer/OEM, for example to protect the inverter against incorrect parameterisation by non-authorised persons. For diagnostic purposes, a read access to all parameters is always possible.

The write access protection allows for the following configurations:

- Full write access
- Write access only to favorites or (when knowing PIN1) to all parameters
- No write access or (when knowing PIN2) full write access
- No write access or (when knowing PIN1) write access only to favorites or (when knowing PIN2) to all parameters

The following table compares the four possible configurations:

PIN1 setting	PIN2 setting	Log-in	Status display after log-in	Active write access protection (via keypad/»EASY Starter«)
0x203D (P730.00)	0x203E (P731.00)	0x203F	0x2040 (P197.00)	
0	0	-	0	No access protection configured.
Access →				
		Diagnostics (read access)	Favorites	All parameters
> 0	0	0 or wrong PIN	2	Write access only possible to favorites.
		Correct PIN1	0	Write access to all parameters possible.
Access →				
		Diagnostics (read access)	Favorites	All parameters PIN1
0	> 0	0 or wrong PIN	1	No write access.
		Correct PIN2	0	Write access to all parameters possible.
Access →				
		Diagnostics (read access)	Favorites	All parameters PIN2
> 0	> 0	0 or wrong PIN	1	No write access.
		Correct PIN1	2	Write access only possible to favorites.
		Correct PIN2	0	Write access to all parameters possible.
Access →				
		Diagnostics (read access)	Favorites	All parameters PIN1 PIN2
If PIN1 and PIN2 are set identically, a write access to all parameters is possible after the PIN has been entered correctly.				



Additional functions

Access protection
Write access protection

Notes:

- The firmware of the inverter does only support the protection status.
- The access protection is realised by the keypad and engineering tools as "clients" themselves based on the current protection status **0x2040 (P197.00)**.

More details on how to configure the write access protection with the respective client can be found in the following subchapters:

▶ [Write access protection in the »EASY Starter«](#) 400

▶ [Write access protection in the keypad](#) 403

Parameter	Name / value range / [default setting]	Info				
0x203D (P730.00)	PIN1 access protection (PIN1 protection) -1 ... [0] ... 9999	PIN definition for write access protection. <ul style="list-style-type: none"> • 1 ... 9999 = set/change PIN. • 0 = delete PIN (deactivate access protection). 				
0x203E (P731.00)	PIN2 access protection (PIN2 protection) -1 ... [0] ... 9999	<ul style="list-style-type: none"> • When the PIN has been set successfully, the value -1 is shown; otherwise 0. • Setting/changing the PIN via keypad/»EASY Starter« only possible if no write access protection is active. • Settings/changes via »EASY Starter« become effective immediately; via keypad they only become effective when the parameter group has been exited. 				
0x203F	PIN1/PIN2 log-in -32768 ... [0] ... 32767	Parameter for PIN entry for the purpose of deactivating an active access protection temporarily. <ul style="list-style-type: none"> • 1 ... 9999 = log-in (deactivate access protection temporarily). • 0 = log-out (reactivate access protection). • After having logged in successfully, the value 0 is shown; otherwise -1. • After 10 invalid entries, the log-in function is inhibited. In order to remove the log-in inhibit, the inverter must be switched off and on again. 				
0x2040 (P197.00)	Access protection status (Protect. status) <ul style="list-style-type: none"> • Read only <table border="1" style="margin-left: 20px;"> <tr> <td>Bit 0</td> <td>No write access</td> </tr> <tr> <td>Bit 1</td> <td>Only favorites changeable</td> </tr> </table>	Bit 0	No write access	Bit 1	Only favorites changeable	Bit-coded display of the active access protection after login by PIN1/PIN2.
Bit 0	No write access					
Bit 1	Only favorites changeable					

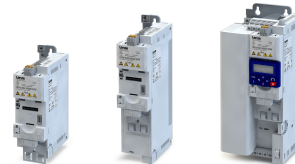

Additional functions

Access protection
Write access protection



10.7.1.1 Write access protection in the »EASY Starter«

If a write access protection is active for the online connected inverter, it is displayed in the status bar of the »EASY Starter«:

Display	Representation of the parameters in the »EASY Starter«
 No write access	All parameters in all dialogs are displayed as read-only parameters.
 Only favorites	Except for the favorites, all parameters in all dialogs are displayed as read-only parameters.

An active write access protection can be removed when the PIN is known.

How to remove an active write access protection temporarily:

1. Click the symbol  in the toolbar.

The "Log in / Log off" dialog box is displayed:

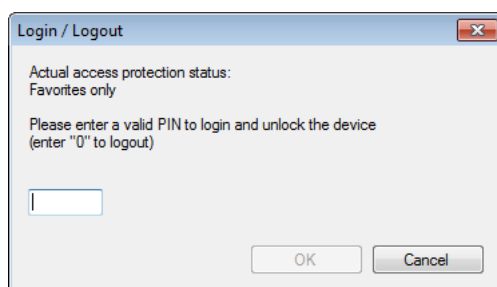

2. Enter the valid PIN and confirm with **OK**.



After 10 invalid entries, the log-in function is inhibited. In order to remove the log-in inhibit, the inverter must be switched off and on again.

The write access protection gets active again:

- Automatically 10 minutes after the last log-in.
- Automatically after the mains voltage is switched on again.
- Manually by entering a "0" in the dialog box "Log in / Log off" (see above).



Configuring the write access protection with »EASY Starter«

The write access protection is activated by specifying PIN1 and/or PIN2 (depending on the desired configuration of the write access protection).

How to activate the write access protection:

1. Go to the "Settings" tab and navigate to the "Access protection" parameterisation dialog:

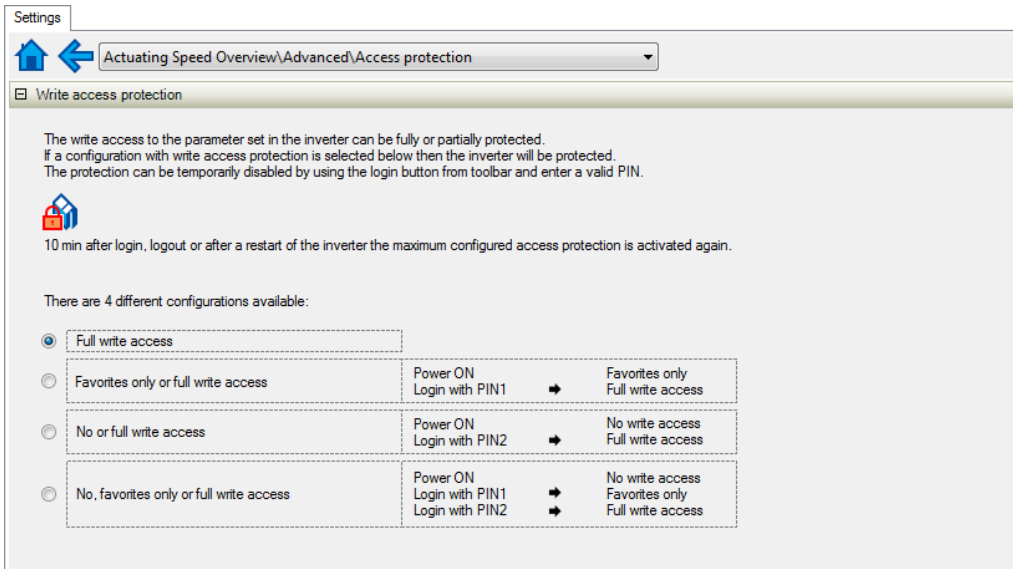

2. Select the desired configuration of the write access protection.

The "PIN definition" dialog box is displayed. The possible entries depend on the selected configuration.

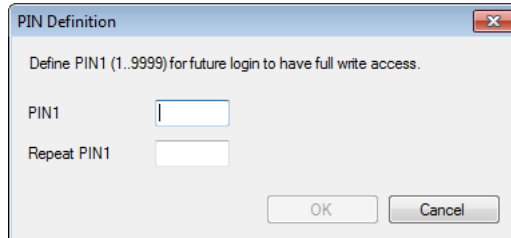

3. Enter the desired PIN(s) and confirm with **OK**.

After successful execution, the write access protection is immediately effective and is displayed in the »EASY Starter« status bar.

4. For a permanent acceptance of the configuration: Save parameter settings in the device.

How to change already defined PIN(s):

1. Remove the active write access protection temporarily (see above).
2. Select the "Full write access" configuration in the "Access protection" parameterisation dialog.
3. Select again the desired configuration of the write access protection.
4. Enter new PIN(s) and confirm with **OK**.
5. Save parameter settings in the device.

How to remove a configured write access protection permanently:

1. Remove the active write access protection temporarily (see above).
2. Select the "Full write access" configuration in the "Access protection" parameterisation dialog.
3. Save parameter settings in the device.

Additional functions

Access protection
Write access protection



Impact of the write access protection on EASY Starter« functions

The following »EASY Starter« functions are not supported when write access protection is active:

- Parameter set download
- Definition of the "Favorites" parameters.
- Definition of the parameters for the "Parameter change-over" function

The following »EASY Starter« functions are supported irrespective of whether write access protection is active:

- Optical device identification [0x2021:001 \(P230.01\)](#)
- Enable/inhibit inverter [0x2822:001](#)
- Reset parameters to default [0x2022:001 \(P700.01\)](#)
- Save parameter set [0x2022:003 \(P700.03\)](#)
- Load user parameter [0x2022:004 \(P700.04\)](#)
- Load OEM parameter [0x2022:005 \(P700.05\)](#)
- Reset error [0x2631:004 \(P400.04\)](#)



Additional functions

Access protection
Write access protection

10.7.1.2 Write access protection in the keypad

If a write access protection is active for the inverter, the keypad automatically displays a log-in when changing to the parameterisation mode. You can either skip the log-in and thus keep the access protection active or remove it temporarily by entering a valid PIN.

Option 1 - skip log-in and keep access protection active

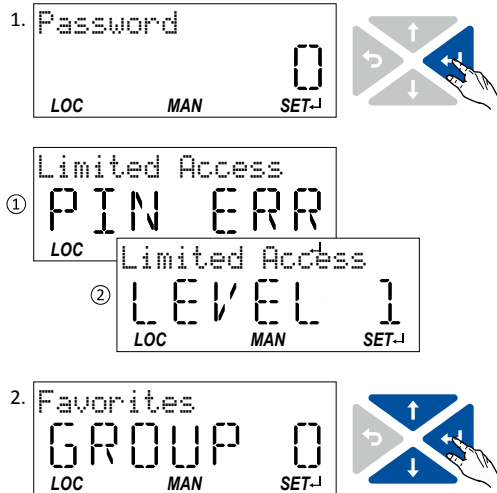

1. Use the key to skip the log-in.

The configured access protection remains active and is briefly displayed:

- ① PIN ERR: No write access
- ② LEVEL 1: Write access only to favorites

You are now in the group level.

2. You can now use the navigation keys and to select the desired group and with key navigate one level lower to the parameter level.

Note: By using the key you can navigate one level upwards again anytime.

Option 2 - remove access protection temporarily by entering a valid PIN

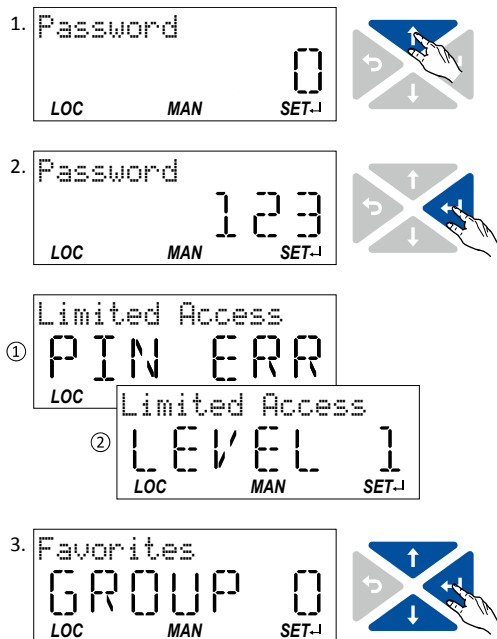

1. Use the key to enter the defined PIN.

2. Use the key to accept the changed setting.

If the access remains restricted, it is briefly displayed:

- ① PIN ERR: No write access
- ② LEVEL 1: Write access only to favorites

You are now in the group level.

3. You can now use the navigation keys and to select the desired group and with key navigate one level lower to the parameter level.

Note: By using the key you can navigate one level upwards again anytime.



After 10 invalid entries, the log-in function is inhibited. In order to remove the log-in inhibit, the inverter must be switched off and on again.

The write access protection gets active again:

- Automatically 10 minutes after the last log-in or the last keypad entry.
- Automatically after the mains voltage is switched on again.

Additional functions

Access protection
Write access protection

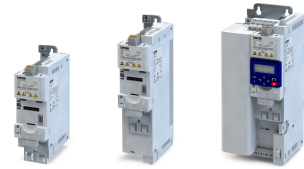

Configuring the write access protection with the keypad

The write access protection is activated by defining PIN1 in P730.00 and/or PIN2 in P731.00 (depending on the desired configuration of the write access protection).

In the following example, the write access protection is configured in such a way that a write access to the favorites only is possible or (when knowing PIN) to all parameters. This configuration only requires the definition of PIN1 (here: "123").

1. VEL:FLEX:AIN1
STOP
REM AUTO SET-1
2. Favorites
GROUP 0
REM AUTO SET-1
3. Addit. functions
GROUP 7
REM AUTO SET-1
4. Device commands
P700.XX
REM AUTO SET-1
5. Protection PIN1
P73000
REM AUTO SET-1
6. P730.00
0
REM AUTO SET-1
7. P730.00
123
REM AUTO SET-1

Defining PIN1:



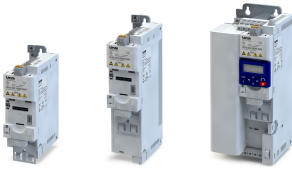







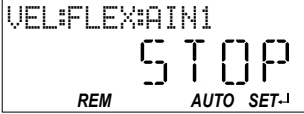
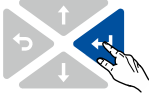

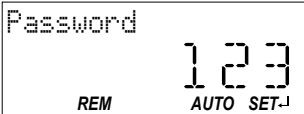



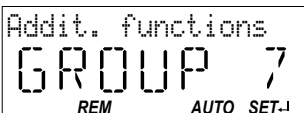



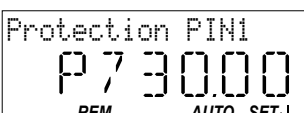

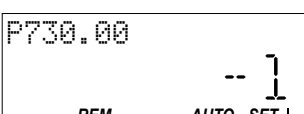
1. Use the key in the operating mode to navigate to the parameterisation mode one level below.
You are now in the group level.
Note: By using the key you can navigate one level upwards again anytime.
2. Use the navigation key to select group 7.
3. Use the key to navigate to one level below.
You are now in the parameter level of the group selected.
4. Use the navigation key to select the P730.00 parameter.
5. Use the key to navigate to one level below.
You are now in the editing mode.
6. Use the navigation key to set PIN1 to the value "123".
7. Use the key to accept the changed setting.
The editing mode is exited.
Note: The configured access protection only gets effective after the parameter group is quit.

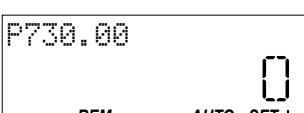

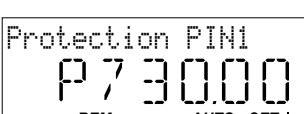

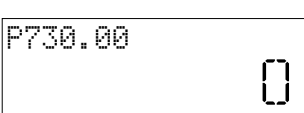

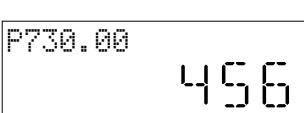







Additional functions

Access protection
Write access protection

In the following example, PIN1 is changed from "123" to "456". For this purpose, the defined PIN must first be deleted by the setting "0".

1.  
2.  
3.  
4.  
5.  
6.  
7.  
8.  
9.  
10.  
11.  
12.  

Change defined PIN1:

1. Use the  key in the operating mode to navigate to the parameterisation mode one level below. Since the access protection is active, the input dialog for the PIN is displayed.
 2. Use the  navigation key to set PIN "123" to remove the access protection temporarily.
 3. Use the  key to accept the entered PIN. You are now in the group level.
 4. Use the  to select group 7.
 5. Use the  key to navigate to one level below. You are now in the parameter level of the group selected.
 6. Use the  to select the P730.00 parameter.
 7. Use the  key to navigate to one level below. You are now in the editing mode.
 8. Use the  key to set PIN1 to the value "0". This setting first deletes PIN1.
 9. Use the  key to accept the changed setting. The editing mode is exited.
 10. Use the  key to navigate again one level below to the editing mode.
 11. Use the  navigation key to set the previously deleted PIN1 to the new value "456".
 12. Use the  key to accept the changed setting. The editing mode is exited.
- Note: The configured access protection only gets effective after the parameter group is quit.

Additional functions

Access protection

Write access protection



How to remove a configured write access protection permanently:

1. Remove the active write access protection temporarily (see above).
2. Set PIN1 (P730.00) and PIN2 (P731.00) to the value "0" (see instructions for changing the PIN).

Impact of the write access protection to the keypad functions

The following keypad functions are supported irrespective of the active write access protection:

- Optical device identification [0x2021:001 \(P230.01\)](#)
- Reset parameters to default [0x2022:001 \(P700.01\)](#)
- Load user parameter [0x2022:004 \(P700.04\)](#)
- Load OEM parameter [0x2022:005 \(P700.05\)](#)











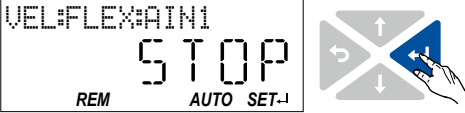
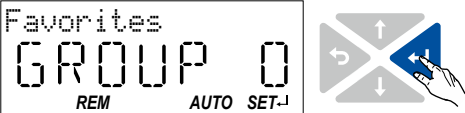
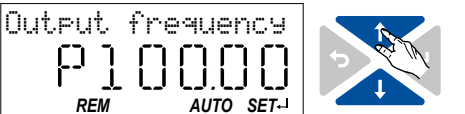
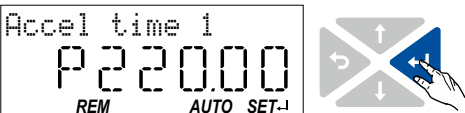

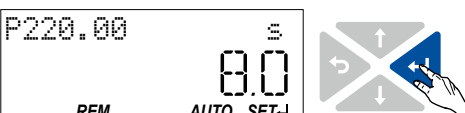

10.8 Favorites

In order to gain quick access using »EASY Starter« or the keypad, frequently used parameters of the inverter can be defined as "Favorites".

- »EASY Starter« provides quick access to the "Favorites" via the *Favorites* tab.
- On the keypad, the "Favorites" can be found in group 0.

10.8.1 Accessing the "Favorites" with the keypad

- 
- 
- 
- 
- 
- 

1. Use the  key in the operating mode to navigate to the parameterisation mode one level below.
You are now in the group level. All parameters of the inverter are divided into different groups according to their function.
Group 0 contains the "Favorites".
Note: By using the  key you can navigate one level upwards again anytime.
2. Use the  key to navigate to one level below.
You are now in the parameter level of the group selected.
3. Use the  and  navigation keys to select the desired parameter.
4. Use the  key to navigate to one level below.
You are now in the editing mode.
5. Set the desired value using the  and  navigation keys.
6. Use the  key to accept the changed setting.
The editing mode is exited.
Note: By using the  key you can exit the editing mode without accepting the new setting (abort).

Additional functions

Favorites

Favorites parameter list (default setting)



10.8.2 Favorites parameter list (default setting)

In the default setting, the most common parameters for the solution of typical applications are defined as "Favorites":

No.	Display code	Name	Default setting	Setting range	Info
1	P100.00	Output frequency	x.x Hz	- (Read only)	0x2DDD (P100.00)
2	P103.00	Current actual	x.x %	- (Read only)	0x6078 (P103.00)
3	P106.00	Motor voltage	x VAC	- (Read only)	0x2D89 (P106.00)
4	P150.00	Error code	-	- (Read only)	0x603F (P150.00)
5	P200.00	Control select.	0	0 ... 1	0x2824 (P200.00)
6	P201.01	Freq. setp. src.	2	0 ... 255	0x2860:001 (P201.01)
7	P203.01	Start method	0	0 ... 255	0x2838:001 (P203.01)
8	P203.03	Stop method	1	0 ... 255	0x2838:003 (P203.03)
9	P208.01	Mains voltage	0	0 ... 255	0x2540:001 (P208.01)
10	P210.00	Min. frequency	0.0 Hz	0.0 ... 599.0 Hz	0x2915 (P210.00)
11	P211.00	Max. frequency	50.0 Hz* 60.0 Hz**	0.0 ... 599.0 Hz	0x2916 (P211.00)
12	P220.00	Accelerat.time 1	5.0 s	0.0 ... 3600.0 s	0x2917 (P220.00)
13	P221.00	Decelerat.time 1	5.0 s	0.0 ... 3600.0 s	0x2918 (P221.00)
14	P300.00	Motor ctrl mode	6	1 ... 7	0x2C00 (P300.00)
15	P302.00	V/f charac.shape	0	0 ... 3	0x2B00 (P302.00)
16	P303.01	Base voltage	230 V	0 ... 5000 V	0x2B01:001 (P303.01)
17	P303.02	Base frequency	50 Hz* 60 Hz**	0 ... 1500 Hz	0x2B01:002 (P303.02)
18	P304.00	Limit. rotation	1	0 ... 255	0x283A (P304.00)
19	P305.00	Switching freq.	0	1 ... 33	0x2939 (P305.00)
20	P308.01	Max.load.for 60s	150 %	30 ... 200 %	0x2D4B:001 (P308.01)
21	P316.01	Fixed V/f boost	2.5 %	0.0 ... 20.0 %	0x2B12:001 (P316.01)
22	P324.00	Max current	200.0 %	0.0 ... 3000.0 %	0x6073 (P324.00)
23	P400.01	Enable inverter	1	0 ... 255	0x2631:001 (P400.01)
24	P400.02	Run	Digital input 1 [11]	Selection list	0x2631:002 (P400.02)
25	P400.03	Quick stop	Not connected [0]	Selection list	0x2631:003 (P400.03)
26	P400.04	Reset fault	Digital input 2 [12]	Selection list	0x2631:004 (P400.04)
27	P400.05	DC braking	Not connected [0]	Selection list	0x2631:005 (P400.05)
28	P400.06	Start forward	Not connected [0]	Selection list	0x2631:006 (P400.06)
29	P400.07	Start reverse	Not connected [0]	Selection list	0x2631:007 (P400.07)
30	P400.08	Run forward	Not connected [0]	Selection list	0x2631:008 (P400.08)
31	P400.09	Run reverse	Not connected [0]	Selection list	0x2631:009 (P400.09)
32	P400.13	Invert rotation	Digital input 3 [13]	Selection list	0x2631:013 (P400.13)
33	P400.18	Setp. Preset b0	Digital input 4 [14]	Selection list	0x2631:018 (P400.18)
34	P400.19	Setp. Preset b1	Digital input 5 [15]	Selection list	0x2631:019 (P400.19)
35	P400.20	Setp. Preset b2	Not connected [0]	Selection list	0x2631:020 (P400.20)
36	P420.01	Relay function	51	0 ... 255	0x2634:001 (P420.01)
37	P420.02	DO1 function	Release brake [115]	Selection list	0x2634:002 (P420.02)
38	P430.01	AI1 input range	0	0 ... 255	0x2636:001 (P430.01)
39	P430.02	AI1 freq @ min	0.0 Hz	-1000.0 ... 1000.0 Hz	0x2636:002 (P430.02)
40	P430.03	AI1 freq @ max	50.0 Hz* 60.0 Hz**	-1000.0 ... 1000.0 Hz	0x2636:003 (P430.03)
41	P440.01	AO1 outp. range	1	0 ... 5	0x2639:001 (P440.01)
42	P440.02	AO1 function	1	0 ... 255	0x2639:002 (P440.02)
43	P440.03	AO1 min. signal	0	-2147483648 ... 2147483647	0x2639:003 (P440.03)
44	P440.04	AO1 max. signal	1000	-2147483648 ... 2147483647	0x2639:004 (P440.04)
45	P450.01	Freq. preset 1	20.0 Hz	0.0 ... 599.0 Hz	0x2911:001 (P450.01)
46	P450.02	Freq. preset 2	40.0 Hz	0.0 ... 599.0 Hz	0x2911:002 (P450.02)
47	P450.03	Freq. preset 3	50.0 Hz* 60.0 Hz**	0.0 ... 599.0 Hz	0x2911:003 (P450.03)
48	P450.04	Freq. preset 4	0.0 Hz	0.0 ... 599.0 Hz	0x2911:004 (P450.04)
49	-	-	-	-	not assigned
50	-	-	-	-	not assigned

* Device for 50-Hz mains ** Device for 60-Hz mains

Firmware version 04.00.00.00

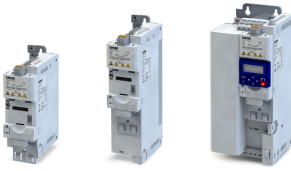

10.8.3 Configuring the "Favorites"

The "Favorites" can be configured by the user.

Details

A maximum number of 50 parameters can be defined as "Favorites".

The easiest way to process the selection of the favorites is via the parameterisation dialog in the »EASY Starter«:

1. Change to the "Parameter list" tab.
2. Select group 0 - Favorites.
3. Click the  button.
4. Process favorites:

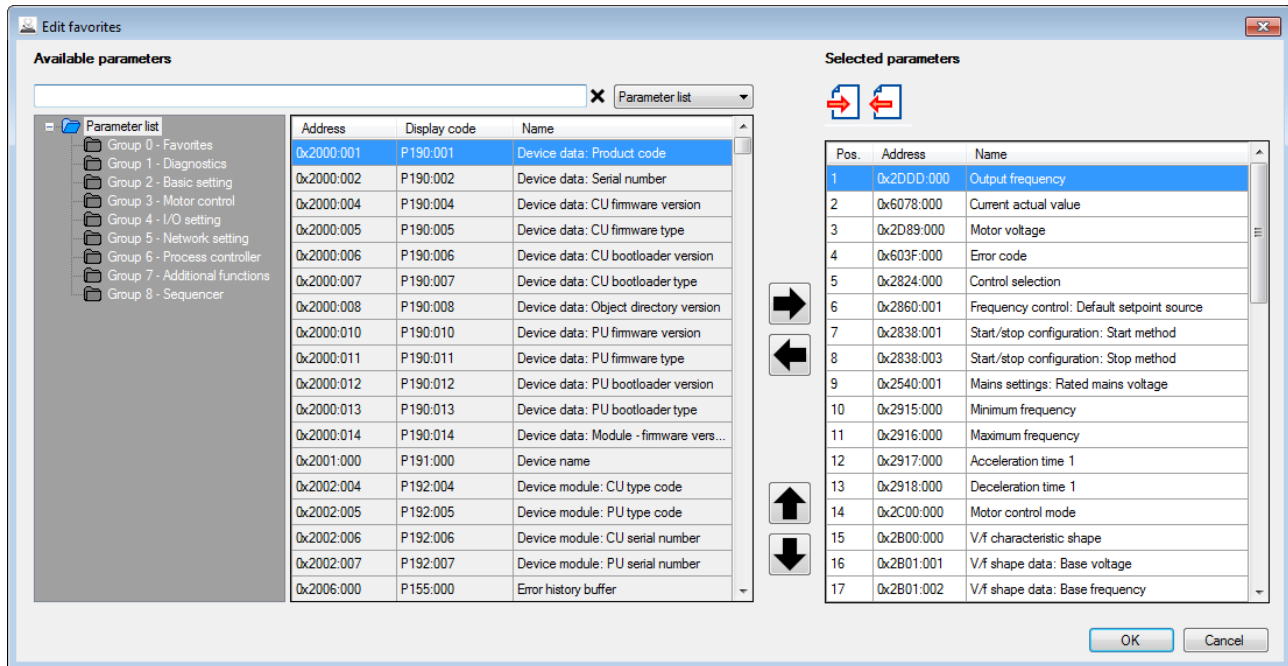

Default favorites can be changed with the keypad or via network via the following parameters:

Parameter	Name / value range / [default setting]	Info
0x261C:001 (P740.01)	Favorites settings: Parameter 1 (Favorites sett.: Parameter 1) 0x00000000 ... [0x2DD00000] ... 0xFFFFFFFF00	Definition of the "Favorites" parameters. <ul style="list-style-type: none"> • Format: 0xiiii:ss00 (iiii = hexadecimal index, ss = hexadecimal subindex) • The lowest byte is always 0x00. • The keypad can be used to select the desired parameter from a list.
0x261C:002 (P740.02)	Favorites settings: Parameter 2 (Favorites sett.: Parameter 2) 0x00000000 ... [0x60780000] ... 0xFFFFFFFF00	
0x261C:003 (P740.03)	Favorites settings: Parameter 3 (Favorites sett.: Parameter 3) 0x00000000 ... [0x2D890000] ... 0xFFFFFFFF00	
0x261C:004 (P740.04)	Favorites settings: Parameter 4 (Favorites sett.: Parameter 4) 0x00000000 ... [0x603F0000] ... 0xFFFFFFFF00	
0x261C:005 (P740.05)	Favorites settings: Parameter 5 (Favorites sett.: Parameter 5) 0x00000000 ... [0x28240000] ... 0xFFFFFFFF00	
0x261C:006 (P740.06)	Favorites settings: Parameter 6 (Favorites sett.: Parameter 6) 0x00000000 ... [0x28600100] ... 0xFFFFFFFF00	
0x261C:007 (P740.07)	Favorites settings: Parameter 7 (Favorites sett.: Parameter 7) 0x00000000 ... [0x28380100] ... 0xFFFFFFFF00	
0x261C:008 (P740.08)	Favorites settings: Parameter 8 (Favorites sett.: Parameter 8) 0x00000000 ... [0x28380300] ... 0xFFFFFFFF00	

Additional functions

Favorites Configuring the "Favorites"

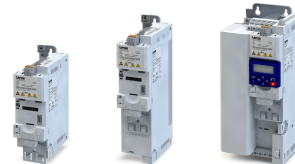

Parameter	Name / value range / [default setting]	Info
0x261C:009 (P740.09)	Favorites settings: Parameter 9 (Favorites sett.: Parameter 9) 0x00000000 ... [0x25400100] ... 0xFFFFFFFF00	
0x261C:010 (P740.10)	Favorites settings: Parameter 10 (Favorites sett.: Parameter 10) 0x00000000 ... [0x29150000] ... 0xFFFFFFFF00	
0x261C:011 (P740.11)	Favorites settings: Parameter 11 (Favorites sett.: Parameter 11) 0x00000000 ... [0x29160000] ... 0xFFFFFFFF00	
0x261C:012 (P740.12)	Favorites settings: Parameter 12 (Favorites sett.: Parameter 12) 0x00000000 ... [0x29170000] ... 0xFFFFFFFF00	
0x261C:013 (P740.13)	Favorites settings: Parameter 13 (Favorites sett.: Parameter 13) 0x00000000 ... [0x29180000] ... 0xFFFFFFFF00	
0x261C:014 (P740.14)	Favorites settings: Parameter 14 (Favorites sett.: Parameter 14) 0x00000000 ... [0x2C000000] ... 0xFFFFFFFF00	
0x261C:015 (P740.15)	Favorites settings: Parameter 15 (Favorites sett.: Parameter 15) 0x00000000 ... [0x2B000000] ... 0xFFFFFFFF00	
0x261C:016 (P740.16)	Favorites settings: Parameter 16 (Favorites sett.: Parameter 16) 0x00000000 ... [0x2B010100] ... 0xFFFFFFFF00	
0x261C:017 (P740.17)	Favorites settings: Parameter 17 (Favorites sett.: Parameter 17) 0x00000000 ... [0x2B010200] ... 0xFFFFFFFF00	
0x261C:018 (P740.18)	Favorites settings: Parameter 18 (Favorites sett.: Parameter 18) 0x00000000 ... [0x283A0000] ... 0xFFFFFFFF00	
0x261C:019 (P740.19)	Favorites settings: Parameter 19 (Favorites sett.: Parameter 19) 0x00000000 ... [0x29390000] ... 0xFFFFFFFF00	
0x261C:020 (P740.20)	Favorites settings: Parameter 20 (Favorites sett.: Parameter 20) 0x00000000 ... [0x2D4B0100] ... 0xFFFFFFFF00	
0x261C:021 (P740.21)	Favorites settings: Parameter 21 (Favorites sett.: Parameter 21) 0x00000000 ... [0x2B120100] ... 0xFFFFFFFF00	
0x261C:022 (P740.22)	Favorites settings: Parameter 22 (Favorites sett.: Parameter 22) 0x00000000 ... [0x60730000] ... 0xFFFFFFFF00	
0x261C:023 (P740.23)	Favorites settings: Parameter 23 (Favorites sett.: Parameter 23) 0x00000000 ... [0x26310100] ... 0xFFFFFFFF00	
0x261C:024 (P740.24)	Favorites settings: Parameter 24 (Favorites sett.: Parameter 24) 0x00000000 ... [0x26310200] ... 0xFFFFFFFF00	
0x261C:025 (P740.25)	Favorites settings: Parameter 25 (Favorites sett.: Parameter 25) 0x00000000 ... [0x26310300] ... 0xFFFFFFFF00	
0x261C:026 (P740.26)	Favorites settings: Parameter 26 (Favorites sett.: Parameter 26) 0x00000000 ... [0x26310400] ... 0xFFFFFFFF00	
0x261C:027 (P740.27)	Favorites settings: Parameter 27 (Favorites sett.: Parameter 27) 0x00000000 ... [0x26310500] ... 0xFFFFFFFF00	
0x261C:028 (P740.28)	Favorites settings: Parameter 28 (Favorites sett.: Parameter 28) 0x00000000 ... [0x26310600] ... 0xFFFFFFFF00	
0x261C:029 (P740.29)	Favorites settings: Parameter 29 (Favorites sett.: Parameter 29) 0x00000000 ... [0x26310700] ... 0xFFFFFFFF00	



Additional functions

Favorites
Configuring the "Favorites"

Parameter	Name / value range / [default setting]	Info
0x261C:030 (P740.30)	Favorites settings: Parameter 30 (Favorites sett.: Parameter 30) 0x00000000 ... [0x26310800] ... 0xFFFFFFFF00	
0x261C:031 (P740.31)	Favorites settings: Parameter 31 (Favorites sett.: Parameter 31) 0x00000000 ... [0x26310900] ... 0xFFFFFFFF00	
0x261C:032 (P740.32)	Favorites settings: Parameter 32 (Favorites sett.: Parameter 32) 0x00000000 ... [0x26310D00] ... 0xFFFFFFFF00	
0x261C:033 (P740.33)	Favorites settings: Parameter 33 (Favorites sett.: Parameter 33) 0x00000000 ... [0x26311200] ... 0xFFFFFFFF00	
0x261C:034 (P740.34)	Favorites settings: Parameter 34 (Favorites sett.: Parameter 34) 0x00000000 ... [0x26311300] ... 0xFFFFFFFF00	
0x261C:035 (P740.35)	Favorites settings: Parameter 35 (Favorites sett.: Parameter 35) 0x00000000 ... [0x26311400] ... 0xFFFFFFFF00	
0x261C:036 (P740.36)	Favorites settings: Parameter 36 (Favorites sett.: Parameter 36) 0x00000000 ... [0x26340100] ... 0xFFFFFFFF00	
0x261C:037 (P740.37)	Favorites settings: Parameter 37 (Favorites sett.: Parameter 37) 0x00000000 ... [0x26340200] ... 0xFFFFFFFF00	
0x261C:038 (P740.38)	Favorites settings: Parameter 38 (Favorites sett.: Parameter 38) 0x00000000 ... [0x26360100] ... 0xFFFFFFFF00	
0x261C:039 (P740.39)	Favorites settings: Parameter 39 (Favorites sett.: Parameter 39) 0x00000000 ... [0x26360200] ... 0xFFFFFFFF00	
0x261C:040 (P740.40)	Favorites settings: Parameter 40 (Favorites sett.: Parameter 40) 0x00000000 ... [0x26360300] ... 0xFFFFFFFF00	
0x261C:041 (P740.41)	Favorites settings: Parameter 41 (Favorites sett.: Parameter 41) 0x00000000 ... [0x26390100] ... 0xFFFFFFFF00	
0x261C:042 (P740.42)	Favorites settings: Parameter 42 (Favorites sett.: Parameter 42) 0x00000000 ... [0x26390200] ... 0xFFFFFFFF00	
0x261C:043 (P740.43)	Favorites settings: Parameter 43 (Favorites sett.: Parameter 43) 0x00000000 ... [0x26390300] ... 0xFFFFFFFF00	
0x261C:044 (P740.44)	Favorites settings: Parameter 44 (Favorites sett.: Parameter 44) 0x00000000 ... [0x26390400] ... 0xFFFFFFFF00	
0x261C:045 (P740.45)	Favorites settings: Parameter 45 (Favorites sett.: Parameter 45) 0x00000000 ... [0x29110100] ... 0xFFFFFFFF00	
0x261C:046 (P740.46)	Favorites settings: Parameter 46 (Favorites sett.: Parameter 46) 0x00000000 ... [0x29110200] ... 0xFFFFFFFF00	
0x261C:047 (P740.47)	Favorites settings: Parameter 47 (Favorites sett.: Parameter 47) 0x00000000 ... [0x29110300] ... 0xFFFFFFFF00	
0x261C:048 (P740.48)	Favorites settings: Parameter 48 (Favorites sett.: Parameter 48) 0x00000000 ... [0x29110400] ... 0xFFFFFFFF00	
0x261C:049 (P740.49)	Favorites settings: Parameter 49 (Favorites sett.: Parameter 49) 0x00000000 ... [0x00000000] ... 0xFFFFFFFF00	
0x261C:050 (P740.50)	Favorites settings: Parameter 50 (Favorites sett.: Parameter 50) 0x00000000 ... [0x00000000] ... 0xFFFFFFFF00	

Additional functions

Parameter change-over
Configuring the "Favorites"



10.9 Parameter change-over

For up to 32 freely selectable parameters, this function provides a change-over between four sets with different parameter values.

⚠ DANGER!

Changed parameter settings are effective immediately.

The possible consequence is an unexpected response of the motor shaft while the inverter is enabled.

- ▶ If possible, only carry out parameter changes while the inverter is disabled.
- ▶ Certain device commands or settings which might cause a critical state of the drive behaviour can generally only be carried out when the inverter is inhibited.

Details

The parameter list is compiled in the same way as that of the "Favorites" via configuration. »EASY Starter« provides a user-friendly parameterisation dialog for this purpose.

Change-over to another value set can optionally be effected via corresponding device commands and/or special functions/triggers:

- ▶ [Device commands for parameter change-over](#) 369
- ▶ [Functions for parameter change-over](#) 550

Parameter	Name / value range / [default setting]	Info
0x2022:011 (P700.11)	Device commands: Save parameter set 1 (Device commands: Save par. set 1) • For further possible settings, see parameter 0x2022:001 (P700.01) . 366	1 = save value set 1 of the "Parameter change-over" function. • When the device command has been executed successfully, the value 0 is shown.
	0 Off / ready	Only status feedback
0x2022:012 (P700.12)	Device commands: Save parameter set 2 (Device commands: Save par. set 2) • For further possible settings, see parameter 0x2022:001 (P700.01) . 366	1 = save value set 2 of the "Parameter change-over" function. • When the device command has been executed successfully, the value 0 is shown.
	0 Off / ready	Only status feedback
0x2022:013 (P700.13)	Device commands: Save parameter set 3 (Device commands: Save par. set 3) • For further possible settings, see parameter 0x2022:001 (P700.01) . 366	1 = save value set 3 of the "Parameter change-over" function. • When the device command has been executed successfully, the value 0 is shown.
	0 Off / ready	Only status feedback
0x2022:014 (P700.14)	Device commands: Save parameter set 4 (Device commands: Save par. set 4) • For further possible settings, see parameter 0x2022:001 (P700.01) . 366	1 = save value set 3 of the "Parameter change-over" function. • When the device command has been executed successfully, the value 0 is shown.
	0 Off / ready	Only status feedback



Additional functions

Parameter change-over Configuring the "Favorites"

Parameter	Name / value range / [default setting]	Info
0x4041:001 (P750.01)	Parameter change-over: Parameter 1 (Param.set setup: Parameter 1) 0x00000000 ... [0x00000000] ... 0xFFFFFFFF00	Definition of the parameter list for the "Parameter change-over" function. <ul style="list-style-type: none"> • Format: 0xiiiiSS00 (iiii = hexadecimal index, ss = hexadecimal subindex) • The lowest byte is always 0x00.
0x4041:002 (P750.02)	Parameter change-over: Parameter 2 (Param.set setup: Parameter 2) 0x00000000 ... [0x00000000] ... 0xFFFFFFFF00	
0x4041:003 (P750.03)	Parameter change-over: Parameter 3 (Param.set setup: Parameter 3) 0x00000000 ... [0x00000000] ... 0xFFFFFFFF00	
0x4041:004 (P750.04)	Parameter change-over: Parameter 4 (Param.set setup: Parameter 4) 0x00000000 ... [0x00000000] ... 0xFFFFFFFF00	
0x4041:005 (P750.05)	Parameter change-over: Parameter 5 (Param.set setup: Parameter 5) 0x00000000 ... [0x00000000] ... 0xFFFFFFFF00	
0x4041:006 (P750.06)	Parameter change-over: Parameter 6 (Param.set setup: Parameter 6) 0x00000000 ... [0x00000000] ... 0xFFFFFFFF00	
0x4041:007 (P750.07)	Parameter change-over: Parameter 7 (Param.set setup: Parameter 7) 0x00000000 ... [0x00000000] ... 0xFFFFFFFF00	
0x4041:008 (P750.08)	Parameter change-over: Parameter 8 (Param.set setup: Parameter 8) 0x00000000 ... [0x00000000] ... 0xFFFFFFFF00	
0x4041:009 (P750.09)	Parameter change-over: Parameter 9 (Param.set setup: Parameter 9) 0x00000000 ... [0x00000000] ... 0xFFFFFFFF00	
0x4041:010 (P750.10)	Parameter change-over: Parameter 10 (Param.set setup: Parameter 10) 0x00000000 ... [0x00000000] ... 0xFFFFFFFF00	
0x4041:011 (P750.11)	Parameter change-over: Parameter 11 (Param.set setup: Parameter 11) 0x00000000 ... [0x00000000] ... 0xFFFFFFFF00	
0x4041:012 (P750.12)	Parameter change-over: Parameter 12 (Param.set setup: Parameter 12) 0x00000000 ... [0x00000000] ... 0xFFFFFFFF00	
0x4041:013 (P750.13)	Parameter change-over: Parameter 13 (Param.set setup: Parameter 13) 0x00000000 ... [0x00000000] ... 0xFFFFFFFF00	
0x4041:014 (P750.14)	Parameter change-over: Parameter 14 (Param.set setup: Parameter 14) 0x00000000 ... [0x00000000] ... 0xFFFFFFFF00	
0x4041:015 (P750.15)	Parameter change-over: Parameter 15 (Param.set setup: Parameter 15) 0x00000000 ... [0x00000000] ... 0xFFFFFFFF00	
0x4041:016 (P750.16)	Parameter change-over: Parameter 16 (Param.set setup: Parameter 16) 0x00000000 ... [0x00000000] ... 0xFFFFFFFF00	
0x4041:017 (P750.17)	Parameter change-over: Parameter 17 (Param.set setup: Parameter 17) 0x00000000 ... [0x00000000] ... 0xFFFFFFFF00	
0x4041:018 (P750.18)	Parameter change-over: Parameter 18 (Param.set setup: Parameter 18) 0x00000000 ... [0x00000000] ... 0xFFFFFFFF00	
0x4041:019 (P750.19)	Parameter change-over: Parameter 19 (Param.set setup: Parameter 19) 0x00000000 ... [0x00000000] ... 0xFFFFFFFF00	
0x4041:020 (P750.20)	Parameter change-over: Parameter 20 (Param.set setup: Parameter 20) 0x00000000 ... [0x00000000] ... 0xFFFFFFFF00	
0x4041:021 (P750.21)	Parameter change-over: Parameter 21 (Param.set setup: Parameter 21) 0x00000000 ... [0x00000000] ... 0xFFFFFFFF00	

Additional functions

Parameter change-over
Configuring the "Favorites"



Parameter	Name / value range / [default setting]	Info
0x4041:022 (P750.22)	Parameter change-over: Parameter 22 (Param.set setup: Parameter 22) 0x00000000 ... [0x00000000] ... 0xFFFFFFFF00	
0x4041:023 (P750.23)	Parameter change-over: Parameter 23 (Param.set setup: Parameter 23) 0x00000000 ... [0x00000000] ... 0xFFFFFFFF00	
0x4041:024 (P750.24)	Parameter change-over: Parameter 24 (Param.set setup: Parameter 24) 0x00000000 ... [0x00000000] ... 0xFFFFFFFF00	
0x4041:025 (P750.25)	Parameter change-over: Parameter 25 (Param.set setup: Parameter 25) 0x00000000 ... [0x00000000] ... 0xFFFFFFFF00	
0x4041:026 (P750.26)	Parameter change-over: Parameter 26 (Param.set setup: Parameter 26) 0x00000000 ... [0x00000000] ... 0xFFFFFFFF00	
0x4041:027 (P750.27)	Parameter change-over: Parameter 27 (Param.set setup: Parameter 27) 0x00000000 ... [0x00000000] ... 0xFFFFFFFF00	
0x4041:028 (P750.28)	Parameter change-over: Parameter 28 (Param.set setup: Parameter 28) 0x00000000 ... [0x00000000] ... 0xFFFFFFFF00	
0x4041:029 (P750.29)	Parameter change-over: Parameter 29 (Param.set setup: Parameter 29) 0x00000000 ... [0x00000000] ... 0xFFFFFFFF00	
0x4041:030 (P750.30)	Parameter change-over: Parameter 30 (Param.set setup: Parameter 30) 0x00000000 ... [0x00000000] ... 0xFFFFFFFF00	
0x4041:031 (P750.31)	Parameter change-over: Parameter 31 (Param.set setup: Parameter 31) 0x00000000 ... [0x00000000] ... 0xFFFFFFFF00	
0x4041:032 (P750.32)	Parameter change-over: Parameter 32 (Param.set setup: Parameter 32) 0x00000000 ... [0x00000000] ... 0xFFFFFFFF00	

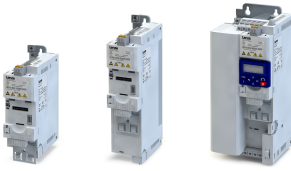

Additional functions

Parameter change-over
Configuring the "Favorites"

Parameter	Name / value range / [default setting]	Info
0x4042:001 (P751.01)	Parameter value set 1: Value of parameter 1 (Par. value set 1: Set 1 - Value 1) -2147483648 ... [0] ... 2147483647	Value set 1 for the parameter list defined in 0x4041:001 (P750.01).
0x4042:002 (P751.02)	Parameter value set 1: Value of parameter 2 (Par. value set 1: Set 1 - Value 2) -2147483648 ... [0] ... 2147483647	
0x4042:003 (P751.03)	Parameter value set 1: Value of parameter 3 (Par. value set 1: Set 1 - Value 3) -2147483648 ... [0] ... 2147483647	
0x4042:004 (P751.04)	Parameter value set 1: Value of parameter 4 (Par. value set 1: Set 1 - Value 4) -2147483648 ... [0] ... 2147483647	
0x4042:005 (P751.05)	Parameter value set 1: Value of parameter 5 (Par. value set 1: Set 1 - Value 5) -2147483648 ... [0] ... 2147483647	
0x4042:006 (P751.06)	Parameter value set 1: Value of parameter 6 (Par. value set 1: Set 1 - Value 6) -2147483648 ... [0] ... 2147483647	
0x4042:007 (P751.07)	Parameter value set 1: Value of parameter 7 (Par. value set 1: Set 1 - Value 7) -2147483648 ... [0] ... 2147483647	
0x4042:008 (P751.08)	Parameter value set 1: Value of parameter 8 (Par. value set 1: Set 1 - Value 8) -2147483648 ... [0] ... 2147483647	
0x4042:009 (P751.09)	Parameter value set 1: Value of parameter 9 (Par. value set 1: Set 1 - Value 9) -2147483648 ... [0] ... 2147483647	
0x4042:010 (P751.10)	Parameter value set 1: Value of parameter 10 (Par. value set 1: Set 1 - Value 10) -2147483648 ... [0] ... 2147483647	
0x4042:011 (P751.11)	Parameter value set 1: Value of parameter 11 (Par. value set 1: Set 1 - Value 11) -2147483648 ... [0] ... 2147483647	
0x4042:012 (P751.12)	Parameter value set 1: Value of parameter 12 (Par. value set 1: Set 1 - Value 12) -2147483648 ... [0] ... 2147483647	
0x4042:013 (P751.13)	Parameter value set 1: Value of parameter 13 (Par. value set 1: Set 1 - Value 13) -2147483648 ... [0] ... 2147483647	
0x4042:014 (P751.14)	Parameter value set 1: Value of parameter 14 (Par. value set 1: Set 1 - Value 14) -2147483648 ... [0] ... 2147483647	
0x4042:015 (P751.15)	Parameter value set 1: Value of parameter 15 (Par. value set 1: Set 1 - Value 15) -2147483648 ... [0] ... 2147483647	
0x4042:016 (P751.16)	Parameter value set 1: Value of parameter 16 (Par. value set 1: Set 1 - Value 16) -2147483648 ... [0] ... 2147483647	
0x4042:017 (P751.17)	Parameter value set 1: Value of parameter 17 (Par. value set 1: Set 1 - Value 17) -2147483648 ... [0] ... 2147483647	
0x4042:018 (P751.18)	Parameter value set 1: Value of parameter 18 (Par. value set 1: Set 1 - Value 18) -2147483648 ... [0] ... 2147483647	
0x4042:019 (P751.19)	Parameter value set 1: Value of parameter 19 (Par. value set 1: Set 1 - Value 19) -2147483648 ... [0] ... 2147483647	
0x4042:020 (P751.20)	Parameter value set 1: Value of parameter 20 (Par. value set 1: Set 1 - Value 20) -2147483648 ... [0] ... 2147483647	
0x4042:021 (P751.21)	Parameter value set 1: Value of parameter 21 (Par. value set 1: Set 1 - Value 21) -2147483648 ... [0] ... 2147483647	

Additional functions

Parameter change-over
Configuring the "Favorites"

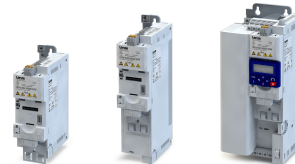

Parameter	Name / value range / [default setting]	Info
0x4042:022 (P751.22)	Parameter value set 1: Value of parameter 22 (Par. value set 1: Set 1 - Value 22) -2147483648 ... [0] ... 2147483647	
0x4042:023 (P751.23)	Parameter value set 1: Value of parameter 23 (Par. value set 1: Set 1 - Value 23) -2147483648 ... [0] ... 2147483647	
0x4042:024 (P751.24)	Parameter value set 1: Value of parameter 24 (Par. value set 1: Set 1 - Value 24) -2147483648 ... [0] ... 2147483647	
0x4042:025 (P751.25)	Parameter value set 1: Value of parameter 25 (Par. value set 1: Set 1 - Value 25) -2147483648 ... [0] ... 2147483647	
0x4042:026 (P751.26)	Parameter value set 1: Value of parameter 26 (Par. value set 1: Set 1 - Value 26) -2147483648 ... [0] ... 2147483647	
0x4042:027 (P751.27)	Parameter value set 1: Value of parameter 27 (Par. value set 1: Set 1 - Value 27) -2147483648 ... [0] ... 2147483647	
0x4042:028 (P751.28)	Parameter value set 1: Value of parameter 28 (Par. value set 1: Set 1 - Value 28) -2147483648 ... [0] ... 2147483647	
0x4042:029 (P751.29)	Parameter value set 1: Value of parameter 29 (Par. value set 1: Set 1 - Value 29) -2147483648 ... [0] ... 2147483647	
0x4042:030 (P751.30)	Parameter value set 1: Value of parameter 30 (Par. value set 1: Set 1 - Value 30) -2147483648 ... [0] ... 2147483647	
0x4042:031 (P751.31)	Parameter value set 1: Value of parameter 31 (Par. value set 1: Set 1 - Value 31) -2147483648 ... [0] ... 2147483647	
0x4042:032 (P751.32)	Parameter value set 1: Value of parameter 32 (Par. value set 1: Set 1 - Value 32) -2147483648 ... [0] ... 2147483647	



Additional functions

Parameter change-over
Configuring the "Favorites"

Parameter	Name / value range / [default setting]	Info
0x4043:001 (P752.01)	Parameter value set 2: Value of parameter 1 (Par. value set 2: Set 2 - Value 1) -2147483648 ... [0] ... 2147483647	Value set 2 for the parameter list defined in 0x4041:001 (P750.01).
0x4043:002 (P752.02)	Parameter value set 2: Value of parameter 2 (Par. value set 2: Set 2 - Value 2) -2147483648 ... [0] ... 2147483647	
0x4043:003 (P752.03)	Parameter value set 2: Value of parameter 3 (Par. value set 2: Set 2 - Value 3) -2147483648 ... [0] ... 2147483647	
0x4043:004 (P752.04)	Parameter value set 2: Value of parameter 4 (Par. value set 2: Set 2 - Value 4) -2147483648 ... [0] ... 2147483647	
0x4043:005 (P752.05)	Parameter value set 2: Value of parameter 5 (Par. value set 2: Set 2 - Value 5) -2147483648 ... [0] ... 2147483647	
0x4043:006 (P752.06)	Parameter value set 2: Value of parameter 6 (Par. value set 2: Set 2 - Value 6) -2147483648 ... [0] ... 2147483647	
0x4043:007 (P752.07)	Parameter value set 2: Value of parameter 7 (Par. value set 2: Set 2 - Value 7) -2147483648 ... [0] ... 2147483647	
0x4043:008 (P752.08)	Parameter value set 2: Value of parameter 8 (Par. value set 2: Set 2 - Value 8) -2147483648 ... [0] ... 2147483647	
0x4043:009 (P752.09)	Parameter value set 2: Value of parameter 9 (Par. value set 2: Set 2 - Value 9) -2147483648 ... [0] ... 2147483647	
0x4043:010 (P752.10)	Parameter value set 2: Value of parameter 10 (Par. value set 2: Set 2 - Value 10) -2147483648 ... [0] ... 2147483647	
0x4043:011 (P752.11)	Parameter value set 2: Value of parameter 11 (Par. value set 2: Set 2 - Value 11) -2147483648 ... [0] ... 2147483647	
0x4043:012 (P752.12)	Parameter value set 2: Value of parameter 12 (Par. value set 2: Set 2 - Value 12) -2147483648 ... [0] ... 2147483647	
0x4043:013 (P752.13)	Parameter value set 2: Value of parameter 13 (Par. value set 2: Set 2 - Value 13) -2147483648 ... [0] ... 2147483647	
0x4043:014 (P752.14)	Parameter value set 2: Value of parameter 14 (Par. value set 2: Set 2 - Value 14) -2147483648 ... [0] ... 2147483647	
0x4043:015 (P752.15)	Parameter value set 2: Value of parameter 15 (Par. value set 2: Set 2 - Value 15) -2147483648 ... [0] ... 2147483647	
0x4043:016 (P752.16)	Parameter value set 2: Value of parameter 16 (Par. value set 2: Set 2 - Value 16) -2147483648 ... [0] ... 2147483647	
0x4043:017 (P752.17)	Parameter value set 2: Value of parameter 17 (Par. value set 2: Set 2 - Value 17) -2147483648 ... [0] ... 2147483647	
0x4043:018 (P752.18)	Parameter value set 2: Value of parameter 18 (Par. value set 2: Set 2 - Value 18) -2147483648 ... [0] ... 2147483647	
0x4043:019 (P752.19)	Parameter value set 2: Value of parameter 19 (Par. value set 2: Set 2 - Value 19) -2147483648 ... [0] ... 2147483647	
0x4043:020 (P752.20)	Parameter value set 2: Value of parameter 20 (Par. value set 2: Set 2 - Value 20) -2147483648 ... [0] ... 2147483647	
0x4043:021 (P752.21)	Parameter value set 2: Value of parameter 21 (Par. value set 2: Set 2 - Value 21) -2147483648 ... [0] ... 2147483647	

Additional functions

Parameter change-over
Configuring the "Favorites"

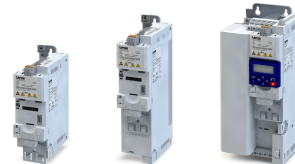

Parameter	Name / value range / [default setting]	Info
0x4043:022 (P752.22)	Parameter value set 2: Value of parameter 22 (Par. value set 2: Set 2 - Value 22) -2147483648 ... [0] ... 2147483647	
0x4043:023 (P752.23)	Parameter value set 2: Value of parameter 23 (Par. value set 2: Set 2 - Value 23) -2147483648 ... [0] ... 2147483647	
0x4043:024 (P752.24)	Parameter value set 2: Value of parameter 24 (Par. value set 2: Set 2 - Value 24) -2147483648 ... [0] ... 2147483647	
0x4043:025 (P752.25)	Parameter value set 2: Value of parameter 25 (Par. value set 2: Set 2 - Value 25) -2147483648 ... [0] ... 2147483647	
0x4043:026 (P752.26)	Parameter value set 2: Value of parameter 26 (Par. value set 2: Set 2 - Value 26) -2147483648 ... [0] ... 2147483647	
0x4043:027 (P752.27)	Parameter value set 2: Value of parameter 27 (Par. value set 2: Set 2 - Value 27) -2147483648 ... [0] ... 2147483647	
0x4043:028 (P752.28)	Parameter value set 2: Value of parameter 28 (Par. value set 2: Set 2 - Value 28) -2147483648 ... [0] ... 2147483647	
0x4043:029 (P752.29)	Parameter value set 2: Value of parameter 29 (Par. value set 2: Set 2 - Value 29) -2147483648 ... [0] ... 2147483647	
0x4043:030 (P752.30)	Parameter value set 2: Value of parameter 30 (Par. value set 2: Set 2 - Value 30) -2147483648 ... [0] ... 2147483647	
0x4043:031 (P752.31)	Parameter value set 2: Value of parameter 31 (Par. value set 2: Set 2 - Value 31) -2147483648 ... [0] ... 2147483647	
0x4043:032 (P752.32)	Parameter value set 2: Value of parameter 32 (Par. value set 2: Set 2 - Value 32) -2147483648 ... [0] ... 2147483647	



Additional functions

Parameter change-over
Configuring the "Favorites"

Parameter	Name / value range / [default setting]	Info
Ox4044:001 (P753.01)	Parameter value set 3: Value of parameter 1 (Par. value set 3: Set 3 - Value 1) -2147483648 ... [0] ... 2147483647	Value set 3 for the parameter list defined in 0x4041:001 (P750.01) .
Ox4044:002 (P753.02)	Parameter value set 3: Value of parameter 2 (Par. value set 3: Set 3 - Value 2) -2147483648 ... [0] ... 2147483647	
Ox4044:003 (P753.03)	Parameter value set 3: Value of parameter 3 (Par. value set 3: Set 3 - Value 3) -2147483648 ... [0] ... 2147483647	
Ox4044:004 (P753.04)	Parameter value set 3: Value of parameter 4 (Par. value set 3: Set 3 - Value 4) -2147483648 ... [0] ... 2147483647	
Ox4044:005 (P753.05)	Parameter value set 3: Value of parameter 5 (Par. value set 3: Set 3 - Value 5) -2147483648 ... [0] ... 2147483647	
Ox4044:006 (P753.06)	Parameter value set 3: Value of parameter 6 (Par. value set 3: Set 3 - Value 6) -2147483648 ... [0] ... 2147483647	
Ox4044:007 (P753.07)	Parameter value set 3: Value of parameter 7 (Par. value set 3: Set 3 - Value 7) -2147483648 ... [0] ... 2147483647	
Ox4044:008 (P753.08)	Parameter value set 3: Value of parameter 8 (Par. value set 3: Set 3 - Value 8) -2147483648 ... [0] ... 2147483647	
Ox4044:009 (P753.09)	Parameter value set 3: Value of parameter 9 (Par. value set 3: Set 3 - Value 9) -2147483648 ... [0] ... 2147483647	
Ox4044:010 (P753.10)	Parameter value set 3: Value of parameter 10 (Par. value set 3: Set 3 - Value 10) -2147483648 ... [0] ... 2147483647	
Ox4044:011 (P753.11)	Parameter value set 3: Value of parameter 11 (Par. value set 3: Set 3 - Value 11) -2147483648 ... [0] ... 2147483647	
Ox4044:012 (P753.12)	Parameter value set 3: Value of parameter 12 (Par. value set 3: Set 3 - Value 12) -2147483648 ... [0] ... 2147483647	
Ox4044:013 (P753.13)	Parameter value set 3: Value of parameter 13 (Par. value set 3: Set 3 - Value 13) -2147483648 ... [0] ... 2147483647	
Ox4044:014 (P753.14)	Parameter value set 3: Value of parameter 14 (Par. value set 3: Set 3 - Value 14) -2147483648 ... [0] ... 2147483647	
Ox4044:015 (P753.15)	Parameter value set 3: Value of parameter 15 (Par. value set 3: Set 3 - Value 15) -2147483648 ... [0] ... 2147483647	
Ox4044:016 (P753.16)	Parameter value set 3: Value of parameter 16 (Par. value set 3: Set 3 - Value 16) -2147483648 ... [0] ... 2147483647	
Ox4044:017 (P753.17)	Parameter value set 3: Value of parameter 17 (Par. value set 3: Set 3 - Value 17) -2147483648 ... [0] ... 2147483647	
Ox4044:018 (P753.18)	Parameter value set 3: Value of parameter 18 (Par. value set 3: Set 3 - Value 18) -2147483648 ... [0] ... 2147483647	
Ox4044:019 (P753.19)	Parameter value set 3: Value of parameter 19 (Par. value set 3: Set 3 - Value 19) -2147483648 ... [0] ... 2147483647	
Ox4044:020 (P753.20)	Parameter value set 3: Value of parameter 20 (Par. value set 3: Set 3 - Value 20) -2147483648 ... [0] ... 2147483647	
Ox4044:021 (P753.21)	Parameter value set 3: Value of parameter 21 (Par. value set 3: Set 3 - Value 21) -2147483648 ... [0] ... 2147483647	

Additional functions

Parameter change-over
Configuring the "Favorites"



Parameter	Name / value range / [default setting]	Info
0x4044:022 (P753.22)	Parameter value set 3: Value of parameter 22 (Par. value set 3: Set 3 - Value 22) -2147483648 ... [0] ... 2147483647	
0x4044:023 (P753.23)	Parameter value set 3: Value of parameter 23 (Par. value set 3: Set 3 - Value 23) -2147483648 ... [0] ... 2147483647	
0x4044:024 (P753.24)	Parameter value set 3: Value of parameter 24 (Par. value set 3: Set 3 - Value 24) -2147483648 ... [0] ... 2147483647	
0x4044:025 (P753.25)	Parameter value set 3: Value of parameter 25 (Par. value set 3: Set 3 - Value 25) -2147483648 ... [0] ... 2147483647	
0x4044:026 (P753.26)	Parameter value set 3: Value of parameter 26 (Par. value set 3: Set 3 - Value 26) -2147483648 ... [0] ... 2147483647	
0x4044:027 (P753.27)	Parameter value set 3: Value of parameter 27 (Par. value set 3: Set 3 - Value 27) -2147483648 ... [0] ... 2147483647	
0x4044:028 (P753.28)	Parameter value set 3: Value of parameter 28 (Par. value set 3: Set 3 - Value 28) -2147483648 ... [0] ... 2147483647	
0x4044:029 (P753.29)	Parameter value set 3: Value of parameter 29 (Par. value set 3: Set 3 - Value 29) -2147483648 ... [0] ... 2147483647	
0x4044:030 (P753.30)	Parameter value set 3: Value of parameter 30 (Par. value set 3: Set 3 - Value 30) -2147483648 ... [0] ... 2147483647	
0x4044:031 (P753.31)	Parameter value set 3: Value of parameter 31 (Par. value set 3: Set 3 - Value 31) -2147483648 ... [0] ... 2147483647	
0x4044:032 (P753.32)	Parameter value set 3: Value of parameter 32 (Par. value set 3: Set 3 - Value 32) -2147483648 ... [0] ... 2147483647	

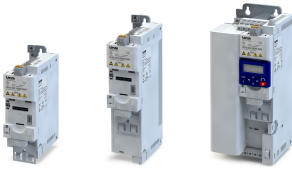

Additional functions

Parameter change-over
Configuring the "Favorites"

Parameter	Name / value range / [default setting]	Info
0x4045:001 (P754.01)	Parameter value set 4: Value of parameter 1 (Par. value set 4: Set 4 - Value 1) -2147483648 ... [0] ... 2147483647	Value set 4 for the parameter list defined in 0x4041:001 (P750.01).
0x4045:002 (P754.02)	Parameter value set 4: Value of parameter 2 (Par. value set 4: Set 4 - Value 2) -2147483648 ... [0] ... 2147483647	
0x4045:003 (P754.03)	Parameter value set 4: Value of parameter 3 (Par. value set 4: Set 4 - Value 3) -2147483648 ... [0] ... 2147483647	
0x4045:004 (P754.04)	Parameter value set 4: Value of parameter 4 (Par. value set 4: Set 4 - Value 4) -2147483648 ... [0] ... 2147483647	
0x4045:005 (P754.05)	Parameter value set 4: Value of parameter 5 (Par. value set 4: Set 4 - Value 5) -2147483648 ... [0] ... 2147483647	
0x4045:006 (P754.06)	Parameter value set 4: Value of parameter 6 (Par. value set 4: Set 4 - Value 6) -2147483648 ... [0] ... 2147483647	
0x4045:007 (P754.07)	Parameter value set 4: Value of parameter 7 (Par. value set 4: Set 4 - Value 7) -2147483648 ... [0] ... 2147483647	
0x4045:008 (P754.08)	Parameter value set 4: Value of parameter 8 (Par. value set 4: Set 4 - Value 8) -2147483648 ... [0] ... 2147483647	
0x4045:009 (P754.09)	Parameter value set 4: Value of parameter 9 (Par. value set 4: Set 4 - Value 9) -2147483648 ... [0] ... 2147483647	
0x4045:010 (P754.10)	Parameter value set 4: Value of parameter 10 (Par. value set 4: Set 4 - Value 10) -2147483648 ... [0] ... 2147483647	
0x4045:011 (P754.11)	Parameter value set 4: Value of parameter 11 (Par. value set 4: Set 4 - Value 11) -2147483648 ... [0] ... 2147483647	
0x4045:012 (P754.12)	Parameter value set 4: Value of parameter 12 (Par. value set 4: Set 4 - Value 12) -2147483648 ... [0] ... 2147483647	
0x4045:013 (P754.13)	Parameter value set 4: Value of parameter 13 (Par. value set 4: Set 4 - Value 13) -2147483648 ... [0] ... 2147483647	
0x4045:014 (P754.14)	Parameter value set 4: Value of parameter 14 (Par. value set 4: Set 4 - Value 14) -2147483648 ... [0] ... 2147483647	
0x4045:015 (P754.15)	Parameter value set 4: Value of parameter 15 (Par. value set 4: Set 4 - Value 15) -2147483648 ... [0] ... 2147483647	
0x4045:016 (P754.16)	Parameter value set 4: Value of parameter 16 (Par. value set 4: Set 4 - Value 16) -2147483648 ... [0] ... 2147483647	
0x4045:017 (P754.17)	Parameter value set 4: Value of parameter 17 (Par. value set 4: Set 4 - Value 17) -2147483648 ... [0] ... 2147483647	
0x4045:018 (P754.18)	Parameter value set 4: Value of parameter 18 (Par. value set 4: Set 4 - Value 18) -2147483648 ... [0] ... 2147483647	
0x4045:019 (P754.19)	Parameter value set 4: Value of parameter 19 (Par. value set 4: Set 4 - Value 19) -2147483648 ... [0] ... 2147483647	
0x4045:020 (P754.20)	Parameter value set 4: Value of parameter 20 (Par. value set 4: Set 4 - Value 20) -2147483648 ... [0] ... 2147483647	
0x4045:021 (P754.21)	Parameter value set 4: Value of parameter 21 (Par. value set 4: Set 4 - Value 21) -2147483648 ... [0] ... 2147483647	

Additional functions

Parameter change-over
Configuring the "Favorites"



Parameter	Name / value range / [default setting]	Info
0x4045:022 (P754.22)	Parameter value set 4: Value of parameter 22 (Par. value set 4: Set 4 - Value 22) -2147483648 ... [0] ... 2147483647	
0x4045:023 (P754.23)	Parameter value set 4: Value of parameter 23 (Par. value set 4: Set 4 - Value 23) -2147483648 ... [0] ... 2147483647	
0x4045:024 (P754.24)	Parameter value set 4: Value of parameter 24 (Par. value set 4: Set 4 - Value 24) -2147483648 ... [0] ... 2147483647	
0x4045:025 (P754.25)	Parameter value set 4: Value of parameter 25 (Par. value set 4: Set 4 - Value 25) -2147483648 ... [0] ... 2147483647	
0x4045:026 (P754.26)	Parameter value set 4: Value of parameter 26 (Par. value set 4: Set 4 - Value 26) -2147483648 ... [0] ... 2147483647	
0x4045:027 (P754.27)	Parameter value set 4: Value of parameter 27 (Par. value set 4: Set 4 - Value 27) -2147483648 ... [0] ... 2147483647	
0x4045:028 (P754.28)	Parameter value set 4: Value of parameter 28 (Par. value set 4: Set 4 - Value 28) -2147483648 ... [0] ... 2147483647	
0x4045:029 (P754.29)	Parameter value set 4: Value of parameter 29 (Par. value set 4: Set 4 - Value 29) -2147483648 ... [0] ... 2147483647	
0x4045:030 (P754.30)	Parameter value set 4: Value of parameter 30 (Par. value set 4: Set 4 - Value 30) -2147483648 ... [0] ... 2147483647	
0x4045:031 (P754.31)	Parameter value set 4: Value of parameter 31 (Par. value set 4: Set 4 - Value 31) -2147483648 ... [0] ... 2147483647	
0x4045:032 (P754.32)	Parameter value set 4: Value of parameter 32 (Par. value set 4: Set 4 - Value 32) -2147483648 ... [0] ... 2147483647	
0x4046 (P755.00)	Activation of parameter set (PSet activation)	Selection of the activation method for the parameter change-over. <ul style="list-style-type: none"> If the selection is changed from "Via command... [0]/[1]" to "If the selection is changed...[2]/[3]" after switch-on, the parameter set selected via the functions "Select parameter set (bit 0)" and "Select parameter set (bit 1)" is activated immediately. In case of selection [2], however, this only takes place if the inverter is disabled, the motor is stopped or an error is active.
	0 Via command (disable required)	The parameter set selected via the functions "Select parameter set (bit 0)" and "Select parameter set (bit 1)" is activated if the trigger assigned to the "Load parameter set" function in 0x2631:040 (P400.40) provides a FALSE-TRUE edge AND the inverter is inhibited, the motor is stopped or an error is active.
	1 Via command (immediately)	The parameter set selected via the functions "Select parameter set (bit 0)" and "Select parameter set (bit 1)" is immediately activated if the trigger assigned to the "Load parameter set" function in 0x2631:040 (P400.40) provides a FALSE-TRUE edge.
	2 If the selection is changed (disable required)	The parameter set selected via the functions "Select parameter set (bit 0)" and "Select parameter set (bit 1)" is activated if the state of these selection bits changes AND the inverter is inhibited, the motor is stopped or an error is active.
	3 If the selection is changed (immediately)	The parameter set selected via the functions "Select parameter set (bit 0)" and "Select parameter set (bit 1)" is activated immediately if the state of these selection bits is changed.



Additional functions

Parameter change-over Configuring the "Favorites"

Parameter	Name / value range / [default setting]	Info
0x4047:001 (P756.01)	Parameter change-over error message: Status (PSet error msg.: Status) • Read only	Error message for the "parameter change-over" function. <ul style="list-style-type: none"> In the event of an error, an error status is shown here, and in 0x4047:002 (P756.02) the number of the list entry in which the error has occurred is displayed (in connection with the value set selected). If several errors occur at the same time, only the first incorrect list entry will be displayed. Hence, after elimination of the displayed error and repeated activation, more errors may be displayed. The parameter list will always be processed from beginning to end, even if errors occur in the meantime.
	0 No fault	
	33803 Invalid data type	
	33804 Range violation	
	33806 Invalid index	
	33813 No element selected	
	33815 Writing impermissible	
	33816 Device not inhibited	
	33829 Invalid subindex	
	33837 Access impermissible	
	33860 Parameter not mappable	
33865 No subindexes		
33876 Parameter not changeable		
0x4047:002 (P756.02)	Parameter change-over error message: List entry (PSet error msg.: List entry) • Read only	Error message for the "Parameter set changeover" function. <ul style="list-style-type: none"> In the event of an error, the number of the list entry for which the error displayed in 0x4047:001 (P756.01) has occurred is shown here.
0x2631:040 (P400.40)	Function list: Load parameter set (Function list: Load param.set) • Setting can only be changed if the inverter is inhibited. • For further possible settings, see parameter 0x2631:001 (P400.01) . 500	Assignment of a trigger for the "Load parameter set" function. Trigger = FALSE-TRUE edge: parameter change-over to the value set selected via "Select parameter set (bit 0)" and "Select parameter set (bit 1)". Trigger = FALSE: no action. Notes: <ul style="list-style-type: none"> The activation method for the "Parameter change-over" function can be selected in 0x4046 (P755.00).
	0 Not connected	No trigger assigned (trigger is constantly FALSE).
0x2631:041 (P400.41)	Function list: Select parameter set (bit 0) (Function list: Sel. paramset b0) • Setting can only be changed if the inverter is inhibited. • For further possible settings, see parameter 0x2631:001 (P400.01) . 500	Assignment of a trigger for the "Select parameter set (bit 0)" function. Selection bit with the valency 2^0 for "Parameter change-over" function. Trigger = FALSE: selection bit = "0". Trigger = TRUE: selection bit = "1".
	0 Not connected	No trigger assigned (trigger is constantly FALSE).
0x2631:042 (P400.42)	Function list: Select parameter set (bit 1) (Function list: Sel. paramset b1) • Setting can only be changed if the inverter is inhibited. • For further possible settings, see parameter 0x2631:001 (P400.01) . 500	Assignment of a trigger for the "Select parameter set (bit 1)" function. Selection bit with the valency 2^1 for "Parameter change-over" function. Trigger = FALSE: selection bit = "0". Trigger = TRUE: selection bit = "1".
	0 Not connected	No trigger assigned (trigger is constantly FALSE).

Additional functions

Parameter change-over

Example: Selective control of several motors with one inverter



10.9.1 Example: Selective control of several motors with one inverter

A typical application for the parameter change-over is an application/machine in which several axes must be triggered successively but a simultaneous operation of several motors is not required. In this case, one and the same inverter can trigger the motors in succession. Advantages of this solution are the reduced amount of components (inverters) and thus a reduced energy consumption.

Principle:

- The motor to be currently controlled is connected to the inverter via motor contactors. (The contactor system can, for instance, be controlled via the digital outputs of the inverter.)
- At the same time, the motor and control settings suitable for motor are activated in the inverter by means of parameter change-over. ▶ [Functions for parameter change-over](#)

550

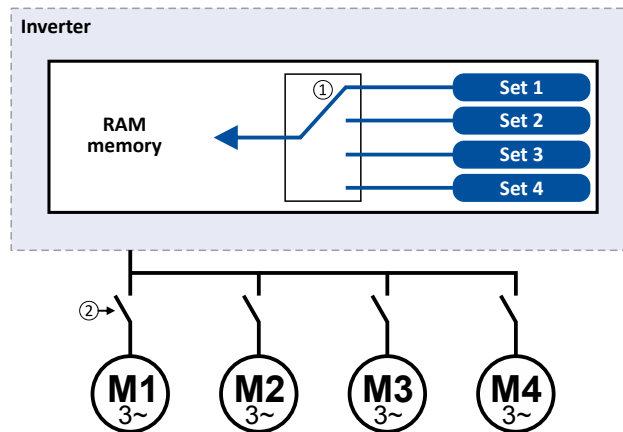

- ① Motor data change-over (via the "parameter change-over" function)
- ② Motor change-over (e.g. via motor contactors)

The following table lists all parameters that require different settings for the four motors:

#	Parameter	Name	Setting			
			M1	M2	M3	M4
1	0x2B00 (P302.00)	V/f characteristic shape	Linear [0]	Square-law [1]	Linear [0]	Linear [0]
2	0x2B01:002 (P303.02)	Base frequency	60 Hz	60 Hz	60 Hz	50 Hz
3	0x2D4B:001 (P308.01)	Maximum utilisation [60 s]	150 %	120 %	150 %	150 %
4	0x2B12:001 (P316.01)	Fixed boost	2.5 %	0.0 %	4.0 %	2.0 %
5	0x2C01:004 (P320.04)	Rated speed	1745	3450	1750	1450
6	0x2C01:005 (P320.05)	Rated frequency	60.0 Hz	60.0 Hz	60.0 Hz	50.0 Hz
7	0x2C01:006 (P320.06)	Rated power	0.75 kW	0.75 kW	0.75 kW	1.50 kW
8	0x2C01:007 (P320.07)	Rated voltage	480 V	480 V	480 V	400 V
9	0x6075 (P323.00)	Motor rated current	2,200 A	2,100 A	2,200 A	3,500 A
10	0x6073 (P324.00)	Max current	200.0 %	150.0 %	200.0 %	200.0 %



Additional functions

Parameter change-over

Example: Selective control of several motors with one inverter

Settings required for the "parameter change-over" function

The easiest way to make the required settings is via the parameterisation dialog in the »EASY Starter«:

1. Click the button to first select the 10 relevant parameters.
2. Set values for motor M1 ... M4 in the corresponding fields:

Zeile	Adresse	Display Code	Name	Einheit	Aktiver Wert	Wert 1	Wert 2	Wert 3	Wert 4
1	0x2B00:000	P302:000	V/f characteristic shape		Linear [0]	Linear [0]	Quadratic [1]	Linear [0]	Linear [0]
2	0x2B01:002	P303:002	V/f shape data: Base frequency	Hz	50	50	50	50	50
3	0x2D4B:001	P308:001	Motor overload monit. (i ²): Maxim...	%	150	150	150	150	150
4	0x2B12:001	P316:001	V/f voltage boost: Fixed boost	%	2.5	2.5	0.0	4.0	2.0
5	0x2C01:004	P320:004	Motor parameters: Rated speed	rpm	1745	1745	3450	1750	1450
6	0x2C01:005	P320:005	Motor parameters: Rated frequency	Hz	60.0	60.0	60.0	60.0	50.0
7	0x2C01:006	P320:006	Motor parameters: Rated power	kW	0.75	0.75	0.75	0.75	1.50
8	0x2C01:007	P320:007	Motor parameters: Rated voltage	V	480	480	480	480	400
9	0x6075:000	P323:000	Motor rated current	A	2.200	2.200	2.100	2.200	3.500
10	0x6073:000	P324:000	Max current	%	200.0	200.0	150.0	200.0	200.0

In case of a direct setting in the parameters of the "parameter change-over" function:

- The addresses must be set with the following format: 0xiiii00 (iiii = index hexadecimal, ss = subindex hexadecimal). The keypad serves to select the desired parameter from a list.
- The values for the motors must be set as integer values. The integer value results from the multiplication of the actual setting value by the factor of the respective parameter. In the , the factor for each parameter must be given.

The following table shows the required settings:

#	Address 0x4041:x (PAR 750/x)		Name	Value 1 0x4042:x (PAR 752/x)	Value 2 0x4043:x (PAR 753/x)	Value 3 0x4044:x (PAR 754/x)	Value 4 0x4045:x (PAR 755/x)
	hex	decimal					
1	0x2B000000	721420288	V/f characteristic shape	0	1	0	0
2	0x2B010200	721486336	Base frequency	60	60	60	50
3	0x2D4B0100	759890176	Maximum utilisation [60 s]	150	120	150	150
4	0x2B120100	722600192	Fixed boost	25	0	40	20
5	0x2C010400	738264064	Rated speed	1745	3450	1750	1450
6	0x2C010500	738264320	Rated frequency	600	600	600	500
7	0x2C010600	738264576	Rated power	75	75	75	150
8	0x2C010700	738264832	Rated voltage	480	480	480	400
9	0x60750000	1618280448	Motor rated current	2200	2100	2200	3500
10	0x60730000	1618149376	Max current	2000	1500	2000	2000

Additional functions

Device profile CiA 402



10.10 Device profile CiA 402

The CiA® 402 device profile defines the functional behaviour of stepping motors, servo drives, and frequency inverters. In order to be able to describe the different drive types, various operating modes and device parameters are specified in the device profile. Each operating mode provides objects (e.g. for the setpoint speed, acceleration and deceleration) to generate the desired drive behaviour.

Details

The CiA 402 operating mode "CiA: Velocity mode" is activated by the setting **0x6060 (P301.00)** = "CiA: Velocity mode [2]".



More details can be found in the CiA 402 specification (CANopen device profile for drives and Motion Control) of the CAN in Automation (CiA) user organisation.

<http://www.can-cia.org>

CiA® is a registered community trademark of the CAN in Automation e. V user organisation.

Parameter	Name / value range / [default setting]	Info
0x6042 (P781.00)	Target velocity (Target velocity) -32768 ... [0] ... 32767 rpm	Setpoint speed (velocity mode).
0x6043 (P782.00)	Velocity demand (Velocity demand) • Read only: x rpm	Display of the setpoint velocity (velocity mode).
0x6044 (P783.00)	Velocity actual value (Velocity actual) • Read only: x rpm	Display of the actual speed (velocity mode).
0x6046:001 (P784.01)	Velocity min max amount: Velocity min amount (Vel. min max: Vel. min amount) 0 ... [0] ... 480000 rpm	Minimum speed (velocity mode).
0x6046:002 (P784.02)	Velocity min max amount: Velocity max amount (Vel. min max: Vel. max amount) 0 ... [2147483647] ... 2147483647 rpm	Maximum speed (velocity mode).
0x6048:001 (P785.01)	Velocity acceleration: Delta speed (Vel.acceleration: Delta speed) 0 ... [3000] ... 2147483647 rpm	Acceleration: speed interval
0x6048:002 (P785.02)	Velocity acceleration: Delta time (Vel.acceleration: Delta time) 0 ... [10] ... 65535 s	Acceleration: time interval
0x6049:001 (P786.01)	Velocity deceleration: Delta speed (Vel.deceleration: Delta speed) 0 ... [3000] ... 2147483647 rpm	Deceleration: speed interval
0x6049:002 (P786.02)	Velocity deceleration: Delta time (Vel.deceleration: Delta time) 0 ... [10] ... 65535 s	Deceleration: time interval
0x605A	Quick stop option code	Device status after exiting the quick stop ramp. • Setting is only effective in the operating mode 0x6060 (P301.00) = "CiA: Velocity mode [2]".
	2 Quick stop ramp -> switch-on inhibited	Automatic change to the "Switch-on inhibited" device state. • The "Quick stop active [54]" status is reset to FALSE after ramp-down to standstill.
	6 Quick stop ramp -> quick stop active	The inverter remains in the "Quick stop active" device state. • The "Quick stop active [54]" status remains TRUE until the "Quick stop" function is activated.



Additional functions

Device profile CiA 402

Parameter	Name / value range / [default setting]	Info
0x605E (P791.00)	Fault reaction option code (Fault reaction)	Selection of the response to faults.
	-2 DC braking	The motor is brought to a standstill by means of the "DC braking" function. ▶ DC braking □ 386
	0 Coasting	The motor becomes torqueless (coasts down to standstill).
	2 Quick stop	The motor is brought to a standstill with the "quick stop" function. • In the operating mode 0x6060 (P301.00) = "MS: Velocity mode [-2]", the deceleration time set in 0x291C (P225.00) is effective. • In the operating mode 0x6060 (P301.00) = "CiA: Velocity mode [2]", the speed change set in 0x6085 (P790.00) is effective.
0x6060 (P301.00)	Modes of operation (Modes of op.) • Setting can only be changed if the inverter is inhibited.	Selection of the operating mode.
	-2 MS: Velocity mode	Vendor specific velocity mode
	-1 MS: Torque mode (from version 03.00)	Vendor specific torque mode • Only possible in motor control type 0x2C00 (P300.00) = "Sensorless vector control (SLVC) [4]". ▶ Torque control w/ freq. limit □ 179
	0 No mode change/no mode assigned	No operating mode (standstill)
0x6061 (P788.00)	Modes of operation display (Modes of op. dis) • Read only	Display of the current operating mode.
	-2 MS: Velocity mode	Vendor specific velocity mode
	-1 MS: Torque mode (from version 03.00)	Vendor specific torque mode
	0 No mode change/no mode assigned	No operating mode (standstill)
0x6071	Target torque -3276.8 ... [0.0] ... 3276.7 %	Setpoint torque for the "MS: Torque mode" operating mode. • 100 % ≙ Motor rated torque 0x6076 (P325.00)
	0x6074	Torque demand value • Read only: x.x % • From version 02.00
0x6079	DC link circuit voltage • Read only: x.xxx V • From version 02.00	Display of the current DC-bus voltage.
0x6085 (P790.00)	Quick stop deceleration (Quick stop dec.) 0 ... [546000] ... 2147483647 pos. unit/s ²	Change in velocity used for deceleration to a standstill if quick stop is activated. • Setting is only effective in the operating mode 0x6060 (P301.00) = "CiA: Velocity mode [2]". • In operating mode 0x6060 (P301.00) = "MS: Velocity mode [-2]", the deceleration time set in 0x291C (P225.00) is effective. $0x6085 = ((\text{initial speed of the motor [rpm]}) / (\text{duration of the ramp until standstill [s]})) * 1092$
0x6502 (P789.00)	Supported drive modes (Supported modes) • Read only	Bit-coded display of the operating modes supported.
	Bit 0 Reserved	-
	Bit 1 CiA: Velocity mode	1 ≙ CiA 402 velocity mode is supported.
	Bit 2 Reserved	-
	Bit 3 Reserved	-
	Bit 5 Reserved	-
	Bit 6 Reserved	-
	Bit 7 Cyclic sync position mode	Always 0 (not supported).
	Bit 8 Cyclic sync velocity mode	Always 0 (not supported).
	Bit 9 Cyclic sync torque mode	Always 0 (not supported).
Bit 17 MS: Velocity mode	1 ≙ vendor specific velocity mode is supported.	

Additional functions

Device profile CiA 402





Parameter	Name / value range / [default setting]	Info
0x6040	CiA: Controlword 0 ... [0] ... 65535	Mappable CiA 402 control word with bit assignment according to device profile CiA 402.
	Bit 0 Switch on	1 = switch-on
	Bit 1 Enable voltage	1 = DC bus: Establish readiness for operation
	Bit 2 Quick stop	0 = activate quick stop
	Bit 3 Enable operation	1 = enable operation
	Bit 4 Operation mode specific	Bits are not supported.
	Bit 5 Operation mode specific	
	Bit 6 Operation mode specific	
	Bit 7 Fault reset	0-1 edge = reset error
	Bit 8 Halt (from version 04.00)	1 = stop motor (ramping down to frequency setpoint 0 Hz)
	Bit 9 Operation mode specific	Operating mode dependent
Bit 14 Release holding brake	1 = releasing holding brake manually ⚠ CAUTION! <ul style="list-style-type: none"> The manually triggered "Release holding brake" command has a direct impact on the "Release holding brake [115]" trigger. Thus, the holding brake can be manually released if the power section is switched off. The responsibility for a manual release of the holding brake has the external trigger source for the "Release holding brake" command. ▶ Holding brake control 429	
0x6041 (P780.00)	CiA: Statusword (CiA: Statusword) • Read only	Mappable CiA 402 status word with bit assignment according to device profile CiA 402.
	Bit 0 Ready to switch on	1 ≡ drive ready to start
	Bit 1 Switched on	1 ≡ drive switched-on
	Bit 2 Operation enabled	1 ≡ operation enabled
	Bit 3 Fault	1 ≡ fault or trouble active
	Bit 4 Voltage enabled	1 ≡ DC bus ready for operation
	Bit 5 Quick stop	0 ≡ quick stop active
	Bit 6 Switch on disabled	1 ≡ operation inhibited
	Bit 7 Warning	1 ≡ warning active
	Bit 8 RPDOs deactivated	1 ≡ cyclic PDOs have been deactivated.
	Bit 9 Remote	1 ≡ inverter can receive commands via network. <ul style="list-style-type: none"> Bit is not set in the operating mode 0x6060 (P301.00) = "MS: Velocity mode [-2]".
	Bit 10 Target reached	1 ≡ the actual position is in the window.
	Bit 11 Internal limit active	1 ≡ internal limitation of a setpoint active.
	Bit 14 Holding brake released	1 ≡ holding brake released
	Bit 15 Safe torque off (STO) not active	0 ≡ STO active 1 ≡ STO not active



10.11 Holding brake control

This function serves as a low-wear control of a holding brake. The holding is usually mounted to the motor as an option. The holding brake can be automatically released via the start command for the inverter or manually via an external control signal, for instance, by a higher-level Controller. The interaction of higher-level Controller and holding brake is especially important for vertical applications. Horizontal applications need a less demanding holding brake control.

Preconditions

- Observe that the holding brake is an important element of the machine's safety concept as a whole. Therefore be sure to carry out commissioning of this system part with particular care!
- Holding brakes are not intended for braking during operation. The increased wear caused by braking during operation may destroy the holding brake prematurely!
- The holding brake control itself only outputs a digital trigger for releasing the holding brake. This trigger "Release holding brake [115]" must be assigned to a digital output or, in the simplest case, to the relay when then switches the brake supply. ▶ [Configuration of digital outputs](#)  574
- If the holding brake is to be controlled via a digital output, the use of an additional relay or power contactor is required. The digital output is not suited for direct control of a holding brake.
- If, instead of an electrically releasing (self-holding) holding brake, an electrically holding (self-releasing) holding brake is to be controlled, a signal inversion for the digital output used or for the relay is to be set! ▶ [Configuration of digital outputs](#)  574

Parameter	Name / value range / [default setting]	Info
0x2634:001 (P420.01)	Digital outputs function: Relay (Dig.out.function: Relay function) <ul style="list-style-type: none"> • For further possible settings, see parameter 0x2634:001 (P420.01).  574 	Assignment of a trigger to the relay. Trigger = FALSE: X9/NO-COM open and NC-COM closed. Trigger = TRUE: X9/NO-COM closed and NC-COM open. Notes: <ul style="list-style-type: none"> • An inversion set in 0x2635:001 (P421.01) is taken into consideration here.
	51 Ready for operation	TRUE if inverter is ready for operation (no error active, no STO active and DC-bus voltage ok). Otherwise FALSE.

Additional functions

Holding brake control
Basic setting



10.11.1 Basic setting

The following parameters must be set for the activation and basic setting of the holding brake control.



When a power contactor is used, the response time and release time of the contactor are added to the brake application and release time. Both times must also be taken into consideration for parameterising the brake application time and brake opening time!

Parameter	Name / value range / [default setting]	Info
0x2820:001 (P712.01)	Holding brake control: Brake mode (Brake control: Brake mode)	Selecting how the "Release holding brake" command is to be triggered.
	0 Automatically (via device state)	"Automatic operation": The "Release holding brake" command is automatically carried out as a function of the device state and further conditions. ⚠ CAUTION! Also in the automatic operation, a manual release of the holding brake is possible! For details see the following information for selection "Manually [1]".
	1 Manually	The "Release holding brake" command can also be initiated by the following external triggers: <ul style="list-style-type: none"> • Via the trigger assigned to the "Release holding brake" function in 0x2631:049 (P400.49) if the network control is not active. • Via bit 14 in the CiA 402 control word 0x6040 if the network control is active. ⚠ CAUTION! <ul style="list-style-type: none"> • The manually triggered "Release holding brake" command has a direct impact on the "Release holding brake [115]" trigger. Thus, the holding brake can be manually released if the power section is switched off! • The responsibility for a manual release of the holding brake has the external trigger source for the "Release holding brake" command!
	2 Off	The holding brake is deactivated.
0x2820:002 (P712.02)	Holding brake control: Brake closing time (Brake control: Closing time) 0 ... [100] ... 10000 ms	Application time (engagement time) of the holding brake. <ul style="list-style-type: none"> • Only effective in automatic operation.
0x2820:003 (P712.03)	Holding brake control: Brake opening time (Brake control: Opening time) 0 ... [100] ... 10000 ms	Release time (disengagement time) of the holding brake. <ul style="list-style-type: none"> • Only effective in automatic operation.
0x2820:015 (P712.15)	Holding brake control: Brake status (Brake control: Brake status) <ul style="list-style-type: none"> • Read only 	Display of the holding brake status. <ul style="list-style-type: none"> • The status is also displayed via bit 14 in the CiA: Statusword 0x6041 (P780.00).
	0 Active	Holding brake is applied.
	1 Brake released	Holding brake is released.

For examples and details on more possible settings, see the following subchapter:

- ["Automatic" brake mode \(automatic operation\)](#) 431
- [Brake holding load](#) 433
- [Brake closing level](#) 435
- [Manual release of the holding brake](#) 437



Additional functions

Holding brake control
 "Automatic" brake mode (automatic operation)

10.11.2 "Automatic" brake mode (automatic operation)

In automatic operation, the inverter automatically released the holding brake when the motor is started. In the stopped state, the holding brake is closed.

⚠ DANGER!

Manual release of the holding brake

Also in automatic operation, a manual release of the holding brake is possible. The manually triggered "Release holding brake" command has a direct impact on the "Release holding brake [115]" trigger. Thus, the holding brake can be manually released if the power section is switched off.

- ▶ The responsibility for a manual release of the holding brake has the external trigger source for the "Release holding brake" command!

Preconditions

Automatic operation is only available if the operating mode "MS: Velocity mode [-2]" or "MS: Torque mode [-1]" is set in [0x6060 \(P301.00\)](#).

Parameter	Name / value range / [default setting]	Info
0x6060 (P301.00)	Modes of operation (Modes of op.) • Setting can only be changed if the inverter is inhibited.	Selection of the operating mode.
	-2 MS: Velocity mode	Vendor specific velocity mode
	-1 MS: Torque mode (from version 03.00)	Vendor specific torque mode • Only possible in motor control type 0x2C00 (P300.00) = "Sensorless vector control (SLVC) [4]". ▶ Torque control w/ freq. limit □ 179
	0 No mode change/no mode assigned	No operating mode (standstill)
2	CiA: Velocity mode	CiA 402 velocity mode

Additional functions

Holding brake control
 "Automatic" brake mode (automatic operation)

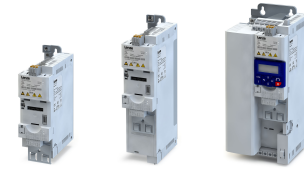

General mode of operation

The following diagram demonstrates the general functioning of the automatic operation:

Input signals

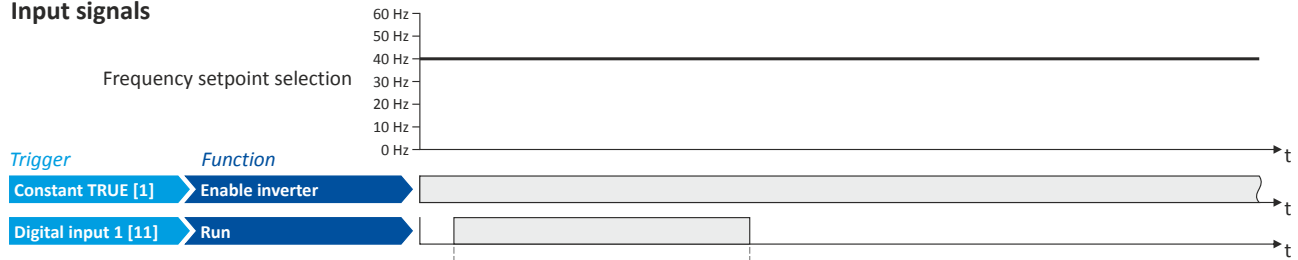

Output signals

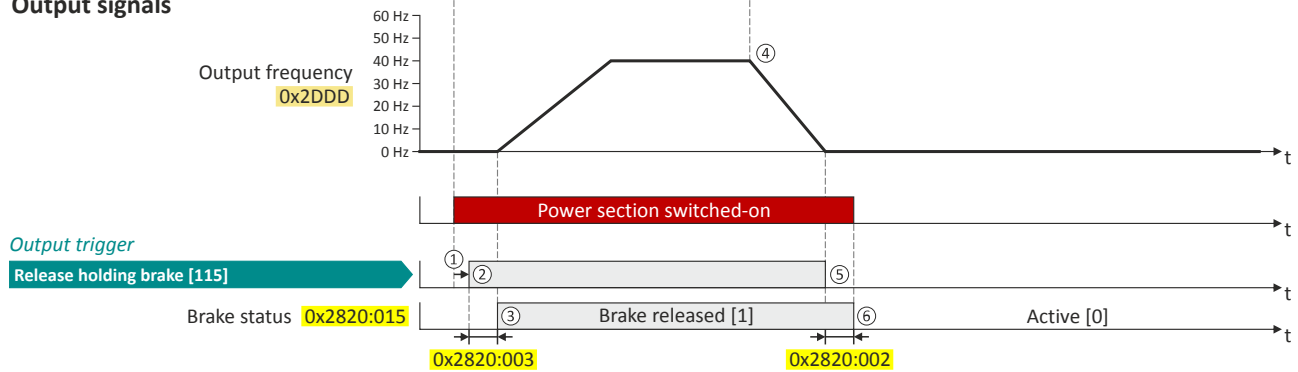

- ① If the inverter is enabled and no error is active, the motor can be started with the "Run" function in forward rotating direction. The power section is switched on and the motor is magnetised first.
- ② The holding brake is released. For this purpose, the output trigger "Release holding brake [115]" is set to TRUE. This trigger must be assigned to a digital output or, in the simplest case, to the relay which then switches the brake supply.
- ③ After the release time 0x2820:003 (P712.03) has elapsed, the motor is accelerated to the setpoint. The brake status "Brake released [1]" is displayed in 0x2820:015 (P712.15).
- ④ If "Run" is set to FALSE, the motor is stopped with the stop method set in 0x2838:003 (P203.03). In the example: Stop with standard ramp.
- ⑤ Then the holding brake is closed again.
- ⑥ After the closing time 0x2820:002 (P712.02) has elapsed, the brake status "Active [0]" is displayed in 0x2820:015 (P712.15).



If the power section is disabled, the holding brake is closed. Reasons for this can be an error, a fault, or the activation of the "Safe torque off (STO)" safety function.



10.11.3 Brake holding load

Depending on the application, a torque at the motor may be required at speed "0" of the motor shaft:

- In order to hold loads in vertical applications and prevent "sagging".
- In order to prevent a position loss in horizontal applications.

For this purpose, a brake holding load can be set. The brake holding load can be optionally generated via a ramp to reduce a vibration stimulation that may be caused by the brake holding load.

Preconditions

Ensure that the inverter builds up a sufficient torque in the motor when releasing and applying the holding, in order to hold the load.

- For this purpose, a V/f voltage boost can be set for the V/f characteristic control. ▶ [V/f voltage boost](#) □ 155
- The parameters for the V/f voltage boost are automatically set when you carry out an automatic identification of the motor.

Details

Relevant parameters:

- [0x2820:008 \(P712.08\)](#): Brake holding load
- [0x2820:013 \(P712.13\)](#): Holding load ramptime

Setting notes:

- In case of applications with constant load, a constant value is suitable for the brake holding load.
- If the load constantly changes, a approximate value for the brake holding load has to be considered.
- Start with the setting "0 %" if you do not know the correct direction, otherwise with, for instance, "30 %". Afterwards change the setting upwards or downwards in 10-% steps.

Parameter	Name / value range / [default setting]	Info
0x2820:008 (P712.08)	Holding brake control: Brake holding load (Brake control: Holding load) -500.0 ... [0.0] ... 500.0 %	By setting a holding load, the load can be held against the force of gravity in case of vertical applications, and a position loss can be prevented in case of horizontal applications. <ul style="list-style-type: none"> • The setting of "100 %" approximately corresponds to rated motor torque and slip frequency. <p>Note!</p> <p>The torque for creating the holding load depends on the selected motor control type and its settings. Before using this function, make sure that you have set the motor control type correctly.</p>
0x2820:013 (P712.13)	Holding brake control: Holding load ramptime (Brake control: HoldLoad ramptim) 0 ... [0] ... 100 ms <ul style="list-style-type: none"> • From version 03.00 	By setting a ramp time, a vibration stimulation can be reduced that might be caused by the brake holding load 0x2820:008 (P712.08) .

Additional functions

Holding brake control
Brake holding load



General mode of operation

The following diagram demonstrates the general functioning in automatic operation:

Input signals

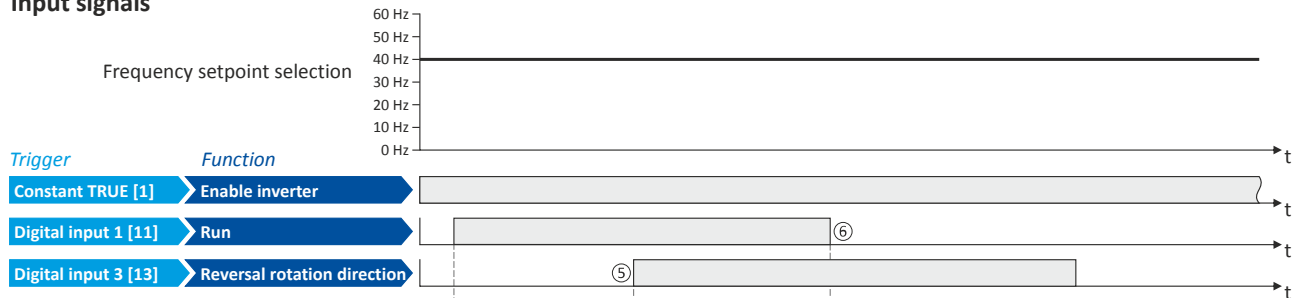

Output signals

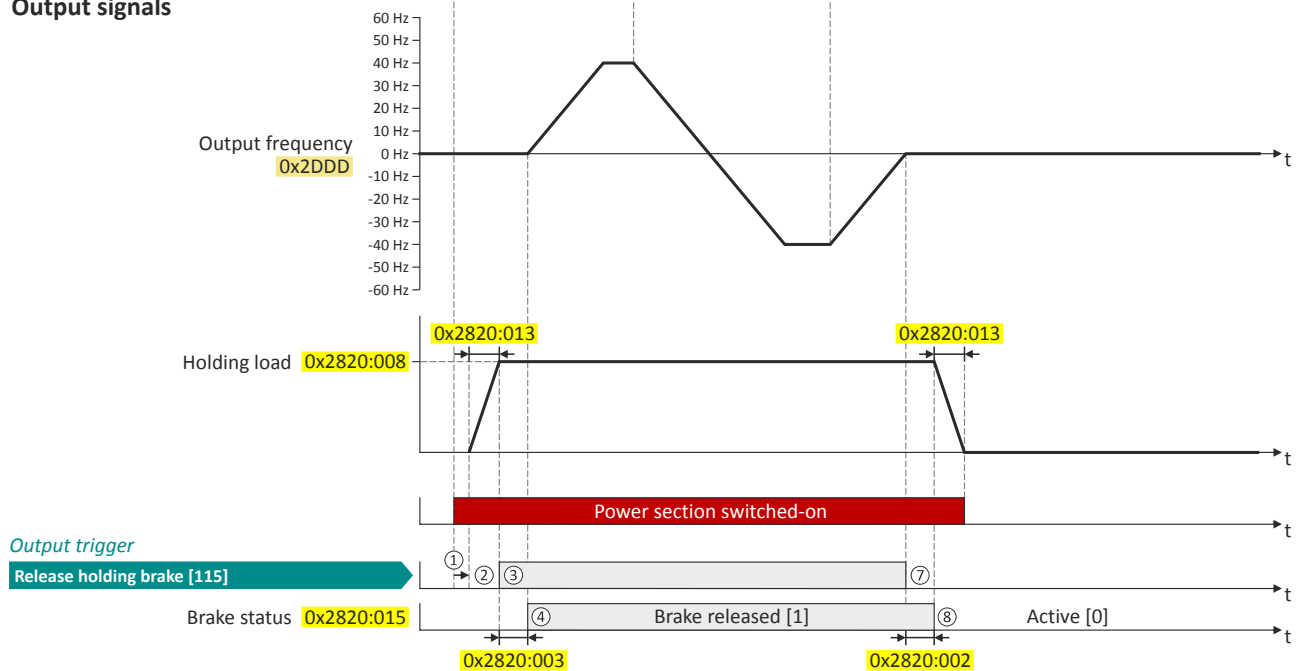

- ① If the inverter is enabled and no error is active, the motor can be started with the "Run" function in forward rotating direction. The power section is switched on and the motor is magnetised first.
- ② The brake holding load set in 0x2820:008 (P712.08) is build up via the ramp set in 0x2820:013 (P712.13).
- ③ The holding brake is released. For this purpose, the output trigger "Release holding brake [115]" is set to TRUE. This trigger must be assigned to a digital output or, in the simplest case, to the relay which then switches the brake supply.
- ④ After the release time 0x2820:003 (P712.03) has elapsed, the motor is accelerated to the setpoint. The brake status "Brake released [1]" is displayed in 0x2820:015 (P712.15).
- ⑤ In case the direction of rotation reverses, the holding brake remains released.
- ⑥ If "Run" is set to FALSE, the motor is stopped with the stop method set in 0x2838:003 (P203.03). In the example: Stop with standard ramp.
- ⑦ Then the holding brake is closed again.
- ⑧ After the closing time 0x2820:002 (P712.02) has elapsed, the brake status "Active [0]" is displayed in 0x2820:015 (P712.15). The brake holding load is reduced again via the ramp.



10.11.4 Brake closing level

In some cases, a low speed does not make any sense from the application point of view. This includes applications with unfavorable load features, such as static friction. In such applications and depending on the type of control, a low speed may cause an unwanted behaviour. In order to prevent such an operating situation, a closing threshold can be set. The power section will only be switched on and the holding brake is opened if the setpoint is higher than the closing threshold. In order to prevent the holding brake from being closed if the setpoint only shortly falls below the closing threshold during operation, a delay time can be set in addition.

Preconditions

If the holding brake is controlled manually via an external control signal: It must be ensured that the motor does not move while the motor control is deactivated by this function.

Details

The function is part of the holding brake control and does not have an independent functionality.

Relevant parameters:

- [0x2820:007 \(P712.07\)](#): Brake closing threshold
- [0x2820:012 \(P712.12\)](#): Closing threshold delay

Setting notes:

- The function is active if the brake closing threshold is higher than 0 Hz.
- In order that the brake can work correctly, the brake closing threshold must be set to a value that is greater than or equals the minimum frequency [0x2915 \(P210.00\)](#).
- The brake closing threshold has a permanent hysteresis of 1 Hz in order to prevent an unwanted change-over. Exception: If the brake closing threshold is set to 0 Hz, the hysteresis is also 0 Hz.
- If the brake closing threshold is set to 0 Hz, a start command is only required to release the holding brake during automatic operation.
- This function can be combined with the setting of a holding load.

Parameter	Name / value range / [default setting]	Info
0x2820:007 (P712.07)	Holding brake control: Brake closing threshold (Brake control: Closing thresh.) 0.0 ... [0.2] ... 599.0 Hz	Threshold for closing the holding brake. <ul style="list-style-type: none"> • The power section will only be switched on and the holding brake will be opened if the setpoint is higher than the threshold set here. • In order that the brake can work correctly, the brake closing threshold must be set to a value that is greater than or equals the minimum frequency 0x2915 (P210.00). • The brake closing threshold has a permanent hysteresis of 1 Hz in order to prevent an unwanted change-over. Exception: If the brake closing threshold is set to 0 Hz, the hysteresis is also 0 Hz. • In case of a setting of "0 Hz", only a start command is required to release the holding break during automatic operation.
0x2820:012 (P712.12)	Holding brake control: Closing threshold delay (Brake control: ClosingThr delay) 0 ... [0] ... 10000 ms <ul style="list-style-type: none"> • From version 03.00 	By setting a deceleration, a closing of the holding brake can be prevented if the frequency only temporarily falls below the brake closing threshold 0x2820:007 (P712.07) .

Additional functions

Holding brake control
Brake closing level



General mode of operation

The following diagram demonstrates the general functioning in automatic operation:

Input signals

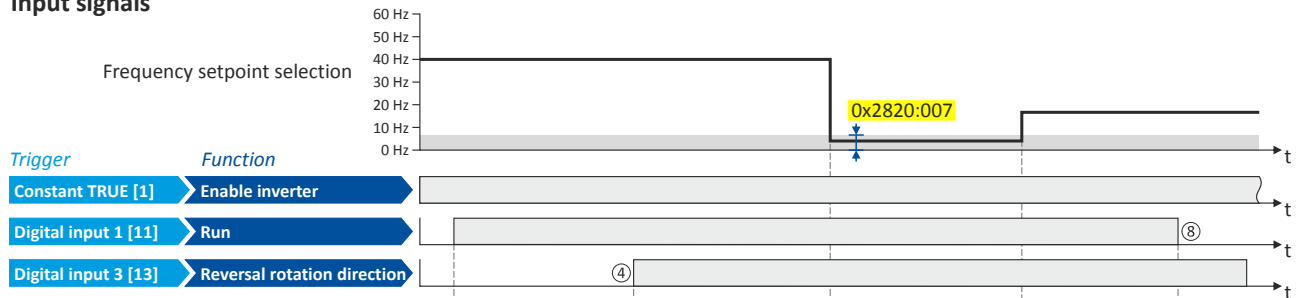

Output signals

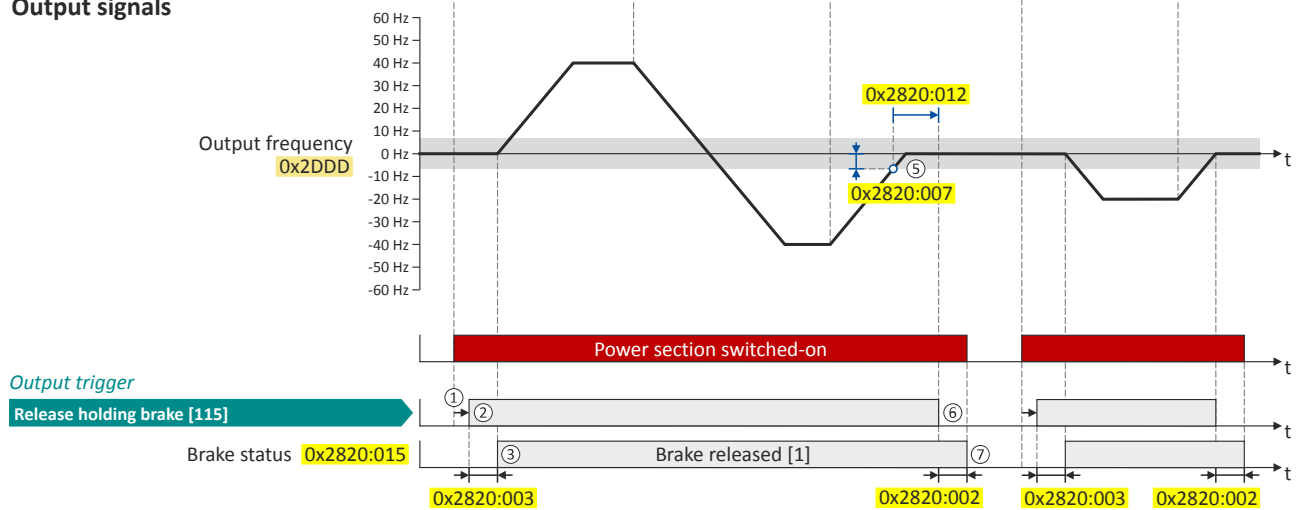

- ① If the inverter is enabled and no error is active, the motor can be started with the "Run" function in forward rotating direction. The power section is switched on and the motor is magnetised first.
- ② The holding brake is released. For this purpose, the output trigger "Release holding brake [115]" is set to TRUE. This trigger must be assigned to a digital output or, in the simplest case, to the relay which then switches the brake supply.
- ③ After the release time `0x2820:003` (P712.03) has elapsed, the motor is accelerated to the setpoint. The brake status "Brake released [1]" is displayed in `0x2820:015` (P712.15).
- ④ If the direction of rotation reverses, the holding brake remains released (even if the closing threshold delay is running.)
- ⑤ If the setpoint selection and the internal setpoint for the motor control fall below the brake closing threshold set in `0x2820:007` (P712.07), the output frequency is ramped down to "0 Hz". At the same time the closing threshold delay set in `0x2820:012` (P712.12) starts to run
- ⑥ If the values fall below the closing threshold longer than the closing threshold delay, the holding brake is closed again.
- ⑦ After the closing time `0x2820:002` (P712.02) has elapsed, the brake status "Active [0]" is displayed in `0x2820:015` (P712.15).
- ⑧ If "Run" is set to FALSE, the motor is stopped with the stop method set in `0x2838:003` (P203.03). In the example: Stop with standard ramp. In this case, closing threshold and closing threshold delay are not effective anymore.



10.11.5 Manual release of the holding brake

A manual release of the holding brake is possible in the modes "Automatic [0]" and "Manual [1]" via the following external triggers:

- Via bit 14 in the CiA 402 Controlword [0x6040](#).
- Via the trigger assigned in [0x2631:049 \(P400.49\)](#) of the "Release holding brake" function.
 - ▶ [Example for operating mode](#) [545](#)

Parameter	Name / value range / [default setting]	Info
0x2631:049 (P400.49)	Function list: Release holding brake (Function list: Release brake) <ul style="list-style-type: none"> • Setting can only be changed if the inverter is inhibited. • For further possible settings, see parameter 0x2631:001 (P400.01). 500 	Assignment of a trigger for the "Release holding brake" function. Trigger = TRUE: Release holding brake (immediately). Trigger = FALSE: no action. Notes: <ul style="list-style-type: none"> • Function is only executed if the brake mode 0x2820:001 (P712.01) is set to "Automatic [0]" or "Manual [1]". <p>⚠ CAUTION!</p> <ul style="list-style-type: none"> • The manually triggered "Release holding brake" command has a direct impact on the "Release holding brake [115]" trigger. Thus, the holding brake can be manually released if the power section is switched off! • The responsibility for a manual release of the holding brake has the external trigger source for the "Release holding brake" command!
	0 Not connected	No trigger assigned (trigger is constantly FALSE).
0x6040	CiA: Controlword 0 ... [0] ... 65535	Mappable CiA 402 control word with bit assignment according to device profile CiA 402.
	Bit 0 Switch on	1 = switch-on
	Bit 1 Enable voltage	1 = DC bus: Establish readiness for operation
	Bit 2 Quick stop	0 = activate quick stop
	Bit 3 Enable operation	1 = enable operation
	Bit 4 Operation mode specific	Bits are not supported.
	Bit 5 Operation mode specific	
	Bit 6 Operation mode specific	
	Bit 7 Fault reset	0-1 edge = reset error
	Bit 8 Halt (from version 04.00)	1 = stop motor (ramping down to frequency setpoint 0 Hz)
	Bit 9 Operation mode specific	Operating mode dependent
Bit 14 Release holding brake	1 = releasing holding brake manually ⚠ CAUTION! <ul style="list-style-type: none"> • The manually triggered "Release holding brake" command has a direct impact on the "Release holding brake [115]" trigger. Thus, the holding brake can be manually released if the power section is switched off. • The responsibility for a manual release of the holding brake has the external trigger source for the "Release holding brake" command. <p>▶ Holding brake control 429</p>	

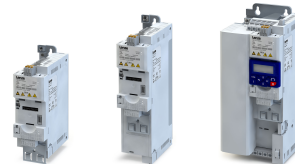

10.12 Flying restart circuit

The flying restart function makes it possible to restart a coasting motor on the fly during operation without speed feedback. Synchronicity between the inverter and the motor is coordinated so that the transition to the rotating drive is effected without jerk at the time of connection.



The following description and the listed parameters are valid for the flying restart circuit of an asynchronous motor.

For information on a flying restart circuit in case of a sensorless control of a synchronous motor, see chapter "[Sensorless control for synchronous motors \(SL-PSM\)](#)". [150](#)

Preconditions

- Drive systems with speed feedback do not need a flying restart circuit because there is always a jerk-free synchronisation to the feedback speed.
- The flying restart circuit operates safely and reliably in case of drives with high centrifugal masses. If several motors with different centrifugal masses are connected to the inverter, the flying restart circuit must not be used.
- The flying restart circuit serves to identify rotating field frequencies of up to maximally ± 200 Hz.
- Especially at high power, very high mass inertias and mains voltages higher than 440 V, a temporary overvoltage in the DC bus may occur. The use of a brake resistor can prevent this behaviour. [▶ Use of a brake resistor 393](#)

Required settings before the flying restart circuit is used:

1. The motor data must be set correctly. [▶ Motor data 137](#)
2. The settings for the current controller and the flying restart controller must be adapted to the motor. The settings are made automatically if one of the following optimisations is carried out:
 - [▶ Motor selection from motor catalogue 169](#)
 - [▶ Automatic motor identification \(energized\) 171](#)
 - [▶ Automatic motor calibration \(non-energized\) 172](#)

Details

The inverter determines synchronicity by identifying the synchronous rotating field frequency. The "search" starts in positive direction.

Duration:

- The flying restart process is determined within approx. 0.5 ... 1.5 seconds.
- The duration is influenced by the start frequency [0x2BA1:001 \(P718.01\)](#).

Setting the function:

1. As starting performance, set the selection "Flying restart circuit [2]" in [0x2838:001 \(P203.01\)](#).
 - Thus, every inverter enable causes a synchronisation to the rotating or standing drive.
 - After the inverter has been enabled, the motor can temporarily start or reverse if drives with low friction and low mass inertia are used.
 - If the inverter is operated with the default settings, no further settings are required for most applications.
2. If required, adapt the current [0x2BA1:001 \(P718.01\)](#) and the start frequency [0x2BA1:002 \(P718.02\)](#) for the flying restart circuit.
 - Setting notes can be found in the "Info" column for the respective parameter.

For diagnostic purposes, the frequency detected when the motor has been restarted on the fly is displayed in [0x2BA1:008 \(P718.08\)](#).



Additional functions

Flying restart circuit

Parameter	Name / value range / [default setting]	Info
0x2BA1:001 (P718.01)	Flying restart circuit: Current (Flying restart: Current) 0 ... [30] ... 100 %	<p>The current set here is injected into the motor during the flying restart process for the identification of the rotating field frequency.</p> <ul style="list-style-type: none"> • 100 % \equiv Motor rated current 0x6075 (P323.00) • Reducing the current causes a reduction of the motor torque during the flying restart process. A short-time starting action or reversing of the motor is prevented with low flying restart currents. • If the current is set too low, the rotating field frequency cannot be identified correctly. • If the current is increased, this improves the robustness of the flying restart circuit. • In case of high mass inertias and high speeds, the flying restart circuit may cause an overvoltage in the DC bus if no brake resistor is connected. In this case, the current must be reduced.
0x2BA1:002 (P718.02)	Flying restart circuit: Start frequency (Flying restart: Start frequency) -599.0 ... [20.0] ... 599.0 Hz	<p>The frequency set here defines the starting point for the flying restart process.</p> <ul style="list-style-type: none"> • The search starts in positive direction. • The default setting is adjusted to standard asynchronous motors. • In case of systems with a known search speed (e.g. torque-controlled drive systems that are to synchronise to a defined speed), the start frequency can be adapted for reducing the flying restart time.
0x2BA1:008 (P718.08)	Flying restart circuit: Flying restart frequency (Flying restart: Fl.res.frequency) • Read only: x.x Hz	<p>Display of the found frequency at which the motor has been successfully restarted on the fly.</p>

Additional functions

Timeout für fault reaction



10.13 Timeout für fault reaction

If an error occurs that does not immediately cause a switch-off, the "Fault reaction active" device status becomes initially active. The motor is brought to a standstill with quick stop ramp. The change to the device status "Fault" is only made after the quick stop (motor at standstill) has been executed or after an adjustable timeout time has expired.

Details

In the device status "Fault reaction active"

- only the parameters of the inverter can be changed that do not require an inverter disable.
- a holding brake in brake mode `0x2820:001 (P712.01)` = "Automatically (via device state) [0]" is triggered for closing.
- the motor control continues to be operable.

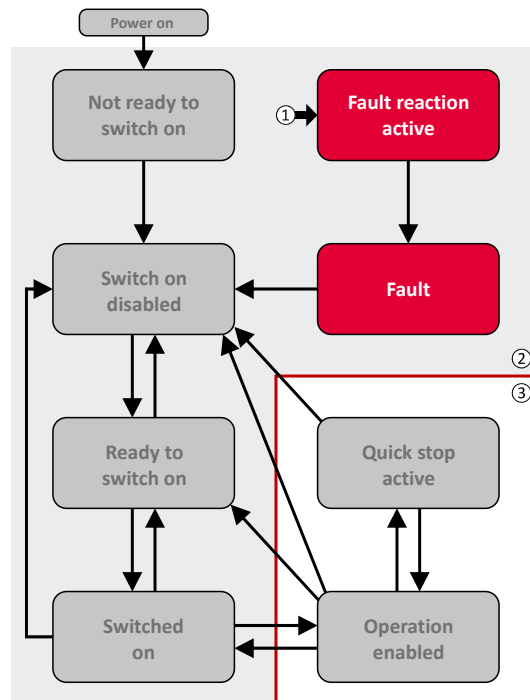

- ① From all states
- ② Power section inhibited (pulse inhibit)
- ③ Power section enabled

Diagnostic parameters:

- `0x282A:005 (P126.05)` displays the current device status of the inverter

Parameter	Name / value range / [default setting]	Info
0x2826	Time-out for error response 0.0 ... [6.0] ... 100.0 s	This timer is started when a change-over to the "Fault reaction active" device status takes place. If the motor is still rotating after the time-out time has elapsed, a change-over to the "Fault" device status takes place. <ul style="list-style-type: none"> • In case of a serious error, an immediate change-over to the "Fault" device status takes place. ⚠ CAUTION! Changing this parameter may cause a longer ramptime in the event of an error. This must be considered when changing this parameter.

Related topics

- ▶ [Error handling](#) 113
- ▶ [Automatic restart](#) 441



10.14 Automatic restart

Configuration of the restart behaviour after a fault.



The settings have no impact on errors and warnings of the inverter.

Parameter	Name / value range / [default setting]	Info
0x2839:002 (P760.02)	Fault configuration: Restart delay (Fault config.: Restart delay) 0.0 ... [3.0] ... 1000.0 s	If a fault occurs, a restart is possible at the earliest after the time set here has elapsed.
0x2839:003 (P760.03)	Fault configuration: Number of restart attempts (Fault config.: Restart counter) 0 ... [5] ... 255	Number of restart attempts after a fault. <ul style="list-style-type: none"> • 255 = unlimited number of restart attempts.
0x2839:004 (P760.04)	Fault configuration: Trouble counter reset time (Fault config.: Tro.count r.time) 0.1 ... [5.0] ... 3600.0 s	Time of trouble-free operation after the expiry of which the fault counter is decreased by 1.
0x2839:005 (P760.05)	Fault configuration: Trouble counter (Fault config.: Trouble counter) <ul style="list-style-type: none"> • Read only 	Display of the current fault counter content. <ul style="list-style-type: none"> • The counter content is increased by 1 after each restart attempt.

Related topics

▶ [Error handling](#) 113

▶ [Timeout für fault reaction](#) 440

Additional functions

Mains failure control



10.15 Mains failure control

In case of power failure, this function can decelerate the motor and use its rotational energy to maintain the DC-bus voltage for a certain period of time. This makes it possible to continue to let the motor run during a short-term failure of the mains voltage. After mains recovery, the operating status that was active before the failure is adopted again.

Details

A failure of the mains voltage causes a continuous DC-bus voltage drop. If the mains failure control is enabled in **0x2D66:001 (P721.01)**, it will get active if the DC-bus voltage falls below the activation threshold set in **0x2D66:002 (P721.02)**.

As soon as the mains failure control is active, the motor is decelerated. Now the rotational energy of the motor is used to maintain the DC-bus voltage above the error threshold for undervoltage until the motor is decelerated to standstill in a controlled way. This process is controlled by the DC-bus voltage controller.

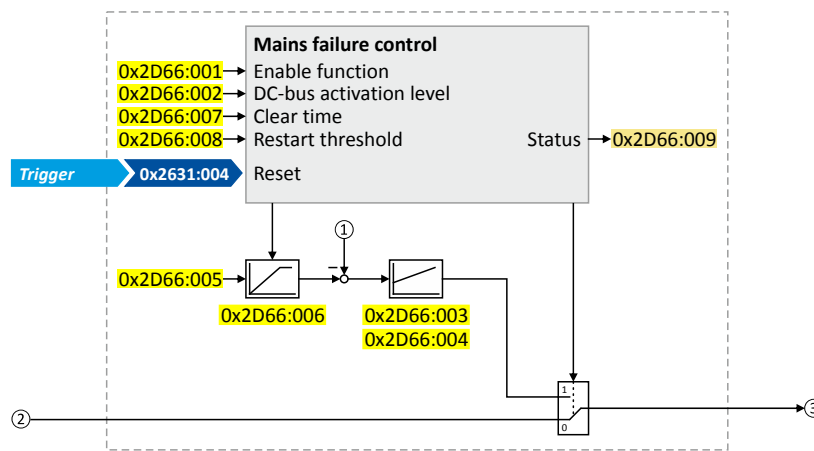

- ① Current DC-bus voltage
- ② Frequency setpoint (internal input signal)
- ③ Frequency setpoint (internal output signal for motor control)

The activation and commissioning of the mains failure control are described in detail in the following subchapters.

Parameter	Name / value range / [default setting]	Info
0x2D66:001 (P721.01)	Mains failure control: Enable function (Mains fail. ctrl: Enable function) • From version 02.00 0 Disabled 1 Enabled	1 = enable mains failure control.
0x2D66:002 (P721.02)	Mains failure control: DC-bus activation level (Mains fail. ctrl: DC-bus act.level) 60 ... [0]* ... 90 % * Default setting depending on the size. • From version 02.00	Threshold below which the mains failure control is activated if it is enabled (0x2D66:001 (P721.01) = 1). • 100 % ≙ nominal DC-bus voltage Recommended setting: • In general: 5 ... 10 % above the error threshold for undervoltage (display in 0x2540:003 (P208.03)). • 230-V devices: 72 % • 400/480-V devices: 82 %
0x2D66:003 (P721.03)	Mains failure control: Gain V-controller (Mains fail. ctrl: Gain V-ctrl) 0.00001 ... [0.01000] ... 0.50000 Hz/V • From version 02.00	Proportional gain of the DC-bus voltage controller.
0x2D66:004 (P721.04)	Mains failure control: Reset time V-controller (Mains fail. ctrl: Res. time V-ctrl) 5 ... [20] ... 2000 ms • From version 02.00	Reset time of the DC-bus voltage controller.



Additional functions

Mains failure control

Parameter	Name / value range / [default setting]	Info
0x2D66:005 (P721.05)	Mains failure control: DC voltage setpoint (Mains fail. ctrl: DC voltage setp.) 80 ... [100] ... 110 % • From version 02.00	Voltage setpoint onto which the DC-bus voltage is to maintained. • 100 % \equiv nominal DC-bus voltage
0x2D66:006 (P721.06)	Mains failure control: Setpoint ramp (Mains fail. ctrl: Setp. ramp) 1 ... [20] ... 16000 ms • From version 02.00	Acceleration time for the voltage setpoint set in 0x2D66:005 (P721.05) . • The set acceleration time refers to the acceleration from 0 to 100 % of the nominal DC-bus voltage.
0x2D66:007 (P721.07)	Mains failure control: Clear time (Mains fail. ctrl: Clear time) 1 ... [20] ... 60000 ms • From version 02.00	After the DC-bus voltage has exceeded the activation threshold 0x2D66:002 (P721.02) (+hysteresis) again, the time set here must be elapsed before the mains failure control is deactivated again if the restart protection is not activated (default setting).
0x2D66:008 (P721.08)	Mains failure control: Restart threshold (Mains fail. ctrl: Restart level) 0.0 ... [0.0] ... 599.0 Hz • From version 02.00	Threshold for restart protection. Below the threshold set here no restart takes place after mains recovery.
0x2D66:009 (P721.09)	Mains failure control: Status mains failure control (Mains fail. ctrl: RERT:Status) • Read only • From version 02.00	Bit coded display of the mains failure control status.
	Bit 0 Control active	1 \equiv mains failure control active. • The DC-bus voltage has fallen below the activation threshold 0x2D66:002 (P721.02) . • The bit is reset to 0 after the DC-bus voltage has exceeded the activation threshold (+hysteresis) again and the clear time set in 0x2D66:007 (P721.07) has elapsed.
	Bit 1 I-Reset active	1 \equiv I component of the speed controller of the motor control is reset. • Bit is set to 1 if bit 0 is set to 1 (mains failure control active). • Bit is reset to 0 if the frequency setpoint falls below 0.1 Hz.
0x2B01:002 (P303.02)	V/f shape data: Base frequency (V/f shape data: Base frequency) Device for 50-Hz mains: 0 ... [50]* ... 1500 Hz Device for 60-Hz mains: 0 ... [60]* ... 1500 Hz * Default setting depending on the size.	Base voltage and base frequency define the V/f ratio and thus the gradient of the V/f characteristic. • The V/f base voltage is usually set to the rated motor voltage 0x2C01:007 (P320.07) . • The V/f base frequency is usually set to the rated motor frequency 0x2C01:005 (P320.05) .

Additional functions

Mains failure control

Activating the mains failure control



10.15.1 Activating the mains failure control

1. Set the selection "Enabled [1]" in [0x2D66:001 \(P721.01\)](#).
2. Set the activation threshold in [%] with reference to the nominal DC-bus voltage in [0x2D66:002 \(P721.02\)](#).
 - Recommended setting: 5 ... 10 % above the error threshold for undervoltage (display in [0x2540:003 \(P208.03\)](#)).
3. Set the voltage setpoint onto which the DC-bus voltage is to be maintained in [0x2D66:005 \(P721.05\)](#).
 - Recommended setting: 95 ... 100 % (of the nominal DC-bus voltage).

The mains failure control gets active with these settings if the DC-bus voltage falls below the activation threshold. The DC-bus voltage controller now generates the required operational energy from the rotational energy of the motor. The motor is decelerated by the mains failure control. Thus, the deceleration ramp is shorter than the one of a non-guided system (coasting drive).

After the mains failure control has been activated:

1. The DC-bus voltage is controlled with the acceleration time set in [0x2D66:006 \(P721.06\)](#) to the setpoint set in [0x2D66:005 \(P721.05\)](#).
2. An internally generated frequency setpoint is transferred to the motor control which enables the motor (via the frequency setpoint) to be decelerated to a frequency close to "0 Hz".
 - Starting value for the guided deceleration is the current output frequency.
 - The deceleration ramp (and hence the braking torque) results from the moment of inertia of the load machine(s), the power loss of the drive (system) and the set parameterisation.

Behaviour after mains recovery

If, after mains recovery, the DC-bus voltage has exceeded the activation threshold (+hysteresis) again, an internal timing element is started. After the time period set in [0x2D66:007 \(P721.07\)](#) has elapsed, the mains failure control is stopped if the restart protection is not activated (default setting).

▶ [Restart protection](#)  445

▶ [Fast mains recovery](#)  445



10.15.2 Restart protection

The integrated restart protection is to prevent a restart in the lower frequency range if the mains voltage was only interrupted briefly (mains recovery before the motor stands still).

- In the default setting [0x2D66:008 \(P721.08\)](#) = 0 Hz, the restart protection is deactivated.
- In order to activate the restart protection, set the restart threshold in [Hz] in [0x2D66:008 \(P721.08\)](#) below which no automatic start shall take place after mains recovery.
- If, in case of mains recovery, the output frequency is below the restart threshold, the restart protection gets active:
 - If the current DC-bus voltage is lower than the voltage setpoint [0x2D66:005 \(P721.05\)](#), the motor is continued to be decelerated (until frequency 0 Hz).
 - If the current DC-bus voltage is higher than the voltage setpoint [0x2D66:005 \(P721.05\)](#), the motor is accelerated in a controlled way until the output frequency exceeds the restart threshold.
- If, in case of mains recovery, the output frequency is above the restart threshold, the motor is accelerated again to the frequency setpoint. ▶ [Fast mains recovery](#) 445

Diagnostic parameters:

- An active restart protection is displayed via the status bit 0 in [0x2D66:009 \(P721.09\)](#) if the mains failure control is not active.

Terminating the active restart protection

If, after mains recovery, the restart protection is active, it can be terminated by the following actions:

- Error reset via the trigger set in [0x2631:004 \(P400.04\)](#).
- Short-time inverter disable via the trigger set in [0x2631:001 \(P400.01\)](#).
- Restart via the trigger set in [0x2631:002 \(P400.02\)](#).

10.15.3 Fast mains recovery

A fast mains recovery is caused by a short interruption at the energy supply company (for instance due to a thunderstorm) and by faulty components in the supply cables (for instance slip rings).

The fast mains recovery causes a restart of the motor

- if the restart protection is deactivated ([0x2D66:008 \(P721.08\)](#) = 0 Hz, default setting)
or
- the restart protection does not get active (output frequency > [0x2D66:008 \(P721.08\)](#)).

If this behaviour is not desired, you can decelerate the restart by setting a switch-off time in [0x2D66:007 \(P721.07\)](#) or prevent it in connection with the restart protection. ▶ [Restart protection](#) 445

Additional functions

Mains failure control
Commissioning the mains failure control



10.15.4 Commissioning the mains failure control

Commissioning should be executed with motors without load:

1. Let the motor rotate with a rated frequency of 100 %.
2. Disable the inverter and measure the time until the motor has reached standstill.
 - The time can be measured with a stop watch or similar.
 - If a motor encoder is connected to the inverter and set as feedback system for the motor control, this signal can be output at the analog output and measured with an oscilloscope.
3. Set the acceleration time for the voltage setpoint in [0x2D66:006 \(P721.06\)](#) to approx. 1/10 of the time measured before.
4. Set the switch-off time in [0x2D66:007 \(P721.07\)](#) to the time measured before.

Fine adjustment of the mains failure control

For the fine adjustment, you must repeat the following points several times:

1. An end frequency as low as possible should be reached before the inverter reaches the error threshold for undervoltage:
 - Increase the proportional gain of the DC-bus voltage controller in [0x2D66:003 \(P721.03\)](#).
 - Reduce the reset time of the DC-bus voltage controller in [0x2D66:004 \(P721.04\)](#).
2. If, during the mains failure control, monitoring for overvoltage in the DC bus is triggered:
 - Increase the reset time again in [0x2D66:004 \(P721.04\)](#) until monitoring is not triggered anymore.
 - If required, additionally reduce the voltage setpoint in [0x2D66:005 \(P721.05\)](#) onto which the DC-bus voltage is to be controlled.
3. Increasing the delay time or reducing the braking torque is only possible to a limited extent:
 - Increasing the acceleration time in [0x2D66:006 \(P721.06\)](#) reduces the initial braking torque and simultaneously increases the deceleration time.
 - Increasing the reset time of the DC-bus voltage controller in [0x2D66:004 \(P721.04\)](#) reduces the braking torque and simultaneously increases the deceleration time. If the reset time is too high, the inverter reaches the error threshold for undervoltage before standstill is reached. From this point on, the motor is not guided anymore.

Signal flow - DC-bus voltage controller

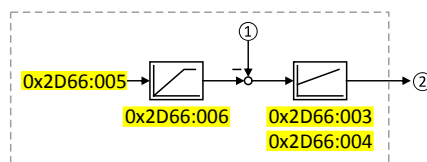

① Current DC-bus voltage

② Internally generated frequency setpoint that is transferred to the motor control in case of an active mains failure control.



10.16 Process data

This chapter describes additional functions that provide process data for a higher-level Controller.

10.16.1 Position counter

This function counts the number of motor revolutions. The current counter content (actual position) can be output as process data via network to implement a simple position control in a higher-level Controller.

Preconditions

- An HTL encoder must be connected to and set at the digital inputs DI3/DI4. ▶ [HTL encoder](#) [450](#)
- As an alternative, the number of motor revolutions from the motor model can be reconstructed. For this purpose, the motor control type "Sensorless control (SL PSM) [3]" must be selected and set in [0x2C00 \(P300.00\)](#). ▶ [Sensorless control for synchronous motors \(SL-PSM\)](#) [150](#)
- The position control must be implemented in the Controller.

Details

The signal source for the position counter is selected in [0x2C49:001 \(P711.01\)](#). The position counter can count forwards and backwards. The current counter content (actual position) is displayed in [0x2C49:003 \(P711.03\)](#). After the maximum or minimum value has been reached, an overflow takes place.

Reset position counter:

- The position counter is reset when the supply voltage is switched on.
- The position counter can be set manually via the "Position counter reset" [0x2631:054 \(P400.54\)](#) function or the NetWordIN1 [0x4008:001 \(P590.01\)](#) data word. For a reset via NetWordIN1, the "Position counter reset [54]" function must be assigned to a bit of the data word. Depending on the selection in [0x2C49:002 \(P711.02\)](#), the reset can be made either edge-controlled or status-controlled.

Parameter	Name / value range / [default setting]	Info
0x2631:054 (P400.54)	Function list: Position counter reset (Function list: PosCounter reset) <ul style="list-style-type: none"> • From version 03.00 • For further possible settings, see parameter 0x2631:001 (P400.01). 500 	Assignment of a trigger for the "Position counter reset" function. Trigger = FALSE-TRUE edge: Reset position counter manually. Trigger = FALSE: no action. Notes: <ul style="list-style-type: none"> • In 0x2C49:002 (P711.02) it can be selected whether the reset is to be effected edge-controlled (default setting) or status-controlled.
	0 Not connected	No trigger assigned (trigger is constantly FALSE).
0x2C49:001 (P711.01)	Position counter: Signal source (Position counter: Signal source) <ul style="list-style-type: none"> • From version 03.00 	Selection of the signal source for the position counter.
	0 Disabled	Position counter is deactivated.
	1 Feedback 1 (DI3/DI4)	The motor revolutions are counted that are provided by an HTL encoder connected to the digital inputs DI3/DI4. <ul style="list-style-type: none"> • A motor revolution always equals to the increments/revolution set in 0x2C42:001 (P341.01) for the HTL encoder. This applies to all types of HTL encoders that can be set in 0x2630:002 (P410.02): "HTL encoder (AB) [1]", "Pulse train [2]" and "Pulse train/direction [3]". • The counter content will be updated as well if the power section is switched off. • If an HTL encoder is used without detecting the direction of rotation, it is only counted forwards.
5 Internal motor model	The motor revolutions reconstructed from the internal motor model of the sensorless control (SL PSM) are counted. <ul style="list-style-type: none"> • The counter content will not be updated if the power section is switched off. • After restarting the power section, the counting of the last counter content is continued. 	

Additional functions

Process data

Position counter



Parameter	Name / value range / [default setting]	Info
0x2C49:002 (P711.02)	Position counter: Reset mode (Position counter: Reset mode) <ul style="list-style-type: none">• From version 03.00	Selection if the manual reset of the position counter is to be effected edge-controlled or status-controlled.
	0 Reset by rising edge	
	1 Reset by signal state true	
0x2C49:003 (P711.03)	Position counter: Actual position (Position counter: Actual position) <ul style="list-style-type: none">• Read only• From version 03.00	Mappable parameter for providing the current counter content (actual position) via network. Scaling (applies to every measuring method or encoder resolution): <ul style="list-style-type: none">• Upper 16 bits: Counted revolutions (0 ... 65535, overflow possible)• Lower 16 bits: Current position within the revolution (0 ... 65535)

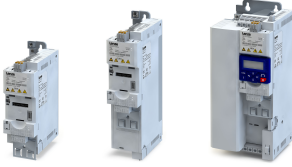

10.17 Encoder settings

In general, an encoder is a measuring system which serves to detect the velocity/speed and possibly the position of a kinematics or motor.

- The Inverter i550 exclusively supports HTL encoders.
- For details see the following subchapter.

Additional functions

Encoder settings
HTL encoder



10.17.1 HTL encoder

In case of the inverter i550, the digital inputs DI3 and DI4 can be configured as HTL input to evaluate the signal of a cost-effective HTL encoder or a reference frequency ("pulse train").

An HTL encoder can be used at the Inverter i550 for the following tasks:

- As motor encoder for a motor speed feedback for speed control as precise as possible.
- As setpoint encoder for defining a frequency setpoint.
- As setpoint encoder for defining the reference value for the process controller.
- As setpoint encoder for defining a torque setpoint.
- As actual value encoder for the process controller.
- As actual value encoder for the "position counter" function.

Preconditions

- Single-track or two-track HTL encoder.
 - A single-track HTL encoder (track A) cannot be used for motor speed feedback.
 - A two-track HTL encoder (track A and B) must have a phase offset of exactly 90° between track A and B (error $\leq \pm 10^\circ$). Inverted tracks are not required.
- Encoder increments: ≤ 16384 increments per revolution
- For supplying the encoder, the maximum supply current of the inverter must be considered. If necessary, an external 24-V voltage supply for the encoder is required.

Restrictions

- When the digital inputs DI3 and DI4 are configured as HTL input, these two digital inputs are no longer available for other control functions.
- The HTL input can be either used for detecting an HTL encoder signal or a pulse train. They cannot be used at the same time.
- The maximum input frequency of the digital inputs is 100 kHz. If this frequency is exceeded, an error is triggered.

Connection

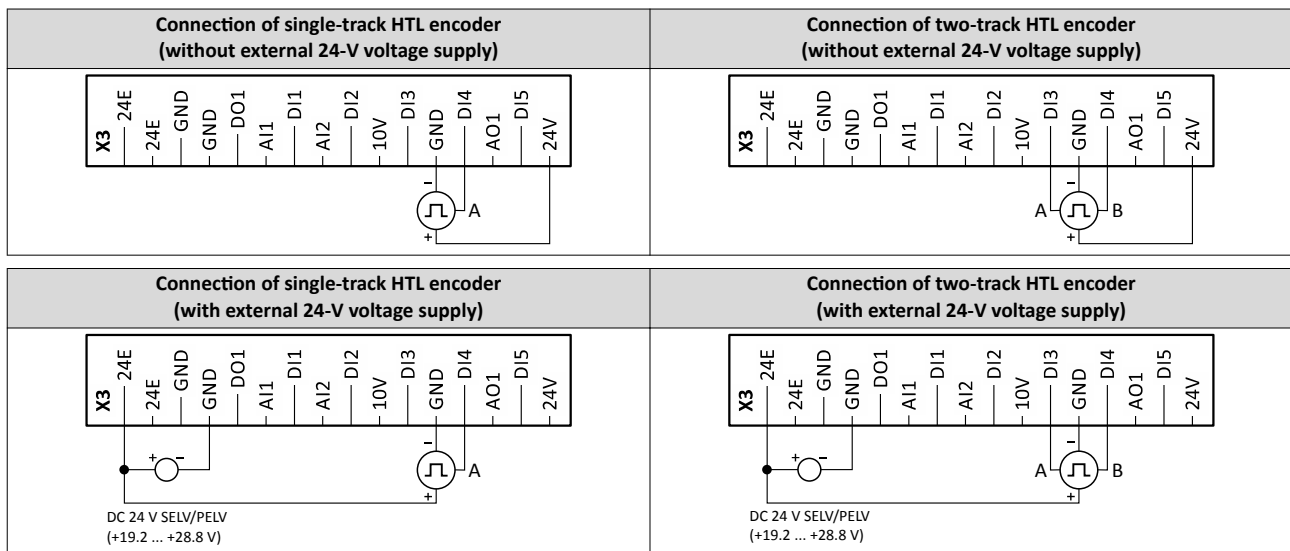

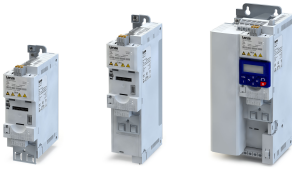

Details

Encoder dimensioning: Calculate maximum number of increments per revolution of the encoder	
Max. encoder increments = $f_{\max} [\text{Hz}] * 60 \text{ s} / n_{\max} [\text{rpm}]$	
Max. encoder increment = $100000 [\text{Hz}] * 60 \text{ s} / 1500 [\text{rpm}] = 4000 \text{ Increments/revolution}$	
f_{\max}	Maximum input frequency of the digital inputs = 100 kHz = 100000 Hz
n_{\max}	Maximum encoder speed (in this example: 1500 rpm)
Max. encoder increments	Maximum number of increments per encoder revolution



Select an encoder with a maximum number of increments per revolution which is lower than or equal to the calculated number. The higher the number of increments per revolution, the more stable the system is.

Basic steps for configuring the encoder in the »EASY Starter«:

1. Set the selection "HTL encoder (AB) [1]" in [0x2630:002 \(P410.02\)](#) to configure the digital inputs DI3 and DI4 as encoder inputs.
2. Set the encoder increment in [0x2C42:001 \(P341.01\)](#) according to the manufacturer data/encoder data sheet.

Parameter	Name / value range / [default setting]	Info
0x2C42:001 (P341.01)	Encoder settings: Increments/revolution (Encoder settings: Enc. Inc/Rev) 1 ... [128] ... 16384 • Setting can only be changed if the inverter is inhibited. • From version 02.00	Encoder increment. Carry out setting according to manufacturer data/encoder data sheet.
0x2C42:006	Encoder settings: Actual velocity • Read only: x rpm • From version 02.00	Display of the speed currently detected by the encoder.
0x2630:002 (P410.02)	Settings for digital inputs: Input function (DI settings: Input function)	Input function of the digital terminals DI3 and DI4.
	0 Digital input	DI3 = digital input DI4 = digital input
	1 HTL encoder (AB) (from version 02.00)	DI3 = HTL input for encoder track B DI4 = HTL input for encoder track A
	2 Pulse train (from version 03.00)	DI3 = digital input DI4 = HTL input for pulse train
3 Pulse train/direction (from version 03.00)	DI3 = HTL input for direction specification; HIGH level = counter-clockwise (CCW) DI4 = HTL input for pulse train	

Related topics

- ▶ [Selection of setpoint source](#) [122](#)
- ▶ [Position counter](#) [447](#)
- ▶ [HTL input setpoint source](#) [534](#)

Additional functions

Encoder settings
Encoder monitoring



10.17.2 Encoder monitoring

For monitoring the HTL encoder, two monitoring functions are implemented in the inverter firmware:

- a) Encoder signal loss monitoring: Is triggered if a failure of the encoder signal is detected (e. g. due to open circuit or failure of the encoder current supply).
- b) Encoder maximum frequency monitoring: Is triggered if the calculated encoder maximum frequency is beyond the permissible frequency range of the digital inputs.

Preconditions

- The encoder signal loss monitoring is only active if the HTL encoder
 - is set as feedback system for the motor control or
 - used as signal source for the "[Position counter](#)" function. [447](#)
- For the encoder signal loss monitoring, the inverter must be enabled and the motor must rotate.
- The encoder maximum frequency monitoring is active as soon as the HTL encoder has been configured.

Restrictions

- The encoder signal loss monitoring does not work anymore if the "[DC braking](#)" function is active. [386](#)
- The response time of the encoder signal loss monitoring depends on the setting of the encoder increments/revolution in [0x2C42:001 \(P341.01\)](#).
- The settings of the speed controller can influence the encoder signal loss monitoring. If the reset time of the speed controller is very low or deactivated, an encoder signal loss cannot be detected at switch-on.
- If the HTL encoder is used as signal source for the "[Position counter](#)" function, an encoder signal loss cannot be detected at switch-on.
- Combined with the "[Holding brake control](#)" function:
 - In order that the encoder signal loss monitoring is not triggered by mistake, monitoring will only be activated when the holding brake is released.
 - If Brake closing time [0x2820:002 \(P712.02\)](#) and Brake opening time [0x2820:003 \(P712.03\)](#) are not set correctly, the encoder signal loss monitoring can be triggered although an encoder signal is available.

▶ [Holding brake control](#) [429](#)



Details on encoder signal loss monitoring

The encoder signal loss monitoring distinguishes between the following signal failures:

- Complete failure (no encoder signals available at all, e. g. in case the encoder current supply has failed)
- Only one track has failed (track A or track B)

In order to detect a complete failure, the inverter calculates internally two trigger thresholds for monitoring based on the configuration of the HTL encoder:

- Based on the encoder resolution set in [0x2C42:001 \(P341.01\)](#), the minimum output frequency is calculated:

$$\text{Minimum output frequency [Hz]} = \frac{\text{number of motor pole pairs}}{t_{\text{max}} [\text{s}] \cdot \frac{\text{encoder increments}}{\text{revolution}}} = \frac{\text{number of motor pole pairs}}{0.001 [\text{s}] \cdot 4 \cdot \frac{\text{encoder increments}}{\text{revolution}}}$$

Note: The maximum time (t_{max}) per edge is 0.001 s. In order to prevent a false tripping, this value is multiplied by the factor 4.

Calculation example:

- Number of pole pairs = 2
- Encoder resolution = 128 increments/revolution

$$\text{minimum output frequency [Hz]} = \frac{2}{0.001 [\text{s}] \cdot 4 \cdot 128} = 3.9 [\text{Hz}]$$

- The maximum permitted time is calculated in which a new signal edge of the encoder must arrive:

$$\text{time per edge [s]} = \frac{1}{\text{encoder frequency [Hz]} \cdot \frac{\text{encoder increments}}{\text{revolution}}}$$

If the calculation with the (synchronous) encoder frequency at minimum output frequency (here: $2 \cdot 3.9$ Hz) is carried out, the resulting time interval equals the maximum time per edge (here: 0.001 s)

If the real encoder frequency is lower than the calculated minimum output frequency AND if the new signal edge has not arrived within the maximum permitted item, monitoring is triggered. The complete failure is displayed via the status bit 4 in [0x2C42:007](#).

If only track A or B fails, signals are continued to be detected. In this case, however, the sign of the frequency changes with every new signal edge. In order to detect the failure of only one track, an internal counter is increased by 1 every time the sign between two signal edges changes. If the sign is unchanged in two signal edges in a row, the counter is reset. If the counter reaches the counter content "100", monitoring is triggered. The failure of only one track is displayed via the status bit 5 in [0x2C42:007](#).

Both in case of a complete failure and in case only one track fails, the error message "Encoder open circuit" (error code [29445](#) | [0x7305](#)) is output. The error response can be selected in [0x2C45 \(P342.00\)](#).

Additional functions

Encoder settings
Encoder monitoring



Details on encoder maximum frequency monitoring

After the HTL encoder has been configured (or if the encoder settings are changed), the inverter internally calculates the maximum possible number of encoder pulses per second (herein-after referred to as "encoder maximum frequency"):

$$\text{encoder maximum frequency [Hz]} = \frac{\text{encoder increments}}{\text{revolution}} \cdot \frac{\text{max. motor speed [rpm]}}{60}$$

If the calculated encoder maximum frequency is beyond the permissible frequency range of the digital inputs, monitoring is triggered:

- The status bit 0 in [0x2C42:007](#) is set to "1".
- The warning "Feedback system: speed limit" (error code [29573](#) | [0x7385](#)) is output.

Calculation example 1:

- Maximum input frequency of the digital inputs = 100 kHz
- Encoder resolution [0x2C42:001 \(P341.01\)](#) = 1024 increments/revolution
- Max motor speed [0x6080 \(P322.00\)](#) = 3000 rpm

$$\text{encoder maximum frequency [Hz]} = 1024 \frac{\text{encoder increments}}{\text{revolution}} \cdot \frac{3000 \text{ [rpm]}}{60} = 51200 \text{ [Hz]}$$

Result: The encoder maximum frequency monitoring is not triggered because the encoder maximum frequency is within the permissible frequency range of the digital inputs.

Calculation example 2:

- Maximum input frequency of the digital inputs = 100 kHz
- Encoder resolution [0x2C42:001 \(P341.01\)](#) = 4096 increments/revolution
- Max motor speed [0x6080 \(P322.00\)](#) = 3600 rpm

$$\text{encoder maximum frequency [Hz]} = 4096 \frac{\text{encoder increments}}{\text{revolution}} \cdot \frac{3600 \text{ [rpm]}}{60} = 245760 \text{ [Hz]}$$

Result: The encoder maximum frequency monitoring is triggered because the encoder maximum frequency is beyond the permissible frequency range of the digital inputs.

Parameter	Name / value range / [default setting]	Info
0x2C42:007	Encoder settings: Status 0 ... [0] ... 4294967295 • From version 02.00	Bit coded display of the status of encoder monitoring.
	Bit 0 Maximum encoder speed reached	1 ≡ the calculated encoder maximum frequency is beyond the permissible frequency range of the digital inputs.
	Bit 4 No signal detected	1 ≡ a complete failure of the encoder signals has been detected.
	Bit 5 Encoder track A or B missing	1 ≡ a failure of only one track (track A or track B) has been detected.
0x2C45 (P342.00)	Encoder-error response (Enc.error resp.) • From version 03.00	Selection of the response to the triggering of the encoder signal loss monitoring. Associated error code: • 29445 0x7305 - Encoder open circuit
	0 No response	▶ Error types 113
	1 Warning	
	3 Fault	
0x2C42:001 (P341.01)	Encoder settings: Increments/revolution (Encoder settings: Enc. Inc/Rev) 1 ... [128] ... 16384 • Setting can only be changed if the inverter is inhibited. • From version 02.00	Encoder increment. Carry out setting according to manufacturer data/encoder data sheet.
0x2C42:006	Encoder settings: Actual velocity • Read only: x rpm • From version 02.00	Display of the speed currently detected by the encoder.



10.18 Firmware download

The device firmware is continuously improved by the manufacturer. New firmware versions contain error corrections, function extensions and simplify the handling.

A new firmware is always compatible with the older version:

- A device with updated firmware and unchanged parameter settings shows the same behaviour as before.
- Parameter settings must only be adapted if new functions are used.

10.18.1 Firmware download via EtherCAT

The inverter i550 supports the automatic firmware download via EtherCAT. The main reason for an automatic firmware download is the simultaneous update of firmware and parameter settings for an already finished machine.

Typical applications for an automatic firmware download:

- Series production: All machines automatically receive the firmware released for the machine including parameter settings.
- Device replacement: If a device replacement is required, the device automatically gets the suitable firmware including parameter settings without the need for an intervention or special knowledge of the machine operator.
- Device update: Due to function extensions or error corrections, an update of the firmware is almost automatically possible for the machine manufacturer or end user.

Preconditions

- The control electronics of the inverter must be supplied with voltage.
- Voltage supply and communication must not be interrupted during the firmware download.
- For the firmware download, the inverter must be in the "Bootstrap" EtherCAT communication status.

Details

For the automatic firmware download via EtherCAT, the "File over EtherCAT (FoE)" service is used. Only one firmware called "ix00.bin" is accepted. If the connection is interrupted during the firmware download, the device starts with the old firmware.

Additional functions

Firmware download

Firmware download with »EASY Starter (Firmware loader)«

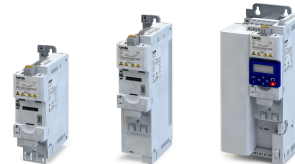

10.18.2 Firmware download with »EASY Starter (Firmware loader)«

The »EASY Starter (firmware loader)« is a PC software which serves to update the firmware of the inverter.

Preconditions

- For the firmware download, we recommend a direct USB connection to the device. For this purpose, the USB module and a USB 2.0 cable (A plug on Micro-B plug) are required. The voltage supply of the control electronics also takes place via the USB connection.
- The control electronics of the inverter must be supplied with voltage. Either via the USB connection or via the external 24-V voltage supply.
- Voltage supply and communication must not be interrupted during the firmware download.

Details

Together with the »EASY Starter« engineering tool, the following tools are installed as well:

Tool	Brief description
»EASY Navigator«	Helps you to find the right tool for your application.
»EASY Package Manager«	Enables the automatic download and the installation of files for the engineering tools. <ul style="list-style-type: none">• For this purpose, the »EASY Package Manager« is provided with current files by the manufacturer and enables the user to install them.• The files also include new firmware versions for inverters.
»EASY Starter (firmware loader)«	Enables the update of the firmware for inverters. <ul style="list-style-type: none">• The update can be made by the mechanical engineer or the end user depending on the access protection set for the device.

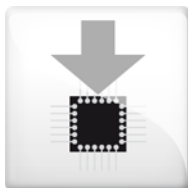

Carry out the firmware download with the »EASY Starter (firmware loader)«:

1. Start »EASY Navigator« (All programs → Lenze → EASY Navigator).
2. In the »EASY Navigator«, change to the "Ensuring productivity" engineering phase.
3. Click the »EASY Starter (firmware loader)« icon (see on the left).
4. Follow the instructions of the »EASY Starter (firmware loader)«.

Notes:

- The firmware download will not take more than 20 seconds. The progress is shown in the »EASY Starter (firmware loader)«.
- After the firmware download, the connection to the device gets lost for some second and is then restored again automatically.
- Device settings are not changed by the firmware download.
- The brand protection does not get lost by the firmware download.
- The firmware can neither be exported from the device nor be deleted from the device.

If the connection is aborted during the firmware download, this may have the following consequences:

- The device starts with the old firmware. The firmware download can be restarted.
- The firmware in the device is damaged. Contact the Lenze Service.



Additional functions

Additive voltage impression
Firmware download with »EASY Starter (Firmware loader)«

10.19 Additive voltage impression

This function serves to boost (or lower) the motor voltage from the process via an additive voltage setpoint in order to realise a load adjustment (for instance in case of winder applications).

i NOTICE

A too high boost of the motor voltage may cause the motor to heat up strongly due to the resulting current.

► Avoid a too high boost of the motor voltage!

Details

At a constant field frequency, the output voltage of the inverter can be changed within a wide range.

Example: Adaptation of the voltage characteristic in case of V/f characteristic control as a function of the load:

- Clockwise rotation (CW) is operation in motor mode: Boost voltage.
- Counter-clockwise rotation (CCW) is operation in generator mode: Lower voltage.

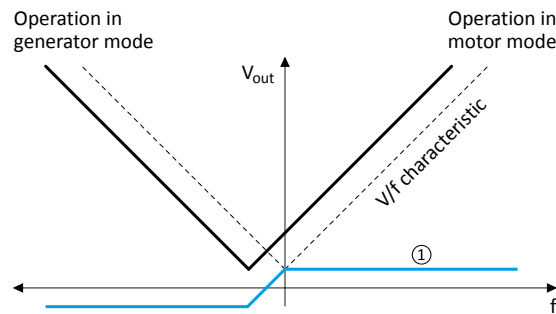

① Selecting an additive voltage setpoint

A detailed configuration example for this function can be found in the following subchapter.

Parameter	Name / value range / [default setting]	Info
0x2B13:001	Additive voltage impression: Enable Function • From version 02.00	1 = enable function.
	0 Disable 1 Enable	
0x2B13:002	Additive voltage impression: Setpoint source • From version 02.00	Selection of the source for specifying the additive voltage setpoint. • 100 % \equiv Rated voltage 0x2C01:007 (P320.07)
	1 Analog input 1 2 Analog input 2	
0x2B13:003	Additive voltage impression: Actual voltage • Read only: x V • From version 02.00	Display of the current (boosted or lowered) voltage.

Additional functions

Additive voltage impression

Example: Using the function with a 400-V inverter

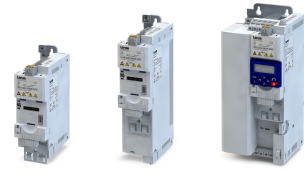

10.19.1 Example: Using the function with a 400-V inverter

With the settings indicated below, the motor is accelerated after the start to 50 Hz. As the base frequency, however, is set very high (here: 599 Hz), the motor voltage at 50 Hz only amounts to 20 VAC.

Now, the analog input 1 serves to change the motor voltage at constant frequency within a wide range:

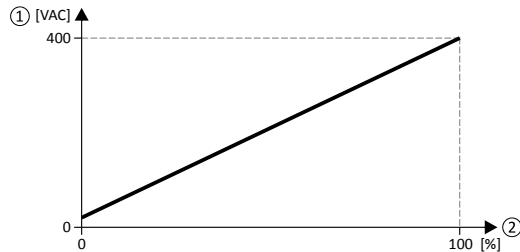

- ① Motor voltage
- ② Selection of an additive voltage setpoint in percent via analog input 1

Parameter	Name	Setting for this example
0x2636:004 (P430.04)	Min PID value	0 %
0x2636:005 (P430.05)	Max PID value	100 %
0x2860:001 (P201.01)	Frequency control: Default setpoint source	Frequency preset 1 [11]
0x2911:001 (P450.01)	Frequency setpoint presets: Preset 1	50 Hz
0x2B01:002 (P303.02)	Base frequency	599 Hz
0x2B13:001	Enable Function	Enable [1]
0x2B13:002	Setpoint source	Analog input 1 [1]



10.20 Parameter for engineering tools

The following parameters are required for an interaction of the engineering tools with the inverter connected online. They are not relevant for the user and only reported here for the sake of completeness.

Parameter	Name / value range / [default setting]	Info
0x2022:032	Device commands: Deactivate PDO Communication <ul style="list-style-type: none"> From version 03.00 For further possible settings, see parameter 0x2022:001 (P700.01). 366 	Parameters for interaction with engineering tools.
	0 Off / ready	
0x2022:033	Device commands: Activate PDO Communication <ul style="list-style-type: none"> For further possible settings, see parameter 0x2022:001 (P700.01). 366 	Parameters for interaction with engineering tools.
	0 Off / ready	
0x2822:001	Enable inverter	Parameters for interaction with engineering tools.
	0 Inverter inhibited 1 Inverter enabled	
0x2822:002	Activate quick stop 0 ... [0] ... 1	
0x2822:003	Reset error 0 ... [0] ... 1	
0x2822:028	Initialize device controller 0 ... [0] ... 1	
0x2823:001	Last subindex <ul style="list-style-type: none"> Read only 	
0x2823:002	Status of last axis command <ul style="list-style-type: none"> Read only 	
	0 Successful	
	1 Unknown command	
	2 No access	
	3 Time-out	
	4 Error	
	5 Command server assigned	
	6 Disable inverter required	
	7 Enable inverter required	
	8 Command is executed	
	10 Memory module link invalid	
	11 Password too short	
	12 Wrong password	
	13 Password set	
	14 Password assigned	
	15 Command aborted	
0x2832	Motor identification status <ul style="list-style-type: none"> Read only From version 02.00 	
	Bit 0 Identification enabled	
	Bit 1 Identification active	
	Bit 2 Identification completed	
	Bit 3 Identification failed	

Additional functions

Parameter for engineering tools



Parameter	Name / value range / [default setting]	Info	
0x2DB8:001	Function list status word 1		
	• Read only		
	• From version 04.00		
	Bit 0	Enable inverter	
	Bit 1	Run	
	Bit 2	Activate quick stop	
	Bit 3	Reset fault	
	Bit 4	Activate DC braking	
	Bit 5	Start forward (CW)	
	Bit 6	Start reverse (CCW)	
	Bit 7	Run forward (CW)	
	Bit 8	Run reverse (CCW)	
	Bit 9	Jog forward (CW)	
	Bit 10	Jog reverse (CCW)	
	Bit 11	Activate keypad control	
	Bit 12	Invert rotation	
	Bit 13	Activate AI1 setpoint	
	Bit 14	Activate AI2 setpoint	
	Bit 15	Activate keypad setpoint	
	Bit 16	Activate network setpoint	
	Bit 17	Activate preset (bit 0)	
	Bit 18	Activate preset (bit 1)	
	Bit 19	Activate preset (bit 2)	
	Bit 20	Activate preset (bit 3)	
	Bit 21	Activate setpoint via HTL input	
	Bit 22	MOP setpoint up	
	Bit 23	MOP setpoint down	
	Bit 24	Activate MOP setpoint	
	Bit 25	Activate segment 1 setpoint	
	Bit 26	Activate segment 2 setpoint	
	Bit 27	Activate segment 3 setpoint	
	Bit 28	Activate segment 4 setpoint	
Bit 29	Activate sequencer setpoint		
Bit 30	Start sequencer		
Bit 31	Next sequence step		



Parameter	Name / value range / [default setting]	Info
0x2DB8:002	Function list status word 2	
	<ul style="list-style-type: none"> • Read only • From version 04.00 	
	Bit 0 Pause sequence	
	Bit 1 Suspend sequence	
	Bit 2 Stop sequence	
	Bit 3 Abort sequence	
	Bit 4 Activate network control	
	Bit 5 Deactivate network control	
	Bit 6 Activate ramp 2	
	Bit 7 Load parameter set	
	Bit 8 Select parameter set (bit 0)	
	Bit 9 Select parameter set (bit 1)	
	Bit 10 Activate fault 1	
	Bit 11 Activate fault 2	
	Bit 12 Deactivate PID controlling	
	Bit 13 Set PID output to 0	
	Bit 14 Inhibit PID I-component	
	Bit 15 Activate PID influence ramp	
	Bit 16 Release holding brake	
	Bit 17 Select sequence (bit 0)	
	Bit 18 Select sequence (bit 1)	
	Bit 19 Select sequence (bit 2)	
	Bit 20 Select sequence (bit 3)	
	Bit 21 Reset position counter	
	Bit 22 Reserved	
	Bit 23 Reserved	
	Bit 24 Reserved	
	Bit 25 Reserved	
	Bit 26 Reserved	
	Bit 27 Reserved	
	Bit 28 Reserved	
	Bit 29 Reserved	
Bit 30 Reserved		
Bit 31 Reserved		
0x2DD3:001	Speed setpoint	
	<ul style="list-style-type: none"> • Read only: x rpm • From version 03.00 	
0x2EFF:001	Bootloader activation key 1	
	0 ... [0] ... 4294967295	
	<ul style="list-style-type: none"> • Setting can only be changed if the inverter is inhibited. 	
0x2EFF:002	Bootloader activation key 2	
	0 ... [0] ... 4294967295	
	<ul style="list-style-type: none"> • Setting can only be changed if the inverter is inhibited. 	
0x2EFF:003	Bootloader activation key 3	
	0 ... [0] ... 4294967295	
	<ul style="list-style-type: none"> • Setting can only be changed if the inverter is inhibited. 	

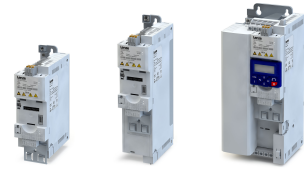

11 Sequencer

The "sequencer" function serves to transfer a programmed sequence of setpoints to the motor control. The switch-over to the next setpoint can be made time-controlled or even-controlled. Optionally, the "sequencer" function can also trigger the digital and analog outputs.



The sequencer only generates setpoints. However, the sequencer does not control the motor operation (does not output any start and stop commands).

Basics: Sequences, steps and segments

- As a total, 8 sequences can be configured (with the numbers 1 to 8).
- Each sequence consists of 16 configurable steps.
- Each step of a sequence can call a "segment".
 - A segment contains, among other things preset setpoints (speed setpoint, PID control value, torque setpoint), a combined acceleration/deceleration for the speed setpoint and optionally a configuration for the digital and analog outputs.
 - 8 different segments and one end segment can be configured.
- Alternatively to calling a single segment, a complete sequence (with a higher number) can also be called from one step. This serves to implement nested sequences or summarise several sequences to one sequence.

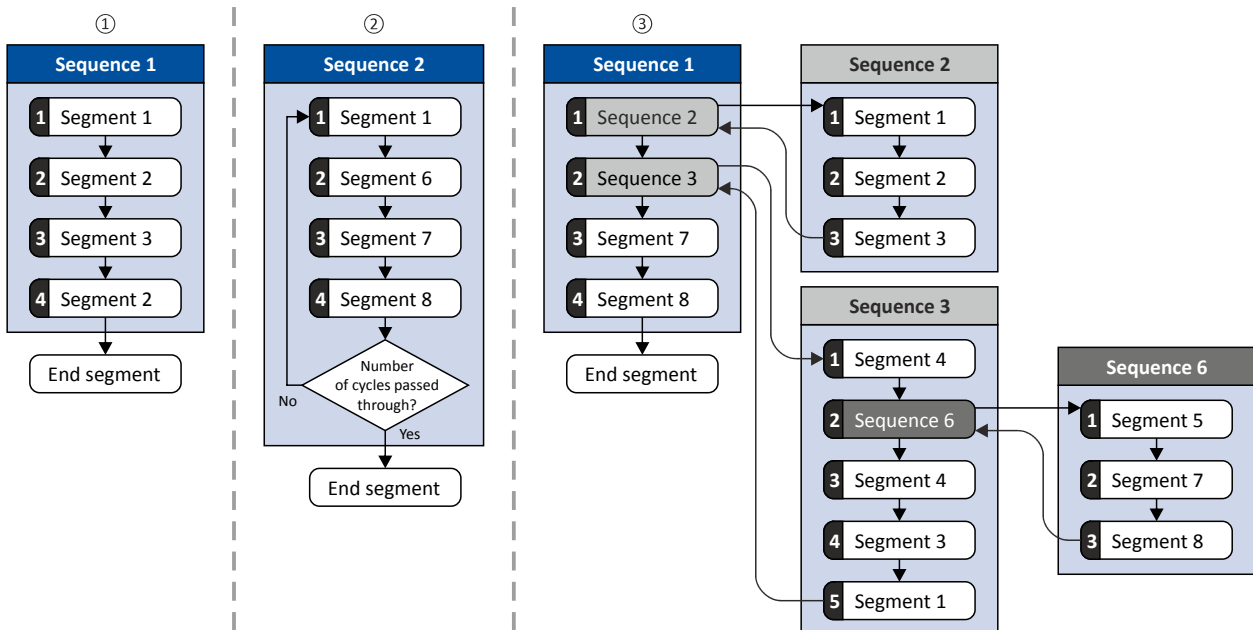

- ① Simple sequence with four steps.
- ② Simple sequence with four steps that are passed through several times (number of cycles > 1). For each sequence, the number of cycles can be set individually.
- ③ Nested sequence: Other (sub) sequences are called by one (main) sequence.



Commissioning

For commissioning the sequencer, we recommend the following proceeding:

1. Configure segments (including end segment).
 Details: [▶ Segment configuration](#) 464
2. Configure sequences:
 - a) Assign the segments to the single steps of a sequence.
 - b) Set the number of cycles for the respective sequence.
 Details: [▶ Sequence configuration](#) 474
3. Make the basic setting of the sequencer:
 - a) Set the desired operating mode (time and/or step operation).
 - b) Optionally: Adapt end of sequence mode and start of sequence mode.
 Details: [▶ Sequencer basic settings](#) 489
4. Configure the control of the sequencer:
 - a) Assign the functions for selecting a sequence to suitable triggers (e. g. digital inputs).
 - b) Assign the functions for controlling the sequencer (start, stop, cancel, ...) to suitable triggers.
 Details: [▶ Sequencer control functions](#) 559

Control

The functions listed in the following table serve to control the sequencer. For details, see chapter "[Sequencer control functions](#)". 559

Function	Info
Select sequence (bit 0) ... Select sequence (bit 3)	Bit coded selection of the sequence to be started.
Start sequence	The selected sequence is started. The start can take place edge or status-controlled depending on the configuration.
Next sequence step	Immediate jump to the next step irrespective of the time set for the segment.
Pause sequence	The sequencer stops in the current step. The expiration for the time set for the segment is stopped. The sequencer setpoint remains active.
Suspend sequence	There is a temporal return to the normal setpoint control. The sequence is then continued at the point where it was suspended.
Stop sequence	Direct jump to the end segment. The further execution depends on the selected end of sequence mode.
Abort sequence	Immediate return to the normal setpoint control. The end segment is not executed anymore.

Diagnostics

For diagnosing the sequencer, the diagnostic parameters listed in chapter "[Sequencer diagnostics](#)" are available. 109

Internal status signals

The sequencer provides different internal status signals (see the following table). These status signals can be assigned to the relay, the digital outputs or the status word. [▶ Configuration of digital outputs](#) 574

Internal status signal	Info
"Sequencer controlled [100]"	The control is executed via the sequencer (according to the configuration of the digital outputs for the current segment).
"Sequence active [101]"	The sequence is running and is currently not suspended.
"Sequence suspended [102]"	The sequence is currently suspended.
"Sequence done [103]"	The sequence is completed (end segment was passed through).



11.1 Segment configuration

Each step of a sequence can call a "segment". A segment contains, among other things preset setpoints (speed setpoint, PID control value, torque setpoint), a combined acceleration/deceleration for the speed setpoint and optionally a configuration for the digital and analog outputs.

Details

As a total, 8 segments and one end segment can be configured.

- The settings are only effective if a sequence is active and the respective segment is executed.
- Not all settings are relevant for all operating modes. If, for instance, the PID control is not used at all, no PID setpoint needs to be set for the segment.
- The following figure shows the segment settings relevant for the operating mode **0x6060 (P301.00) = "MS: Velocity mode [-2]"**.
- The table below contains a short overview of the possible settings for each segment.

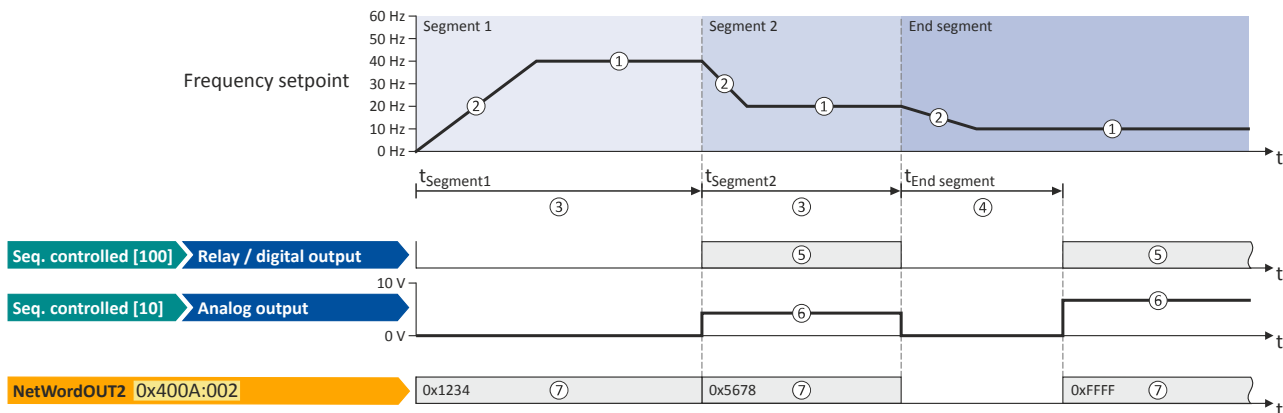

Setting	Info
Frequency setpoint	① Only relevant for the operating mode 0x6060 (P301.00) = "MS: Velocity mode [-2]" . direction of rotation according to sign.
Acceleration/deceleration	② Only relevant for operating mode 0x6060 (P301.00) = "MS: Velocity mode [-2]" . The set time refers to the acceleration from standstill to the set maximum frequency. The deceleration is effected with the same ramp.
Time	③ Meaning for segment 1 ... 8: Runtime for the segment after the expiry of which it is switched over to the next step of the sequence. Only relevant for Sequencer mode 0x4025 (P800.00) = "Time operation [1]" or "Time & step operation [3]".
	④ Meaning for end segment: Delay time for activating the output states configured for the end segment.
Digital outputs	⑤ Optionally: Set digital outputs to a certain level for the execution time of the segment.
Analog outputs	⑥ Optionally: Set analog outputs to an adjustable voltage value for the execution time of the segment.
PID setpoint	Only relevant if the PID control in 0x4020:001 (P600.01) is activated. ▶ Configuring the process controller 356
Torque setpoint	Only relevant for operating mode 0x6060 (P301.00) = "MS: Torque mode [-1]" . ▶ Torque control w/ freq. limit 179
NetWordOUT2	⑦ Optionally: Set NetWordOUT2 data word for the execution time of the segment to an adjustable value. The NetWordOUT2 data word 0x400A:002 (P591.02) can be mapped to a network register to transfer the set value as process data. ▶ Further process data 226

In the following, all parameters relevant for the segment configuration are given.



If the sequencer is active, write access to all parameters are blocked that concern the active segment configuration!



Sequencer

Segment configuration

Parameter	Name / value range / [default setting]	Info
0x4026:001 (P801.01)	Sequencer segment 1: Frequency setpoint (Segment 1: Frequency setp.) -599.0 ... [0.0] ... 599.0 Hz • From version 03.00	Frequency setpoint for the segment. • Only relevant for operating mode 0x6060 (P301.00) = "MS: Velocity mode [-2]". • Direction of rotation according to sign.
0x4026:002 (P801.02)	Sequencer segment 1: Acceleration/deceleration (Segment 1: Accel./decel.) 0.0 ... [5.0] ... 3600.0 s • From version 03.00	Acceleration/deceleration for the segment. • Only relevant for operating mode 0x6060 (P301.00) = "MS: Velocity mode [-2]". • The set time refers to the acceleration from standstill to the set maximum frequency. The deceleration is effected with the same ramp.
0x4026:003 (P801.03)	Sequencer segment 1: Time (Segment 1: Time) 0.0 ... [0.0] ... 100000.0 s • From version 03.00	Runtime for the segment after the expiry of which it is switched over to the next step of the sequence. • Only relevant for Sequencer mode 0x4025 (P800.00) = "Time operation [1]" or "Time & step operation [3]". • With the setting "0.0", the segment will be skipped.
0x4026:004 (P801.04)	Sequencer segment 1: Digital outputs (Segment 1: Digital outp.) 0 ... [0] ... 255 • From version 03.00	Optionally: Set digital outputs to the level set here for the execution time of the segment. Note! In order that the control of a digital output is executed by the sequencer, the following assignment must be made for the respective digital output: • Relay: 0x2634:001 (P420.01) = "Sequencer controlled [100]" • Digital output 1: 0x2634:002 (P420.02) = "Sequencer controlled [100]" • Digital output 2: 0x2634:003 (P420.03) = "Sequencer controlled [100]"
	Bit 0 Relay	0 = X9/NO-COM open and NC-COM closed. 1 = X9/NO-COM closed and NC-COM open. An inversion set in 0x2635:001 (P421.01) is taken into consideration here.
	Bit 1 Digital output 1	0 = set digital output 1 to LOW level. 1 = set digital output 1 to HIGH level. An inversion set in 0x2635:002 (P421.02) is taken into consideration here.
	Bit 2 Digital output 2	0 = set digital output 2 to LOW level. 1 = set digital output 2 to HIGH level. An inversion set in 0x2635:003 (P421.03) is taken into consideration here.
0x4026:005 (P801.05)	Sequencer segment 1: Analog outputs (Segment 1: Analog outp.) 0.00 ... [0.00] ... 10.00 VDC • From version 03.00	Optionally: Set analog outputs to the voltage value set here for the execution time of the segment. Note! In order that the control of an analog output is executed by the sequencer, the following assignment must be made for the respective analog output: • Analog output 1: 0x2639:002 (P440.02) = "Sequencer controlled [10]" • Analog output 2: 0x263A:002 (P441.02) = "Sequencer controlled [10]"
0x4026:006 (P801.06)	Sequencer segment 1: PID setpoint (Segment 1: PID setp.) -300.00 ... [0.00] ... 300.00 PID unit • From version 03.00	PID control value for the segment. • Only relevant if the PID control in 0x4020:001 (P600.01) is activated.
0x4026:007 (P801.07)	Sequencer segment 1: Torque setpoint (Segment 1: Torque setp.) -400.0 ... [100.0] ... 400.0 % • From version 03.00	Torque setpoint for the segment. • Only relevant for operating mode 0x6060 (P301.00) = "MS: Torque mode [-1]".
0x4026:008	Sequencer segment 1: NetWordOUT2 0 ... [0] ... 65535 • From version 03.00	Optionally: Set the NetWordOUT2 data word to the value set here for the execution time of the segment. • The NetWordOUT2 data word 0x400A:002 (P591.02) can be mapped to a network register to transfer the set value as process date.
0x4026:009	Sequencer segment 1: Position setpoint 0 ... [0] ... 4294967295 • From version 03.00	
0x4027:001 (P802.01)	Sequencer segment 2: Frequency setpoint (Segment 2: Frequency setp.) -599.0 ... [0.0] ... 599.0 Hz • From version 03.00	Frequency setpoint for the segment. • Only relevant for operating mode 0x6060 (P301.00) = "MS: Velocity mode [-2]". • Direction of rotation according to sign.

Sequencer

Segment configuration



Parameter	Name / value range / [default setting]	Info
0x4027:002 (P802.02)	Sequencer segment 2: Acceleration/deceleration (Segment 2: Accel./decel.) 0.0 ... [5.0] ... 3600.0 s • From version 03.00	Acceleration/deceleration for the segment. • Only relevant for operating mode 0x6060 (P301.00) = "MS: Velocity mode [-2]". • The set time refers to the acceleration from standstill to the set maximum frequency. The deceleration is effected with the same ramp.
0x4027:003 (P802.03)	Sequencer segment 2: Time (Segment 2: Time) 0.0 ... [0.0] ... 100000.0 s • From version 03.00	Runtime for the segment after the expiry of which it is switched over to the next step of the sequence. • Only relevant for Sequencer mode 0x4025 (P800.00) = "Time operation [1]" or "Time & step operation [3]". • With the setting "0.0", the segment will be skipped.
0x4027:004 (P802.04)	Sequencer segment 2: Digital outputs (Segment 2: Digital outp.) 0 ... [0] ... 255 • From version 03.00	Optionally: Set digital outputs to the level set here for the execution time of the segment. Note! In order that the control of a digital output is executed by the sequencer, the following assignment must be made for the respective digital output: • Relay: 0x2634:001 (P420.01) = "Sequencer controlled [100]" • Digital output 1: 0x2634:002 (P420.02) = "Sequencer controlled [100]" • Digital output 2: 0x2634:003 (P420.03) = "Sequencer controlled [100]"
	Bit 0 Relay	0 = X9/NO-COM open and NC-COM closed. 1 = X9/NO-COM closed and NC-COM open. An inversion set in 0x2635:001 (P421.01) is taken into consideration here.
	Bit 1 Digital output 1	0 = set digital output 1 to LOW level. 1 = set digital output 1 to HIGH level. An inversion set in 0x2635:002 (P421.02) is taken into consideration here.
	Bit 2 Digital output 2	0 = set digital output 2 to LOW level. 1 = set digital output 2 to HIGH level. An inversion set in 0x2635:003 (P421.03) is taken into consideration here.
0x4027:005 (P802.05)	Sequencer segment 2: Analog outputs (Segment 2: Analog outp.) 0.00 ... [0.00] ... 10.00 VDC • From version 03.00	Optionally: Set analog outputs to the voltage value set here for the execution time of the segment. Note! In order that the control of an analog output is executed by the sequencer, the following assignment must be made for the respective analog output: • Analog output 1: 0x2639:002 (P440.02) = "Sequencer controlled [10]" • Analog output 2: 0x263A:002 (P441.02) = "Sequencer controlled [10]"
0x4027:006 (P802.06)	Sequencer segment 2: PID setpoint (Segment 2: PID setp.) -300.00 ... [0.00] ... 300.00 PID unit • From version 03.00	PID control value for the segment. • Only relevant if the PID control in 0x4020:001 (P600.01) is activated.
0x4027:007 (P802.07)	Sequencer segment 2: Torque setpoint (Segment 2: Torque setp.) -400.0 ... [100.0] ... 400.0 % • From version 03.00	Torque setpoint for the segment. • Only relevant for operating mode 0x6060 (P301.00) = "MS: Torque mode [-1]".
0x4027:008	Sequencer segment 2: NetWordOUT2 0 ... [0] ... 65535 • From version 03.00	Optionally: Set the NetWordOUT2 data word to the value set here for the execution time of the segment. • The NetWordOUT2 data word 0x400A:002 (P591.02) can be mapped to a network register to transfer the set value as process date.
0x4027:009	Sequencer segment 2: Position setpoint 0 ... [0] ... 4294967295 • From version 03.00	
0x4028:001 (P803.01)	Sequencer segment 3: Frequency setpoint (Segment 3: Frequency setp.) -599.0 ... [0.0] ... 599.0 Hz • From version 03.00	Frequency setpoint for the segment. • Only relevant for operating mode 0x6060 (P301.00) = "MS: Velocity mode [-2]". • Direction of rotation according to sign.
0x4028:002 (P803.02)	Sequencer segment 3: Acceleration/deceleration (Segment 3: Accel./decel.) 0.0 ... [5.0] ... 3600.0 s • From version 03.00	Acceleration/deceleration for the segment. • Only relevant for operating mode 0x6060 (P301.00) = "MS: Velocity mode [-2]". • The set time refers to the acceleration from standstill to the set maximum frequency. The deceleration is effected with the same ramp.



Sequencer

Segment configuration

Parameter	Name / value range / [default setting]	Info
0x4028:003 (P803.03)	Sequencer segment 3: Time (Segment 3: Time) 0.0 ... [0.0] ... 100000.0 s • From version 03.00	Runtime for the segment after the expiry of which it is switched over to the next step of the sequence. • Only relevant for Sequencer mode 0x4025 (P800.00) = "Time operation [1]" or "Time & step operation [3]". • With the setting "0.0", the segment will be skipped.
0x4028:004 (P803.04)	Sequencer segment 3: Digital outputs (Segment 3: Digital outp.) 0 ... [0] ... 255 • From version 03.00	Optionally: Set digital outputs to the level set here for the execution time of the segment. Note! In order that the control of a digital output is executed by the sequencer, the following assignment must be made for the respective digital output: • Relay: 0x2634:001 (P420.01) = "Sequencer controlled [100]" • Digital output 1: 0x2634:002 (P420.02) = "Sequencer controlled [100]" • Digital output 2: 0x2634:003 (P420.03) = "Sequencer controlled [100]"
	Bit 0 Relay	0 = X9/NO-COM open and NC-COM closed. 1 = X9/NO-COM closed and NC-COM open. An inversion set in 0x2635:001 (P421.01) is taken into consideration here.
	Bit 1 Digital output 1	0 = set digital output 1 to LOW level. 1 = set digital output 1 to HIGH level. An inversion set in 0x2635:002 (P421.02) is taken into consideration here.
	Bit 2 Digital output 2	0 = set digital output 2 to LOW level. 1 = set digital output 2 to HIGH level. An inversion set in 0x2635:003 (P421.03) is taken into consideration here.
0x4028:005 (P803.05)	Sequencer segment 3: Analog outputs (Segment 3: Analog outp.) 0.00 ... [0.00] ... 10.00 VDC • From version 03.00	Optionally: Set analog outputs to the voltage value set here for the execution time of the segment. Note! In order that the control of an analog output is executed by the sequencer, the following assignment must be made for the respective analog output: • Analog output 1: 0x2639:002 (P440.02) = "Sequencer controlled [10]" • Analog output 2: 0x263A:002 (P441.02) = "Sequencer controlled [10]"
0x4028:006 (P803.06)	Sequencer segment 3: PID setpoint (Segment 3: PID setp.) -300.00 ... [0.00] ... 300.00 PID unit • From version 03.00	PID control value for the segment. • Only relevant if the PID control in 0x4020:001 (P600.01) is activated.
0x4028:007 (P803.07)	Sequencer segment 3: Torque setpoint (Segment 3: Torque setp.) -400.0 ... [100.0] ... 400.0 % • From version 03.00	Torque setpoint for the segment. • Only relevant for operating mode 0x6060 (P301.00) = "MS: Torque mode [-1]".
0x4028:008	Sequencer segment 3: NetWordOUT2 0 ... [0] ... 65535 • From version 03.00	Optionally: Set the NetWordOUT2 data word to the value set here for the execution time of the segment. • The NetWordOUT2 data word 0x400A:002 (P591.02) can be mapped to a network register to transfer the set value as process date.
0x4028:009	Sequencer segment 3: Position setpoint 0 ... [0] ... 4294967295 • From version 03.00	
0x4029:001 (P804.01)	Sequencer segment 4: Frequency setpoint (Segment 4: Frequency setp.) -599.0 ... [0.0] ... 599.0 Hz • From version 03.00	Frequency setpoint for the segment. • Only relevant for operating mode 0x6060 (P301.00) = "MS: Velocity mode [-2]". • Direction of rotation according to sign.
0x4029:002 (P804.02)	Sequencer segment 4: Acceleration/deceleration (Segment 4: Accel./decel.) 0.0 ... [5.0] ... 3600.0 s • From version 03.00	Acceleration/deceleration for the segment. • Only relevant for operating mode 0x6060 (P301.00) = "MS: Velocity mode [-2]". • The set time refers to the acceleration from standstill to the set maximum frequency. The deceleration is effected with the same ramp.
0x4029:003 (P804.03)	Sequencer segment 4: Time (Segment 4: Time) 0.0 ... [0.0] ... 100000.0 s • From version 03.00	Runtime for the segment after the expiry of which it is switched over to the next step of the sequence. • Only relevant for Sequencer mode 0x4025 (P800.00) = "Time operation [1]" or "Time & step operation [3]". • With the setting "0.0", the segment will be skipped.

Sequencer

Segment configuration



Parameter	Name / value range / [default setting]	Info
0x4029:004 (P804.04)	Sequencer segment 4: Digital outputs (Segment 4: Digital outp.) 0 ... [0] ... 255 • From version 03.00	Optionally: Set digital outputs to the level set here for the execution time of the segment. Note! In order that the control of a digital output is executed by the sequencer, the following assignment must be made for the respective digital output: • Relay: 0x2634:001 (P420.01) = "Sequencer controlled [100]" • Digital output 1: 0x2634:002 (P420.02) = "Sequencer controlled [100]" • Digital output 2: 0x2634:003 (P420.03) = "Sequencer controlled [100]"
	Bit 0 Relay	0 = X9/NO-COM open and NC-COM closed. 1 = X9/NO-COM closed and NC-COM open. An inversion set in 0x2635:001 (P421.01) is taken into consideration here.
	Bit 1 Digital output 1	0 = set digital output 1 to LOW level. 1 = set digital output 1 to HIGH level. An inversion set in 0x2635:002 (P421.02) is taken into consideration here.
	Bit 2 Digital output 2	0 = set digital output 2 to LOW level. 1 = set digital output 2 to HIGH level. An inversion set in 0x2635:003 (P421.03) is taken into consideration here.
0x4029:005 (P804.05)	Sequencer segment 4: Analog outputs (Segment 4: Analog outp.) 0.00 ... [0.00] ... 10.00 VDC • From version 03.00	Optionally: Set analog outputs to the voltage value set here for the execution time of the segment. Note! In order that the control of an analog output is executed by the sequencer, the following assignment must be made for the respective analog output: • Analog output 1: 0x2639:002 (P440.02) = "Sequencer controlled [10]" • Analog output 2: 0x263A:002 (P441.02) = "Sequencer controlled [10]"
0x4029:006 (P804.06)	Sequencer segment 4: PID setpoint (Segment 4: PID setp.) -300.00 ... [0.00] ... 300.00 PID unit • From version 03.00	PID control value for the segment. • Only relevant if the PID control in 0x4020:001 (P600.01) is activated.
0x4029:007 (P804.07)	Sequencer segment 4: Torque setpoint (Segment 4: Torque setp.) -400.0 ... [100.0] ... 400.0 % • From version 03.00	Torque setpoint for the segment. • Only relevant for operating mode 0x6060 (P301.00) = "MS: Torque mode [-1]".
0x4029:008	Sequencer segment 4: NetWordOUT2 0 ... [0] ... 65535 • From version 03.00	Optionally: Set the NetWordOUT2 data word to the value set here for the execution time of the segment. • The NetWordOUT2 data word 0x400A:002 (P591.02) can be mapped to a network register to transfer the set value as process date.
0x4029:009	Sequencer segment 4: Position setpoint 0 ... [0] ... 4294967295 • From version 03.00	
0x402A:001 (P805.01)	Sequencer segment 5: Frequency setpoint (Segment 5: Frequency setp.) -599.0 ... [0.0] ... 599.0 Hz • From version 03.00	Frequency setpoint for the segment. • Only relevant for operating mode 0x6060 (P301.00) = "MS: Velocity mode [-2]". • Direction of rotation according to sign.
0x402A:002 (P805.02)	Sequencer segment 5: Acceleration/deceleration (Segment 5: Accel./decel.) 0.0 ... [5.0] ... 3600.0 s • From version 03.00	Acceleration/deceleration for the segment. • Only relevant for operating mode 0x6060 (P301.00) = "MS: Velocity mode [-2]". • The set time refers to the acceleration from standstill to the set maximum frequency. The deceleration is effected with the same ramp.
0x402A:003 (P805.03)	Sequencer segment 5: Time (Segment 5: Time) 0.0 ... [0.0] ... 100000.0 s • From version 03.00	Runtime for the segment after the expiry of which it is switched over to the next step of the sequence. • Only relevant for Sequencer mode 0x4025 (P800.00) = "Time operation [1]" or "Time & step operation [3]". • With the setting "0.0", the segment will be skipped.



Sequencer

Segment configuration

Parameter	Name / value range / [default setting]	Info
0x402A:004 (P805.04)	Sequencer segment 5: Digital outputs (Segment 5: Digital outp.) 0 ... [0] ... 255 <ul style="list-style-type: none"> From version 03.00 	Optionally: Set digital outputs to the level set here for the execution time of the segment. Note! In order that the control of a digital output is executed by the sequencer, the following assignment must be made for the respective digital output: <ul style="list-style-type: none"> Relay: 0x2634:001 (P420.01) = "Sequencer controlled [100]" Digital output 1: 0x2634:002 (P420.02) = "Sequencer controlled [100]" Digital output 2: 0x2634:003 (P420.03) = "Sequencer controlled [100]"
	Bit 0 Relay	0 = X9/NO-COM open and NC-COM closed. 1 = X9/NO-COM closed and NC-COM open. An inversion set in 0x2635:001 (P421.01) is taken into consideration here.
	Bit 1 Digital output 1	0 = set digital output 1 to LOW level. 1 = set digital output 1 to HIGH level. An inversion set in 0x2635:002 (P421.02) is taken into consideration here.
	Bit 2 Digital output 2	0 = set digital output 2 to LOW level. 1 = set digital output 2 to HIGH level. An inversion set in 0x2635:003 (P421.03) is taken into consideration here.
0x402A:005 (P805.05)	Sequencer segment 5: Analog outputs (Segment 5: Analog outp.) 0.00 ... [0.00] ... 10.00 VDC <ul style="list-style-type: none"> From version 03.00 	Optionally: Set analog outputs to the voltage value set here for the execution time of the segment. Note! In order that the control of an analog output is executed by the sequencer, the following assignment must be made for the respective analog output: <ul style="list-style-type: none"> Analog output 1: 0x2639:002 (P440.02) = "Sequencer controlled [10]" Analog output 2: 0x263A:002 (P441.02) = "Sequencer controlled [10]"
0x402A:006 (P805.06)	Sequencer segment 5: PID setpoint (Segment 5: PID setp.) -300.00 ... [0.00] ... 300.00 PID unit <ul style="list-style-type: none"> From version 03.00 	PID control value for the segment. <ul style="list-style-type: none"> Only relevant if the PID control in 0x4020:001 (P600.01) is activated.
0x402A:007 (P805.07)	Sequencer segment 5: Torque setpoint (Segment 5: Torque setp.) -400.0 ... [100.0] ... 400.0 % <ul style="list-style-type: none"> From version 03.00 	Torque setpoint for the segment. <ul style="list-style-type: none"> Only relevant for operating mode 0x6060 (P301.00) = "MS: Torque mode [-1]".
0x402A:008	Sequencer segment 5: NetWordOUT2 0 ... [0] ... 65535 <ul style="list-style-type: none"> From version 03.00 	Optionally: Set the NetWordOUT2 data word to the value set here for the execution time of the segment. <ul style="list-style-type: none"> The NetWordOUT2 data word 0x400A:002 (P591.02) can be mapped to a network register to transfer the set value as process date.
0x402A:009	Sequencer segment 5: Position setpoint 0 ... [0] ... 4294967295 <ul style="list-style-type: none"> From version 03.00 	
0x402B:001 (P806.01)	Sequencer segment 6: Frequency setpoint (Segment 6: Frequency setp.) -599.0 ... [0.0] ... 599.0 Hz <ul style="list-style-type: none"> From version 03.00 	Frequency setpoint for the segment. <ul style="list-style-type: none"> Only relevant for operating mode 0x6060 (P301.00) = "MS: Velocity mode [-2]". Direction of rotation according to sign.
0x402B:002 (P806.02)	Sequencer segment 6: Acceleration/deceleration (Segment 6: Accel./decel.) 0.0 ... [5.0] ... 3600.0 s <ul style="list-style-type: none"> From version 03.00 	Acceleration/deceleration for the segment. <ul style="list-style-type: none"> Only relevant for operating mode 0x6060 (P301.00) = "MS: Velocity mode [-2]". The set time refers to the acceleration from standstill to the set maximum frequency. The deceleration is effected with the same ramp.
0x402B:003 (P806.03)	Sequencer segment 6: Time (Segment 6: Time) 0.0 ... [0.0] ... 100000.0 s <ul style="list-style-type: none"> From version 03.00 	Runtime for the segment after the expiry of which it is switched over to the next step of the sequence. <ul style="list-style-type: none"> Only relevant for Sequencer mode 0x4025 (P800.00) = "Time operation [1]" or "Time & step operation [3]". With the setting "0.0", the segment will be skipped.

Sequencer

Segment configuration



Parameter	Name / value range / [default setting]	Info
0x402B:004 (P806.04)	Sequencer segment 6: Digital outputs (Segment 6: Digital outp.) 0 ... [0] ... 255 • From version 03.00	Optionally: Set digital outputs to the level set here for the execution time of the segment. Note! In order that the control of a digital output is executed by the sequencer, the following assignment must be made for the respective digital output: • Relay: 0x2634:001 (P420.01) = "Sequencer controlled [100]" • Digital output 1: 0x2634:002 (P420.02) = "Sequencer controlled [100]" • Digital output 2: 0x2634:003 (P420.03) = "Sequencer controlled [100]"
	Bit 0 Relay	0 = X9/NO-COM open and NC-COM closed. 1 = X9/NO-COM closed and NC-COM open. An inversion set in 0x2635:001 (P421.01) is taken into consideration here.
	Bit 1 Digital output 1	0 = set digital output 1 to LOW level. 1 = set digital output 1 to HIGH level. An inversion set in 0x2635:002 (P421.02) is taken into consideration here.
	Bit 2 Digital output 2	0 = set digital output 2 to LOW level. 1 = set digital output 2 to HIGH level. An inversion set in 0x2635:003 (P421.03) is taken into consideration here.
0x402B:005 (P806.05)	Sequencer segment 6: Analog outputs (Segment 6: Analog outp.) 0.00 ... [0.00] ... 10.00 VDC • From version 03.00	Optionally: Set analog outputs to the voltage value set here for the execution time of the segment. Note! In order that the control of an analog output is executed by the sequencer, the following assignment must be made for the respective analog output: • Analog output 1: 0x2639:002 (P440.02) = "Sequencer controlled [10]" • Analog output 2: 0x263A:002 (P441.02) = "Sequencer controlled [10]"
0x402B:006 (P806.06)	Sequencer segment 6: PID setpoint (Segment 6: PID setp.) -300.00 ... [0.00] ... 300.00 PID unit • From version 03.00	PID control value for the segment. • Only relevant if the PID control in 0x4020:001 (P600.01) is activated.
0x402B:007 (P806.07)	Sequencer segment 6: Torque setpoint (Segment 6: Torque setp.) -400.0 ... [100.0] ... 400.0 % • From version 03.00	Torque setpoint for the segment. • Only relevant for operating mode 0x6060 (P301.00) = "MS: Torque mode [-1]".
0x402B:008	Sequencer segment 6: NetWordOUT2 0 ... [0] ... 65535 • From version 03.00	Optionally: Set the NetWordOUT2 data word to the value set here for the execution time of the segment. • The NetWordOUT2 data word 0x400A:002 (P591.02) can be mapped to a network register to transfer the set value as process date.
0x402B:009	Sequencer segment 6: Position setpoint 0 ... [0] ... 4294967295 • From version 03.00	
0x402C:001 (P807.01)	Sequencer segment 7: Frequency setpoint (Segment 7: Frequency setp.) -599.0 ... [0.0] ... 599.0 Hz • From version 03.00	Frequency setpoint for the segment. • Only relevant for operating mode 0x6060 (P301.00) = "MS: Velocity mode [-2]". • Direction of rotation according to sign.
0x402C:002 (P807.02)	Sequencer segment 7: Acceleration/deceleration (Segment 7: Accel./decel.) 0.0 ... [5.0] ... 3600.0 s • From version 03.00	Acceleration/deceleration for the segment. • Only relevant for operating mode 0x6060 (P301.00) = "MS: Velocity mode [-2]". • The set time refers to the acceleration from standstill to the set maximum frequency. The deceleration is effected with the same ramp.
0x402C:003 (P807.03)	Sequencer segment 7: Time (Segment 7: Time) 0.0 ... [0.0] ... 100000.0 s • From version 03.00	Runtime for the segment after the expiry of which it is switched over to the next step of the sequence. • Only relevant for Sequencer mode 0x4025 (P800.00) = "Time operation [1]" or "Time & step operation [3]". • With the setting "0.0", the segment will be skipped.



Parameter	Name / value range / [default setting]	Info
0x402C:004 (P807.04)	Sequencer segment 7: Digital outputs (Segment 7: Digital outp.) 0 ... [0] ... 255 • From version 03.00	Optionally: Set digital outputs to the level set here for the execution time of the segment. Note! In order that the control of a digital output is executed by the sequencer, the following assignment must be made for the respective digital output: • Relay: 0x2634:001 (P420.01) = "Sequencer controlled [100]" • Digital output 1: 0x2634:002 (P420.02) = "Sequencer controlled [100]" • Digital output 2: 0x2634:003 (P420.03) = "Sequencer controlled [100]"
	Bit 0 Relay	0 = X9/NO-COM open and NC-COM closed. 1 = X9/NO-COM closed and NC-COM open. An inversion set in 0x2635:001 (P421.01) is taken into consideration here.
	Bit 1 Digital output 1	0 = set digital output 1 to LOW level. 1 = set digital output 1 to HIGH level. An inversion set in 0x2635:002 (P421.02) is taken into consideration here.
	Bit 2 Digital output 2	0 = set digital output 2 to LOW level. 1 = set digital output 2 to HIGH level. An inversion set in 0x2635:003 (P421.03) is taken into consideration here.
0x402C:005 (P807.05)	Sequencer segment 7: Analog outputs (Segment 7: Analog outp.) 0.00 ... [0.00] ... 10.00 VDC • From version 03.00	Optionally: Set analog outputs to the voltage value set here for the execution time of the segment. Note! In order that the control of an analog output is executed by the sequencer, the following assignment must be made for the respective analog output: • Analog output 1: 0x2639:002 (P440.02) = "Sequencer controlled [10]" • Analog output 2: 0x263A:002 (P441.02) = "Sequencer controlled [10]"
0x402C:006 (P807.06)	Sequencer segment 7: PID setpoint (Segment 7: PID setp.) -300.00 ... [0.00] ... 300.00 PID unit • From version 03.00	PID control value for the segment. • Only relevant if the PID control in 0x4020:001 (P600.01) is activated.
0x402C:007 (P807.07)	Sequencer segment 7: Torque setpoint (Segment 7: Torque setp.) -400.0 ... [100.0] ... 400.0 % • From version 03.00	Torque setpoint for the segment. • Only relevant for operating mode 0x6060 (P301.00) = "MS: Torque mode [-1]".
0x402C:008	Sequencer segment 7: NetWordOUT2 0 ... [0] ... 65535 • From version 03.00	Optionally: Set the NetWordOUT2 data word to the value set here for the execution time of the segment. • The NetWordOUT2 data word 0x400A:002 (P591.02) can be mapped to a network register to transfer the set value as process date.
0x402C:009	Sequencer segment 7: Position setpoint 0 ... [0] ... 4294967295 • From version 03.00	
0x402D:001 (P808.01)	Sequencer segment 8: Frequency setpoint (Segment 8: Frequency setp.) -599.0 ... [0.0] ... 599.0 Hz • From version 03.00	Frequency setpoint for the segment. • Only relevant for operating mode 0x6060 (P301.00) = "MS: Velocity mode [-2]". • Direction of rotation according to sign.
0x402D:002 (P808.02)	Sequencer segment 8: Acceleration/deceleration (Segment 8: Accel./decel.) 0.0 ... [5.0] ... 3600.0 s • From version 03.00	Acceleration/deceleration for the segment. • Only relevant for operating mode 0x6060 (P301.00) = "MS: Velocity mode [-2]". • The set time refers to the acceleration from standstill to the set maximum frequency. The deceleration is effected with the same ramp.
0x402D:003 (P808.03)	Sequencer segment 8: Time (Segment 8: Time) 0.0 ... [0.0] ... 100000.0 s • From version 03.00	Runtime for the segment after the expiry of which it is switched over to the next step of the sequence. • Only relevant for Sequencer mode 0x4025 (P800.00) = "Time operation [1]" or "Time & step operation [3]". • With the setting "0.0", the segment will be skipped.

Sequencer

Segment configuration



Parameter	Name / value range / [default setting]	Info
0x402D:004 (P808.04)	Sequencer segment 8: Digital outputs (Segment 8: Digital outp.) 0 ... [0] ... 255 • From version 03.00	Optionally: Set digital outputs to the level set here for the execution time of the segment. Note! In order that the control of a digital output is executed by the sequencer, the following assignment must be made for the respective digital output: • Relay: 0x2634:001 (P420.01) = "Sequencer controlled [100]" • Digital output 1: 0x2634:002 (P420.02) = "Sequencer controlled [100]" • Digital output 2: 0x2634:003 (P420.03) = "Sequencer controlled [100]"
	Bit 0 Relay	0 = X9/NO-COM open and NC-COM closed. 1 = X9/NO-COM closed and NC-COM open. An inversion set in 0x2635:001 (P421.01) is taken into consideration here.
	Bit 1 Digital output 1	0 = set digital output 1 to LOW level. 1 = set digital output 1 to HIGH level. An inversion set in 0x2635:002 (P421.02) is taken into consideration here.
	Bit 2 Digital output 2	0 = set digital output 2 to LOW level. 1 = set digital output 2 to HIGH level. An inversion set in 0x2635:003 (P421.03) is taken into consideration here.
0x402D:005 (P808.05)	Sequencer segment 8: Analog outputs (Segment 8: Analog outp.) 0.00 ... [0.00] ... 10.00 VDC • From version 03.00	Optionally: Set analog outputs to the voltage value set here for the execution time of the segment. Note! In order that the control of an analog output is executed by the sequencer, the following assignment must be made for the respective analog output: • Analog output 1: 0x2639:002 (P440.02) = "Sequencer controlled [10]" • Analog output 2: 0x263A:002 (P441.02) = "Sequencer controlled [10]"
0x402D:006 (P808.06)	Sequencer segment 8: PID setpoint (Segment 8: PID setp.) -300.00 ... [0.00] ... 300.00 PID unit • From version 03.00	PID control value for the segment. • Only relevant if the PID control in 0x4020:001 (P600.01) is activated.
0x402D:007 (P808.07)	Sequencer segment 8: Torque setpoint (Segment 8: Torque setp.) -400.0 ... [100.0] ... 400.0 % • From version 03.00	Torque setpoint for the segment. • Only relevant for operating mode 0x6060 (P301.00) = "MS: Torque mode [-1]".
0x402D:008	Sequencer segment 8: NetWordOUT2 0 ... [0] ... 65535 • From version 03.00	Optionally: Set the NetWordOUT2 data word to the value set here for the execution time of the segment. • The NetWordOUT2 data word 0x400A:002 (P591.02) can be mapped to a network register to transfer the set value as process date.
0x402D:009	Sequencer segment 8: Position setpoint 0 ... [0] ... 4294967295 • From version 03.00	
0x402E:001 (P822.01)	End segment: Frequency setpoint (End segment: Frequency setp.) -599.0 ... [0.0] ... 599.0 Hz • From version 03.00	Frequency setpoint after the sequence has been completed, i. e., after the steps configured for the sequence have been passed through with the set numbers of cycles. • Only relevant for the operating mode 0x6060 (P301.00) = "MS: Velocity mode [-2]" and if end of sequence mode 0x402F (P824.00) = "Keep running [0]". • Direction of rotation according to sign.
0x402E:002 (P822.02)	End segment: Acceleration/deceleration (End segment: Accel./decel.) 0.0 ... [5.0] ... 3600.0 s • From version 03.00	If end of sequence mode = "continuous operation" (default setting): Acceleration/deceleration for reaching the frequency setpoint set for the end segment after the sequence has been processed. If end of sequence mode = "Stop" or "Stop and abort": Deceleration for reaching standstill after the sequence has been processed. • Only relevant for operating mode 0x6060 (P301.00) = "MS: Velocity mode [-2]". • The set time refers to the acceleration from standstill to the set maximum frequency. The deceleration is effected with the same ramp.



Sequencer

Segment configuration

Parameter	Name / value range / [default setting]	Info
0x402E:003 (P822.03)	End segment: Time (End segment: Time) 0.0 ... [0.0] ... 100000.0 s <ul style="list-style-type: none"> From version 03.00 	Delay time for activating the output states configured for the end segment. <ul style="list-style-type: none"> This parameter has a different meaning than the time settings for the segments 1 ... 8! The set deceleration time starts when the end segment is started to be processed. After the deceleration time has elapsed: <ul style="list-style-type: none"> The digital outputs are (if configured accordingly) set to the levels set in 0x402E:004 (P822.04). The analog outputs are (if configured accordingly) set to the voltage value set in 0x402E:005 (P822.05). The NetWordOUT2 data word is set to the value set in 0x402E:008.
0x402E:004 (P822.04)	End segment: Digital outputs (End segment: Digital outp.) 0 ... [0] ... 255 <ul style="list-style-type: none"> From version 03.00 	Optionally: Set digital outputs to the levels set here after the time set for the end segment.
	Bit 0 Relay	0 = X9/NO-COM open and NC-COM closed. 1 = X9/NO-COM closed and NC-COM open. An inversion set in 0x2635:001 (P421.01) is taken into consideration here.
	Bit 1 Digital output 1	0 = set digital output 1 to LOW level. 1 = set digital output 1 to HIGH level. An inversion set in 0x2635:002 (P421.02) is taken into consideration here.
	Bit 2 Digital output 2	0 = set digital output 2 to LOW level. 1 = set digital output 2 to HIGH level. An inversion set in 0x2635:003 (P421.03) is taken into consideration here.
0x402E:005 (P822.05)	End segment: Analog outputs (End segment: Analog outp.) 0.00 ... [0.00] ... 10.00 VDC <ul style="list-style-type: none"> From version 03.00 	Optionally: Set analog outputs to the voltage value set here after the time set for the end segment. Note! In order that the control of an analog output is executed by the sequencer, the following assignment must be made for the respective analog output: <ul style="list-style-type: none"> Analog output 1: 0x2639:002 (P440.02) = "Sequencer controlled [10]" Analog output 2: 0x263A:002 (P441.02) = "Sequencer controlled [10]"
0x402E:006 (P822.06)	End segment: PID setpoint (End segment: PID setp.) -300.00 ... [0.00] ... 300.00 PID unit <ul style="list-style-type: none"> From version 03.00 	PID control value after the sequence has been completed, i. e., after the steps configured for the sequence have been passed through with the set numbers of cycles. <ul style="list-style-type: none"> Only relevant if PID control is activated in 0x4020:001 (P600.01) and end of sequence mode 0x402F (P824.00) = "Keep running [0]".
0x402E:007 (P822.07)	End segment: Torque setpoint (End segment: Torque setp.) -400.0 ... [100.0] ... 400.0 % <ul style="list-style-type: none"> From version 03.00 	Torque setpoint after the sequence has been completed, i. e., after the steps configured for the sequence have been passed through with the set numbers of cycles. <ul style="list-style-type: none"> Only relevant for the operating mode 0x6060 (P301.00) = "MS: Torque mode [-1]" and if end of sequence mode 0x402F (P824.00) = "Keep running [0]".
0x402E:008	End segment: NetWordOUT2 0 ... [0] ... 65535 <ul style="list-style-type: none"> From version 03.00 	Optionally: Set NetWordOUT2 data word to the value set here after the time set for the end segment. <ul style="list-style-type: none"> The NetWordOUT2 data word 0x400A:002 (P591.02) can be mapped to a network register to transfer the set value as process date.
0x402E:009	End segment: Position setpoint 0 ... [0] ... 4294967295 <ul style="list-style-type: none"> From version 03.00 	



11.2 Sequence configuration

As a total, 8 sequences can be configured (with the numbers 1 to 8). Each sequence consists of 16 configurable steps. Each step of a sequence can call a segment or a complete sequence (with a higher number).

Details

The following example illustrates the configuration based on a nested sequence:

- The sequence 1 is the main sequence which calls further (sub) sequences.
- The main sequence is passed through four times. Afterwards, in the preset "continuous operation" end of sequence mode, the setpoint set for the end segment is continuously transmitted to the motor control until the sequence is aborted.

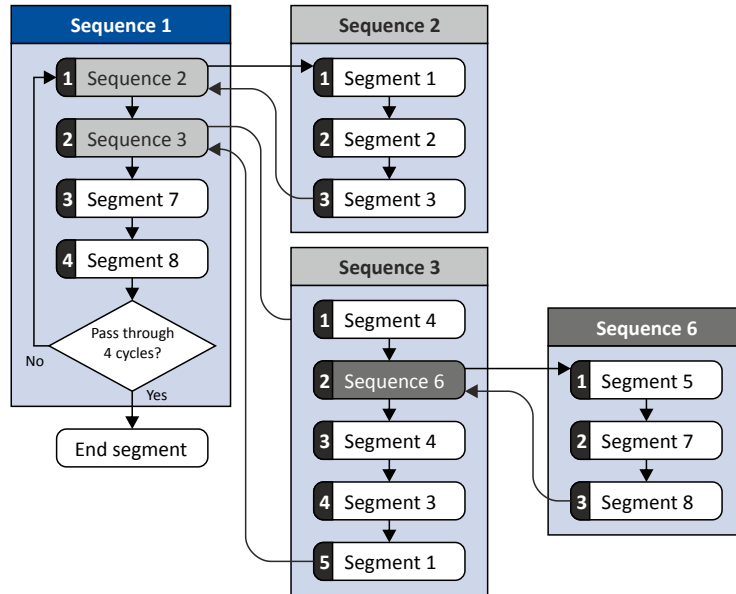

Resulting segment order												
1	2	3	4	5	7	8	4	3	1	7	8	End segment
4 cycles												

Required parameter setting:

	Sequence 1	Sequence 2
Step 1	0x4030:001 (P830.01) = "Sequence 2 [-2]"	0x4032:001 (P835.01) = "Segment 1 [1]"
Step 2	0x4030:002 (P830.02) = "Sequence 3 [-3]"	0x4032:002 (P835.02) = "Segment 2 [2]"
Step 3	0x4030:003 (P830.03) = "Segment 7 [7]"	0x4032:003 (P835.03) = "Segment 3 [3]"
Step 4	0x4030:004 (P830.04) = "Segment 8 [8]"	0x4032:004 (P835.04) = "Skip step [0]"
Step 5	0x4030:005 (P830.05) = "Skip step [0]"	...
Step
Step 16	0x4030:016 (P830.16) = "Skip step [0]"	0x4032:016 (P835.16) = "Skip step [0]"
Number of cycles	0x4031 (P831.00) = 4	0x4033 (P836.00) = 1

	Sequence 3	Sequence 6
Step 1	0x4034:001 (P840.01) = "Segment 4 [4]"	0x403A:001 (P855.01) = "Segment 5 [5]"
Step 2	0x4034:002 (P840.02) = "Sequence 6 [-6]"	0x403A:002 (P855.02) = "Segment 7 [7]"
Step 3	0x4034:003 (P840.03) = "Segment 4 [4]"	0x403A:003 (P855.03) = "Segment 8 [8]"
Step 4	0x4034:004 (P840.04) = "Segment 3 [3]"	0x403A:004 (P855.04) = "Skip step [0]"
Step 5	0x4032:005 (P835.05) = "Segment 1 [1]"	...
Step 6	0x4034:006 (P840.06) = "Skip step [0]"	...
Step
Step 16	0x4034:016 (P840.16) = "Skip step [0]"	0x403A:016 (P855.16) = "Skip step [0]"
Number of cycles	0x4035 (P841.00) = 1	0x403B (P856.00) = 1



In the following, all parameters relevant for the sequence configuration are given.



If the sequencer is active, write access to all parameters are blocked that concern the active sequence configuration!

Parameter	Name / value range / [default setting]	Info
0x4030:001 (P830.01)	Sequence 1: Step 1 (Sequence 1: Step 1)	Configuration of the steps 1 ... 16 for sequence 1. <ul style="list-style-type: none"> Alternatively to calling a single segment, a complete sequence (with a higher number) can also be called from one step. This, for instance, serves to configure a main sequence from which several subsequences are called successively. With the setting "0", the respective step is skipped.
	-8 Sequence 8	
	-7 Sequence 7	
	-6 Sequence 6	
	-5 Sequence 5	
	-4 Sequence 4	
	-3 Sequence 3	
	-2 Sequence 2	
	0 Skip step	
	1 Segment 1	
	2 Segment 2	
	3 Segment 3	
	4 Segment 4	
	5 Segment 5	
	6 Segment 6	
7 Segment 7		
8 Segment 8		
0x4030:002 (P830.02)	Sequence 1: Step 2 (Sequence 1: Step 2)	<ul style="list-style-type: none"> For further possible settings, see parameter 0x4030:001 (P830.01). 475
	0 Skip step	
0x4030:003 (P830.03)	Sequence 1: Step 3 (Sequence 1: Step 3)	<ul style="list-style-type: none"> For further possible settings, see parameter 0x4030:001 (P830.01). 475
	0 Skip step	
0x4030:004 (P830.04)	Sequence 1: Step 4 (Sequence 1: Step 4)	<ul style="list-style-type: none"> For further possible settings, see parameter 0x4030:001 (P830.01). 475
	0 Skip step	
0x4030:005 (P830.05)	Sequence 1: Step 5 (Sequence 1: Step 5)	<ul style="list-style-type: none"> For further possible settings, see parameter 0x4030:001 (P830.01). 475
	0 Skip step	
0x4030:006 (P830.06)	Sequence 1: Step 6 (Sequence 1: Step 6)	<ul style="list-style-type: none"> For further possible settings, see parameter 0x4030:001 (P830.01). 475
	0 Skip step	
0x4030:007 (P830.07)	Sequence 1: Step 7 (Sequence 1: Step 7)	<ul style="list-style-type: none"> For further possible settings, see parameter 0x4030:001 (P830.01). 475
	0 Skip step	
0x4030:008 (P830.08)	Sequence 1: Step 8 (Sequence 1: Step 8)	<ul style="list-style-type: none"> For further possible settings, see parameter 0x4030:001 (P830.01). 475
	0 Skip step	

Sequencer

Sequence configuration



Parameter	Name / value range / [default setting]	Info
0x4030:009 (P830.09)	Sequence 1: Step 9 (Sequence 1: Step 9) <ul style="list-style-type: none"> For further possible settings, see parameter 0x4030:001 (P830.01). 475 	
	0 Skip step	
0x4030:010 (P830.10)	Sequence 1: Step 10 (Sequence 1: Step 10) <ul style="list-style-type: none"> For further possible settings, see parameter 0x4030:001 (P830.01). 475 	
	0 Skip step	
0x4030:011 (P830.11)	Sequence 1: Step 11 (Sequence 1: Step 11) <ul style="list-style-type: none"> For further possible settings, see parameter 0x4030:001 (P830.01). 475 	
	0 Skip step	
0x4030:012 (P830.12)	Sequence 1: Step 12 (Sequence 1: Step 12) <ul style="list-style-type: none"> For further possible settings, see parameter 0x4030:001 (P830.01). 475 	
	0 Skip step	
0x4030:013 (P830.13)	Sequence 1: Step 13 (Sequence 1: Step 13) <ul style="list-style-type: none"> For further possible settings, see parameter 0x4030:001 (P830.01). 475 	
	0 Skip step	
0x4030:014 (P830.14)	Sequence 1: Step 14 (Sequence 1: Step 14) <ul style="list-style-type: none"> For further possible settings, see parameter 0x4030:001 (P830.01). 475 	
	0 Skip step	
0x4030:015 (P830.15)	Sequence 1: Step 15 (Sequence 1: Step 15) <ul style="list-style-type: none"> For further possible settings, see parameter 0x4030:001 (P830.01). 475 	
	0 Skip step	
0x4030:016 (P830.16)	Sequence 1: Step 16 (Sequence 1: Step 16) <ul style="list-style-type: none"> For further possible settings, see parameter 0x4030:001 (P830.01). 475 	
	0 Skip step	
0x4031 (P831.00)	Number of cycles sequence 1 (Cycl. sequence 1) 1 ... [1] ... 65535 <ul style="list-style-type: none"> From version 03.00 	Definition of how often the sequence 1 is to be passed through. <ul style="list-style-type: none"> 1 = one pass, 2 = two passes, ... 65535 = infinite number of cycles.



Sequencer

Sequence configuration

Parameter	Name / value range / [default setting]	Info
0x4032:001 (P835.01)	Sequence 2: Step 1 (Sequence 2: Step 1)	Configuration of the steps 1 ... 16 for sequence 2. <ul style="list-style-type: none"> Alternatively to calling a single segment, a complete sequence (with a higher number) can also be called from one step. This, for instance, serves to configure a main sequence from which several subsequences are called successively. With the setting "0", the respective step is skipped.
	-8 Sequence 8	
	-7 Sequence 7	
	-6 Sequence 6	
	-5 Sequence 5	
	-4 Sequence 4	
	-3 Sequence 3	
	0 Skip step	
	1 Segment 1	
	2 Segment 2	
	3 Segment 3	
	4 Segment 4	
	5 Segment 5	
	6 Segment 6	
7 Segment 7		
8 Segment 8		
0x4032:002 (P835.02)	Sequence 2: Step 2 (Sequence 2: Step 2)	<ul style="list-style-type: none"> For further possible settings, see parameter 0x4032:001 (P835.01). 477
	0 Skip step	
0x4032:003 (P835.03)	Sequence 2: Step 3 (Sequence 2: Step 3)	<ul style="list-style-type: none"> For further possible settings, see parameter 0x4032:001 (P835.01). 477
	0 Skip step	
0x4032:004 (P835.04)	Sequence 2: Step 4 (Sequence 2: Step 4)	<ul style="list-style-type: none"> For further possible settings, see parameter 0x4032:001 (P835.01). 477
	0 Skip step	
0x4032:005 (P835.05)	Sequence 2: Step 5 (Sequence 2: Step 5)	<ul style="list-style-type: none"> For further possible settings, see parameter 0x4032:001 (P835.01). 477
	0 Skip step	
0x4032:006 (P835.06)	Sequence 2: Step 6 (Sequence 2: Step 6)	<ul style="list-style-type: none"> For further possible settings, see parameter 0x4032:001 (P835.01). 477
	0 Skip step	
0x4032:007 (P835.07)	Sequence 2: Step 7 (Sequence 2: Step 7)	<ul style="list-style-type: none"> For further possible settings, see parameter 0x4032:001 (P835.01). 477
	0 Skip step	
0x4032:008 (P835.08)	Sequence 2: Step 8 (Sequence 2: Step 8)	<ul style="list-style-type: none"> For further possible settings, see parameter 0x4032:001 (P835.01). 477
	0 Skip step	
0x4032:009 (P835.09)	Sequence 2: Step 9 (Sequence 2: Step 9)	<ul style="list-style-type: none"> For further possible settings, see parameter 0x4032:001 (P835.01). 477
	0 Skip step	

Sequencer

Sequence configuration



Parameter	Name / value range / [default setting]	Info	
0x4032:010 (P835.10)	Sequence 2: Step 10 (Sequence 2: Step 10) • For further possible settings, see parameter 0x4032:001 (P835.01) . 477		
	0 Skip step		
0x4032:011 (P835.11)	Sequence 2: Step 11 (Sequence 2: Step 11) • For further possible settings, see parameter 0x4032:001 (P835.01) . 477		
	0 Skip step		
0x4032:012 (P835.12)	Sequence 2: Step 12 (Sequence 2: Step 12) • For further possible settings, see parameter 0x4032:001 (P835.01) . 477		
	0 Skip step		
0x4032:013 (P835.13)	Sequence 2: Step 13 (Sequence 2: Step 13) • For further possible settings, see parameter 0x4032:001 (P835.01) . 477		
	0 Skip step		
0x4032:014 (P835.14)	Sequence 2: Step 14 (Sequence 2: Step 14) • For further possible settings, see parameter 0x4032:001 (P835.01) . 477		
	0 Skip step		
0x4032:015 (P835.15)	Sequence 2: Step 15 (Sequence 2: Step 15) • For further possible settings, see parameter 0x4032:001 (P835.01) . 477		
	0 Skip step		
0x4032:016 (P835.16)	Sequence 2: Step 16 (Sequence 2: Step 16) • For further possible settings, see parameter 0x4032:001 (P835.01) . 477		
	0 Skip step		
0x4033 (P836.00)	Number of cycles sequence 2 (Cycl. sequence 2) 1 ... [1] ... 65535 • From version 03.00		Definition of how often the sequence 2 is to be passed through. • 1 = one pass, 2 = two passes, ... • 65535 = infinite number of cycles.
0x4034:001 (P840.01)	Sequence 3: Step 1 (Sequence 3: Step 1)		Configuration of the steps 1 ... 16 for sequence 3. • Alternatively to calling a single segment, a complete sequence (with a higher number) can also be called from one step. This, for instance, serves to configure a main sequence from which several subsequences are called successively. • With the setting "0", the respective step is skipped.
	-8 Sequence 8		
	-7 Sequence 7		
	-6 Sequence 6		
	-5 Sequence 5		
	-4 Sequence 4		
	0 Skip step		
	1 Segment 1		
	2 Segment 2		
	3 Segment 3		
	4 Segment 4		
5 Segment 5			
6 Segment 6			
7 Segment 7			
8 Segment 8			
0x4034:002 (P840.02)	Sequence 3: Step 2 (Sequence 3: Step 2) • For further possible settings, see parameter 0x4034:001 (P840.01) . 478		
	0 Skip step		



Parameter	Name / value range / [default setting]	Info
0x4034:003 (P840.03)	Sequence 3: Step 3 (Sequence 3: Step 3) • For further possible settings, see parameter 0x4034:001 (P840.01) . 478	
	0 Skip step	
0x4034:004 (P840.04)	Sequence 3: Step 4 (Sequence 3: Step 4) • For further possible settings, see parameter 0x4034:001 (P840.01) . 478	
	0 Skip step	
0x4034:005 (P840.05)	Sequence 3: Step 5 (Sequence 3: Step 5) • For further possible settings, see parameter 0x4034:001 (P840.01) . 478	
	0 Skip step	
0x4034:006 (P840.06)	Sequence 3: Step 6 (Sequence 3: Step 6) • For further possible settings, see parameter 0x4034:001 (P840.01) . 478	
	0 Skip step	
0x4034:007 (P840.07)	Sequence 3: Step 7 (Sequence 3: Step 7) • For further possible settings, see parameter 0x4034:001 (P840.01) . 478	
	0 Skip step	
0x4034:008 (P840.08)	Sequence 3: Step 8 (Sequence 3: Step 8) • For further possible settings, see parameter 0x4034:001 (P840.01) . 478	
	0 Skip step	
0x4034:009 (P840.09)	Sequence 3: Step 9 (Sequence 3: Step 9) • For further possible settings, see parameter 0x4034:001 (P840.01) . 478	
	0 Skip step	
0x4034:010 (P840.10)	Sequence 3: Step 10 (Sequence 3: Step 10) • For further possible settings, see parameter 0x4034:001 (P840.01) . 478	
	0 Skip step	
0x4034:011 (P840.11)	Sequence 3: Step 11 (Sequence 3: Step 11) • For further possible settings, see parameter 0x4034:001 (P840.01) . 478	
	0 Skip step	
0x4034:012 (P840.12)	Sequence 3: Step 12 (Sequence 3: Step 12) • For further possible settings, see parameter 0x4034:001 (P840.01) . 478	
	0 Skip step	
0x4034:013 (P840.13)	Sequence 3: Step 13 (Sequence 3: Step 13) • For further possible settings, see parameter 0x4034:001 (P840.01) . 478	
	0 Skip step	
0x4034:014 (P840.14)	Sequence 3: Step 14 (Sequence 3: Step 14) • For further possible settings, see parameter 0x4034:001 (P840.01) . 478	
	0 Skip step	

Sequencer

Sequence configuration



Parameter	Name / value range / [default setting]	Info	
0x4034:015 (P840.15)	Sequence 3: Step 15 (Sequence 3: Step 15) • For further possible settings, see parameter 0x4034:001 (P840.01) . 📄 478		
	0 Skip step		
0x4034:016 (P840.16)	Sequence 3: Step 16 (Sequence 3: Step 16) • For further possible settings, see parameter 0x4034:001 (P840.01) . 📄 478		
	0 Skip step		
0x4035 (P841.00)	Number of cycles sequence 3 (Cycl. sequence 3) 1 ... [1] ... 65535 • From version 03.00		Definition of how often the sequence 3 is to be passed through. • 1 = one pass, 2 = two passes, ... • 65535 = infinite number of cycles.
0x4036:001 (P845.01)	Sequence 4: Step 1 (Sequence 4: Step 1)		Configuration of the steps 1 ... 16 for sequence 4. • Alternatively to calling a single segment, a complete sequence (with a higher number) can also be called from one step. This, for instance, serves to configure a main sequence from which several subsequences are called successively. • With the setting "0", the respective step is skipped.
	-8 Sequence 8		
	-7 Sequence 7		
	-6 Sequence 6		
	-5 Sequence 5		
	0 Skip step		
	1 Segment 1		
	2 Segment 2		
	3 Segment 3		
	4 Segment 4		
	5 Segment 5		
6 Segment 6			
7 Segment 7			
8 Segment 8			
0x4036:002 (P845.02)	Sequence 4: Step 2 (Sequence 4: Step 2) • For further possible settings, see parameter 0x4036:001 (P845.01) . 📄 480		
	0 Skip step		
0x4036:003 (P845.03)	Sequence 4: Step 3 (Sequence 4: Step 3) • For further possible settings, see parameter 0x4036:001 (P845.01) . 📄 480		
	0 Skip step		
0x4036:004 (P845.04)	Sequence 4: Step 4 (Sequence 4: Step 4) • For further possible settings, see parameter 0x4036:001 (P845.01) . 📄 480		
	0 Skip step		
0x4036:005 (P845.05)	Sequence 4: Step 5 (Sequence 4: Step 5) • For further possible settings, see parameter 0x4036:001 (P845.01) . 📄 480		
	0 Skip step		
0x4036:006 (P845.06)	Sequence 4: Step 6 (Sequence 4: Step 6) • For further possible settings, see parameter 0x4036:001 (P845.01) . 📄 480		
	0 Skip step		
0x4036:007 (P845.07)	Sequence 4: Step 7 (Sequence 4: Step 7) • For further possible settings, see parameter 0x4036:001 (P845.01) . 📄 480		
	0 Skip step		



Parameter	Name / value range / [default setting]	Info
0x4036:008 (P845.08)	Sequence 4: Step 8 (Sequence 4: Step 8) <ul style="list-style-type: none"> For further possible settings, see parameter 0x4036:001 (P845.01). 📄 480 	
	0 Skip step	
0x4036:009 (P845.09)	Sequence 4: Step 9 (Sequence 4: Step 9) <ul style="list-style-type: none"> For further possible settings, see parameter 0x4036:001 (P845.01). 📄 480 	
	0 Skip step	
0x4036:010 (P845.10)	Sequence 4: Step 10 (Sequence 4: Step 10) <ul style="list-style-type: none"> For further possible settings, see parameter 0x4036:001 (P845.01). 📄 480 	
	0 Skip step	
0x4036:011 (P845.11)	Sequence 4: Step 11 (Sequence 4: Step 11) <ul style="list-style-type: none"> For further possible settings, see parameter 0x4036:001 (P845.01). 📄 480 	
	0 Skip step	
0x4036:012 (P845.12)	Sequence 4: Step 12 (Sequence 4: Step 12) <ul style="list-style-type: none"> For further possible settings, see parameter 0x4036:001 (P845.01). 📄 480 	
	0 Skip step	
0x4036:013 (P845.13)	Sequence 4: Step 13 (Sequence 4: Step 13) <ul style="list-style-type: none"> For further possible settings, see parameter 0x4036:001 (P845.01). 📄 480 	
	0 Skip step	
0x4036:014 (P845.14)	Sequence 4: Step 14 (Sequence 4: Step 14) <ul style="list-style-type: none"> For further possible settings, see parameter 0x4036:001 (P845.01). 📄 480 	
	0 Skip step	
0x4036:015 (P845.15)	Sequence 4: Step 15 (Sequence 4: Step 15) <ul style="list-style-type: none"> For further possible settings, see parameter 0x4036:001 (P845.01). 📄 480 	
	0 Skip step	
0x4036:016 (P845.16)	Sequence 4: Step 16 (Sequence 4: Step 16) <ul style="list-style-type: none"> For further possible settings, see parameter 0x4036:001 (P845.01). 📄 480 	
	0 Skip step	
0x4037 (P846.00)	Number of cycles sequence 4 (Cycl. sequence 4) 1 ... [1] ... 65535 <ul style="list-style-type: none"> From version 03.00 	Definition of how often the sequence 4 is to be passed through. <ul style="list-style-type: none"> 1 = one pass, 2 = two passes, ... 65535 = infinite number of cycles.

Sequencer

Sequence configuration



Parameter	Name / value range / [default setting]	Info
0x4038:001 (P850.01)	Sequence 5: Step 1 (Sequence 5: Step 1)	Configuration of the steps 1 ... 16 for sequence 5. <ul style="list-style-type: none"> • Alternatively to calling a single segment, a complete sequence (with a higher number) can also be called from one step. This, for instance, serves to configure a main sequence from which several subsequences are called successively. • With the setting "0", the respective step is skipped.
	-8 Sequence 8	
	-7 Sequence 7	
	-6 Sequence 6	
	0 Skip step	
	1 Segment 1	
	2 Segment 2	
	3 Segment 3	
	4 Segment 4	
	5 Segment 5	
6 Segment 6		
7 Segment 7		
8 Segment 8		
0x4038:002 (P850.02)	Sequence 5: Step 2 (Sequence 5: Step 2)	<ul style="list-style-type: none"> • For further possible settings, see parameter 0x4038:001 (P850.01). 482
	0 Skip step	
0x4038:003 (P850.03)	Sequence 5: Step 3 (Sequence 5: Step 3)	<ul style="list-style-type: none"> • For further possible settings, see parameter 0x4038:001 (P850.01). 482
	0 Skip step	
0x4038:004 (P850.04)	Sequence 5: Step 4 (Sequence 5: Step 4)	<ul style="list-style-type: none"> • For further possible settings, see parameter 0x4038:001 (P850.01). 482
	0 Skip step	
0x4038:005 (P850.05)	Sequence 5: Step 5 (Sequence 5: Step 5)	<ul style="list-style-type: none"> • For further possible settings, see parameter 0x4038:001 (P850.01). 482
	0 Skip step	
0x4038:006 (P850.06)	Sequence 5: Step 6 (Sequence 5: Step 6)	<ul style="list-style-type: none"> • For further possible settings, see parameter 0x4038:001 (P850.01). 482
	0 Skip step	
0x4038:007 (P850.07)	Sequence 5: Step 7 (Sequence 5: Step 7)	<ul style="list-style-type: none"> • For further possible settings, see parameter 0x4038:001 (P850.01). 482
	0 Skip step	
0x4038:008 (P850.08)	Sequence 5: Step 8 (Sequence 5: Step 8)	<ul style="list-style-type: none"> • For further possible settings, see parameter 0x4038:001 (P850.01). 482
	0 Skip step	
0x4038:009 (P850.09)	Sequence 5: Step 9 (Sequence 5: Step 9)	<ul style="list-style-type: none"> • For further possible settings, see parameter 0x4038:001 (P850.01). 482
	0 Skip step	
0x4038:010 (P850.10)	Sequence 5: Step 10 (Sequence 5: Step 10)	<ul style="list-style-type: none"> • For further possible settings, see parameter 0x4038:001 (P850.01). 482
	0 Skip step	



Parameter	Name / value range / [default setting]	Info	
0x4038:011 (P850.11)	Sequence 5: Step 11 (Sequence 5: Step 11) • For further possible settings, see parameter 0x4038:001 (P850.01) . 482		
	0 Skip step		
0x4038:012 (P850.12)	Sequence 5: Step 12 (Sequence 5: Step 12) • For further possible settings, see parameter 0x4038:001 (P850.01) . 482		
	0 Skip step		
0x4038:013 (P850.13)	Sequence 5: Step 13 (Sequence 5: Step 13) • For further possible settings, see parameter 0x4038:001 (P850.01) . 482		
	0 Skip step		
0x4038:014 (P850.14)	Sequence 5: Step 14 (Sequence 5: Step 14) • For further possible settings, see parameter 0x4038:001 (P850.01) . 482		
	0 Skip step		
0x4038:015 (P850.15)	Sequence 5: Step 15 (Sequence 5: Step 15) • For further possible settings, see parameter 0x4038:001 (P850.01) . 482		
	0 Skip step		
0x4038:016 (P850.16)	Sequence 5: Step 16 (Sequence 5: Step 16) • For further possible settings, see parameter 0x4038:001 (P850.01) . 482		
	0 Skip step		
0x4039 (P851.00)	Number of cycles sequence 5 (Cycl. sequence 5) 1 ... [1] ... 65535 • From version 03.00		Definition of how often the sequence 5 is to be passed through. • 1 = one pass, 2 = two passes, ... • 65535 = infinite number of cycles.
0x403A:001 (P855.01)	Sequence 6: Step 1 (Sequence 6: Step 1)		Configuration of the steps 1 ... 16 for sequence 6. • Alternatively to calling a single segment, a complete sequence (with a higher number) can also be called from one step. This, for instance, serves to configure a main sequence from which several subsequences are called successively. • With the setting "0", the respective step is skipped.
	-8 Sequence 8		
	-7 Sequence 7		
	0 Skip step		
	1 Segment 1		
	2 Segment 2		
	3 Segment 3		
	4 Segment 4		
	5 Segment 5		
	6 Segment 6		
	7 Segment 7		
8 Segment 8			
0x403A:002 (P855.02)	Sequence 6: Step 2 (Sequence 6: Step 2) • For further possible settings, see parameter 0x403A:001 (P855.01) . 483		
	0 Skip step		
0x403A:003 (P855.03)	Sequence 6: Step 3 (Sequence 6: Step 3) • For further possible settings, see parameter 0x403A:001 (P855.01) . 483		
	0 Skip step		

Sequencer

Sequence configuration



Parameter	Name / value range / [default setting]	Info
0x403A:004 (P855.04)	Sequence 6: Step 4 (Sequence 6: Step 4) • For further possible settings, see parameter 0x403A:001 (P855.01) . □ 483	
	0 Skip step	
0x403A:005 (P855.05)	Sequence 6: Step 5 (Sequence 6: Step 5) • For further possible settings, see parameter 0x403A:001 (P855.01) . □ 483	
	0 Skip step	
0x403A:006 (P855.06)	Sequence 6: Step 6 (Sequence 6: Step 6) • For further possible settings, see parameter 0x403A:001 (P855.01) . □ 483	
	0 Skip step	
0x403A:007 (P855.07)	Sequence 6: Step 7 (Sequence 6: Step 7) • For further possible settings, see parameter 0x403A:001 (P855.01) . □ 483	
	0 Skip step	
0x403A:008 (P855.08)	Sequence 6: Step 8 (Sequence 6: Step 8) • For further possible settings, see parameter 0x403A:001 (P855.01) . □ 483	
	0 Skip step	
0x403A:009 (P855.09)	Sequence 6: Step 9 (Sequence 6: Step 9) • For further possible settings, see parameter 0x403A:001 (P855.01) . □ 483	
	0 Skip step	
0x403A:010 (P855.10)	Sequence 6: Step 10 (Sequence 6: Step 10) • For further possible settings, see parameter 0x403A:001 (P855.01) . □ 483	
	0 Skip step	
0x403A:011 (P855.11)	Sequence 6: Step 11 (Sequence 6: Step 11) • For further possible settings, see parameter 0x403A:001 (P855.01) . □ 483	
	0 Skip step	
0x403A:012 (P855.12)	Sequence 6: Step 12 (Sequence 6: Step 12) • For further possible settings, see parameter 0x403A:001 (P855.01) . □ 483	
	0 Skip step	
0x403A:013 (P855.13)	Sequence 6: Step 13 (Sequence 6: Step 13) • For further possible settings, see parameter 0x403A:001 (P855.01) . □ 483	
	0 Skip step	
0x403A:014 (P855.14)	Sequence 6: Step 14 (Sequence 6: Step 14) • For further possible settings, see parameter 0x403A:001 (P855.01) . □ 483	
	0 Skip step	
0x403A:015 (P855.15)	Sequence 6: Step 15 (Sequence 6: Step 15) • For further possible settings, see parameter 0x403A:001 (P855.01) . □ 483	
	0 Skip step	



Sequencer

Sequence configuration

Parameter	Name / value range / [default setting]	Info
0x403A:016 (P855.16)	Sequence 6: Step 16 (Sequence 6: Step 16) • For further possible settings, see parameter 0x403A:001 (P855.01) . □ 483	
	0 Skip step	
0x403B (P856.00)	Number of cycles sequence 6 (Cycl. sequence 6) 1 ... [1] ... 65535 • From version 03.00	Definition of how often the sequence 6 is to be passed through. • 1 = one pass, 2 = two passes, ... • 65535 = infinite number of cycles.
0x403C:001 (P860.01)	Sequence 7: Step 1 (Sequence 7: Step 1)	Configuration of the steps 1 ... 16 for sequence 7. • Alternatively to calling a single segment, a complete sequence (with a higher number) can also be called from one step. This, for instance, serves to configure a main sequence from which several subsequences are called successively. • With the setting "0", the respective step is skipped.
	-8 Sequence 8	
	0 Skip step	
	1 Segment 1	
	2 Segment 2	
	3 Segment 3	
	4 Segment 4	
	5 Segment 5	
	6 Segment 6	
	7 Segment 7	
8 Segment 8		
0x403C:002 (P860.02)	Sequence 7: Step 2 (Sequence 7: Step 2) • For further possible settings, see parameter 0x403C:001 (P860.01) . □ 485	
	0 Skip step	
0x403C:003 (P860.03)	Sequence 7: Step 3 (Sequence 7: Step 3) • For further possible settings, see parameter 0x403C:001 (P860.01) . □ 485	
	0 Skip step	
0x403C:004 (P860.04)	Sequence 7: Step 4 (Sequence 7: Step 4) • For further possible settings, see parameter 0x403C:001 (P860.01) . □ 485	
	0 Skip step	
0x403C:005 (P860.05)	Sequence 7: Step 5 (Sequence 7: Step 5) • For further possible settings, see parameter 0x403C:001 (P860.01) . □ 485	
	0 Skip step	
0x403C:006 (P860.06)	Sequence 7: Step 6 (Sequence 7: Step 6) • For further possible settings, see parameter 0x403C:001 (P860.01) . □ 485	
	0 Skip step	
0x403C:007 (P860.07)	Sequence 7: Step 7 (Sequence 7: Step 7) • For further possible settings, see parameter 0x403C:001 (P860.01) . □ 485	
	0 Skip step	
0x403C:008 (P860.08)	Sequence 7: Step 8 (Sequence 7: Step 8) • For further possible settings, see parameter 0x403C:001 (P860.01) . □ 485	
	0 Skip step	

Sequencer

Sequence configuration



Parameter	Name / value range / [default setting]	Info
0x403C:009 (P860.09)	Sequence 7: Step 9 (Sequence 7: Step 9) • For further possible settings, see parameter 0x403C:001 (P860.01) . □ 485	
	0 Skip step	
0x403C:010 (P860.10)	Sequence 7: Step 10 (Sequence 7: Step 10) • For further possible settings, see parameter 0x403C:001 (P860.01) . □ 485	
	0 Skip step	
0x403C:011 (P860.11)	Sequence 7: Step 11 (Sequence 7: Step 11) • For further possible settings, see parameter 0x403C:001 (P860.01) . □ 485	
	0 Skip step	
0x403C:012 (P860.12)	Sequence 7: Step 12 (Sequence 7: Step 12) • For further possible settings, see parameter 0x403C:001 (P860.01) . □ 485	
	0 Skip step	
0x403C:013 (P860.13)	Sequence 7: Step 13 (Sequence 7: Step 13) • For further possible settings, see parameter 0x403C:001 (P860.01) . □ 485	
	0 Skip step	
0x403C:014 (P860.14)	Sequence 7: Step 14 (Sequence 7: Step 14) • For further possible settings, see parameter 0x403C:001 (P860.01) . □ 485	
	0 Skip step	
0x403C:015 (P860.15)	Sequence 7: Step 15 (Sequence 7: Step 15) • For further possible settings, see parameter 0x403C:001 (P860.01) . □ 485	
	0 Skip step	
0x403C:016 (P860.16)	Sequence 7: Step 16 (Sequence 7: Step 16) • For further possible settings, see parameter 0x403C:001 (P860.01) . □ 485	
	0 Skip step	
0x403D (P861.00)	Number of cycles sequence 7 (Cycl. sequence 7) 1 ... [1] ... 65535 • From version 03.00	Definition of how often the sequence 7 is to be passed through. • 1 = one pass, 2 = two passes, ... • 65535 = infinite number of cycles.
0x403E:001 (P865.01)	Sequence 8: Step 1 (Sequence 8: Step 1)	Configuration of the steps 1 ... 16 for sequence 8. • With the setting "0", the respective step is skipped.
	0 Skip step	
	1 Segment 1	
	2 Segment 2	
	3 Segment 3	
	4 Segment 4	
	5 Segment 5	
	6 Segment 6	
	7 Segment 7	
8 Segment 8		
0x403E:002 (P865.02)	Sequence 8: Step 2 (Sequence 8: Step 2) • For further possible settings, see parameter 0x403E:001 (P865.01) . □ 486	
	0 Skip step	



Parameter	Name / value range / [default setting]	Info
0x403E:003 (P865.03)	Sequence 8: Step 3 (Sequence 8: Step 3) • For further possible settings, see parameter 0x403E:001 (P865.01) . 486	
	0 Skip step	
0x403E:004 (P865.04)	Sequence 8: Step 4 (Sequence 8: Step 4) • For further possible settings, see parameter 0x403E:001 (P865.01) . 486	
	0 Skip step	
0x403E:005 (P865.05)	Sequence 8: Step 5 (Sequence 8: Step 5) • For further possible settings, see parameter 0x403E:001 (P865.01) . 486	
	0 Skip step	
0x403E:006 (P865.06)	Sequence 8: Step 6 (Sequence 8: Step 6) • For further possible settings, see parameter 0x403E:001 (P865.01) . 486	
	0 Skip step	
0x403E:007 (P865.07)	Sequence 8: Step 7 (Sequence 8: Step 7) • For further possible settings, see parameter 0x403E:001 (P865.01) . 486	
	0 Skip step	
0x403E:008 (P865.08)	Sequence 8: Step 8 (Sequence 8: Step 8) • For further possible settings, see parameter 0x403E:001 (P865.01) . 486	
	0 Skip step	
0x403E:009 (P865.09)	Sequence 8: Step 9 (Sequence 8: Step 9) • For further possible settings, see parameter 0x403E:001 (P865.01) . 486	
	0 Skip step	
0x403E:010 (P865.10)	Sequence 8: Step 10 (Sequence 8: Step 10) • For further possible settings, see parameter 0x403E:001 (P865.01) . 486	
	0 Skip step	
0x403E:011 (P865.11)	Sequence 8: Step 11 (Sequence 8: Step 11) • For further possible settings, see parameter 0x403E:001 (P865.01) . 486	
	0 Skip step	
0x403E:012 (P865.12)	Sequence 8: Step 12 (Sequence 8: Step 12) • For further possible settings, see parameter 0x403E:001 (P865.01) . 486	
	0 Skip step	
0x403E:013 (P865.13)	Sequence 8: Step 13 (Sequence 8: Step 13) • For further possible settings, see parameter 0x403E:001 (P865.01) . 486	
	0 Skip step	
0x403E:014 (P865.14)	Sequence 8: Step 14 (Sequence 8: Step 14) • For further possible settings, see parameter 0x403E:001 (P865.01) . 486	
	0 Skip step	

Sequencer

Sequence configuration

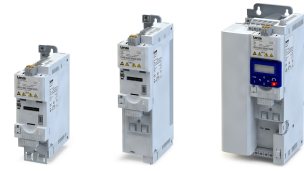

Parameter	Name / value range / [default setting]	Info
0x403E:015 (P865.15)	Sequence 8: Step 15 (Sequence 8: Step 15) <ul style="list-style-type: none"> For further possible settings, see parameter 0x403E:001 (P865.01). 486 	
	0 Skip step	
0x403E:016 (P865.16)	Sequence 8: Step 16 (Sequence 8: Step 16) <ul style="list-style-type: none"> For further possible settings, see parameter 0x403E:001 (P865.01). 486 	
	0 Skip step	
0x403F (P866.00)	Number of cycles sequence 8 (Cycl. sequence 8) 1 ... [1] ... 65535 <ul style="list-style-type: none"> From version 03.00 	Definition of how often the sequence 8 is to be passed through. <ul style="list-style-type: none"> 65535 = infinite number of cycles.



11.3 Sequencer basic settings

In the presetting, the sequencer is disabled. In order to enable the sequencer, the desired sequencer mode (time and/or step operation) must be set. Moreover, different end of sequence modes and start of sequences modes are available.

Details

Sequencer mode **0x4025 (P800.00)**

- The sequencer can be operated in time and/or step operation.
- The following diagram demonstrates the different sequencer modes:

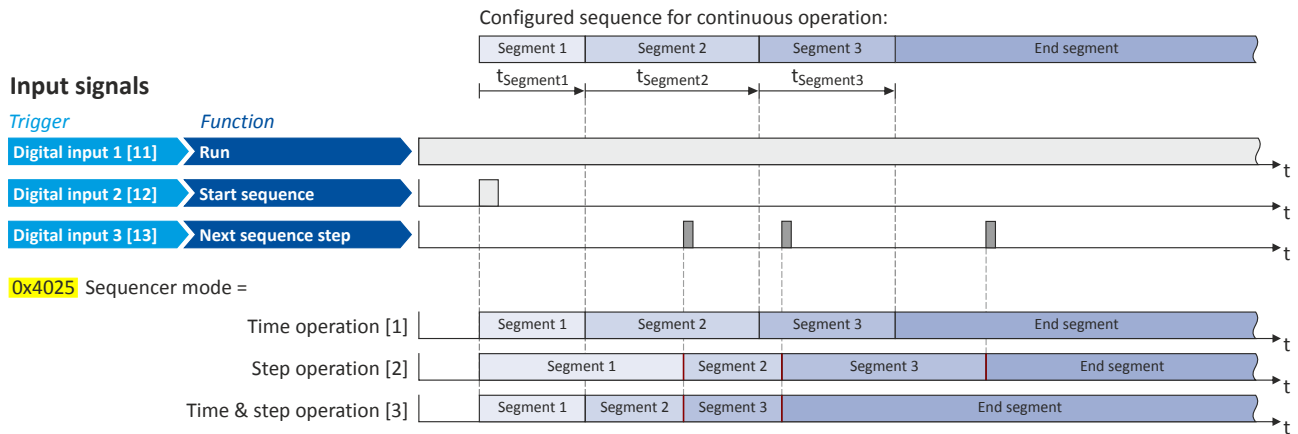

End of sequence mode **0x402F (P824.00)**

- The end of sequence mode defines the action after the end of the sequence.
- In the default setting "Keep running [0]", the setpoint set for the end segment is continuously transmitted to the motor control until the sequence is aborted.
- The following diagram demonstrates the different end of sequence modes:

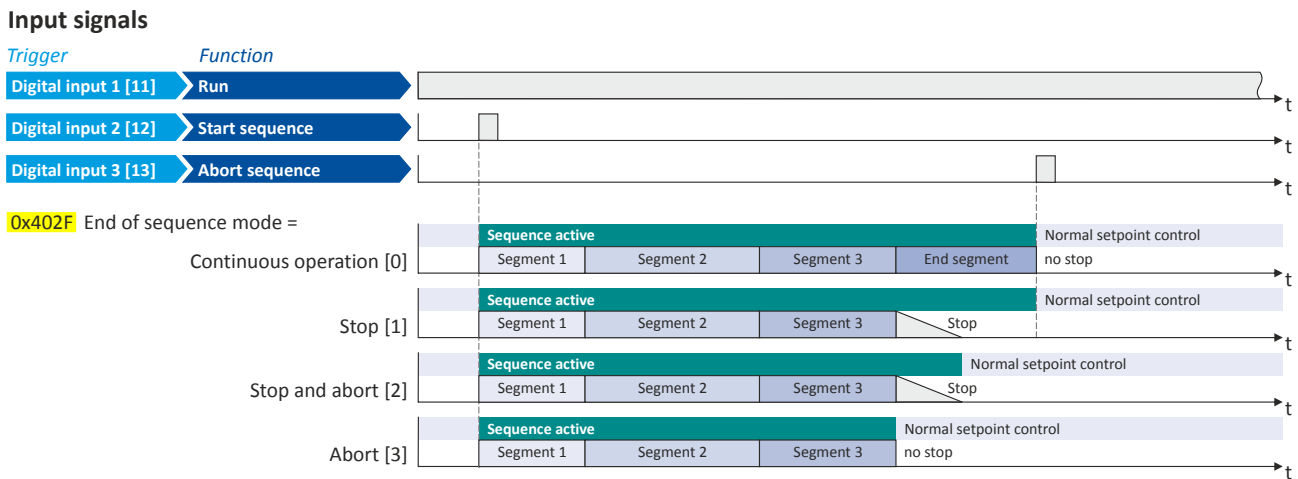

Sequencer

Sequencer basic settings

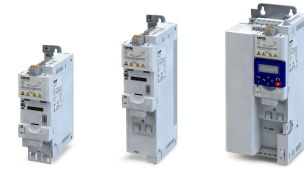

Start of sequence mode [0x4040 \(P820.00\)](#)

- The start of sequence mode defines the action after the motor is stopped and restarted or after the motor has been restarted after an error occurred.
- In the default setting "Restart sequencer [0]", the currently selected sequence is restarted.
- The following diagram demonstrates the different start of sequence modes:

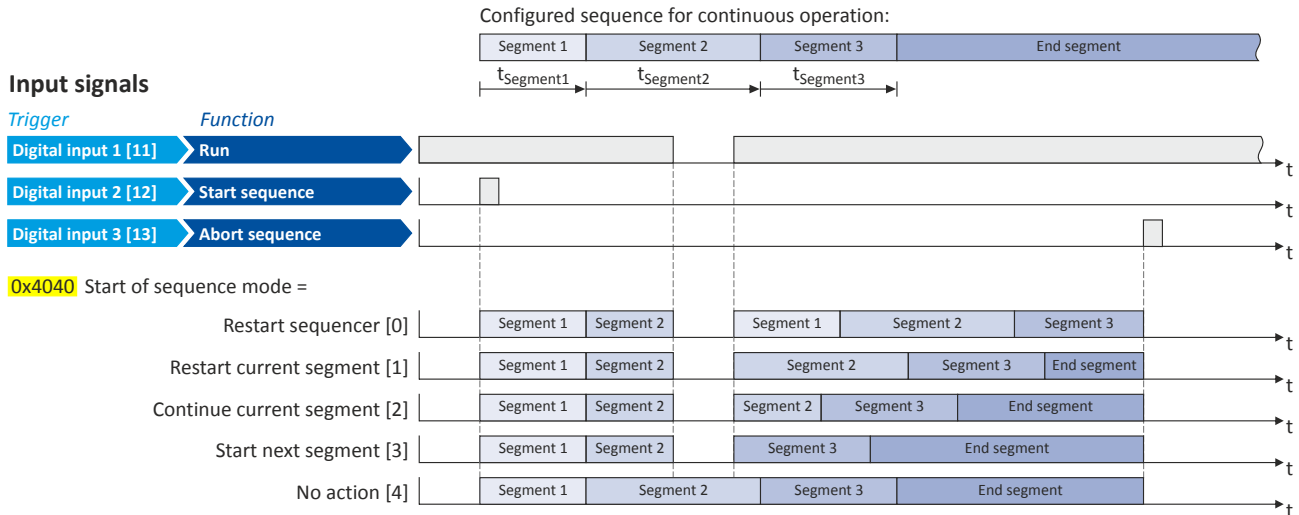

Parameter	Name / value range / [default setting]	Info
0x4025 (P800.00)	Sequencer mode (Sequencer mode) • From version 02.00	Selection of the sequencer mode.
	0 Disabled	
	1 Time operation (from version 03.00)	The switch-over to the next step of the sequence is made after the time set for the current segment has elapsed.
	2 Step operation (from version 03.00)	The switch-over to the next step of the sequence is made via the trigger assigned in 0x2631:032 (P400.32) to the "Next sequence step" function.
	3 Time & step operation (from version 03.00)	The switch-over to the next step of the sequence is made via the trigger assigned in 0x2631:032 (P400.32) to the "Next sequence step" function, but no later than after the time set for the current segment has elapsed.
0x402F (P824.00)	End of sequence mode (End of seq. mode) • From version 03.00	Selection of the action after the sequence has been completed, i. e., after the steps configured for the sequence have been passed through with the set numbers of cycles.
	0 Keep running	The setpoint set for the end segment is continuously transmitted to the motor control until the sequence is aborted.
	1 Stop	The motor is stopped with the stop method set in 0x2838:003 (P203.03) . The setpoint is continued to be controlled by the sequencer. In order to return to the normal setpoint control, the sequence must be aborted. Note! After returning to the normal setpoint control, a start command is required to restart the motor.
	2 Stop and abort	The motor is stopped with the stop method set in 0x2838:003 (P203.03) . After standstill is reached, it is automatically returned to the normal setpoint control. Note! After returning to the normal setpoint control, a start command is required to restart the motor.
	3 Abort	Return to the normal setpoint control without stopping the motor.



Sequencer

Sequencer basic settings

Parameter	Name / value range / [default setting]	Info
0x4040 (P820.00)	Start of sequence mode (StartOfSeq. mode) • From version 03.00	Selection of the action after the motor has been stopped and restarted or after the motor has been restarted after an error occurred.
	0 Restart sequencer	The currently selected sequence is restarted.
	1 Restart current segment	The current segment of the selected sequence is restarted.
	2 Continue current segment	The current segment of the selected sequence is continued (just like after a break).
	3 Start next segment	The next segment of the selected sequence is started.
	4 No action	For debugging purposes: The sequence is continued to be processed (including output states) even if the motor is stopped.

Related topics

▶ [Sequencer control functions](#) 559

▶ [Sequencer diagnostics](#) 109

Safety functions

Safe torque off (STO)

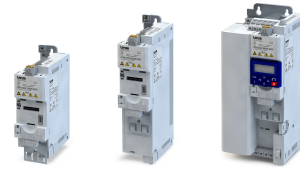

12 Safety functions

12.1 Safe torque off (STO)

With this safety function, the drive can be switch off safely immediately.

⚠ DANGER!

Automatic restart if the request of the safety function is deactivated.

Possible consequences: Death or severe injuries

- ▶ You must provide external measures according to EN ISO 13849–1 which ensure that the drive only restarts after a confirmation.

Preconditions

Inverter with I5MASA000 safety module

Details

Safe disconnection of the drive

1. A safety sensor requests the safety function.
2. The transmission of the pulse width modulation is safely switched off by the safety unit.
3. The power drivers do not generate a rotating field anymore.
4. The "STO is not active" status in the status word changes from 1: HIGH to 0: LOW (object 0x6041, bit 15).

The motor is safely switched to torqueless operation (STO).

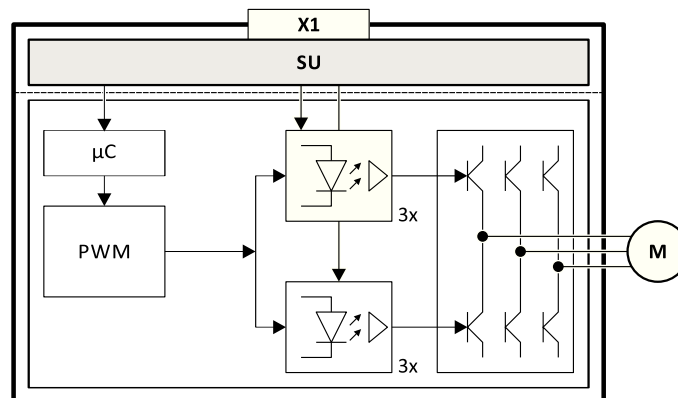

Fig. 8: Operating principle of safety unit

X1 Control terminals of the safety unit

M Motor

PWM Pulse width modulation

µC Microcontroller

Truth table

Safe input / channel		Inverter	
SIA	SIB	Device status	Approval
0	0	STO active	0
0	1		0
1	0		0
1	1	Drive enabled	1



If SIA = LOW or SIB = LOW, the internal status signal "Safe torque off (STO) active [55]" in the inverter is set to TRUE. This status signal can be used to trigger a "non-safe output" (e.g. the relay).



13 Flexible I/O configuration

Use parameter 0x2631 (P400xx) to individually adapt the inverter control to the respective application. This is basically effected by assigning digital signal sources ("triggers") to functions of the inverter.

i NOTICE

A digital signal source can be assigned to several functions.
 Possible consequence: unforeseeable behaviour of the drive in case of incorrect assignment
 ► Carry out assignment of a digital signal source to several functions with greater care.

Details

- Each subcode of 0x2631 (P400) is permanently assigned to a specific function. Functions are for example "Enable inverter", "Activate quick stop" or "Start forward (CW)".
- For a function, exactly one (digital) trigger can be set:



- Possible triggers to be selected are for example the digital input and internal status signals of the inverter.
- A list of all triggers available can be found in the description for the parameter [0x2631:001 \(P400.01\)](#).
- If the trigger condition is met, the corresponding function is executed. More details with regard to the respective trigger conditions can be gathered from the functional descriptions in the following subchapters.

Example: changing the function assignment of a digital input

Task for this example:

1. The preset assignment of the digital input 3 for "Invert rotation" function is to be cancelled.
2. Instead, the digital input 3 is to be assigned to the "Activate DC braking" function.

For this purpose, the following two settings are required:

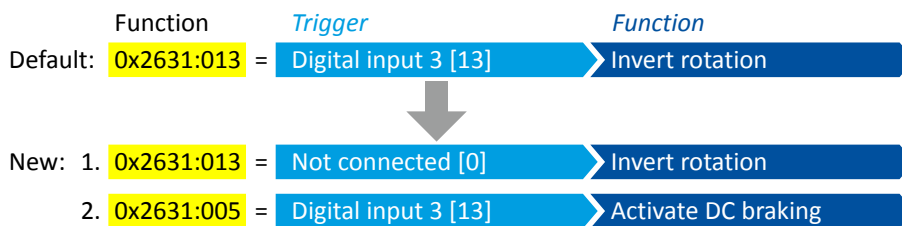

Flexible I/O configuration

Control source change-over



13.1 Control source change-over

The term "control sources" in this connection refers to the digital signal sources from which the inverter receives its start, stop, and reversal commands.

Possible control sources are:

- Digital inputs
- Keypad
- Network

Details

First, select in [0x2824 \(P200.00\)](#) whether the start of the motor is to be configured flexibly (default setting) or exclusively via the keypad. ▶ [Control source selection](#) [□ 121](#)

If "Flexible I/O configuration" is set, a change-over from one control source to another can be effected during operation via the functions listed in the following table. The inverter not only supports such a change-over via its digital inputs, but also as a function of internal inverter states.

Activate keypad control 0x2631:012 (P400.12)	Activate network control 0x2631:037 (P400.37)	Active control source
FALSE / Not connected	FALSE / Not connected	Flexible I/O configuration (default setting) <ul style="list-style-type: none"> • The motor is controlled via the digital inputs. • For preconfigured assignment of the digital inputs, see chapter "Function assignment of the inputs and outputs". □ 52 • For description of the basic functions for controlling the motor, see chapter "Start / stop motor". □ 499
FALSE / Not connected	TRUE	Network <ul style="list-style-type: none"> • Starting the motor is only possible via the network control word. • Exception: Jog operation; see chapter "Start / stop motor". □ 499 ▶ Example 2: Change-over from terminal control to network control □ 498
TRUE	Any	Keypad <ul style="list-style-type: none"> • Starting the motor is only possible via the  keypad key. • Exception: Jog operation; see chapter "Start / stop motor". □ 499 ▶ Example 1: Change-over from terminal control to keypad control □ 497

The following signal flow shows the internal control logics:

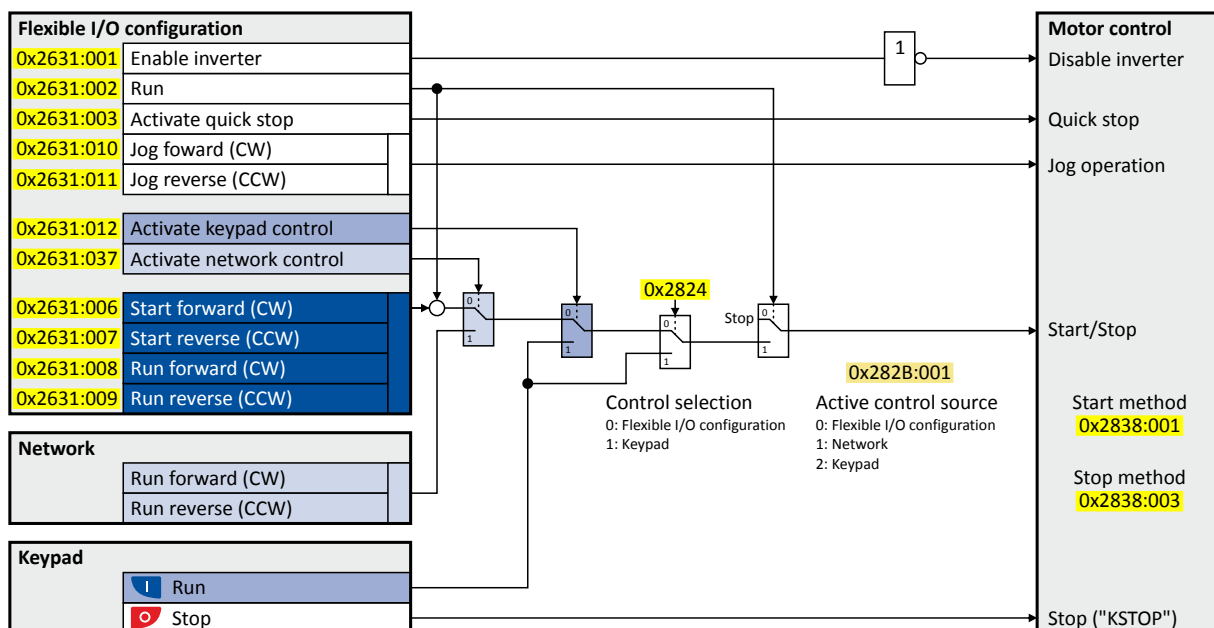



The "Enable inverter" [0x2631:001 \(P400.01\)](#) function must be set to TRUE to start the motor. Either via digital input or by default setting "Constant TRUE [1]". If the function is set to FALSE, the inverter is disabled. The motor becomes torqueless (coasts).

In case of an activated keypad or network control, the "Run" [0x2631:002 \(P400.02\)](#) function must be additionally set to TRUE to start the motor. Either via digital input or by the "Constant TRUE [1]" setting.

Notes:

- In case of an activated keypad or network control, the following functions are still active:
 - [0x2631:001 \(P400.01\)](#): Enable inverter
 - [0x2631:002 \(P400.02\)](#): Run
 - [0x2631:003 \(P400.03\)](#): Activate quick stop
 - [0x2631:004 \(P400.04\)](#): Reset fault
 - [0x2631:005 \(P400.05\)](#): Activate DC braking
 - [0x2631:010 \(P400.10\)](#): Jog forward (CW)
 - [0x2631:011 \(P400.11\)](#): Jog reverse (CCW)
 - [0x2631:012 \(P400.12\)](#): Activate keypad control
 - [0x2631:037 \(P400.37\)](#): Activate network control
- In case of an activated network control, the following additional functions are still active:
 - [0x2631:013 \(P400.13\)](#): Invert rotation
 - The functions for setpoint change-over. ▶ [Setpoint change-over](#) [514](#)

All other functions configurable via [0x2631:xx \(P400.xx\)](#) are deactivated in case of keypad or network control.

Diagnostic parameters:

- [0x282A:001 \(P126.01\)](#): Cause of disable
- [0x282A:002 \(P126.02\)](#): Cause of quick stop
- [0x282A:003 \(P126.03\)](#): Cause of stop
- [0x282B:001 \(P125.01\)](#): Active control source



For description of the basic functions for controlling the motor, see chapter "[Start / stop motor](#)". [499](#)

Parameter	Name / value range / [default setting]	Info
0x2631:012 (P400.12)	Function list: Activate keypad control (Function list: Keypad control) • For further possible settings, see parameter 0x2631:001 (P400.01) . 500	Assignment of a trigger for the "Activate keypad control" function. Trigger = TRUE: activate keypad as control source. Trigger = FALSE: no action / deactivate keypad as control source again.
	0 Not connected	No trigger assigned (trigger is constantly FALSE).
0x2631:037 (P400.37)	Function list: Activate network control (Function list: Network control) • For further possible settings, see parameter 0x2631:001 (P400.01) . 500	Assignment of a trigger for the "Activate network control" function. Trigger = TRUE: Activate network control. Trigger = FALSE: No action / deactivate network control again.
	0 Not connected	No trigger assigned (trigger is constantly FALSE).
	114 Network control active (from version 02.00)	TRUE if the network control is requested via bit 5 of the AC drive control word 0x400B:001 (P592.01) . Otherwise FALSE. Notes: • Set this selection if the network control is to be activated via bit 5 of the AC drive control word. • The AC drive control word can be used with any communication protocol. ▶ AC Drive Profile 221

Flexible I/O configuration

Control source change-over



Parameter	Name / value range / [default setting]	Info
0x2824 (P200.00)	Control selection (Control select.)	Selection of the type of inverter control.
	0 Flexible I/O configuration	<p>This selection enables a flexible assignment of the start, stop, and rotating direction commands with digital signal sources.</p> <ul style="list-style-type: none"> Digital signal sources can be digital inputs, network and keypad. The I/O configuration is made via the parameters 0x2631:xx (P400.xx).
	1 Keypad	<p>This selection enables the motor to be started exclusively via the start key of the keypad. Other signal sources for starting the motor are ignored.</p> <p> Start motor  Stop motor</p> <p>Note!</p> <ul style="list-style-type: none"> The functions "Enable inverter" 0x2631:001 (P400.01) and "Run" 0x2631:002 (P400.02) must be set to TRUE to start the motor. If jog operation is active, the motor cannot be stopped via the  keypad key.



Flexible I/O configuration

Control source change-over

Example 1: Change-over from terminal control to keypad control

13.1.1 Example 1: Change-over from terminal control to keypad control

- The control is executed primarily via the I/O terminals: Switch S1 serves to start and stop the motor.
- Switch S2 serves to optionally change over to local keypad control. In case of activated keypad control, the motor can only be started via the **I** keypad key. However, the condition is that switch S1 is closed.
- If switch S1 is opened again or the **o** keypad key is pressed, the motor is stopped (irrespective of the active control source).

Connection plan	function
	Potentiometer R1 Frequency setpoint selection
	Switch S1 Run
	Switch S2 Activate keypad control

Parameter	Name	Setting for this example
0x2631:001 (P400.01)	Enable inverter	Constant TRUE [1]
0x2631:002 (P400.02)	Run	Digital input 1 [11]
0x2631:004 (P400.04)	Reset fault	Not connected [0]
0x2631:012 (P400.12)	Activate keypad control	Digital input 2 [12]
0x2824 (P200.00)	Control selection	Flexible I/O configuration [0]

Input signals

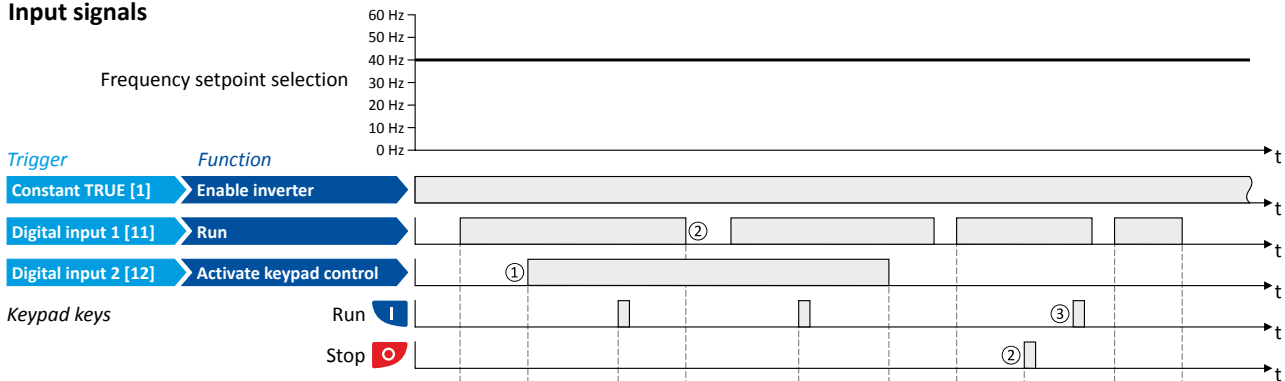

Output signals

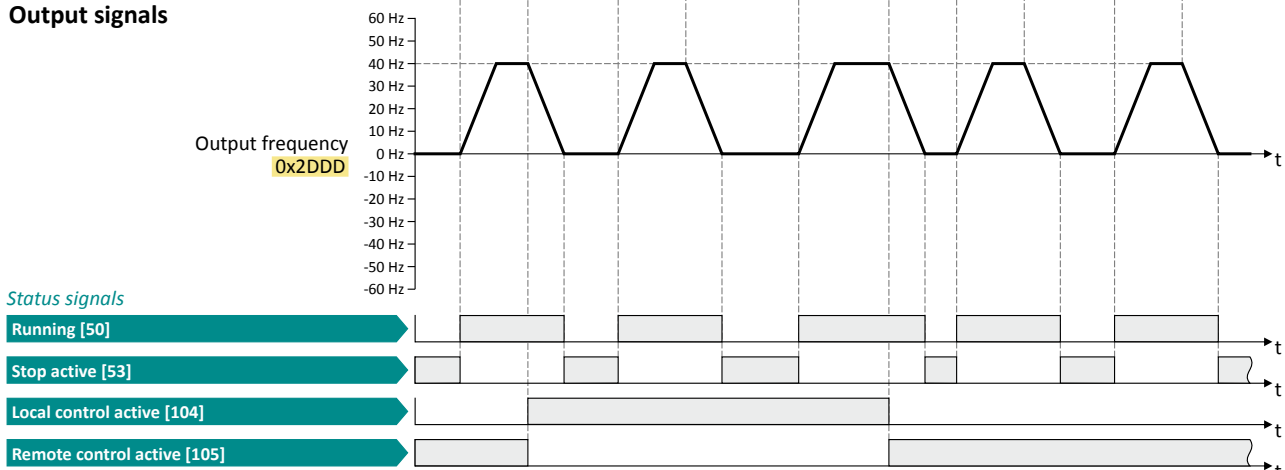

The status signals can be assigned to digital outputs. [► Configuration of digital outputs □ 574](#)

- When changing over to another control source, the motor is first stopped with the stop method set in [0x2838:003 \(P203.03\)](#).
- The motor will also be stopped if the "Run" function is deactivated or the **o** keypad key is pressed (irrespective of the active control source).
- After stopping with the **o** keypad key and before a renewed start command from another control source, the **I** key on the keypad must be pressed to cancel the keypad stop again ("KSTOP").

Flexible I/O configuration

Control source change-over

Example 2: Change-over from terminal control to network control

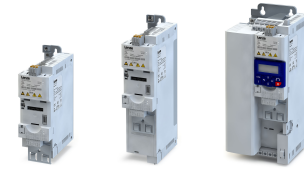

13.1.2 Example 2: Change-over from terminal control to network control

- The control is executed primarily via the I/O terminals: Switch S1 serves to start and stop the motor.
- Switch S2 serves to activate the network control. In case of activated keypad control, the motor can only be started via the network control word. However, the condition is that switch S1 is closed.
- If switch S1 is opened again, the motor is stopped (irrespective of the active control source).

Connection plan	function
	Potentiometer R1: Frequency setpoint selection
	Switch S1: Run
	Switch S2: Activate network control

Parameter	Name	Setting for this example
0x2631:001 (P400.01)	Enable inverter	Constant TRUE [1]
0x2631:002 (P400.02)	Run	Digital input 1 [11]
0x2631:004 (P400.04)	Reset fault	Not connected [0]
0x2631:037 (P400.37)	Activate network control	Digital input 2 [12]
0x2824 (P200.00)	Control selection	Flexible I/O configuration [0]

Input signals

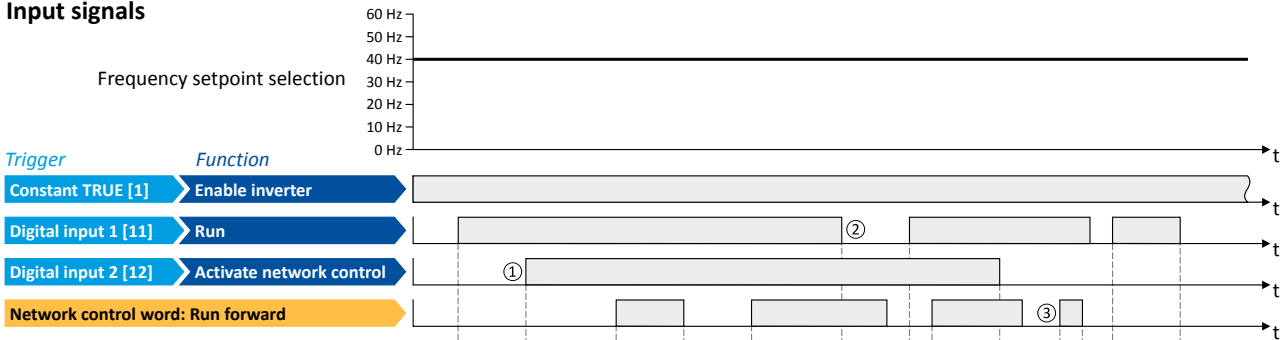

Output signals

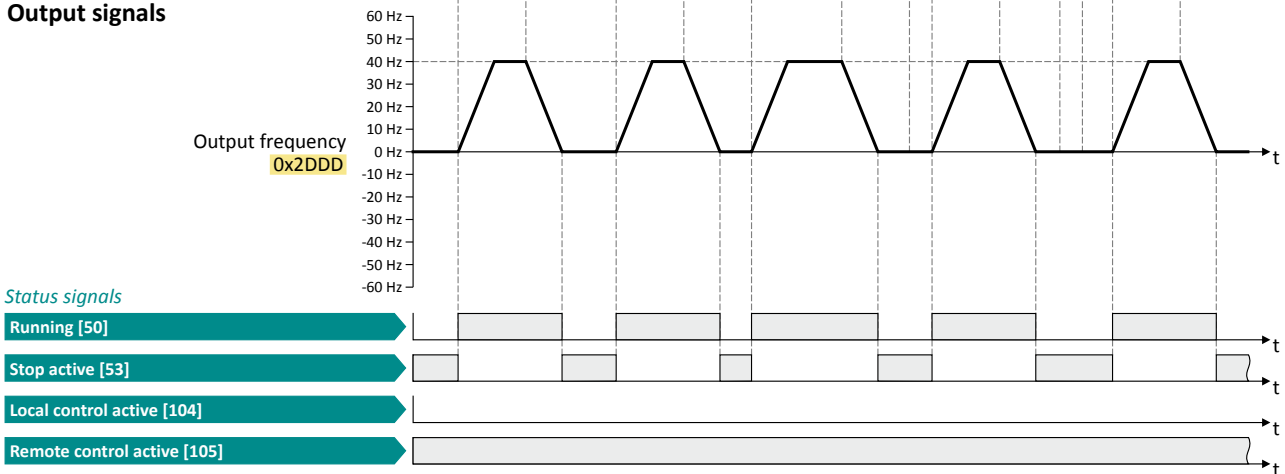

The status signals can be assigned to digital outputs. [► Configuration of digital outputs □ 574](#)

- ① When changing over to another control source, the motor is first stopped with the stop method set in [0x2838:003 \(P203.03\)](#).
- ② The motor will also be stopped if the "Run" function is deactivated (irrespective of the active control source).
- ③ Commands via network are ignored if the network control is not active.



13.2 Start / stop motor

Configuration of the triggers for the basic functions for controlling the motor.

Details

The following table contains a short overview of the basic functions. For more details see the following parameter descriptions.

function	Info
Enable inverter 0x2631:001 (P400.01)	<p>Enable/disable operation.</p> <ul style="list-style-type: none"> The function must be set to TRUE to start the motor. Either via digital input or by default setting "Constant TRUE [1]". If the function is set to FALSE, the inverter is disabled. The motor becomes torqueless (coasts). <p>▶ Example 6: Enable inverter 513</p>
Run 0x2631:002 (P400.02)	<p>Function 1: Start / stop motor (default setting)</p> <ul style="list-style-type: none"> Function 1 is active if no further start commands (start forward/start reverse) have been connected to triggers, no keypad control is active and no network control is active. <p>TRUE: Let motor rotate forward (CW). FALSE: Stop motor.</p> <p>▶ Example 1: Start/stop (1 signal) and reversal 505</p> <p>Function 2: Start enable/stop motor</p> <ul style="list-style-type: none"> Function 2 is active if further start commands have been connected to triggers, keypad control is active or network control is active. <p>TRUE: Start commands of the active control source are enabled. FALSE: Stop motor.</p> <p>▶ Example 2: Start forward/start reverse/stop (edge-controlled) 506 ▶ Example 3: Run forward/Run reverse/stop (status-controlled) 508</p>
Activate quick stop 0x2631:003 (P400.03)	<p>Bring motor to a standstill in best time.</p> <p>▶ Example 4: Quick stop 510</p>
Start forward (CW) 0x2631:006 (P400.06)	<p>Start motor edge-controlled.</p> <ul style="list-style-type: none"> In order to be able to start the motor, the "Run" function must be set to TRUE. The motor is stopped by resetting the "Run" function to FALSE. Functions are deactivated in case of keypad or network control. <p>▶ Example 2: Start forward/start reverse/stop (edge-controlled) 506</p>
Start reverse (CCW) 0x2631:007 (P400.07)	
Run forward (CW) 0x2631:008 (P400.08)	<p>Let the motor rotate in a status-controlled way.</p> <ul style="list-style-type: none"> In order to be able to start the motor, the "Run" function must be set to TRUE. Functions are deactivated in case of keypad or network control. <p>▶ Example 3: Run forward/Run reverse/stop (status-controlled) 508</p>
Run reverse (CCW) 0x2631:009 (P400.09)	
Jog forward (CW) 0x2631:010 (P400.10)	<p>Jog operation: Let the motor rotate in a status-controlled way with setpoint preset.</p> <p>⚠ CAUTION!</p> <p>The jog operation has a higher priority than the "Run" function, all other start commands and the keypad key .</p> <ul style="list-style-type: none"> If jog operation is active, the motor cannot be stopped with the previously mentioned functions! However, jog operation can be interrupted by the "Quick stop" function. Jog operation can always be activated, even in case of keypad or network control. <p>▶ Example 5: Jog forward/Jog reverse 511</p>
Jog reverse (CCW) 0x2631:011 (P400.11)	
Invert rotation 0x2631:013 (P400.13)	<p>Invert frequency setpoint.</p> <ul style="list-style-type: none"> Function can be used in combination with all start commands. Function is deactivated in case of network control. <p>▶ Example 1: Start/stop (1 signal) and reversal 505</p>

Assignment guidelines

The error message "Trigger/functions connected incorrectly" (error code [25216 | 0x6280](#)) is output if one of the following assignment guidelines is not observed:

- If the "flexible I/O configuration" is active as control source, the "Enable inverter" function or the "Run" function must be connected to a digital input in order that the motor can be stopped again any time!
- In case of keypad or network control, the two functions "Enable inverter" and "Run" can also be set to "Constant TRUE [1]" to start the motor.
- The use of the "Start forward (CW)" and "Start reverse (CCW)" functions excludes the use of the "Run forward (CW)" and "Run reverse (CCW)" and vice versa.

Flexible I/O configuration

Start / stop motor

Example 2: Change-over from terminal control to network control



Parameter	Name / value range / [default setting]	Info	
0x2631:001 (P400.01)	Function list: Enable inverter (Function list: Enable inverter) <ul style="list-style-type: none"> Setting can only be changed if the inverter is inhibited. 	Assignment of a trigger for the "Enable inverter" function. Trigger = TRUE: The inverter is enabled (unless there is another cause for inverter disable). Trigger = FALSE: The inverter is disabled. Notes: <ul style="list-style-type: none"> This function must be set to TRUE to start the motor. Either via an assigned digital input or by default setting "Constant TRUE [1]". Changing to the inhibited state causes an immediate stop of the motor, regardless of the stop method set in 0x2838:003 (P203.03). The motor becomes torqueless and coasts down as a function of the mass inertia of the machine. The cause(s) that are active for the disabled state are shown in 0x282A:001 (P126.01). 	
	0	Not connected	No trigger assigned (trigger is constantly FALSE).
	1	Constant TRUE	Trigger is constantly TRUE.
	11	Digital input 1	State of X3/DI1, taking an inversion set in 0x2632:001 (P411.01) into consideration.
	12	Digital input 2	State of X3/DI2, taking an inversion set in 0x2632:002 (P411.02) into consideration.
	13	Digital input 3	State of X3/DI3, taking an inversion set in 0x2632:003 (P411.03) into consideration.
	14	Digital input 4	State of X3/DI4, taking an inversion set in 0x2632:004 (P411.04) into consideration.
	15	Digital input 5	State of X3/DI5, taking an inversion set in 0x2632:005 (P411.05) into consideration.
	16	Digital input 6	State of X3/DI6, taking an inversion set in 0x2632:006 (P411.06) into consideration. Digital input 6 is only available in the Control Unit (CU) with application I/O.
	17	Digital input 7	State of X3/DI7, taking an inversion set in 0x2632:007 (P411.07) into consideration. Digital input 7 is only available in the Control Unit (CU) with application I/O.
	50	Running	TRUE if inverter and start are enabled and output frequency > 0.2 Hz. Otherwise FALSE.
	51	Ready for operation	TRUE if inverter is ready for operation (no error active, no STO active and DC-bus voltage ok). Otherwise FALSE.
	53	Stop active	TRUE if inverter is enabled and motor is not started and output frequency = 0.
	54	Quick stop active	TRUE if quick stop is active. Otherwise FALSE.
	58	Device warning active	TRUE if warning is active. Otherwise FALSE. <ul style="list-style-type: none"> A warning has no impact on the operating status of the inverter. A warning is reset automatically if the cause has been eliminated.
59	Device fault active	TRUE if a fault is active. Otherwise FALSE. <ul style="list-style-type: none"> In the event of a fault, the motor is brought to a standstill with the quick stop ramp. The inverter is then disabled. Exception: In case of a serious fault, the inverter is disabled immediately. The motor becomes torqueless (coasts). The error state will be left automatically if the error condition is not active anymore. The restart behaviour after trouble can be configured. ▶ Automatic restart 441 	
60	Heatsink temperature warning active	TRUE if current heatsink temperature > warning threshold for temperature monitoring. Otherwise FALSE. <ul style="list-style-type: none"> Display of the current heatsink temperature in 0x2D84:001 (P117.01). Setting of the warning threshold in 0x2D84:002. 	
69	Rotational direction reversed	TRUE if output frequency is negative. Otherwise FALSE.	
70	Frequency threshold exceeded	TRUE if current output frequency > frequency threshold. Otherwise FALSE. <ul style="list-style-type: none"> Display of the current output frequency in 0x2DDD (P100.00). Setting Frequency threshold in 0x4005 (P412.00). ▶ Frequency threshold for "Frequency threshold exceeded" trigger 564 	



Flexible I/O configuration

Start / stop motor

Example 2: Change-over from terminal control to network control

Parameter	Name / value range / [default setting]	Info
71	Actual speed = 0	TRUE if current output frequency = 0 Hz (± 0.01 Hz), irrespective of the operating mode. Otherwise FALSE. • Display of the current output frequency in 0x2DDD (P100.00) .
78	Current limit reached	TRUE if current motor current \geq maximum current. Otherwise FALSE. • Display of the present motor current in 0x2D88 (P104.00) . • Setting for the maximum current in 0x6073 (P324.00) .
79	Torque limit reached (from version 02.00)	TRUE if torque limit has been reached or exceeded. Otherwise FALSE. • Setting "Positive torque limit" in 0x60E0 . • Setting "Negative torque limit" in 0x60E1 .
81	Error of analog input 1 active	TRUE if the monitoring of the input signal at the analog input 1 has responded. Otherwise FALSE. This trigger is set as a function of the following settings: • Monitoring threshold 0x2636:008 (P430.08) • Monitoring condition 0x2636:009 (P430.09) The setting of the Error response in 0x2636:010 (P430.10) has no effect on this trigger. ▶ Analog input 1 📄 568
82	Error of analog input 2 active	TRUE if the monitoring of the input signal at the analog input 2 has responded. Otherwise FALSE. This trigger is set as a function of the following settings: • Monitoring threshold 0x2637:008 (P431.08) • Monitoring condition 0x2637:009 (P431.09) The setting of the Error response in 0x2637:010 (P431.10) has no effect on this trigger. ▶ Analog input 2 📄 572
83	Load loss detected	TRUE if actual motor current < threshold for load loss detection after delay time of the load loss detection has elapsed. Otherwise FALSE. • Display of the present motor current in 0x6078 (P103.00) . • Setting Threshold in 0x4006:001 (P710.01) . • Setting Deceleration in 0x4006:002 (P710.02) . ▶ Load loss detection 📄 397
102	Sequence suspended (from version 03.00)	Status signal of the "sequencer" function: TRUE if the sequence is currently suspended. ▶ Sequencer 📄 462
103	Sequence done (from version 03.00)	Status signal of the "sequencer" function: TRUE if the sequence is completed (final segment has been passed through). ▶ Sequencer 📄 462
104	Local control active	TRUE if local keypad control ("LOC") active. Otherwise FALSE.
105	Remote control active	TRUE if remote control ("REM") via terminals, network, etc. active. Otherwise FALSE.
106	Manual setpoint selection active	TRUE if manual setpoint selection ("MAN") via keypad active. Otherwise FALSE. • Selection of the trigger for the "Activate keypad setpoint" function in 0x2631:016 (P400.16) .
107	Automatic setpoint selection active	TRUE if automatic setpoint selection ("AUTO") via terminals, network, etc. active. Otherwise FALSE.

Flexible I/O configuration

Start / stop motor

Example 2: Change-over from terminal control to network control



Parameter	Name / value range / [default setting]	Info
0x2631:002 (P400.02)	Function list: Run (Function list: Run) <ul style="list-style-type: none"> Setting can only be changed if the inverter is inhibited. For further possible settings, see parameter 0x2631:001 (P400.01). 500 	Assignment of a trigger for the "Run" function. Function 1: Start / stop motor (default setting) Function 1 is active if no further start commands (start forward/start reverse) have been connected to triggers, no keypad control is active and no network control is active. Trigger = TRUE: Let motor rotate forward (CW). Trigger = FALSE: Stop motor. Notes to function 1: <ul style="list-style-type: none"> If "Enable inverter" 0x2631:001 (P400.01) is set = "Constant TRUE [1]", the only permissible trigger for this function is a digital input in order that the motor can be stopped again any time. The stop method can be selected in 0x2838:003 (P203.03). The function also serves to realise an automatic start after switch-on. <ul style="list-style-type: none"> ▶ Starting performance 126 Function 2: Start enable/stop motor Function 2 is active if further start commands have been connected to triggers, keypad control is active or network control is active. Trigger = TRUE: Start commands of the active control source are enabled. Trigger = FALSE: Stop motor. Notes to function 2: <ul style="list-style-type: none"> If no separate start enable is required for the application, the trigger "Constant TRUE [1]" must be set. The stop method can be selected in 0x2838:003 (P203.03).
	11 Digital input 1	State of X3/DI1, taking an inversion set in 0x2632:001 (P411.01) into consideration.
0x2631:003 (P400.03)	Function list: Activate quick stop (Function list: Quick stop) <ul style="list-style-type: none"> Setting can only be changed if the inverter is inhibited. For further possible settings, see parameter 0x2631:001 (P400.01). 500 	Assignment of a trigger for the "Activate quick stop" function. Trigger = TRUE: Activate quick stop. Trigger = FALSE: Deactivate quick stop. Notes: <ul style="list-style-type: none"> The "Quick stop" function brings the motor to a standstill within the deceleration time set in 0x291C (P225.00).
	0 Not connected	No trigger assigned (trigger is constantly FALSE).
0x2631:006 (P400.06)	Function list: Start forward (CW) (Function list: Start forward) <ul style="list-style-type: none"> Setting can only be changed if the inverter is inhibited. For further possible settings, see parameter 0x2631:001 (P400.01). 500 	Assignment of a trigger for the "Start forward (CW)" function. Trigger = FALSE ↗ TRUE (edge): Let motor rotate forward. Trigger = TRUE ↘ FALSE (edge): No action. Notes: <ul style="list-style-type: none"> In order to start the motor, "Enable inverter" 0x2631:001 (P400.01) and "Run" 0x2631:002 (P400.02) must be set to TRUE. After the start, the motor runs until "Run" is set to FALSE, another stop command is given or the inverter is disabled. In the case of a bipolar setpoint selection (e.g ±10 V), the function is executed irrespective of the rotating direction. The rotating direction is determined by the sign of the setpoint.
	0 Not connected	No trigger assigned (trigger is constantly FALSE).
0x2631:007 (P400.07)	Function list: Start reverse (CCW) (Function list: Start reverse) <ul style="list-style-type: none"> Setting can only be changed if the inverter is inhibited. For further possible settings, see parameter 0x2631:001 (P400.01). 500 	Assignment of a trigger for the "Start reverse (CCW)" function Trigger = FALSE ↗ TRUE (edge): Let motor rotate backward. Trigger = TRUE ↘ FALSE (edge): No action. Notes: <ul style="list-style-type: none"> In order to start the motor, "Enable inverter" 0x2631:001 (P400.01) and "Run" 0x2631:002 (P400.02) must be set to TRUE. After the start, the motor runs until "Run" is set to FALSE, another stop command is given or the inverter is disabled. In the case of a bipolar setpoint selection (e.g ±10 V), the function is executed irrespective of the rotating direction. The rotating direction is determined by the sign of the setpoint.
	0 Not connected	No trigger assigned (trigger is constantly FALSE).



Flexible I/O configuration

Start / stop motor

Example 2: Change-over from terminal control to network control

Parameter	Name / value range / [default setting]	Info
0x2631:008 (P400.08)	Function list: Run forward (CW) (Function list: Run forward) <ul style="list-style-type: none"> Setting can only be changed if the inverter is inhibited. For further possible settings, see parameter 0x2631:001 (P400.01). 500 	Assignment of a trigger for the "Run forward (CW)" function. Trigger = TRUE: Let motor rotate forward. Trigger = FALSE: Stop motor. Notes: <ul style="list-style-type: none"> In order to start the motor, "Enable inverter" 0x2631:001 (P400.01) and "Run" 0x2631:002 (P400.02) must be set to TRUE. The inverter always responds to the run command detected last (if start enable is available). The stop method can be selected in 0x2838:003 (P203.03). In the case of a bipolar setpoint selection (e.g ± 10 V), the function is executed irrespective of the rotating direction. The rotating direction is determined by the sign of the setpoint. The "Run forward (CW)" function also serves to realise an automatic start after switch-on. ▶ Starting performance 126
	0 Not connected	No trigger assigned (trigger is constantly FALSE).
0x2631:009 (P400.09)	Function list: Run reverse (CCW) (Function list: Run reverse) <ul style="list-style-type: none"> Setting can only be changed if the inverter is inhibited. For further possible settings, see parameter 0x2631:001 (P400.01). 500 	Assignment of a trigger for the "Run reverse (CCW)" function. Trigger = TRUE: Let motor rotate backward. Trigger = FALSE: Stop motor. Notes: <ul style="list-style-type: none"> In order to start the motor, "Enable inverter" 0x2631:001 (P400.01) and "Run" 0x2631:002 (P400.02) must be set to TRUE. The inverter always responds to the run command detected last (if start enable is available). The stop method can be selected in 0x2838:003 (P203.03). In the case of a bipolar setpoint selection (e.g ± 10 V), the function is executed irrespective of the rotating direction. The rotating direction is determined by the sign of the setpoint. The "Run reverse (CCW)" function also serves to realise an automatic start after switch-on. ▶ Starting performance 126
	0 Not connected	No trigger assigned (trigger is constantly FALSE).
0x2631:010 (P400.10)	Function list: Jog forward (CW) (Function list: Jog forward) <ul style="list-style-type: none"> Setting can only be changed if the inverter is inhibited. For further possible settings, see parameter 0x2631:001 (P400.01). 500 	Assignment of a trigger for the "Jog forward (CW)" function. Trigger = TRUE: Let motor rotate forward with preset 5. Trigger = FALSE: Stop motor. ⚠ CAUTION! The jog operation has a higher priority than the "Run" function, all other start commands and the keypad key  . <ul style="list-style-type: none"> If jog operation is active, the motor cannot be stopped with the previously mentioned functions! However, jog operation can be interrupted by the "Quick stop" function. Notes: <ul style="list-style-type: none"> The preset value 5 can be set in 0x2911:005 (P450.05). The stop method can be selected in 0x2838:003 (P203.03). If "Jog forward (CW)" and "Jog reverse (CCW)" are activated at the same time, the motor is stopped using the stop method and jog operation must be triggered again. Jog operation cannot be started automatically. The "Start at power-up" option in 0x2838:002 (P203.02) does not apply to jog operation.
	0 Not connected	No trigger assigned (trigger is constantly FALSE).

Flexible I/O configuration

Start / stop motor

Example 2: Change-over from terminal control to network control

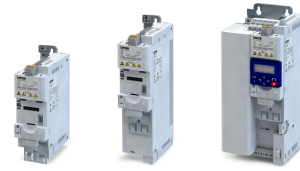

Parameter	Name / value range / [default setting]	Info
0x2631:011 (P400.11)	Function list: Jog reverse (CCW) (Function list: Jog reverse) <ul style="list-style-type: none"> Setting can only be changed if the inverter is inhibited. For further possible settings, see parameter 0x2631:001 (P400.01). □ 500 	Assignment of a trigger for the "Jog reverse (CCW)" function. Trigger = TRUE: Let motor rotate backward with preset 6. Trigger = FALSE: Stop motor. ⚠ CAUTION! The jog operation has a higher priority than the "Run" function, all other start commands and the keypad key . <ul style="list-style-type: none"> If jog operation is active, the motor cannot be stopped with the previously mentioned functions! However, jog operation can be interrupted by the "Quick stop" function. Notes: <ul style="list-style-type: none"> The preset value 6 can be set in 0x2911:006 (P450.06). The stop method can be selected in 0x2838:003 (P203.03). If "Jog forward (CW)" and "Jog reverse (CCW)" are activated at the same time, the motor is stopped using the stop method and jog operation must be triggered again. Jog operation cannot be started automatically. The "Start at power-up" option in 0x2838:002 (P203.02) does not apply to jog operation.
	0 Not connected	No trigger assigned (trigger is constantly FALSE).
0x2631:013 (P400.13)	Function list: Invert rotation (Function list: Invert rotation) <ul style="list-style-type: none"> Setting can only be changed if the inverter is inhibited. For further possible settings, see parameter 0x2631:001 (P400.01). □ 500 	Assignment of a trigger for the "Invert rotation" function. Trigger = TRUE: the setpoint specified is inverted (i. e. the sign is inverted). Trigger = FALSE: no action / deactivate function again.
	13 Digital input 3	State of X3/DI3, taking an inversion set in 0x2632:003 (P411.03) into consideration.



Flexible I/O configuration

Start / stop motor

Example 1: Start/stop (1 signal) and reversal

13.2.1 Example 1: Start/stop (1 signal) and reversal

This example shows a simple control option via two switches which should be sufficient for many applications:

- Switch S1 starts the motor in forward direction of rotation. Switch S1 in the initial position stops the motor again.
- Switch S2 switches the direction of rotation.

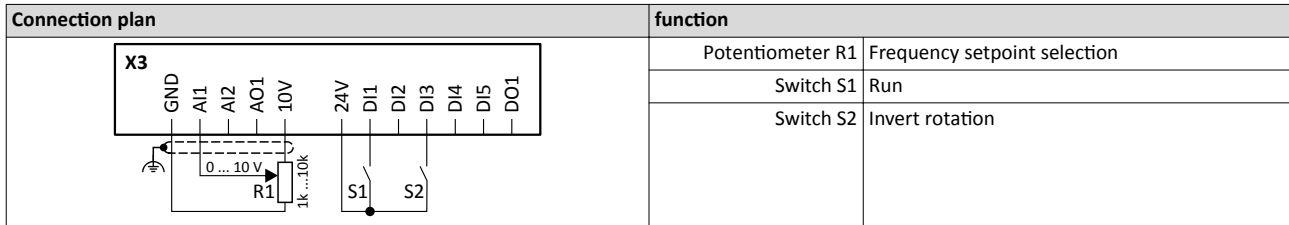

The example uses the preset I/O configuration of the inverter:

Parameter	Name	Setting for this example (corresponds to default setting)
0x2631:001 (P400.01)	Enable inverter	Constant TRUE [1]
0x2631:002 (P400.02)	Run	Digital input 1 [11]
0x2631:013 (P400.13)	Invert rotation	Digital input 3 [13]

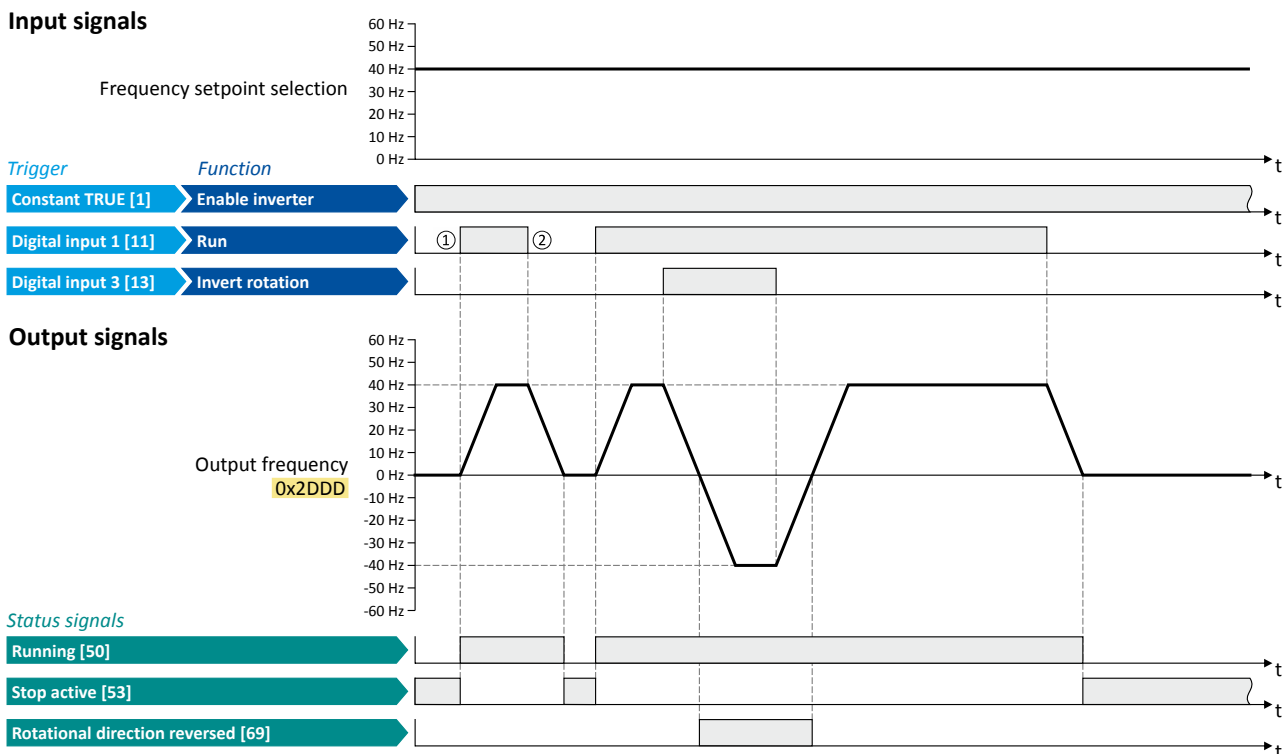

The status signals can be assigned to digital outputs. [► Configuration of digital outputs](#) 574

- ① If the inverter is enabled and no error is active, the motor can be started with the "Run" function in forward rotating direction.
- ② If "Run" is set to FALSE, the motor is stopped with the stop method set in 0x2838:003 (P203.03). In the example: Stop with standard ramp.

Flexible I/O configuration

Start / stop motor

Example 2: Start forward/start reverse/stop (edge-controlled)



13.2.2 Example 2: Start forward/start reverse/stop (edge-controlled)



The "Run" function automatically becomes a "start enable" if the functions "Start forward (CW)" / "Start reverse (CCW)" are connected to triggers.

This example shows an edge-controlled start/stop via three buttons:

- In the non-operating state of button S1 (normally-closed contact), there is already a start enable.
- Button S2 starts the motor in forward rotating direction.
- Button S3 starts the motor in backward rotating direction.
- Button S1 (normally-closed contact) stops the motor by (short-time) cancellation of the start command. The inverter then waits for the next start command via button S2/S3.

Connection plan	function	
	Potentiometer R1	Frequency setpoint selection
	Button S1	Stopping
	Button S2	Start forward (CW)
	Button S3	Start reverse (CCW)

Parameter	Name	Setting for this example
0x2631:001 (P400.01)	Enable inverter	Constant TRUE [1]
0x2631:002 (P400.02)	Run	Digital input 1 [11]
0x2631:004 (P400.04)	Reset fault	Not connected [0]
0x2631:006 (P400.06)	Start forward (CW)	Digital input 2 [12]
0x2631:007 (P400.07)	Start reverse (CCW)	Digital input 3 [13]
0x2631:013 (P400.13)	Invert rotation	Not connected [0]



Flexible I/O configuration

Start / stop motor

Example 2: Start forward/start reverse/stop (edge-controlled)

Input signals

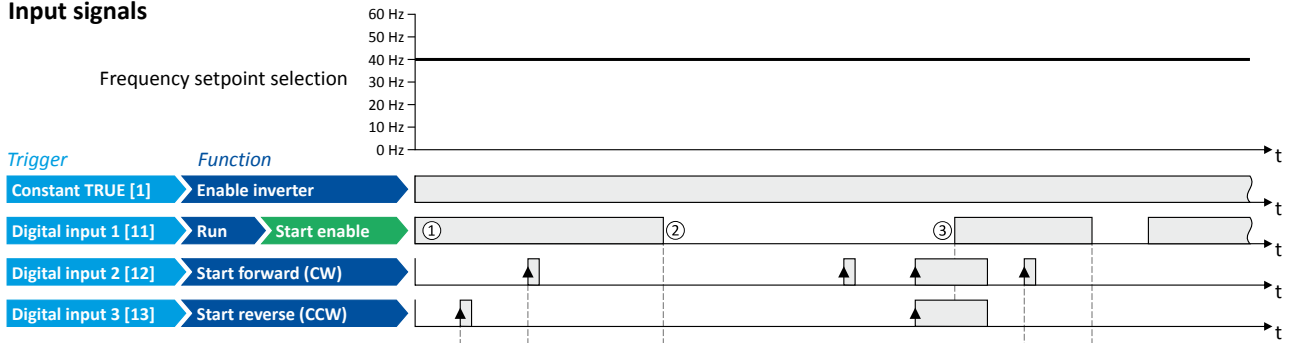

Output signals

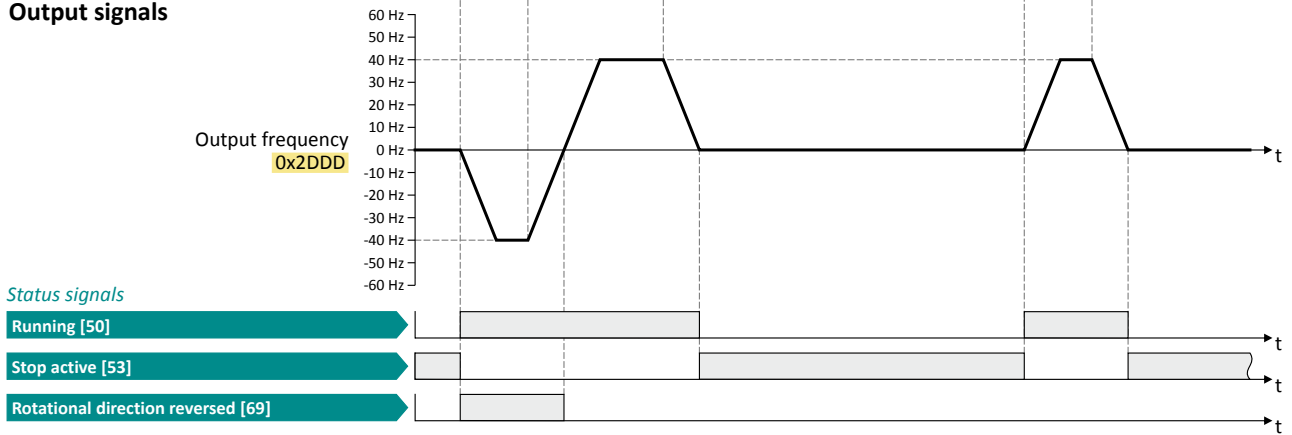

The status signals can be assigned to digital outputs. ▶ [Configuration of digital outputs](#) 574

- ① The "Run" functions serves as start enable for the functions "Start forward (CW)" and "Start reverse (CCW)". Without start enable, the motor cannot be started.
- ② If the start command is cancelled, the motor is stopped with the stop method set in [0x2838:003 \(P203.03\)](#). In the example: Stop with standard ramp.
- ③ If, at start enable, "Start forward (CW)" and "Start reverse (CCW)" are already set to TRUE, the motor remains stopped and the inverter waits for the next valid start edge.

Flexible I/O configuration

Start / stop motor

Example 3: Run forward/Run reverse/stop (status-controlled)



13.2.3 Example 3: Run forward/Run reverse/stop (status-controlled)



The "Run" function automatically becomes a "start enable" if the functions "Run forward (CW)"/"Run reverse (CCW)" are connected to triggers.

This example shows a status-controlled start/stop via three switches:

- Switch S1 enables the start. Without start enable, the motor cannot be started.
- Switch S2 starts the motor in forward direction of rotation.
- Switch S3 starts the motor in backward direction of rotation.
- The motor is stopped by cancelling the run commands (switches S2 and S3 open) or by cancelling the start enable (switch S1 open).

Connection plan		function	
		Potentiometer R1	Frequency setpoint selection
		Switch S1	Start enable
		Switch S2	Run forward (CW)
		Switch S3	Run reverse (CCW)
Parameter	Name	Setting for this example	
0x2631:001 (P400.01)	Enable inverter	Constant TRUE [1]	
0x2631:002 (P400.02)	Run	Digital input 1 [11]	
0x2631:004 (P400.04)	Reset fault	Not connected [0]	
0x2631:008 (P400.08)	Run forward (CW)	Digital input 2 [12]	
0x2631:009 (P400.09)	Run reverse (CCW)	Digital input 3 [13]	
0x2631:013 (P400.13)	Invert rotation	Not connected [0]	



Flexible I/O configuration

Start / stop motor

Example 3: Run forward/Run reverse/stop (status-controlled)

Input signals

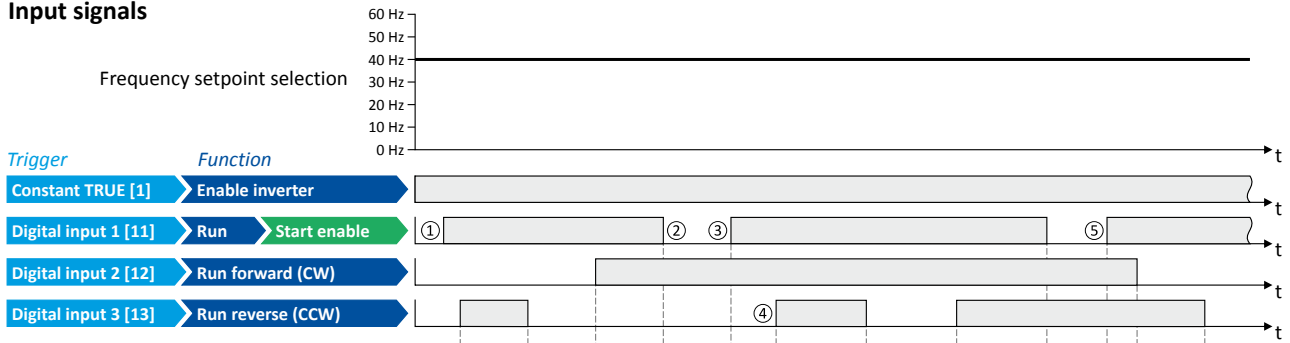

Output signals

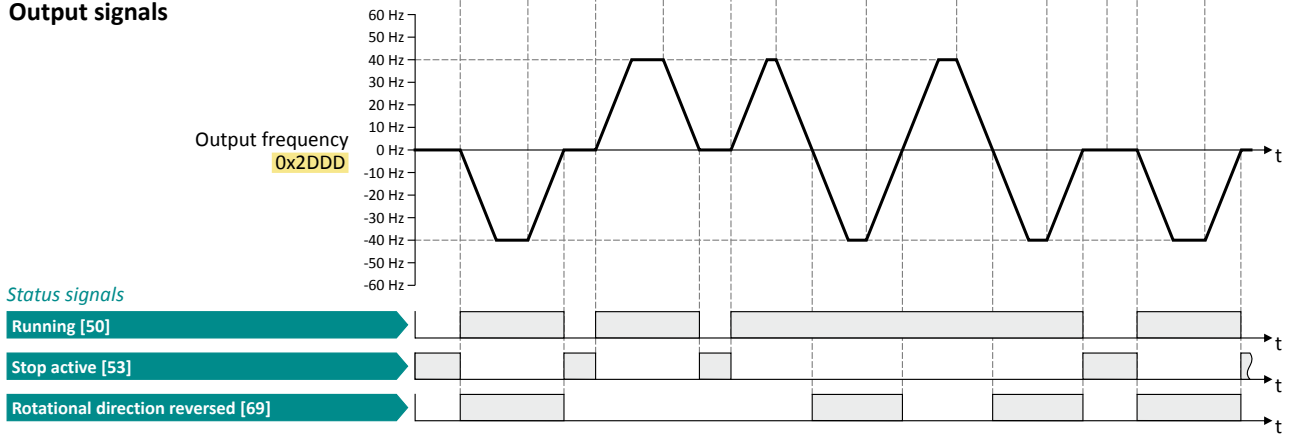

The status signals can be assigned to digital outputs. ▶ [Configuration of digital outputs](#) 574

- ① The "Run" functions serves as start enable for the functions "Run forward (CW)" and "Run reverse (CCW)". Without start enable, the motor cannot be started.
- ② If the start command is cancelled, the motor is stopped with the stop method set in `0x2838:003 (P203.03)`. In the example: Stop with standard ramp. After a renewed start enable, the inverter waits for the next run command.
- ③ If, at start enable, either "Run forward (CW)" or "Run reverse (CCW)" is set to TRUE, the motor starts into the triggered direction.
- ④ The inverter always responds to the run command detected last (if start enable is available). In the example, the "Run reverse (CCW)" command replaces the still active "Run forward (CW)" command.
- ⑤ If, at start enable, both run commands are set to TRUE, the motor remains stopped until only one valid run command is available.

Flexible I/O configuration

Start / stop motor
Example 4: Quick stop



13.2.4 Example 4: Quick stop

This example illustrates the "quick stop" function. If quick stop is activated, the motor is brought to a standstill within the deceleration time set in [0x291C \(P225.00\)](#).

- Switch S1 starts the motor in forward direction of rotation. Switch S1 in the initial position stops the motor again.
- Switch S2 activates the "quick stop" function.



Canceling the quick stop causes a restart of the motor if "Run" is still active (switch S1 closed)!

Connection plan	function	
	Potentiometer R1	Frequency setpoint selection
	Switch S1	Run
	Switch S2	Activate quick stop

Parameter	Name	Setting for this example
0x2631:001 (P400.01)	Enable inverter	Constant TRUE [1]
0x2631:002 (P400.02)	Run	Digital input 1 [11]
0x2631:003 (P400.03)	Activate quick stop	Digital input 2 [12]
0x2631:004 (P400.04)	Reset fault	Not connected [0]
0x2917 (P220.00)	Acceleration time 1	3.0 s
0x2918 (P221.00)	Deceleration time 1	3.0 s
0x291C (P225.00)	Quick stop deceleration time	1.0 s

Input signals

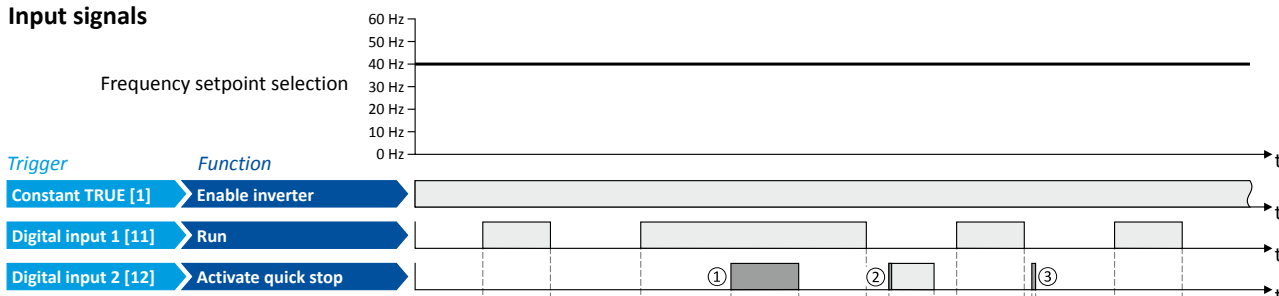

Output signals

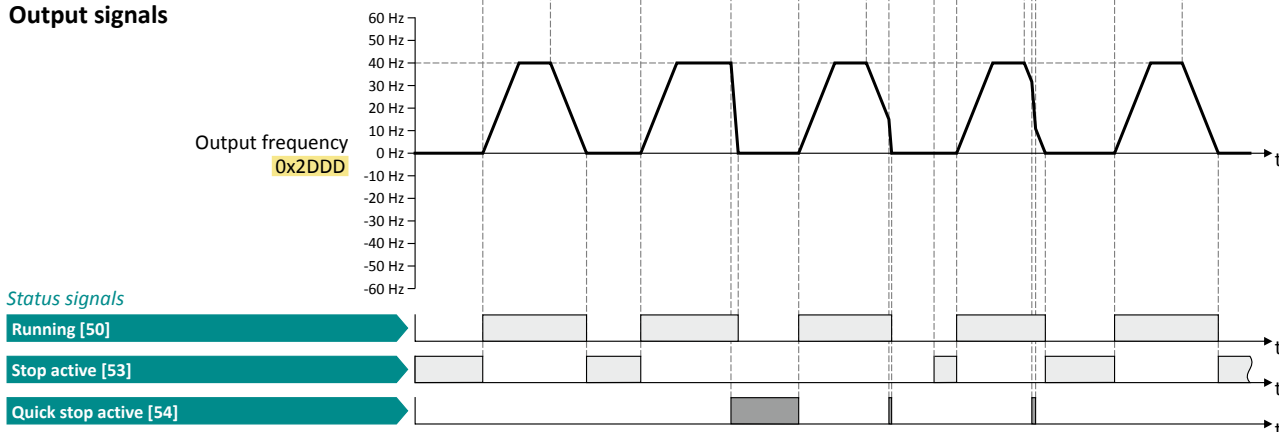

The status signals can be assigned to digital outputs. ▶ [Configuration of digital outputs](#) 574

- ① If quick stop is activated, the motor is decelerated to the frequency setpoint 0 Hz within a short period of time. The "Quick stop active [54]" status is set as long as quick stop is activated. The "Stop active [53]" status is not set.
- ② An active stop command is interrupted by a quick stop.
- ③ If quick stop is cancelled again before standstill is reached, stopping is continued with the stop method set in [0x2838:003 \(P203.03\)](#). In the example: Stop with standard ramp.



Flexible I/O configuration

Start / stop motor
Example 5: Jog forward/Jog reverse

13.2.5 Example 5: Jog forward/Jog reverse

This example illustrates the functions "Jog forward (CW)" and "Jog reverse (CCW)" for Jog operation.

- Switch S1 starts the motor in forward direction of rotation. Switch S1 in the initial position stops the motor again.
- Button S2 starts the motor in forward direction of rotation with frequency preset 5.
- Button S3 starts the motor in backward direction of rotation with frequency preset 6.
- The motor rotates in jog operation as long as the respective button is pressed. If both buttons are pressed at the same time, the motor is stopped.

i NOTICE

The jog operation has a higher priority than the "Run" function, all other start commands and the keypad key .

If jog operation is active, the motor cannot be stopped with the previously mentioned functions!

- ▶ The jog operation is stopped by cancelling the functions "Jog forward (CW)"/"Jog reverse (CCW)".
- ▶ The jog operation can be interrupted with the "Activate quick stop" [0x2631:003 \(P400.03\)](#) function.

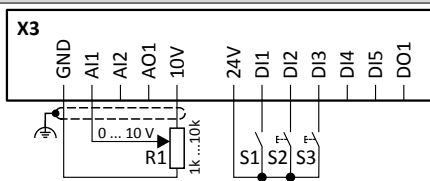
Connection plan	function
	Potentiometer R1
	Frequency setpoint selection
	Switch S1
	Run
	Button S2
	Jog forward (CW)
	Button S3
	Jog reverse (CCW)

Parameter	Name	Setting for this example
0x2631:001 (P400.01)	Enable inverter	Constant TRUE [1]
0x2631:002 (P400.02)	Run	Digital input 1 [11]
0x2631:004 (P400.04)	Reset fault	Not connected [0]
0x2631:010 (P400.10)	Jog forward (CW)	Digital input 2 [12]
0x2631:011 (P400.11)	Jog reverse (CCW)	Digital input 3 [13]
0x2631:013 (P400.13)	Invert rotation	Not connected [0]
0x2911:005 (P450.05)	Frequency setpoint presets: Preset 5	15 Hz (is used for jog forward)
0x2911:006 (P450.06)	Frequency setpoint presets: Preset 6	10 Hz (is used for jog reverse)

Flexible I/O configuration

Start / stop motor

Example 5: Jog forward/Jog reverse



Input signals

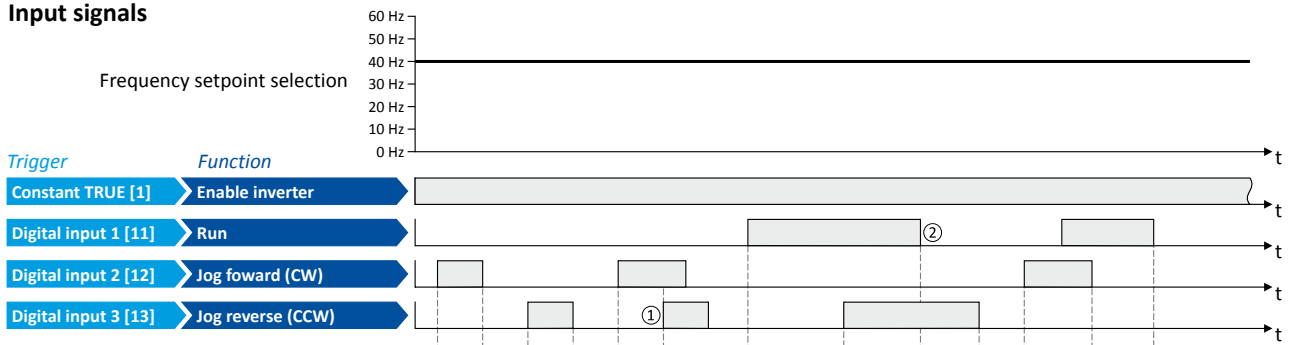

Output signals

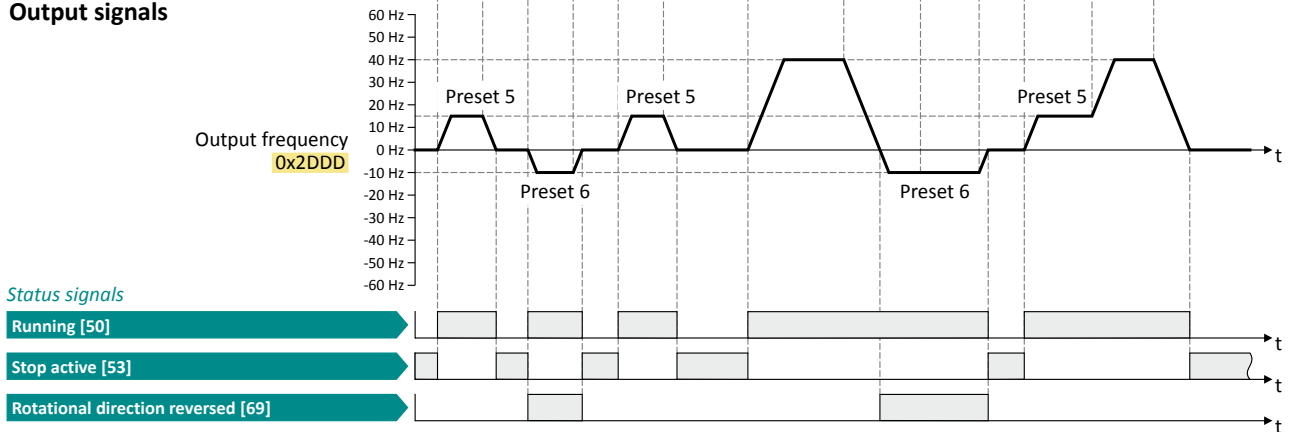

The status signals can be assigned to digital outputs. ▶ [Configuration of digital outputs](#) 574

- ① If "Jog forward (CW)" and "Jog reverse (CCW)" are activated at the same time, the motor is stopped with the stop method set in `0x2838:003` (`P203.03`) and the jog operation must be triggered again.
- ② The jog operation cannot be terminated with the "Run" function but only by cancelling the jog command.



Flexible I/O configuration

Start / stop motor
Example 6: Enable inverter

13.2.6 Example 6: Enable inverter

This example shows how to use the "Enable inverter" function for a separate enable input.

- In idle state of switch S1 (normally-closed contact), "Enable inverter" is already available.
- Switch S2 starts the motor in forward rotating direction (if switch S1 is closed). Switch S2 in initial position stops the motor again.
- Switch S1 disables the inverter. The motor becomes torqueless (coasts).

Connection plan	function
	Potentiometer R1: Frequency setpoint selection
	Switch S1: Disable inverter
	Switch S2: Run

Parameter	Name	Setting for this example
0x2631:001 (P400.01)	Enable inverter	Digital input 1 [11]
0x2631:002 (P400.02)	Run	Digital input 2 [12]
0x2631:004 (P400.04)	Reset fault	Not connected [0]

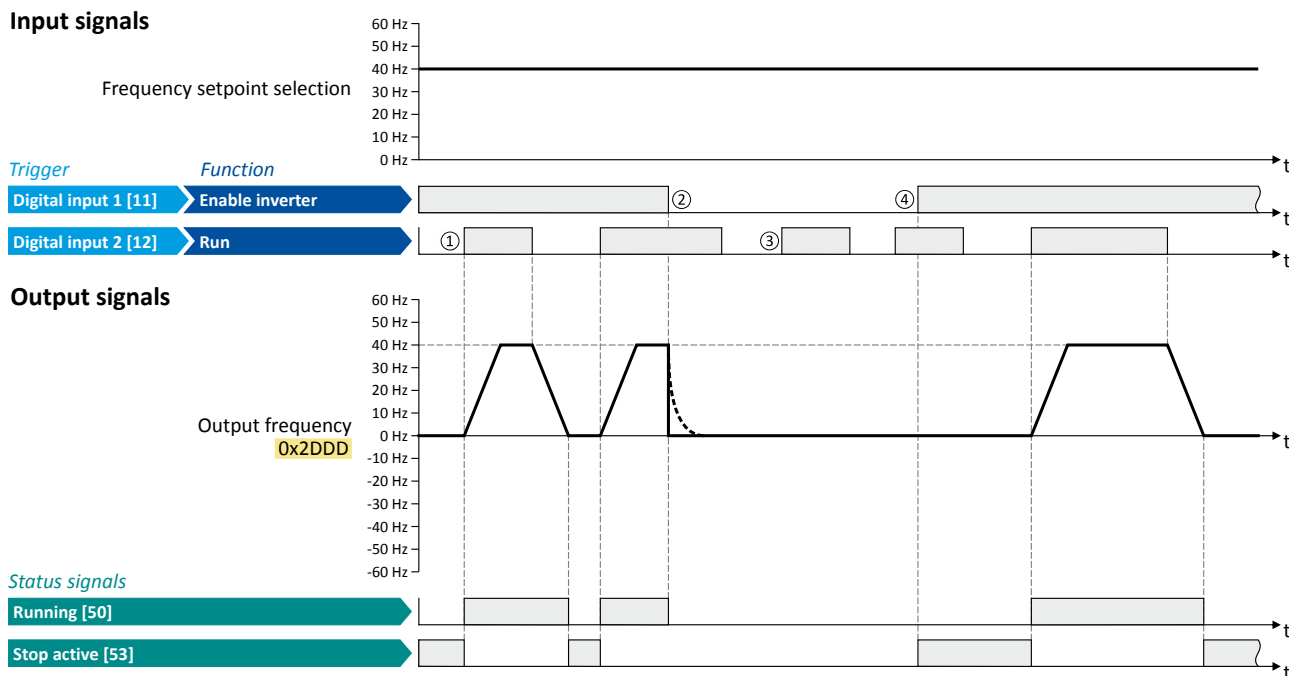

The status signals can be assigned to digital outputs. [► Configuration of digital outputs □ 574](#)

- ① If the inverter is enabled and no error is active, the motor can be started with the "Run" function in forward rotating direction.
- ② If "Enable inverter" is set to FALSE, the inverter is disabled. The motor becomes torqueless and coasts to standstill as a function of the mass inertia of the machine.
- ③ Without "Enable inverter", the motor cannot be started.
- ④ In the default setting, the motor does not start if the "Run" function is set to TRUE during "Enable inverter" . After "Enable inverter", must be retriggered to start the motor.
[► Starting performance □ 126](#)

Flexible I/O configuration

Setpoint change-over
Example 6: Enable inverter



13.3 Setpoint change-over

The inverter receives its setpoint from the selected standard setpoint source. Corresponding functions make it possible to change over to other setpoint sources during operation.

Possible setpoint sources are:

- Analog inputs
- Keypad
- Network
- Parameterisable setpoints (presets)
- Digital inputs (configured as HTL input for pulse train or HTL encoder)
- "Motor potentiometer" function
- "Sequencer" function

Details

For applications only requiring one setpoint it is sufficient to define the standard setpoint source in the following parameters:

- [0x2860:001 \(P201.01\)](#): Frequency control: Default setpoint source
- [0x2860:002 \(P201.02\)](#): PID control: Default setpoint source
- [0x2860:003 \(P201.03\)](#): Torque control: Default setpoint source

For a setpoint change-over during operation, the following functions must be configured. For details and examples see the following subchapters.

Function	Info
Activate AI1 setpoint 0x2631:014 (P400.14)	Activate analog input 1 / analog input 2 as setpoint source. ▶ Analog input setpoint source 516
Activate AI2 setpoint 0x2631:002 (P400.02)	
Activate keypad setpoint 0x2631:016 (P400.16)	Activate keypad as setpoint source. • The keypad setpoint can be changed in the operating mode via the navigation keys ↑ and ↓ keypad key. ▶ Keypad setpoint source 519
Activate network setpoint 0x2631:017 (P400.17)	Activate network as setpoint source. ▶ Network setpoint source 521
Activate preset (bit 0) 0x2631:018 (P400.18)	Activate parameterisable setpoints (presets) as setpoint source. • 15 frequency setpoints and 8 PID setpoints can be set as presets. • A preset can be selected binary-coded via the four functions "Activate preset (bit 0)" ... "Activate preset (bit 3)". ▶ Setpoint source of preset setpoints 522
Activate preset (bit 1) 0x2631:019 (P400.19)	
Activate preset (bit 2) 0x2631:020 (P400.20)	
Activate preset (bit 3) 0x2631:021 (P400.21)	
Activate setpoint via HTL input 0x2631:022 (P400.22)	The digital inputs DI3 and DI4 can be configured as HTL input to evaluate the signal of a cost-effective HTL encoder or a reference frequency ("pulse train"). ▶ HTL input setpoint source 534
Activate MOP setpoint 0x2631:025 (P400.25)	The "Motor potentiometer" function can be used as an alternative setpoint control that is controlled via two functions: "MOP setpoint up" and "MOP setpoint down". ▶ Motor potentiometer setpoint source (MOP) 528
Activate segment setpoint (bit 0) 0x2631:026 (P400.26)	Activate parameterisable segment setpoints as setpoint source. • The four functions "Activate segment setpoint (bit 0)" ... "Activate segment setpoint' (bit 3)" enable a setpoint change-over to a segment setpoint parameterised for the "sequencer" function during normal operation. ▶ Setpoint source segment setpoints 532
Activate segment setpoint (bit 1) 0x2631:027 (P400.27)	
Activate segment setpoint (bit 2) 0x2631:028 (P400.28)	
Activate segment setpoint' (bit 3) 0x2631:029 (P400.29)	



Flexible I/O configuration

Setpoint change-over
Example 6: Enable inverter

The following signal flow shows the internal setpoint logics:

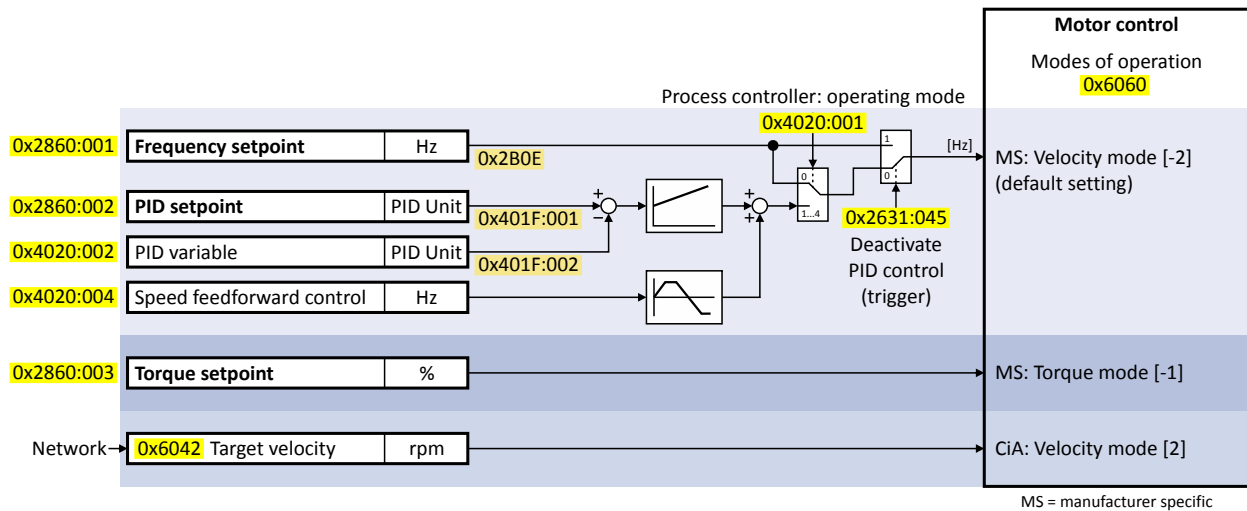

Notes:

- In case of an activated network control, the functions for setpoint change-over are not active! If in case of network control no setpoint is defined via the network control word, the standard setpoint source is active.
- The setpoint used by the motor control depends on the operating mode selected in 0x6060 (P301.00):
 - "MS: Velocity mode [-2]": The active frequency setpoint is used. In addition, the PID control can be activated in 0x4020:001 (P600.01). ▶ [Configuring the process controller](#) 356
 - "MS: Torque mode [-1]": The active torque setpoint is used. ▶ [Torque control w/ freq. limit](#) 179
 - "CiA: Velocity mode [2]": The setpoint speed defined via the "Target velocity" 0x6042 (P781.00) parameter is used. ▶ [Device profile CiA 402](#) 426
- As only one setpoint source can be active at a time, priorities are assigned to the frequency, PID and torque setpoint sources. For details see the following subchapter "[Priority of the setpoint sources](#)". 516.

Diagnostic parameters:

- 0x282B:002 (P125.02): Active setpoint source

Flexible I/O configuration

Setpoint change-over
Priority of the setpoint sources



13.3.1 Priority of the setpoint sources

Since only one setpoint source can be active at a time, the following priorities apply:

Flexible I/O configuration or keypad control active 0x2631:037 (P400.37) = FALSE	Network control active 0x2631:017 (P400.17) = FALSE 0x2631:037 (P400.37) = TRUE
<p>Prio 1: Functions for setpoint change-over</p> <p>The priority of the functions results from the assigned triggers (in the order of the selection list):</p> <ol style="list-style-type: none"> 1. Constant TRUE [1] 2. Digital input 1 [11] 3. Digital input 2 [12] 4. Digital input 3 [13] 5. ... <p>Prio 2: Set standard setpoint source</p> <ul style="list-style-type: none"> • 0x2860:001 (P201.01): Frequency control: Default setpoint source • 0x2860:002 (P201.02): PID control: Default setpoint source <p>▶ Selection of setpoint source □ 122</p>	<p>Prio 1: Setpoint source selected via network control word</p> <p>▶ General network settings □ 200</p> <p>Prio 2: Set standard setpoint source</p> <ul style="list-style-type: none"> • 0x2860:001 (P201.01): Frequency control: Default setpoint source • 0x2860:002 (P201.02): PID control: Default setpoint source <p>▶ Selection of setpoint source □ 122</p>

Example of allocating priority

Parameter	Name	Setting for this example
0x2631:014 (P400.14)	Activate AI1 setpoint	Digital input 5 [15]
0x2631:016 (P400.16)	Activate keypad setpoint	Digital input 4 [14]

Digital input 4	Digital input 5	Active setpoint source
FALSE	FALSE	Standard setpoint source set in 0x2860:001 (P201.01)
FALSE	TRUE	Analog input 1
TRUE	FALSE	keypad
TRUE	TRUE	Keypad (since "Digital input 4" trigger is higher in the selection list than "Digital input 5" trigger)

13.3.2 Analog input setpoint source

The following functions are used to select analog input 1 or analog input 2 as setpoint source.

Preconditions

A setpoint change-over to the respective analog input is only effected if no setpoint source with a higher priority has been selected. ▶ Priority of the setpoint sources [□ 516](#)

Parameter	Name / value range / [default setting]	Info
0x2631:014 (P400.14)	Function list: Activate AI1 setpoint (Function list: Setp: AI1) • For further possible settings, see parameter 0x2631:001 (P400.01). □ 500	Assignment of a trigger for the "Activate AI1 setpoint" function. Trigger = TRUE: analog input 1 is used as setpoint source (if the trigger assigned has the highest setpoint priority). Trigger = FALSE: no action / deactivate function again. ▶ Analog input 1 □ 568
	0 Not connected	No trigger assigned (trigger is constantly FALSE).



Flexible I/O configuration

Setpoint change-over
Analog input setpoint source

Parameter	Name / value range / [default setting]	Info
0x2631:015 (P400.15)	Function list: Activate AI2 setpoint (Function list: Setp: AI2) • For further possible settings, see parameter 0x2631:001 (P400.01) . 500	Assignment of a trigger for the "Activate AI2 setpoint" function. Trigger = TRUE: analog input 2 is used as setpoint source (if the trigger assigned has the highest setpoint priority). Trigger = FALSE: no action / deactivate function again. ▶ Analog input 2 572
	0 Not connected	No trigger assigned (trigger is constantly FALSE).

Example for operating mode

- The keypad is set as standard setpoint source.
- Switch S1 starts the motor in forward direction of rotation. Switch S1 in the initial position stops the motor again.
- Switch S2 switches the direction of rotation.
- Switch S3 activates analog input 1 as setpoint source.
- Switch S4 activates analog input 2 as setpoint source.



If S3 and S4 are operated at the same time, the analog input 1 is active as setpoint source since the digital input 3 assigned to this function has a higher priority than the digital input 4.

Connection plan	function
	Potentiometer R1 Frequency setpoint selection via AI1
	Potentiometer R2 Frequency setpoint selection via AI2
	Switch S1 Run
	Switch S2 Invert rotation
	Switch S3 Activate AI1 setpoint
	Switch S4 Activate AI2 setpoint

Parameter	Name	Setting for this example
0x2631:001 (P400.01)	Enable inverter	Constant TRUE [1]
0x2631:002 (P400.02)	Run	Digital input 1 [11]
0x2631:004 (P400.04)	Reset fault	Not connected [0]
0x2631:013 (P400.13)	Invert rotation	Digital input 2 [12]
0x2631:014 (P400.14)	Activate AI1 setpoint	Digital input 3 [13]
0x2631:015 (P400.15)	Activate AI2 setpoint	Digital input 4 [14]
0x2631:018 (P400.18)	Activate preset (bit 0)	Not connected [0]
0x2824 (P200.00)	Control selection	Flexible I/O configuration [0]
0x2838:003 (P203.03)	Stop method	Standard ramp [1]
0x2860:001 (P201.01)	Frequency control: Default setpoint source	Keypad [1]

Flexible I/O configuration

Setpoint change-over
Analog input setpoint source



Input signals

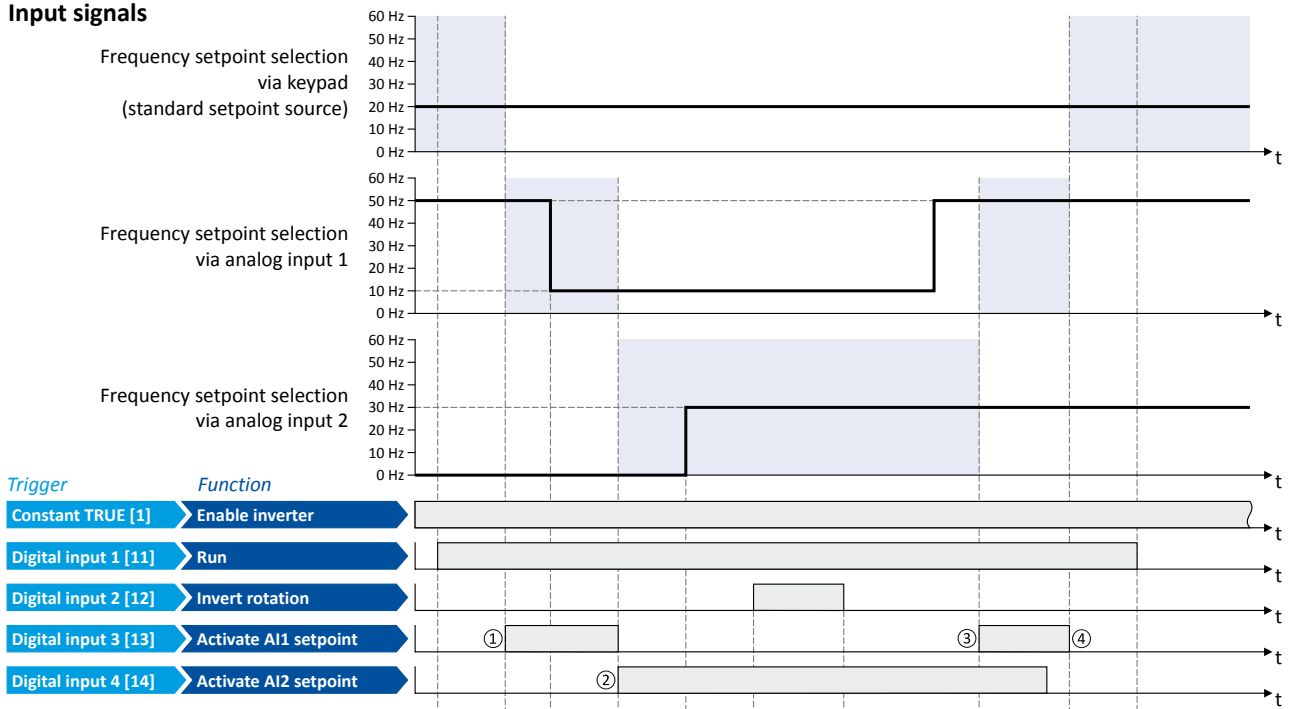

Output signals

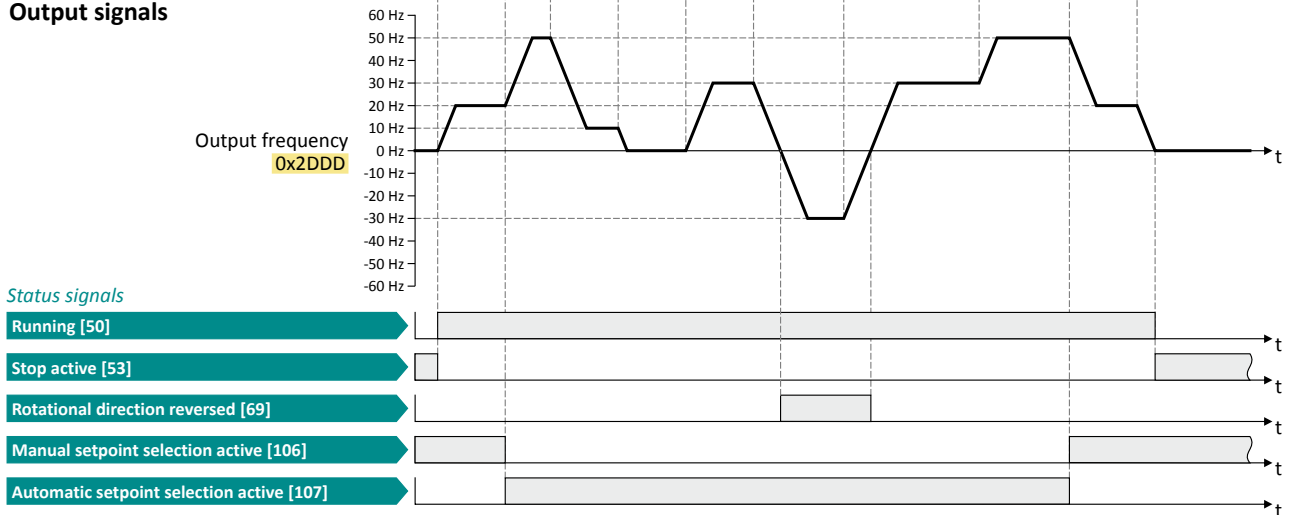

The status signals can be assigned to digital outputs. ▶ [Configuration of digital outputs](#) 574

- ① Change-over from keypad setpoint (standard setpoint source) to AI1 setpoint.
- ② Change-over from AI1 setpoint to AI2 setpoint.
- ③ Change-over from AI2 setpoint to AI1 setpoint since the digital input 3 has a higher priority than the digital input 4.
- ④ Change-over to keypad setpoint (standard setpoint source).



13.3.3 Keypad setpoint source

The following function is used to select the keypad as setpoint source.

Preconditions

A setpoint change-over to the keypad is only effected if no setpoint source with a higher priority has been selected. ▶ [Priority of the setpoint sources](#) 516

Parameter	Name / value range / [default setting]	Info
0x2631:016 (P400.16)	Function list: Activate keypad setpoint (Function list: Setp: Keypad) • For further possible settings, see parameter 0x2631:001 (P400.01) . 500	Assignment of a trigger for the "Activate keypad setpoint" function. Trigger = TRUE: the keypad is used as setpoint source (if the trigger assigned has the highest setpoint priority). Trigger = FALSE: no action / deactivate function again. Notes: • The default keypad setpoint can be changed in keypad operating mode via the arrow keys of the keypad.
	0 Not connected	No trigger assigned (trigger is constantly FALSE).

Keypad setpoint default setting

For the manual setpoint selection via keypad the following default settings are used:

- [0x2601:001 \(P202.01\)](#): Keypad setpoints: Frequency setpoint
- [0x2601:002 \(P202.02\)](#): Keypad setpoints: Process controller setpoint

The increment for keypad setpoints can be adapted in [0x2862 \(P701.00\)](#) by pressing a keypad arrow key once.

Example for operating mode

- The analog input 1 is set as standard setpoint source.
- Switch S1 starts the motor in forward direction of rotation. Switch S1 in the initial position stops the motor again.
- Switch S2 switches the direction of rotation.
- Switch S3 activates the keypad as setpoint source. The keypad setpoint can be changed in the operating mode via the navigation keys ↑ and ↓ keypad keys.

Connection plan	function
	Potentiometer R1 Frequency setpoint selection
	Switch S1 Run
	Switch S2 Invert rotation
	Switch S3 Activate keypad setpoint

Parameter	Name	Setting for this example
0x2601:001 (P202.01)	Keypad setpoints: Frequency setpoint	20.0 Hz
0x2631:001 (P400.01)	Enable inverter	Constant TRUE [1]
0x2631:002 (P400.02)	Run	Digital input 1 [11]
0x2631:004 (P400.04)	Reset fault	Not connected [0]
0x2631:013 (P400.13)	Invert rotation	Digital input 2 [12]
0x2631:016 (P400.16)	Activate keypad setpoint	Digital input 3 [13]
0x2824 (P200.00)	Control selection	Flexible I/O configuration [0]
0x2838:003 (P203.03)	Stop method	Standard ramp [1]
0x2860:001 (P201.01)	Frequency control: Default setpoint source	Analog input 1 [2]

Flexible I/O configuration

Setpoint change-over
Keypad setpoint source



Input signals

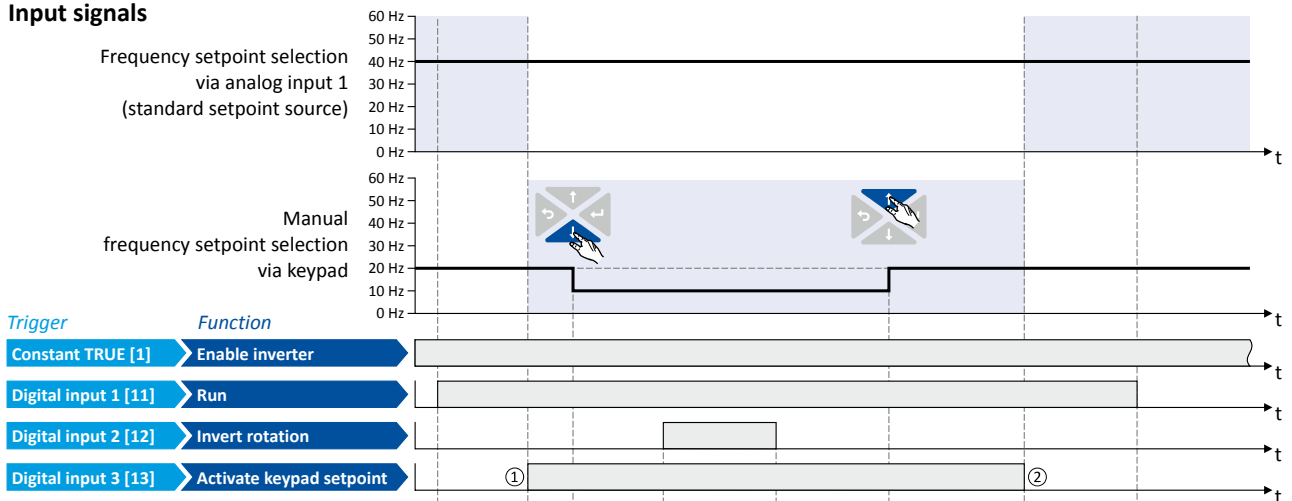

Output signals

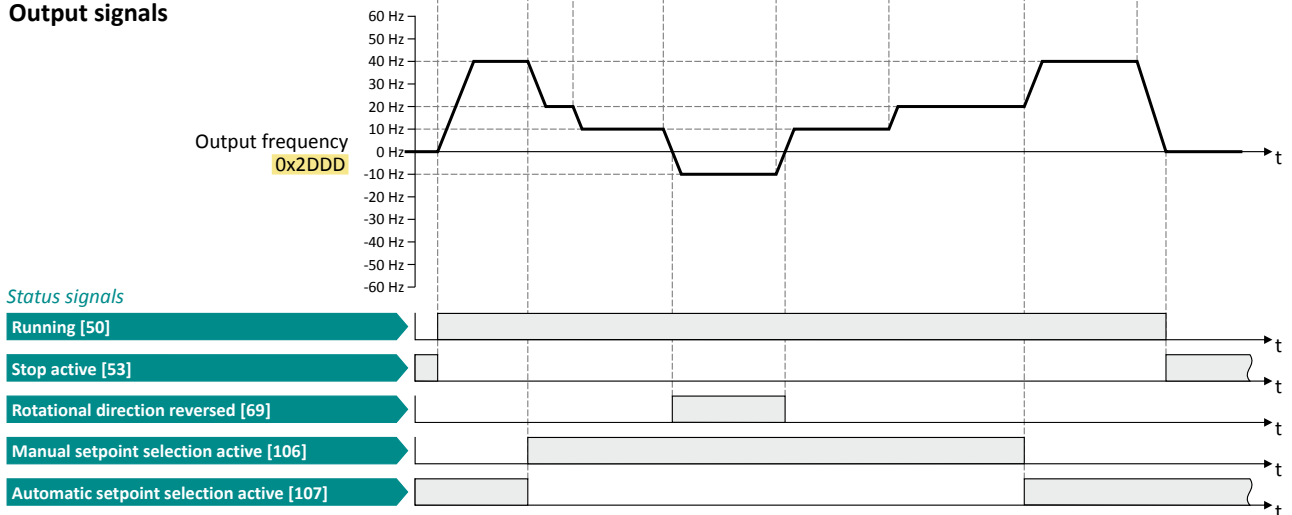

The status signals can be assigned to digital outputs. ▶ [Configuration of digital outputs](#) 574

- ① Change-over from analog input 1 (standard setpoint source) to keypad setpoint.
- ② Change-over from keypad setpoint back to analog input 1 (standard setpoint source).



13.3.4 Network setpoint source

The network can be set as standard setpoint source. Optionally, a change-over to the network setpoint is possible via the "Activate network setpoint" function (not if the network control is activated) or via network control word (if the network control is activated).



If the network control is activated, all functions for setpoint change-over are inactive!

Details

In order to generally set the network as standard setpoint source, go to [0x2860:001 \(P201.01\)](#) and select "Network [5]".

The "Activate network setpoint" [0x2631:017 \(P400.17\)](#) function enables a change-over to the network setpoint if no network control is active ([0x2631:037 \(P400.37\)](#) = "FALSE").

- A setpoint change-over is only effected if no setpoint source with a higher priority has been selected. ▶ [Priority of the setpoint sources](#) [□ 516](#)
- Application example 1: The AC drive control word shall enable a change-over from the standard setpoint source to the network setpoint. In this case, another selection than "Network [5]" must be set in [0x2860:001 \(P201.01\)](#). In addition, select "Network setpoint active [116]" in [0x2631:017 \(P400.17\)](#).
- Application example 2: Independent of the used network, a digital trigger (e. g. digital input) shall enable a change-over from the standard setpoint source to the network setpoint. In this case, another selection than "Network [5]" must be set in [0x2860:001 \(P201.01\)](#). In addition, set the desired digital trigger in [0x2631:017 \(P400.17\)](#).

If the network control is activated, a change-over to the network setpoint is possible via the used network control word:

Network control word	Change-over to network setpoint		
NetWordIN1 data word 0x4008:001 (P590.01)	Assign the function "Activate network setpoint [17]" to the bit that is to be used for activating the network setpoint.		
	• The functions that are to be triggered via bits 0 ... 15 of the NetWordIN1 data word are defined in 0x400E:001 (P505.01) ... 0x400E:016 (P505.16) .		
	Bit x	Selection:	
	0	Standard setpoint source selected in 0x2860:001 (P201.01) .	
	1	Network setpoint	
AC drive control word 0x400B:001 (P592.01)	The network setpoint is activated via bit 6 of the AC Drive control word:		
	Bit 6	Selection:	
	0	Standard setpoint source selected in 0x2860:001 (P201.01) .	
	1	Network setpoint	
LECOM control word 0x400B:002 (P592.02)	The setpoint is selected via bit 0 and bit 1 of the LECOM control word:		
	Bit 1	Bit 0	Selection:
	0	0	Standard setpoint source selected in 0x2860:001 (P201.01) .
	0	1	Frequency setpoint preset 1 0x2911:001 (P450.01)
	1	0	Frequency setpoint preset 2 0x2911:002 (P450.02)
	1	1	Frequency setpoint preset 3 0x2911:003 (P450.03)
CiA 402 Controlword 0x6040	In case of control via device profile CiA 402:		
	• In the operating mode "CiA: Velocity mode [2]", the setpoint speed defined via the "Target velocity" 0x6042 (P781.00) parameter is used. ▶ Device profile CiA 402 □ 426		
	• A change-over to an alternative setpoint source via the CiA 402 Controlword is not possible.		

▶ [General network settings](#) [□ 200](#)

Flexible I/O configuration

Setpoint change-over
Setpoint source of preset setpoints



Parameter	Name / value range / [default setting]	Info
0x2631:017 (P400.17)	Function list: Activate network setpoint (Function list: Setp: Network) <ul style="list-style-type: none"> From version 02.01 For further possible settings, see parameter 0x2631:001 (P400.01). □ 500 	Assignment of a trigger for the "Activate network setpoint" function. Trigger = TRUE: the network is used as setpoint source (if the trigger assigned has the highest setpoint priority). Trigger = FALSE: no action / deactivate function again.
	0 Not connected	No trigger assigned (trigger is constantly FALSE).
	116 Network setpoint active (from version 02.00)	TRUE if a change-over to network setpoint is requested via bit 6 of the AC drive control word 0x400B:001 (P592.01) . Otherwise FALSE. Notes: <ul style="list-style-type: none"> Set this selection if the network setpoint is to be activated via bit 6 of the AC drive control word. The AC drive control word can be used with any communication protocol. ▶ AC Drive Profile □ 221

13.3.5 Setpoint source of preset setpoints

The four functions "Activate preset (bit 0)" ... "Activate preset (bit 3)" enable change-over of the setpoint to a parameterisable setpoint (preset value).

Preconditions

A setpoint change-over to the respective preset is only effected if no setpoint source with a higher priority has been selected. [▶ Priority of the setpoint sources □ 516](#)

Details

A preset is selected in a binary-coded fashion via the triggers assigned to the four functions "Activate preset (bit 0)" ... "Activate preset (bit 3)" in compliance with the following truth table:

Activate preset				Selection			
Bit 3 0x2631:021 (P400.21)	Bit 2 0x2631:020 (P400.20)	Bit 1 0x2631:019 (P400.19)	Bit 0 0x2631:018 (P400.18)	Preset	Frequency setpoint	PID setpoint	Torque setpoint
FALSE	FALSE	FALSE	FALSE	No preset selected			
FALSE	FALSE	FALSE	TRUE	Preset 1	0x2911:001 (P450.01)	0x4022:001 (P451.01)	0x2912:001 (P452.01)
FALSE	FALSE	TRUE	FALSE	Preset 2	0x2911:002 (P450.02)	0x4022:002 (P451.02)	0x2912:002 (P452.02)
FALSE	FALSE	TRUE	TRUE	Preset 3	0x2911:003 (P450.03)	0x4022:003 (P451.03)	0x2912:003 (P452.03)
FALSE	TRUE	FALSE	FALSE	Preset 4	0x2911:004 (P450.04)	0x4022:004 (P451.04)	0x2912:004 (P452.04)
FALSE	TRUE	FALSE	TRUE	Preset 5	0x2911:005 (P450.05)	0x4022:005 (P451.05)	0x2912:005 (P452.05)
FALSE	TRUE	TRUE	FALSE	Preset 6	0x2911:006 (P450.06)	0x4022:006 (P451.06)	0x2912:006 (P452.06)
FALSE	TRUE	TRUE	TRUE	Preset 7	0x2911:007 (P450.07)	0x4022:007 (P451.07)	0x2912:007 (P452.07)
TRUE	FALSE	FALSE	FALSE	Preset 8	0x2911:008 (P450.08)	0x4022:008 (P451.08)	0x2912:008 (P452.08)
TRUE	FALSE	FALSE	TRUE	Preset 9	0x2911:009 (P450.09)		
...
TRUE	TRUE	TRUE	TRUE	Preset 15	0x2911:015 (P450.15)		

Notes:

- The frequency setpoint preset 5 is also used for the "Jog forward (CW)" [0x2631:010 \(P400.10\)](#) function.
- The frequency setpoint preset 6 is also used for the "Jog reverse (CCW)" [0x2631:011 \(P400.11\)](#) function.

Parameter	Name / value range / [default setting]	Info
0x2631:018 (P400.18)	Function list: Activate preset (bit 0) (Function list: Setp: Preset b0) <ul style="list-style-type: none"> For further possible settings, see parameter 0x2631:001 (P400.01). □ 500 	Assignment of a trigger for the "Activate preset (bit 0)" function. Selection bit with the valency 20 for the bit-coded selection and activation of a parameterised setpoint (preset value). Trigger = FALSE: selection bit = "0". Trigger = TRUE: selection bit = "1".
	14 Digital input 4	State of X3/DI4, taking an inversion set in 0x2632:004 (P411.04) into consideration.



Flexible I/O configuration

Setpoint change-over
Setpoint source of preset setpoints

Parameter	Name / value range / [default setting]	Info
0x2631:019 (P400.19)	Function list: Activate preset (bit 1) (Function list: Setp: Preset b1) <ul style="list-style-type: none"> For further possible settings, see parameter 0x2631:001 (P400.01). 500 	Assignment of a trigger for the "Activate preset (bit 1)" function. Selection bit with the valency 21 for the bit-coded selection and activation of a parameterised setpoint (preset value). Trigger = FALSE: selection bit = "0". Trigger = TRUE: selection bit = "1".
	15 Digital input 5	State of X3/DI5, taking an inversion set in 0x2632:005 (P411.05) into consideration.
0x2631:020 (P400.20)	Function list: Activate preset (bit 2) (Function list: Setp: Preset b2) <ul style="list-style-type: none"> For further possible settings, see parameter 0x2631:001 (P400.01). 500 	Assignment of a trigger for the "Activate preset (bit 2)" function. Selection bit with the valency 22 for the bit-coded selection and activation of a parameterised setpoint (preset value). Trigger = FALSE: selection bit = "0". Trigger = TRUE: selection bit = "1".
	0 Not connected	No trigger assigned (trigger is constantly FALSE).
0x2631:021 (P400.21)	Function list: Activate preset (bit 3) (Function list: Setp: Preset b3) <ul style="list-style-type: none"> For further possible settings, see parameter 0x2631:001 (P400.01). 500 	Assignment of a trigger for the "Activate preset (bit 3)" function. Selection bit with the valency 2 ³ for the bit-coded selection and activation of a parameterised setpoint (preset value). Trigger = FALSE: selection bit = "0". Trigger = TRUE: selection bit = "1".
	0 Not connected	No trigger assigned (trigger is constantly FALSE).

Flexible I/O configuration

Setpoint change-over

Setpoint source of preset setpoints



Parameter	Name / value range / [default setting]	Info
0x2911:001 (P450.01)	Frequency setpoint presets: Preset 1 (Freq. presets: Freq. preset 1) 0.0 ... [20.0] ... 599.0 Hz	Parameterisable frequency setpoints (presets) for operating mode "MS: Velocity mode".
0x2911:002 (P450.02)	Frequency setpoint presets: Preset 2 (Freq. presets: Freq. preset 2) 0.0 ... [40.0] ... 599.0 Hz	
0x2911:003 (P450.03)	Frequency setpoint presets: Preset 3 (Freq. presets: Freq. preset 3) Device for 50-Hz mains: 0.0 ... [50.0] ... 599.0 Hz Device for 60-Hz mains: 0.0 ... [60.0] ... 599.0 Hz	
0x2911:004 (P450.04)	Frequency setpoint presets: Preset 4 (Freq. presets: Freq. preset 4) 0.0 ... [0.0] ... 599.0 Hz	
0x2911:005 (P450.05)	Frequency setpoint presets: Preset 5 (Freq. presets: Freq. preset 5) 0.0 ... [0.0] ... 599.0 Hz	
0x2911:006 (P450.06)	Frequency setpoint presets: Preset 6 (Freq. presets: Freq. preset 6) 0.0 ... [0.0] ... 599.0 Hz	
0x2911:007 (P450.07)	Frequency setpoint presets: Preset 7 (Freq. presets: Freq. preset 7) 0.0 ... [0.0] ... 599.0 Hz	
0x2911:008 (P450.08)	Frequency setpoint presets: Preset 8 (Freq. presets: Freq. preset 8) 0.0 ... [0.0] ... 599.0 Hz	
0x2911:009 (P450.09)	Frequency setpoint presets: Preset 9 (Freq. presets: Freq. preset 9) 0.0 ... [0.0] ... 599.0 Hz	
0x2911:010 (P450.10)	Frequency setpoint presets: Preset 10 (Freq. presets: Freq. preset 10) 0.0 ... [0.0] ... 599.0 Hz	
0x2911:011 (P450.11)	Frequency setpoint presets: Preset 11 (Freq. presets: Freq. preset 11) 0.0 ... [0.0] ... 599.0 Hz	
0x2911:012 (P450.12)	Frequency setpoint presets: Preset 12 (Freq. presets: Freq. preset 12) 0.0 ... [0.0] ... 599.0 Hz	
0x2911:013 (P450.13)	Frequency setpoint presets: Preset 13 (Freq. presets: Freq. preset 13) 0.0 ... [0.0] ... 599.0 Hz	
0x2911:014 (P450.14)	Frequency setpoint presets: Preset 14 (Freq. presets: Freq. preset 14) 0.0 ... [0.0] ... 599.0 Hz	
0x2911:015 (P450.15)	Frequency setpoint presets: Preset 15 (Freq. presets: Freq. preset 15) 0.0 ... [0.0] ... 599.0 Hz	



Flexible I/O configuration

Setpoint change-over
Setpoint source of preset setpoints

Parameter	Name / value range / [default setting]	Info
0x4022:001 (P451.01)	PID setpoint presets: Preset 1 (PID presets: PID preset 1) -300.00 ... [0.00] ... 300.00 PID unit	Parameterisable process controller setpoints (presets) for PID control.
0x4022:002 (P451.02)	PID setpoint presets: Preset 2 (PID presets: PID preset 2) -300.00 ... [0.00] ... 300.00 PID unit	
0x4022:003 (P451.03)	PID setpoint presets: Preset 3 (PID presets: PID preset 3) -300.00 ... [0.00] ... 300.00 PID unit	
0x4022:004 (P451.04)	PID setpoint presets: Preset 4 (PID presets: PID preset 4) -300.00 ... [0.00] ... 300.00 PID unit	
0x4022:005 (P451.05)	PID setpoint presets: Preset 5 (PID presets: PID preset 5) -300.00 ... [0.00] ... 300.00 PID unit	
0x4022:006 (P451.06)	PID setpoint presets: Preset 6 (PID presets: PID preset 6) -300.00 ... [0.00] ... 300.00 PID unit	
0x4022:007 (P451.07)	PID setpoint presets: Preset 7 (PID presets: PID preset 7) -300.00 ... [0.00] ... 300.00 PID unit	
0x4022:008 (P451.08)	PID setpoint presets: Preset 8 (PID presets: PID preset 8) -300.00 ... [0.00] ... 300.00 PID unit	

Flexible I/O configuration

Setpoint change-over
Setpoint source of preset setpoints



Example for operating mode

- The keypad is set as standard setpoint source.
- Switch S1 starts the motor in forward direction of rotation. Switch S1 in the initial position stops the motor again.
- The switches S2 ... S4 serve to switch over to the presets 1 ... 7 (see the following table).

Connection plan	function				
	Switch S1	Run			
	Switches S2 ... S4	Preset selection:			
		S2	S3	S4	
		Off	Off	Off	Keypad setpoint
		On	Off	Off	Preset value 1
		Off	On	Off	Preset value 2
		On	On	Off	Preset value 3
		Off	Off	On	Preset value 4
	On	Off	On	Preset 5	
	Off	On	On	Preset 6	
	On	On	On	Preset value 7	

Parameter	Name	Setting for this example
0x2631:001 (P400.01)	Enable inverter	Constant TRUE [1]
0x2631:002 (P400.02)	Run	Digital input 1 [11]
0x2631:004 (P400.04)	Reset fault	Not connected [0]
0x2631:013 (P400.13)	Invert rotation	Not connected [0]
0x2631:018 (P400.18)	Activate preset (bit 0)	Digital input 2 [12]
0x2631:019 (P400.19)	Activate preset (bit 1)	Digital input 3 [13]
0x2631:020 (P400.20)	Activate preset (bit 2)	Digital input 4 [14]
0x2824 (P200.00)	Control selection	Flexible I/O configuration [0]
0x2838:003 (P203.03)	Stop method	Standard ramp [1]
0x2860:001 (P201.01)	Frequency control: Default setpoint source	Keypad [1]
0x2911:001 (P450.01)	Frequency setpoint presets: Preset 1	10 Hz
0x2911:002 (P450.02)	Frequency setpoint presets: Preset 2	15 Hz
0x2911:003 (P450.03)	Frequency setpoint presets: Preset 3	20 Hz
0x2911:004 (P450.04)	Frequency setpoint presets: Preset 4	25 Hz
0x2911:005 (P450.05)	Frequency setpoint presets: Preset 5	30 Hz
0x2911:006 (P450.06)	Frequency setpoint presets: Preset 6	35 Hz
0x2911:007 (P450.07)	Frequency setpoint presets: Preset 7	40 Hz



If the frequency presets 8 ... 15 are required as well, the digital input 5 must be additionally assigned to the "Activate preset (bit 3)" function and the terminal DI5 must be interconnected accordingly.



Flexible I/O configuration

Setpoint change-over Setpoint source of preset setpoints

Input signals

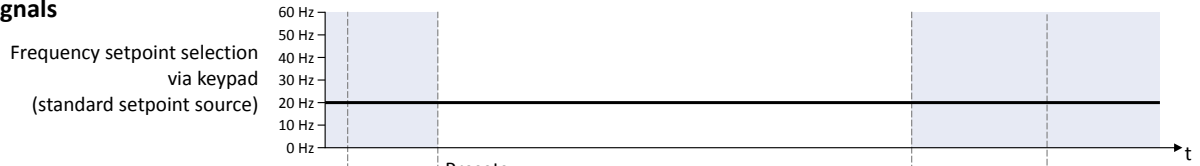

Presets						
0x2911:1	0x2911:2	0x2911:3	0x2911:4	0x2911:5	0x2911:6	0x2911:7
10 Hz	15 Hz	20 Hz	25 Hz	30 Hz	35 Hz	40 Hz

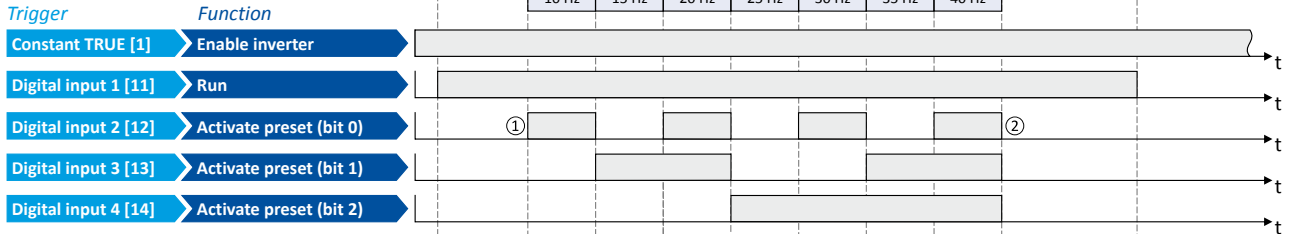

Output signals

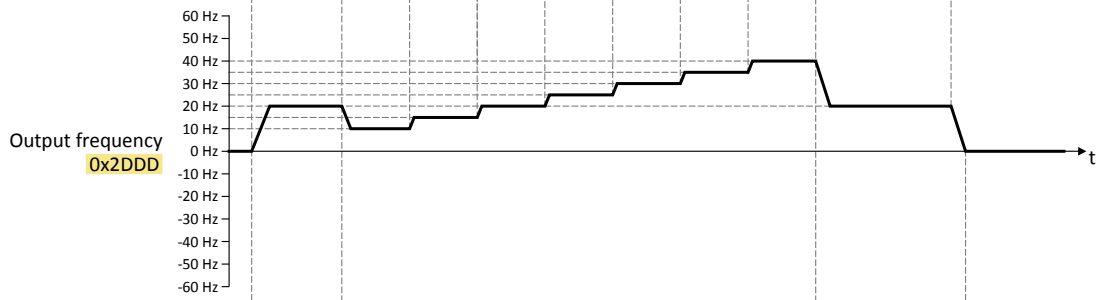

Status signals

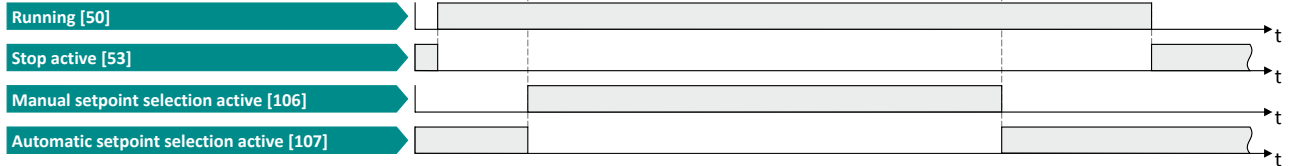

The status signals can be assigned to digital outputs. ▶ [Configuration of digital outputs](#) □ 574

- ① Change-over from keypad setpoint (standard setpoint source) to presets (first, preset 1 is selected).
- ② Change-over back to keypad setpoint since no preset is selected anymore (digital inputs 2 ... 4 = FALSE).

Flexible I/O configuration

Setpoint change-over
Motor potentiometer setpoint source (MOP)



13.3.6 Motor potentiometer setpoint source (MOP)

The "Motor potentiometer" function can be used as an alternative setpoint control that is controlled via two functions: "MOP setpoint up" and "MOP setpoint down".

- The "Activate MOP setpoint" function enables a setpoint change-over to the motor potentiometer.
- The motor potentiometer can also be defined as standard setpoint source. ▶ [Selection of setpoint source](#) [122](#)

Preconditions

A setpoint change-over to the motor potentiometer is only effected if

- no setpoint source with a higher priority has been selected. ▶ [Priority of the setpoint sources](#) [516](#)
- no jog operation is active ("Jog forward (CW)" and "Jog reverse (CCW)" functions).

Details

If the motor potentiometer is active as setpoint source, the setpoint generated by this function ("MOP value") can be changed according to the truth table via the triggers assigned to the two "MOP setpoint up" and "MOP setpoint down" functions:

MOP setpoint up 0x2631:023 (P400.23)	MOP setpoint down 0x2631:024 (P400.24)	Response of the function
FALSE	FALSE	Last MOP value is maintained.
TRUE	FALSE	MOP value is increased to a maximum of the upper limit value for the respective operating mode with acceleration time 2. (The motor follows the setpoint change with acceleration time 1.)
FALSE	TRUE	MOP value is increased to a maximum of the lower limit value for the respective operating mode with deceleration time 2. (The motor follows the setpoint change with deceleration time 1.)
TRUE	TRUE	Last MOP value is maintained.

The starting performance can be selected in [0x4003 \(P413.00\)](#). In the default setting, the last MOP value is used as initial value. The last MOP value is still available after switching off and on again the mains voltage. As an alternative, an adjustable initial value or the minimum value can be used for starting.

Parameter	Name / value range / [default setting]	Info
0x2631:023 (P400.23)	Function list: MOP setpoint up (Function list: MOP up) • For further possible settings, see parameter 0x2631:001 (P400.01) . 500	Assignment of a trigger for the "MOP setpoint up" function. Trigger = TRUE: setpoint generated by the "Motor potentiometer" function ("MOP value") is maximally increased to the upper range limit with acceleration time 2. Trigger = FALSE: last MOP value is maintained. Notes: • If the "MOP setpoint up" and "MOP setpoint down" functions are active at the same time, the last MOP value is maintained. • Acceleration time 2 can be set in 0x2919 (P222.00) .
	0 Not connected	No trigger assigned (trigger is constantly FALSE).
0x2631:024 (P400.24)	Function list: MOP setpoint down (Function list: MOP down) • For further possible settings, see parameter 0x2631:001 (P400.01) . 500	Assignment of a trigger for the "MOP setpoint down" function. Trigger = TRUE: setpoint generated by the "Motor potentiometer" function ("MOP value") is maximally decreased to the lower range limit with deceleration time 2. Trigger = FALSE: last MOP value is maintained. Notes: • If the "MOP setpoint up" and "MOP setpoint down" functions are active at the same time, the last MOP value is maintained. • Deceleration time 2 can be set in 0x291A (P223.00) .
	0 Not connected	No trigger assigned (trigger is constantly FALSE).
0x2631:025 (P400.25)	Function list: Activate MOP setpoint (Function list: Setp: MOP) • For further possible settings, see parameter 0x2631:001 (P400.01) . 500	Assignment of a trigger for the "Activate MOP setpoint" function. Trigger = TRUE: the "Motor potentiometer" function is used as setpoint source (if the trigger assigned has the highest setpoint priority). Trigger = FALSE: no action / deactivate function again.
	0 Not connected	No trigger assigned (trigger is constantly FALSE).



Flexible I/O configuration

Setpoint change-over Motor potentiometer setpoint source (MOP)

Parameter	Name / value range / [default setting]	Info
0x4003 (P413.00)	MOP starting mode (MOP startmode)	Selection of the initial value which is used after activation of the function.
	0 Last value	The last MOP value is used as initial value. It is still provided after the mains voltage has been switched off and on again. Note: The last MOP value is saved in the internal EEPROM of the inverter. If the memory module is transferred to a compatible device, the last MOP value will therefore not be accepted.
	1 Starting value	The starting value of the corresponding operating mode is used as initial value: <ul style="list-style-type: none"> 0x4004:001 (P414.01) for the operating mode "MS: Velocity mode" 0x4004:002 (P414.02) for PID control 0x4004:003 (P414.03) for the operating mode "MS: Torque mode"
	2 Minimum value	The minimum value of the corresponding operating mode is used as initial value: <ul style="list-style-type: none"> 0x2915 (P210.00) for the operating mode "MS: Velocity mode" 0x404E:001 (P605.01) for PID control
0x4004:001 (P414.01)	MOP starting values: Frequency (MOP start value: Frequency) 0.0 ... [0.0] ... 599.0 Hz	Starting value for operating mode "MS: Velocity mode". <ul style="list-style-type: none"> This value is used as initial value if "Starting value [1]" is set in 0x4003 (P413.00).
0x4004:002 (P414.02)	MOP starting values: PID value (MOP start value: PID value) -300.00 ... [0.00] ... 300.00 PID unit	Starting value for reference value of the PID control. <ul style="list-style-type: none"> This value is used as initial value if "Starting value [1]" is set in 0x4003 (P413.00).
0x4004:003 (P414.03)	MOP starting values: Torque (MOP start value: Torque) 0.0 ... [0.0] ... 1000.0 %	Starting value for operating mode "MS: Torque mode". <ul style="list-style-type: none"> This value is used as initial value if "Starting value [1]" is set in 0x4003 (P413.00).
0x4009:001	MOP values saved: Frequency <ul style="list-style-type: none"> Read only: x.x Hz 	Display of the last MOP value saved internally for the operating mode "MS: Velocity mode". <ul style="list-style-type: none"> This value is used as initial value if "Last value [0]" is set in 0x4003 (P413.00).
0x4009:002	MOP values saved: PID value <ul style="list-style-type: none"> Read only: x.xx PID unit 	Display of the last MOP value saved internally for the reference value of the PID control. <ul style="list-style-type: none"> This value is used as initial value if "Last value [0]" is set in 0x4003 (P413.00).
0x4009:003	MOP values saved: Torque <ul style="list-style-type: none"> Read only: x.x % 	Display of the last MOP value saved internally for the operating mode "MS: Torque mode". <ul style="list-style-type: none"> This value is used as initial value if "Last value [0]" is set in 0x4003 (P413.00).
0x2915 (P210.00)	Minimum frequency (Min. frequency) 0.0 ... [0.0] ... 599.0 Hz	Lower limit value for all frequency setpoints.
0x2916 (P211.00)	Maximum frequency (Max. frequency) Device for 50-Hz mains: 0.0 ... [50.0] ... 599.0 Hz Device for 60-Hz mains: 0.0 ... [60.0] ... 599.0 Hz	Upper limit value for all frequency setpoints.
0x2919 (P222.00)	Acceleration time 2 (Accelerat.time 2) 0.0 ... [5.0] ... 3600.0 s	Acceleration time 2 for the operating mode "MS: Velocity mode". <ul style="list-style-type: none"> The acceleration time set refers to the acceleration from standstill to the maximum frequency set. In the case of a lower setpoint selection, the actual acceleration time is reduced accordingly. The acceleration time 2 is active if the frequency setpoint (absolute value) \geq auto switching threshold 0x291B (P224.00) or the trigger assigned to the function "Activate ramp 2" in 0x2631:039 (P400.39) = TRUE. The acceleration time 2 is also used for changing the MOP setpoint generated by the "motor potentiometer" function. Setting is not effective in the operating mode 0x6060 (P301.00) = "CiA: Velocity mode [2]". ▶ Device profile CiA 402 □ 426

Flexible I/O configuration

Setpoint change-over

Motor potentiometer setpoint source (MOP)



Parameter	Name / value range / [default setting]	Info
0x291A (P223.00)	Deceleration time 2 (Decelerat.time 2) 0.0 ... [5.0] ... 3600.0 s	Deceleration time 2 for the operating mode "MS: Velocity mode". <ul style="list-style-type: none"> The deceleration time set refers to the deceleration from the maximum frequency set to standstill. In the case of a lower actual frequency, the actual deceleration time is reduced accordingly. The deceleration time 2 is active if the frequency setpoint (absolute value) \geq auto change-over threshold 0x291B (P224.00) or the trigger assigned to the function "Activate ramp 2" in 0x2631:039 (P400.39) = TRUE. The deceleration time 2 is also used for changing the MOP setpoint generated by the "motor potentiometer" function. Setting is not effective in the operating mode 0x6060 (P301.00) = "CiA: Velocity mode [2]". ▶ Device profile CiA 402 □ 426

Example for operating mode

- The analog input 1 is set as standard setpoint source.
- Switch S1 starts the motor in forward direction of rotation. Switch S1 in the initial position stops the motor again.
- Switch S2 activates the motor potentiometer as setpoint source. The MOP setpoint can then be increased via button S3 and reduced via button S4. If both buttons are pressed at the same time, the MOP setpoint remains unchanged.
- Switch S5 switches the direction of rotation.

Connection plan	function
	Potentiometer R1 Frequency setpoint selection
	Switch S1 Run
	Switch S2 Activate MOP setpoint
	Button S3 MOP setpoint up
	Button S4 MOP setpoint down
	Switch S5 Invert rotation

Parameter	Name	Setting for this example
0x2631:001 (P400.01)	Enable inverter	Constant TRUE [1]
0x2631:002 (P400.02)	Run	Digital input 1 [11]
0x2631:025 (P400.25)	Activate MOP setpoint	Digital input 2 [12]
0x2631:023 (P400.23)	MOP setpoint up	Digital input 3 [13]
0x2631:024 (P400.24)	MOP setpoint down	Digital input 4 [14]
0x2631:013 (P400.13)	Invert rotation	Digital input 5 [15]
0x2824 (P200.00)	Control selection	Flexible I/O configuration [0]
0x2838:003 (P203.03)	Stop method	Standard ramp [1]
0x2860:001 (P201.01)	Frequency control: Default setpoint source	Analog input 1 [2]
0x2917 (P220.00)	Acceleration time 1	1.0 s
0x2918 (P221.00)	Deceleration time 1	1.0 s
0x2919 (P222.00)	Acceleration time 2	4.0 s (for MOP setpoint change)
0x291A (P223.00)	Deceleration time 2	4.0 s (for MOP setpoint change)
0x4003 (P413.00)	MOP starting mode	Starting value [1]
0x4004:001 (P414.01)	MOP starting values: Frequency	20 Hz



Flexible I/O configuration

Setpoint change-over Motor potentiometer setpoint source (MOP)

Input signals

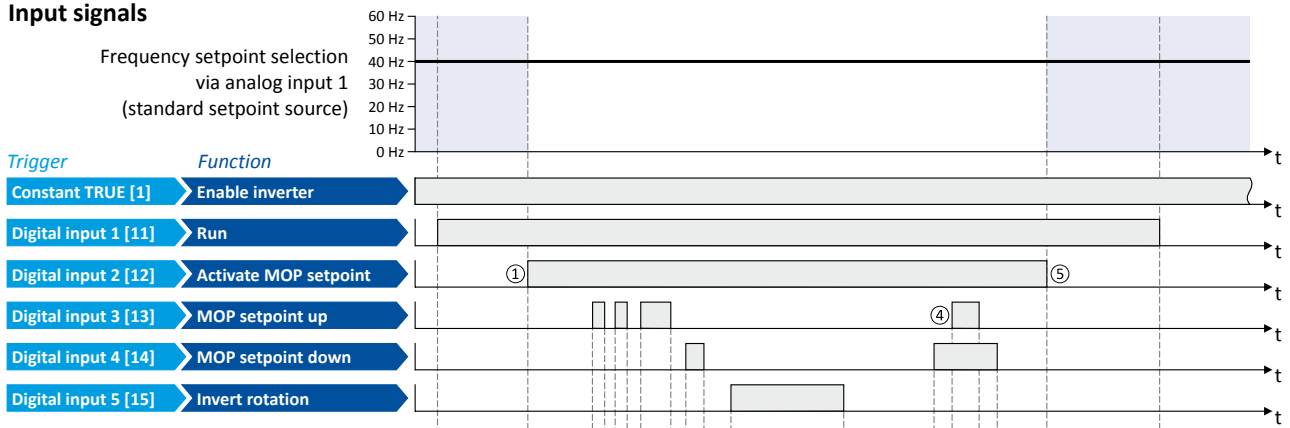

Output signals

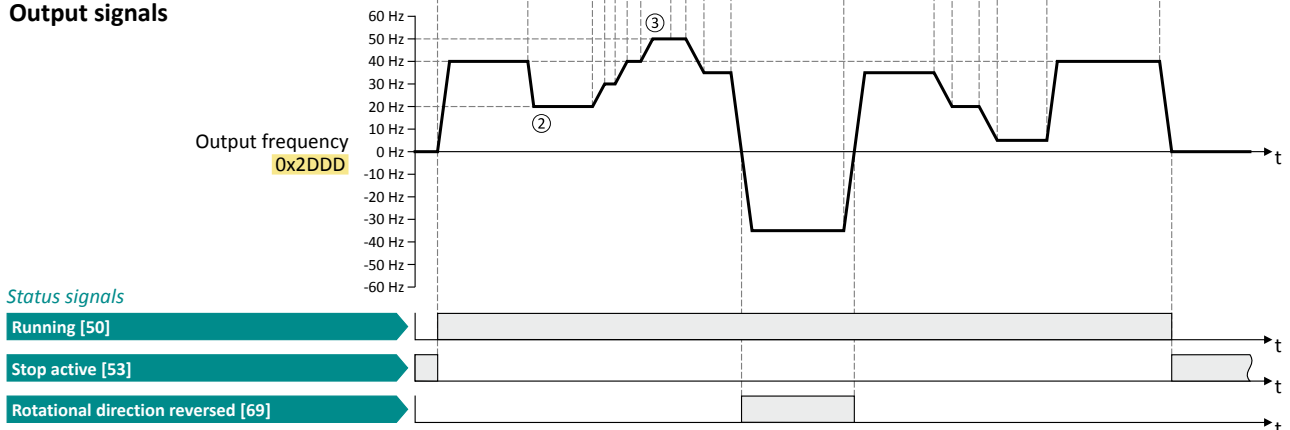

The status signals can be assigned to digital outputs. ▶ [Configuration of digital outputs](#) □ 574

- ① Change-over from analog input 1 (standard setpoint source) to MOP setpoint.
- ② The initial value for the motor potentiometer function depends on the setting in [0x4003 \(P413.00\)](#). In this example, the "starting value" set in [0x4004:001 \(P414.01\)](#) is used (here: 20 Hz).
- ③ The MOP setpoint is maximally increased to the maximum frequency set in [0x2916 \(P211.00\)](#) (here: 50 Hz).
- ④ If "MOP setpoint up" and "MOP setpoint down" are requested at the same time, the MOP setpoint remains unchanged.
- ⑤ Change-over from MOP setpoint back to analog input 1 (standard setpoint source).

Flexible I/O configuration

Setpoint change-over
Setpoint source segment setpoints



13.3.7 Setpoint source segment setpoints

The four functions "Activate segment setpoint (bit 0)" ... "Activate segment setpoint'(bit 3)" enable a setpoint change-over to a segment setpoint parameterised for the "sequencer" function during normal operation.

Preconditions

A setpoint change-over to the respective segment setpoint is only effected if no setpoint source with a higher priority has been selected. ▶ [Priority of the setpoint sources](#) 516

Details

A segment setpoint is selected in a binary-coded fashion via the triggers assigned to the four functions "Activate segment setpoint (bit 0)" ... "Activate segment setpoint'(bit 3)" in compliance with the following truth table:

Activate segment setpoint				Selection			
Bit 3 0x2631:029 (P400.29)	Bit 2 0x2631:028 (P400.28)	Bit 1 0x2631:027 (P400.27)	Bit 0 0x2631:026 (P400.26)	Segment	Frequency setpoint	PID setpoint	Torque setpoint
FALSE	FALSE	FALSE	FALSE	No segment setpoint selected			
FALSE	FALSE	FALSE	TRUE	1	0x4026:001 (P801.01)	0x4026:006 (P801.06)	0x4026:007 (P801.07)
FALSE	FALSE	TRUE	FALSE	2	0x4027:001 (P802.01)	0x4027:006 (P802.06)	0x4027:007 (P802.07)
FALSE	FALSE	TRUE	TRUE	3	0x4028:001 (P803.01)	0x4028:006 (P803.06)	0x4028:007 (P803.07)
FALSE	TRUE	FALSE	FALSE	4	0x4029:001 (P804.01)	0x4029:006 (P804.06)	0x4029:007 (P804.07)
FALSE	TRUE	FALSE	TRUE	5	0x402A:001 (P805.01)	0x402A:006 (P805.06)	0x402A:007 (P805.07)
FALSE	TRUE	TRUE	FALSE	6	0x402B:001 (P806.01)	0x402B:006 (P806.06)	0x402B:007 (P806.07)
FALSE	TRUE	TRUE	TRUE	7	0x402C:001 (P807.01)	0x402C:006 (P807.06)	0x402C:007 (P807.07)
TRUE	FALSE	FALSE	FALSE	8	0x402D:001 (P808.01)	0x402D:006 (P808.06)	0x402D:007 (P808.07)
TRUE	FALSE	FALSE	TRUE	Invalid selection			
...							
TRUE	TRUE	TRUE	TRUE				

Parameter	Name / value range / [default setting]	Info
0x2631:026 (P400.26)	Function list: Activate segment setpoint (bit 0) (Function list: Setp: Segment b0) • From version 03.00 • For further possible settings, see parameter 0x2631:001 (P400.01) . 500	Assignment of a trigger for the "Activate segment setpoint (bit 0)" function. Selection bit with the valency 20 for the bit-coded selection and activation of a parameterised segment setpoint. Trigger = FALSE: selection bit = "0". Trigger = TRUE: selection bit = "1". Notes: • During normal operation (no active sequence), this function serves to activate the setpoint of a segment (instead of an entire sequence in the sequencer operation). • This function is not intended for the use in the sequencer operation.
	0 Not connected	No trigger assigned (trigger is constantly FALSE).
0x2631:027 (P400.27)	Function list: Activate segment setpoint (bit 1) (Function list: Setp: Segment b1) • From version 03.00 • For further possible settings, see parameter 0x2631:001 (P400.01) . 500	Assignment of a trigger for the "Activate segment setpoint (bit 1)" function. Selection bit with the valency 2 ¹ for the bit-coded selection and activation of a parameterised segment setpoint. Trigger = FALSE: selection bit = "0". Trigger = TRUE: selection bit = "1". Notes: • During normal operation (no active sequence), this function serves to activate the setpoint of a segment (instead of an entire sequence in the sequencer operation). • This function is not intended for the use in the sequencer operation.
	0 Not connected	No trigger assigned (trigger is constantly FALSE).



Flexible I/O configuration

Setpoint change-over
Setpoint source segment setpoints

Parameter	Name / value range / [default setting]	Info
0x2631:028 (P400.28)	Function list: Activate segment setpoint (bit 2) (Function list: Setp: Segment b2) <ul style="list-style-type: none"> From version 03.00 For further possible settings, see parameter 0x2631:001 (P400.01). 500 	Assignment of a trigger for the "Activate segment setpoint (bit 2)" function. Selection bit with the valency 2^2 for the bit coded selection and activation of a parameterised segment setpoint. Trigger = FALSE: selection bit = "0". Trigger = TRUE: selection bit = "1". Notes: <ul style="list-style-type: none"> During normal operation (no active sequence), this function serves to activate the setpoint of a segment (instead of an entire sequence in the sequencer operation). This function is not intended for the use in the sequencer operation.
	0 Not connected	No trigger assigned (trigger is constantly FALSE).
0x2631:029 (P400.29)	Function list: Activate segment setpoint' (bit 3) (Function list: Setp: Segment b3) <ul style="list-style-type: none"> From version 03.00 For further possible settings, see parameter 0x2631:001 (P400.01). 500 	Assignment of a trigger for the "Activate segment setpoint' (bit 3)" function. Selection bit with the valency 2^3 for the bit coded selection and activation of a parameterised segment setpoint. Trigger = FALSE: selection bit = "0". Trigger = TRUE: selection bit = "1". Notes: <ul style="list-style-type: none"> During normal operation (no active sequence), this function serves to activate the setpoint of a segment (instead of an entire sequence in the sequencer operation). This function is not intended for the use in the sequencer operation.
	0 Not connected	No trigger assigned (trigger is constantly FALSE).

Flexible I/O configuration

Setpoint change-over
HTL input setpoint source



13.3.8 HTL input setpoint source

In case of the inverter i550, the digital inputs DI3 and DI4 can be configured as HTL input to evaluate the signal of a cost-effective HTL encoder or a reference frequency ("pulse train").

Many cost-effective control systems have a pulse-train output as an alternative to a real analog output.

- The HTL input can be defined as standard setpoint source. ▶ [Selection of setpoint source](#) [122](#)
- The "Activate setpoint via HTL input" [0x2631:022 \(P400.22\)](#) function enables a setpoint change-over to the HTL input.

Preconditions

- A setpoint change-over to the HTL input is only effected if no setpoint source with a higher priority has been selected. ▶ [Priority of the setpoint sources](#) [516](#)
- For using the digital inputs DI3 and DI4 as HTL input, the corresponding input function must be set in [0x2630:002 \(P410.02\)](#). ▶ [Configuration of digital inputs](#) [565](#)

Restrictions

- When the digital inputs DI3 and DI4 are configured as HTL input, these two digital inputs are no longer available for other control functions.
- The HTL input can be either used for detecting an HTL encoder signal or a pulse train. They cannot be used at the same time.
- The maximum input frequency of the digital inputs is 100 kHz. If this frequency is exceeded, an error is triggered.

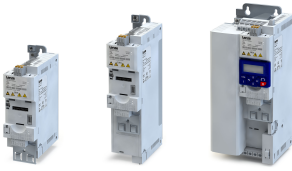

Flexible I/O configuration

Setpoint change-over
HTL input setpoint source

Details

For detecting a pulse train, the following two configurations are supported:

- a) input function **0x2630:002 (P410.02)** = "Pulse train [2]"
(DI4 = input for pulse train, DI3 = normal digital input)

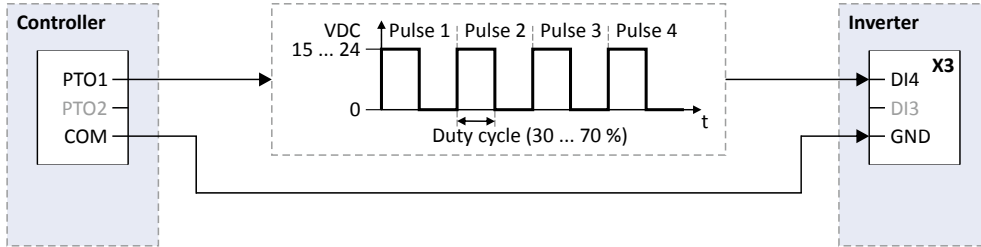

- b) input function **0x2630:002 (P410.02)** = "Pulse train/direction [3]"
(DI4 = input for pulse train, DI3 = input for specification of direction)

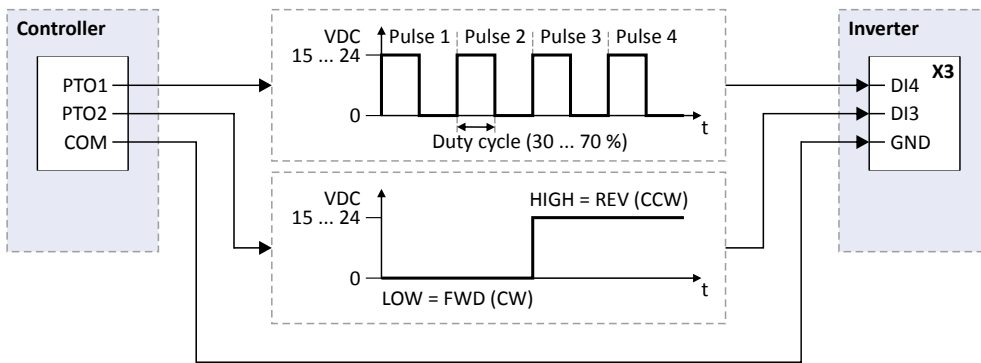

For detecting an HTL encoder AB signal, the input function "HTL encoder (AB) [1]" must be set in **0x2630:002 (P410.02)** instead. More details for configuring the HTL encoder can be found in chapter "HTL encoder". [450](#)

The following settings are possible for the HTL input:

- Definition of the input range ①
- Filter time for low-pass filters ②
- Definition of the setting range ③
- Monitoring of the input signal ④

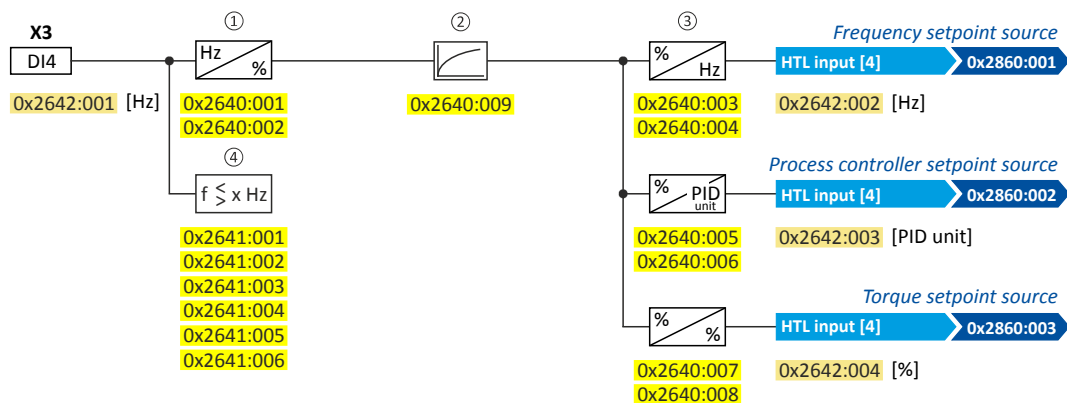

Diagnostic parameters:

- The input frequency is displayed in **0x2642:001 (P115.01)**.
- The scaled frequency value is displayed in **0x2642:002 (P115.02)**.
- The scaled process controller value is displayed in **0x2642:003 (P115.03)**.
- The scaled torque value is displayed in **0x2642:004 (P115.04)**.

Flexible I/O configuration

Setpoint change-over
HTL input setpoint source



Configuration examples

Detailed configuration examples can be found in the following subchapters:

- ▶ [Example 1: Input range 10 ... 85 kHz ≡ setting range 0 ... 50 Hz](#) [📖 538](#)
- ▶ [Example 2: Input range 10 ... 85 kHz ≡ setting range -50 ... 50 Hz](#) [📖 538](#)
- ▶ [Example 3: Pulse train as frequency setpoint source](#) [📖 539](#)

Parameter	Name / value range / [default setting]	Info
0x2631:022 (P400.22)	Function list: Activate setpoint via HTL input (Function list: Setp: HTL input) <ul style="list-style-type: none"> For further possible settings, see parameter 0x2631:001 (P400.01). 📖 500 	Assignment of a trigger for the "Activate setpoint via HTL input" function. Trigger = TRUE: HTL input is used as setpoint source (if the trigger assigned has the highest setpoint priority). Trigger = FALSE: no action / deactivate function again.
	0 Not connected	No trigger assigned (trigger is constantly FALSE).
0x2640:001 (P415.01)	HTL input settings: Minimum frequency (HTL inp. setting: Min.frequency) -100000.0 ... [0.0] ... 100000.0 Hz <ul style="list-style-type: none"> From version 04.00 	Definition of the input range of the HTL input.
0x2640:002 (P415.02)	HTL input settings: Maximum frequency (HTL inp. setting: Max. frequency) -100000.0 ... [0.0] ... 100000.0 Hz <ul style="list-style-type: none"> From version 04.00 	
0x2640:003 (P415.03)	HTL input settings: Minimum motor frequency (HTL inp. setting: Min.motor.freq) -1000.0 ... [0.0] ... 1000.0 Hz <ul style="list-style-type: none"> From version 04.00 	Definition of the setting range for operating mode "MS: Velocity mode". <ul style="list-style-type: none"> Direction of rotation according to sign. The standard setpoint source for operating mode 0x6060 (P301.00) = "MS: Velocity mode [-2]" is selected in 0x2860:001 (P201.01).
0x2640:004 (P415.04)	HTL input settings: Maximum motor frequency (HTL inp. setting: Max.motor.freq) Device for 50-Hz mains: -1000.0 ... [50.0] ... 1000.0 Hz Device for 60-Hz mains: -1000.0 ... [60.0] ... 1000.0 Hz <ul style="list-style-type: none"> From version 04.00 	
0x2640:005 (P415.05)	HTL input settings: Minimum PID setpoint (HTL inp. setting: Min.PID setpoint) -300.00 ... [0.00] ... 300.00 PID unit <ul style="list-style-type: none"> From version 04.00 	Definition of the setting range for PID control. <ul style="list-style-type: none"> The standard setpoint source for the reference value of PID control is selected in 0x2860:002 (P201.02).
0x2640:006 (P415.06)	HTL input settings: Maximum PID setpoint (HTL inp. setting: Max.PID setpoint) -300.00 ... [100.00] ... 300.00 PID unit <ul style="list-style-type: none"> From version 04.00 	
0x2640:007 (P415.07)	HTL input settings: Minimum torque setpoint (HTL inp. setting: Min.torque setp.) -400.0 ... [0.0] ... 400.0 % <ul style="list-style-type: none"> From version 04.00 	Definition of the setting range for operating mode "MS: Torque mode". <ul style="list-style-type: none"> 100 % ≡ Motor rated torque 0x6076 (P325.00) Direction of rotation according to sign. The standard setpoint source for operating mode 0x6060 (P301.00) = "MS: Torque mode [-1]" is selected in 0x2860:003 (P201.03). ▶ Torque control w/ freq. limit 📖 179
0x2640:008 (P415.08)	HTL input settings: Maximum torque setpoint (HTL inp. setting: Max.torque setp) -400.0 ... [100.0] ... 400.0 % <ul style="list-style-type: none"> From version 04.00 	
0x2640:009 (P415.09)	HTL input settings: Filter time constant (HTL inp. setting: Filter time) 0 ... [10] ... 10000 ms <ul style="list-style-type: none"> From version 04.00 	PT1 time constant for low-pass filter.



Flexible I/O configuration

Setpoint change-over
HTL input setpoint source

Parameter	Name / value range / [default setting]	Info
0x2641:001 (P416.01)	HTL input monitoring: Minimum frequency threshold (HTL inp. monit.: Min.freq.thresh.) -214748364.8 ... [0.0] ... 214748364.7 Hz • From version 04.00	Settings for monitoring the HTL input.
0x2641:002 (P416.02)	HTL input monitoring: Minimum delay threshold (HTL inp. monit.: Min.delay thres.) 0.0 ... [5.0] ... 300.0 s • From version 04.00	
0x2641:003 (P416.03)	HTL input monitoring: Maximum frequency threshold (HTL inp. monit.: Max.freq.thresh.) -214748364.8 ... [0.0] ... 214748364.7 Hz • From version 04.00	
0x2641:004 (P416.04)	HTL input monitoring: Maximum delay threshold (HTL inp. monit.: Max.delay thres.) 0.0 ... [5.0] ... 300.0 s • From version 04.00	
0x2641:005 (P416.05)	HTL input monitoring: Monitoring conditions (HTL inp. monit.: Monit. condition) • From version 04.00	Monitoring condition for HTL input. • If the selected condition is fulfilled, the response set in 0x2641:006 (P416.06) takes place.
	1 Below minimum frequency	Input frequency < minimum frequency threshold 0x2641:001 (P416.01) longer than the deceleration 0x2641:002 (P416.02) .
	2 Above maximum frequency	Input frequency > maximum frequency threshold 0x2641:003 (P416.03) longer than the deceleration 0x2641:004 (P416.04) .
	3 Below min. or above max. frequency	Input frequency < minimum frequency threshold 0x2641:001 (P416.01) longer than the deceleration 0x2641:002 (P416.02) OR input frequency > maximum frequency threshold 0x2641:003 (P416.03) longer than the deceleration 0x2641:004 (P416.04) .
0x2641:006 (P416.06)	HTL input monitoring: Error response (HTL inp. monit.: Error response) • From version 04.00 • For further possible settings, see parameter 0x2D45:001 (P310.01) . □ 196	Selection of the response to the triggering of the HTL input monitoring. • Note 1 • Note 2 Associated error code: • 28803 0x7083 - HTL input fault
	1 Warning	▶ Error types □ 113
0x2642:001 (P115.01)	HTL input diagnostics: Input frequency (HTL inp. diag.: Input frequency) • Read only: x.x Hz • From version 04.00	Display of the current input value at the HTL input.
0x2642:002 (P115.02)	HTL input diagnostics: Frequency setpoint (HTL inp. diag.: Freq. setpoint) • Read only: x.x Hz • From version 04.00	Display of the current input value at the HTL input scaled as frequency value. • The standard setpoint source for operating mode 0x6060 (P301.00) = "MS: Velocity mode [-2]" is selected in 0x2860:001 (P201.01) .
0x2642:003 (P115.03)	HTL input diagnostics: PID setpoint (HTL inp. diag.: PID setpoint) • Read only: x.xx PID unit • From version 04.00	Display of the current input value at the HTL input scaled as process controller value. • The standard setpoint source for the reference value of PID control is selected in 0x2860:002 (P201.02) .
0x2642:004 (P115.04)	HTL input diagnostics: Torque setpoint (HTL inp. diag.: Torque setpoint) • Read only: x.x % • From version 04.00	Display of the current input value at the HTL input scaled as torque value in percent. • 100 % ≡ Motor rated torque 0x6076 (P325.00) • The standard setpoint source for operating mode 0x6060 (P301.00) = "MS: Torque mode [-1]" is selected in 0x2860:003 (P201.03) .
0x2630:002 (P410.02)	Settings for digital inputs: Input function (DI settings: Input function)	Input function of the digital terminals DI3 and DI4.
	0 Digital input	DI3 = digital input DI4 = digital input
	1 HTL encoder (AB) (from version 02.00)	DI3 = HTL input for encoder track B DI4 = HTL input for encoder track A
	2 Pulse train (from version 03.00)	DI3 = digital input DI4 = HTL input for pulse train
	3 Pulse train/direction (from version 03.00)	DI3 = HTL input for direction specification; HIGH level = counter-clockwise (CCW) DI4 = HTL input for pulse train

Flexible I/O configuration

Setpoint change-over
HTL input setpoint source



13.3.8.1 Example 1: Input range 10 ... 85 kHz \equiv setting range 0 ... 50 Hz

In this configuration, a frequency setpoint between 0 and 50 Hz can be set with an HTL input frequency between 10 and 85 kHz.

Parameter	Name	Setting for this example
0x2640:001 (P415.01)	HTL input settings: Minimum frequency	10000.0 Hz
0x2640:002 (P415.02)	HTL input settings: Maximum frequency	85000.0 Hz
0x2640:003 (P415.03)	HTL input settings: Minimum motor frequency	0.0 Hz
0x2640:004 (P415.04)	HTL input settings: Maximum motor frequency	50.0 Hz
0x2640:009 (P415.09)	HTL input settings: Filter time constant	10 ms

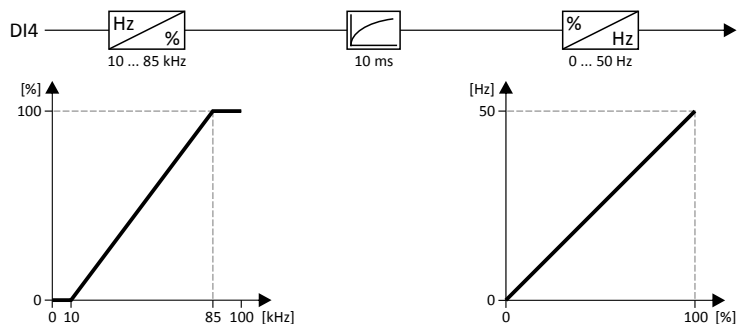

13.3.8.2 Example 2: Input range 10 ... 85 kHz \equiv setting range -50 ... 50 Hz

In this configuration, a frequency setpoint between -50 and 50 Hz can be set with an HTL input frequency between 10 and 85 kHz.

Parameter	Name	Setting for this example
0x2640:001 (P415.01)	HTL input settings: Minimum frequency	10000.0 Hz
0x2640:002 (P415.02)	HTL input settings: Maximum frequency	85000.0 Hz
0x2640:003 (P415.03)	HTL input settings: Minimum motor frequency	-50.0 Hz
0x2640:004 (P415.04)	HTL input settings: Maximum motor frequency	50.0 Hz
0x2640:009 (P415.09)	HTL input settings: Filter time constant	10 ms

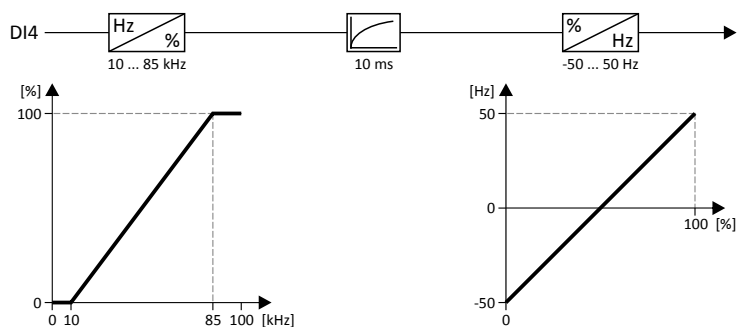



Flexible I/O configuration

Setpoint change-over
HTL input setpoint source

13.3.8.3 Example 3: Pulse train as frequency setpoint source

This example shows a configuration to control the frequency setpoint of the inverter via pulse train:

- Switch S1 starts the motor. Switch S1 in the initial position stops the motor again.
- Scaling of the pulse train signal: Input range 10 ... 85 kHz \equiv setting range 0 ... 50 Hz
- HTL input monitoring is configured in such a way that a warning is output if the pulse train signal falls below the minimum input frequency of 10 kHz for longer than 2 s.

Connection plan	Function
	Switch S1 Run
	PTO1 Pulse train output of the Controller
	PTO2 Specification of direction of rotation of the Controller

Parameter	Name	Setting for this example
0x2631:001 (P400.01)	Enable inverter	Constant TRUE [1]
0x2631:002 (P400.02)	Run	Digital input 1 [11]
0x2630:002 (P410.02)	Settings for digital inputs: Input function	Pulse train/direction [3]
0x2860:001 (P201.01)	Frequency control: Default setpoint source	HTL input [4]
HTL input settings		
0x2640:001 (P415.01)	Minimum frequency	10000.0 Hz
0x2640:002 (P415.02)	Maximum frequency	85000.0 Hz
0x2640:003 (P415.03)	Minimum motor frequency	0.0 Hz
0x2640:004 (P415.04)	Maximum motor frequency	50.0 Hz
HTL input monitoring		
0x2641:001 (P416.01)	Minimum frequency threshold	10000.0 Hz
0x2641:002 (P416.02)	Minimum delay threshold	2.0 s
0x2641:005 (P416.05)	Monitoring conditions	Below minimum frequency [1]
0x2641:006 (P416.06)	Error response	Warning [1]

Flexible I/O configuration

Setpoint change-over
HTL input setpoint source



Input signals

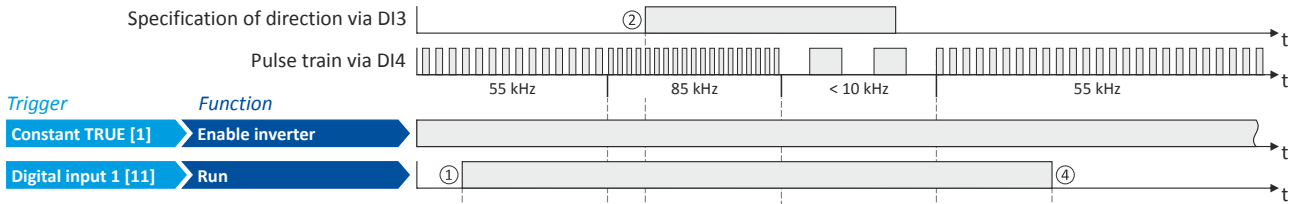

Output signals

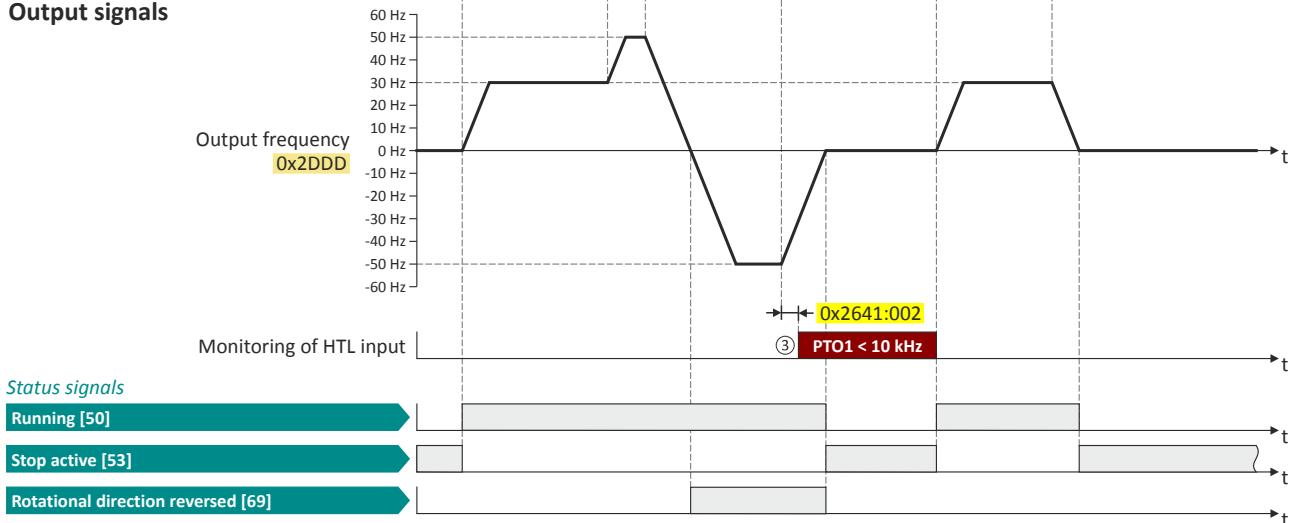

The status signals can be assigned to digital outputs. ▶ [Configuration of digital outputs](#) □ 574

- ① If the inverter is enabled and no error is active, the motor can be started with the "Run" function. The motor follows the pulse train according to the set input and setting range.
- ② The "counter-clockwise (CCW)" direction of rotation is requested externally (Controller; PTO2) via digital input DI3.
- ③ If the pulse train signal falls below the input frequency of 10 kHz, for longer than 2 s, a warning is output.
- ④ If "Run" is set to FALSE, the motor is stopped with the stop method set in 0x2838:003 (P203.03). In the example: Stop with standard ramp.



13.4 Reset error

By means of the "Reset fault" function, an active error can be reset (acknowledged).

Preconditions

The error can only be reset if the error cause has been eliminated.

Parameter	Name / value range / [default setting]	Info
0x2631:004 (P400.04)	Function list: Reset fault (Function list: Reset fault) • For further possible settings, see parameter 0x2631:001 (P400.01) . 500	Assignment of a trigger for the "Reset fault" function. Trigger = FALSE \nearrow TRUE (edge): Active error is reset (acknowledged) if the error condition is not active anymore and the error is resettable. Trigger = FALSE: no action.
	12 Digital input 2	State of X3/DI2, taking an inversion set in 0x2632:002 (P411.02) into consideration.

Further options for resetting an error

In addition to the "Reset error" function, there are the following options to reset an error:

function	Required state change to reset an error:
Enable inverter 0x2631:001 (P400.01)	TRUE \searrow FALSE (edge)
Run 0x2631:002 (P400.02)	TRUE \searrow FALSE (edge); see the following example
Keypad key 	Keystroke

Example for operating mode

- Switch S1 starts the motor in forward direction of rotation. Switch S1 in the initial position stops the motor again.
- Switch S2 resets the current error if the error condition is not active anymore and the error is resettable.
- The switches/sensors S3 and S4 serve to set the inverter from the process to the error status. [▶ Triggering a user-defined fault \[549\]\(#\)](#)

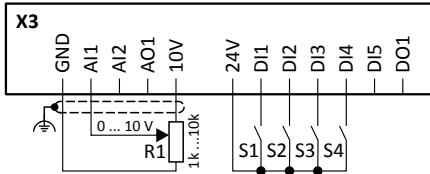
Connection plan	function	
	Potentiometer R1	Frequency setpoint selection
	Switch S1	Run
	Switch S2	Reset fault
	Switch S3	Activate fault 1
	Switch S4	Activate fault 2

Parameter	Name	Setting for this example
0x2631:001 (P400.01)	Enable inverter	Constant TRUE [1]
0x2631:002 (P400.02)	Run	Digital input 1 [11]
0x2631:004 (P400.04)	Reset fault	Digital input 2 [12]
0x2631:013 (P400.13)	Invert rotation	Not connected [0]
0x2631:018 (P400.18)	Activate preset (bit 0)	Not connected [0]
0x2631:043 (P400.43)	Activate fault 1	Digital input 3 [13]
0x2631:044 (P400.44)	Activate fault 2	Digital input 4 [14]
0x2824 (P200.00)	Control selection	Flexible I/O configuration [0]
0x2838:003 (P203.03)	Stop method	Standard ramp [1]
0x2860:001 (P201.01)	Frequency control: Default setpoint source	Analog input 1 [2]
0x2918 (P221.00)	Deceleration time 1	5.0 s
0x291C (P225.00)	Quick stop deceleration time	1.0 s

Flexible I/O configuration

Reset error



The following signal flow illustrates the reset of an error both with the "Reset error" function ② and by cancelling the start command ④:

Input signals

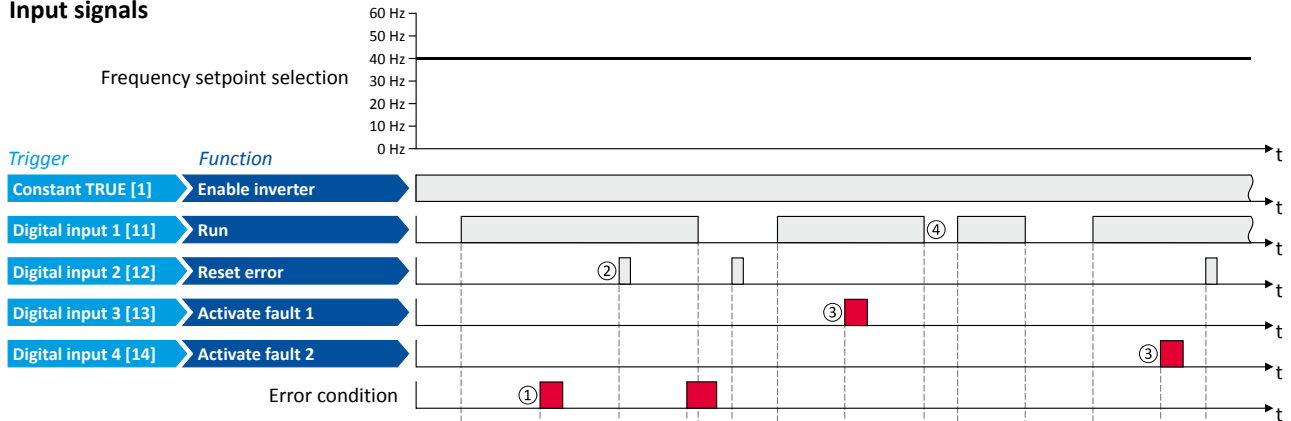

Output signals

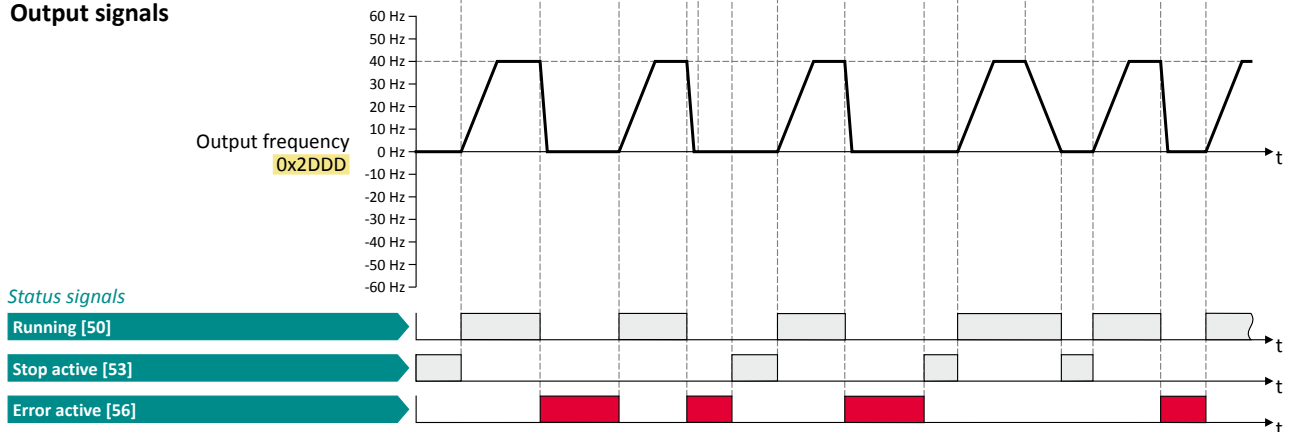

The status signals can be assigned to digital outputs. ▶ [Configuration of digital outputs](#) □ 574

- ① If an error condition is active in the inverter, the motor is brought to a standstill with the quick stop ramp. The inverter is then disabled. Exception: In case of a serious error, the inverter is disabled immediately. The motor becomes torqueless (coasts).
- ② If the error can be reset, the error state can be left again with the "Reset fault" function (if the error condition no longer exists). The motor accelerates again to the setpoint since the start command is still active.
- ③ The functions "Activate fault 1" and "Activate fault 2" serve to set the inverter from the process to the error status.
- ④ If the error can be reset, the cancelled start command results in leaving the error state (if the error condition no longer exists).

Related topics

▶ [Error handling](#) □ 113



13.5 Activating DC braking manually

By means of the "Activate DC braking" function, DC braking can be activated manually.

Preconditions

The current for DC braking must be set > 0 % so that the function can be executed.

Parameter	Name / value range / [default setting]	Info
0x2631:005 (P400.05)	Function list: Activate DC braking (Function list: DC braking) • For further possible settings, see parameter 0x2631:001 (P400.01) . 500	Assignment of a trigger for the "Activate DC braking" function. Trigger = TRUE: Activate DC braking. Trigger = FALSE: Deactivate DC braking. ⚠ CAUTION! DC braking remains active as long as the trigger is set to TRUE. ▶ DC braking 386
	0 Not connected	No trigger assigned (trigger is constantly FALSE).
0x2B84:001 (P704.01)	DC braking: Current (DC braking: Current) 0.0 ... [0.0] ... 200.0 %	Braking current for DC braking. • 100 % ≙ rated motor current 0x6075 (P323.00)

Example for operating mode

- Switch S1 starts the motor in forward direction of rotation. Switch S1 in the initial position stops the motor again.
- Switch S2 activates DC braking.

Connection plan	function
	Potentiometer R1 Frequency setpoint selection
	Switch S1 Run
	Switch S2 Activate DC braking

Parameter	Name	Setting for this example
0x2631:001 (P400.01)	Enable inverter	Constant TRUE [1]
0x2631:002 (P400.02)	Run	Digital input 1 [11]
0x2631:004 (P400.04)	Reset fault	Not connected [0]
0x2631:005 (P400.05)	Activate DC braking	Digital input 2 [12]
0x2824 (P200.00)	Control selection	Flexible I/O configuration [0]
0x2838:003 (P203.03)	Stop method	Standard ramp [1]
0x2860:001 (P201.01)	Frequency control: Default setpoint source	Analog input 1 [2]
0x2B84:001 (P704.01)	DC braking: Current	10 %

Flexible I/O configuration

Activating DC braking manually



Input signals

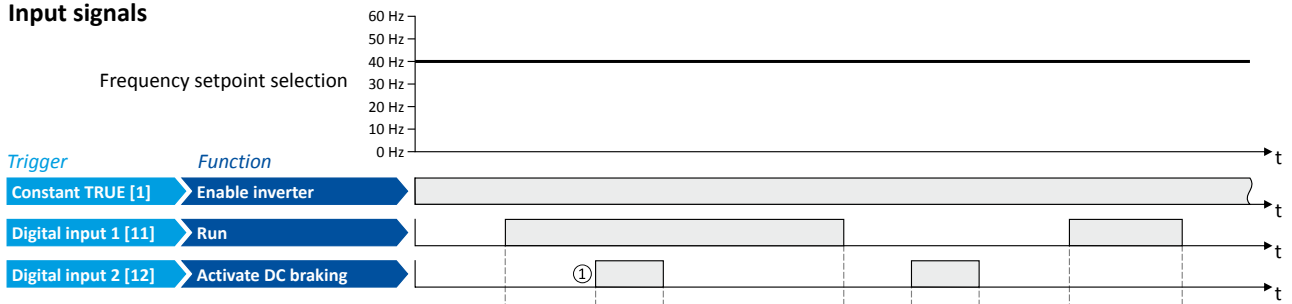

Output signals

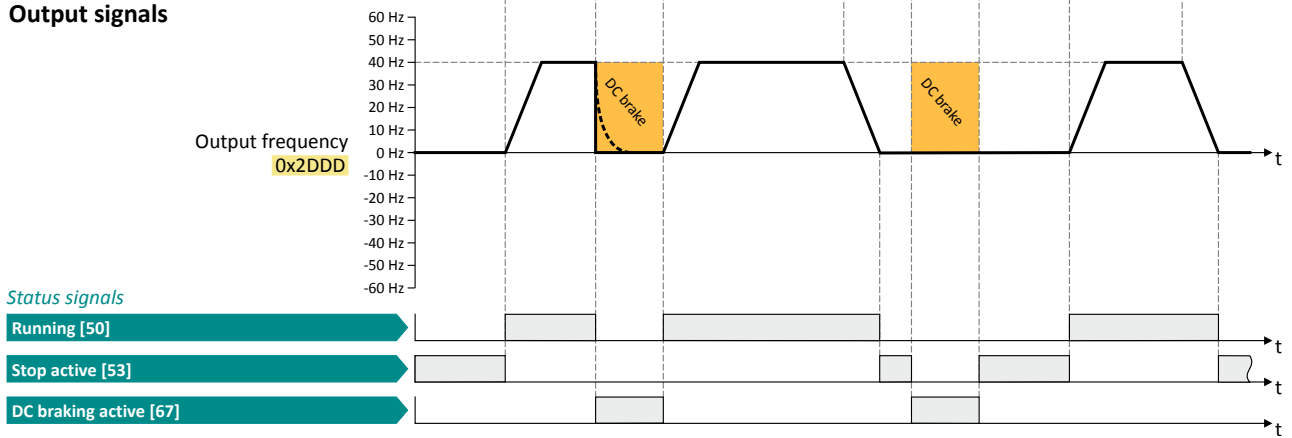

The status signals can be assigned to digital outputs. ▶ [Configuration of digital outputs](#) 574

- ① If DC braking is activated while the motor is running, the output pulses of the inverter are disabled immediately. For stopping the motor, the current set in 0x2B84:001 (P704.01) is injected. The exact drive behaviour depends on the settings for the "DC braking" function and the load properties.



13.6 Releasing holding brake manually

The "Release holding brake" function serves to release the holding brake immediately. Brake application time and brake opening time as well as the conditions for the automatic operation are not effective.

Preconditions

- Observe setting and application notes in the "Holding brake control" chapter! [429](#)
- The brake mode "Automatic [0]" or "Manual [1]" must be set in [0x2820:001 \(P712.01\)](#).
- The "Release holding brake [115]" trigger has to be assigned to a digital output or, in the simplest case, to the relay which then switches the brake supply.

Details

Detailed information about the function and configuration of the holding brake control can be found in the "Holding brake control" chapter. [429](#)

Parameter	Name / value range / [default setting]	Info
0x2631:049 (P400.49)	Function list: Release holding brake (Function list: Release brake) <ul style="list-style-type: none"> • Setting can only be changed if the inverter is inhibited. • For further possible settings, see parameter 0x2631:001 (P400.01). 500 	Assignment of a trigger for the "Release holding brake" function. Trigger = TRUE: Release holding brake (immediately). Trigger = FALSE: no action. Notes: <ul style="list-style-type: none"> • Function is only executed if the brake mode 0x2820:001 (P712.01) is set to "Automatic [0]" or "Manual [1]". ⚠ CAUTION! <ul style="list-style-type: none"> • The manually triggered "Release holding brake" command has a direct impact on the "Release holding brake [115]" trigger. Thus, the holding brake can be manually released if the power section is switched off! • The responsibility for a manual release of the holding brake has the external trigger source for the "Release holding brake" command!
	0 Not connected	No trigger assigned (trigger is constantly FALSE).

Example for operating mode

- Switch S1 starts the motor in forward direction of rotation. Switch S1 in the initial position stops the motor again.
- Switch S2 releases the holding brake. For this purpose, in this example, trigger "Release holding brake [115]" is assigned to the relay that switches the brake supply.

Connection plan	function
	Potentiometer R1 Frequency setpoint selection
	Switch S1 Run
	Switch S2 Release holding brake

Parameter	Name	Setting for this example
0x2631:001 (P400.01)	Enable inverter	Constant TRUE [1]
0x2631:002 (P400.02)	Run	Digital input 1 [11]
0x2631:004 (P400.04)	Reset fault	Not connected [0]
0x2631:049 (P400.49)	Release holding brake	Digital input 2 [12]
0x2634:001 (P420.01)	Relay	Release holding brake [115]
0x2824 (P200.00)	Control selection	Flexible I/O configuration [0]
0x2838:003 (P203.03)	Stop method	Standard ramp [1]
0x2860:001 (P201.01)	Frequency control: Default setpoint source	Analog input 1 [2]

Flexible I/O configuration

Releasing holding brake manually



Input signals

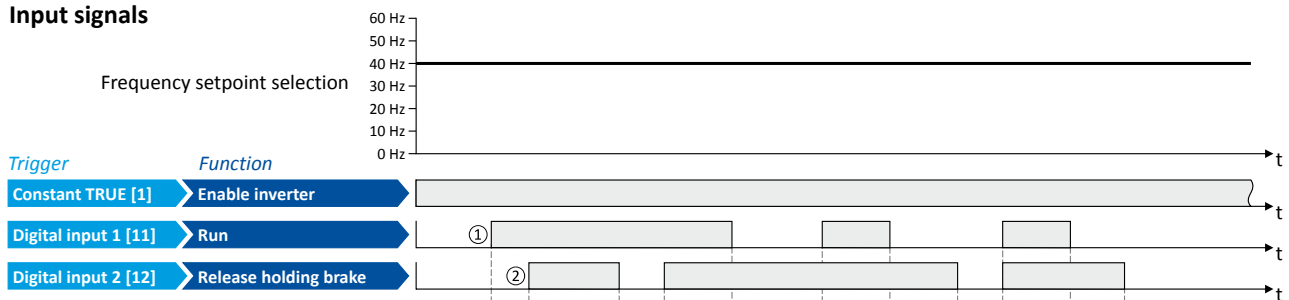

Output signals

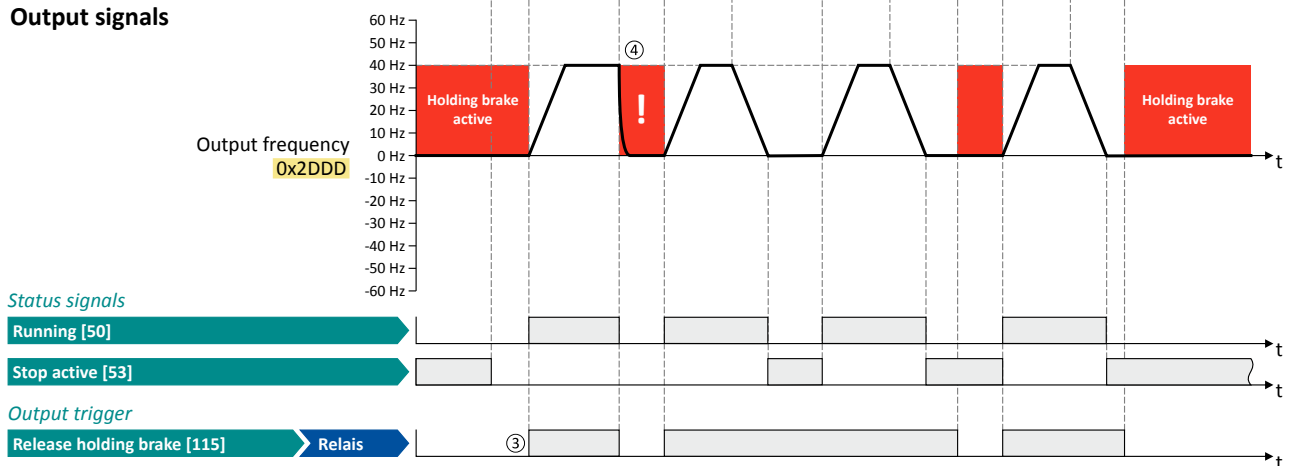

The status signals can be assigned to digital outputs. ▶ [Configuration of digital outputs](#) 574

- ① As the holding brake is active, the motor does not yet start to rotate after the start command.
- ② The holding brake is released. The motor is led to the setpoint.
- ③ In this example, the "Release holding brake [115]" trigger is assigned to the relay that switches the brake supply. In idle state, the holding brake is applied. If the relay is energised, the holding brake is released.
- ④ **Note:** Holding brakes are not intended for braking during operation. The increased wear caused by braking during operation may destroy the holding brakes prematurely!



13.7 Activating ramp 2 manually

The "Activate ramp 2" function serves to manually activate acceleration time 2 and deceleration time 2.

Parameter	Name / value range / [default setting]	Info
0x2631:039 (P400.39)	Function list: Activate ramp 2 (Function list: Activ. ramp 2) <ul style="list-style-type: none"> For further possible settings, see parameter 0x2631:001 (P400.01). □ 500 	Assignment of a trigger for the "Activate ramp 2" function. Trigger = TRUE: activate acceleration time 2 and deceleration time 2 manually. Trigger = FALSE: no action / deactivate function again. Notes: <ul style="list-style-type: none"> If the function is used and the assigned trigger = TRUE, the auto change-over threshold 0x291B (P224.00) for ramp 2 is deactivated. Acceleration time 2 can be set in 0x2919 (P222.00). Deceleration time 2 can be set in 0x291A (P223.00).
	0 Not connected	No trigger assigned (trigger is constantly FALSE).
0x2917 (P220.00)	Acceleration time 1 (Accelerat.time 1) 0.0 ... [5.0] ... 3600.0 s	Acceleration time 1 for the operating mode "MS: Velocity mode". <ul style="list-style-type: none"> The acceleration time set refers to the acceleration from standstill to the maximum frequency set. In the case of a lower setpoint selection, the actual acceleration time is reduced accordingly. Setting is not effective in the operating mode 0x6060 (P301.00) = "CiA: Velocity mode [2]". ▶ Device profile CiA 402 □ 426
0x2918 (P221.00)	Deceleration time 1 (Decelerat.time 1) 0.0 ... [5.0] ... 3600.0 s	Deceleration time 1 for the operating mode "MS: Velocity mode". <ul style="list-style-type: none"> The deceleration time set refers to the deceleration from the maximum frequency set to standstill. In the case of a lower actual frequency, the actual deceleration time is reduced accordingly. Setting is not effective in the operating mode 0x6060 (P301.00) = "CiA: Velocity mode [2]". ▶ Device profile CiA 402 □ 426
0x2919 (P222.00)	Acceleration time 2 (Accelerat.time 2) 0.0 ... [5.0] ... 3600.0 s	Acceleration time 2 for the operating mode "MS: Velocity mode". <ul style="list-style-type: none"> The acceleration time set refers to the acceleration from standstill to the maximum frequency set. In the case of a lower setpoint selection, the actual acceleration time is reduced accordingly. The acceleration time 2 is active if the frequency setpoint (absolute value) \geq auto switching threshold 0x291B (P224.00) or the trigger assigned to the function "Activate ramp 2" in 0x2631:039 (P400.39) = TRUE. The acceleration time 2 is also used for changing the MOP setpoint generated by the "motor potentiometer" function. Setting is not effective in the operating mode 0x6060 (P301.00) = "CiA: Velocity mode [2]". ▶ Device profile CiA 402 □ 426
0x291A (P223.00)	Deceleration time 2 (Decelerat.time 2) 0.0 ... [5.0] ... 3600.0 s	Deceleration time 2 for the operating mode "MS: Velocity mode". <ul style="list-style-type: none"> The deceleration time set refers to the deceleration from the maximum frequency set to standstill. In the case of a lower actual frequency, the actual deceleration time is reduced accordingly. The deceleration time 2 is active if the frequency setpoint (absolute value) \geq auto change-over threshold 0x291B (P224.00) or the trigger assigned to the function "Activate ramp 2" in 0x2631:039 (P400.39) = TRUE. The deceleration time 2 is also used for changing the MOP setpoint generated by the "motor potentiometer" function. Setting is not effective in the operating mode 0x6060 (P301.00) = "CiA: Velocity mode [2]". ▶ Device profile CiA 402 □ 426

Flexible I/O configuration

Activating ramp 2 manually



Example for operating mode

- Switch S1 starts the motor in forward direction of rotation. Switch S1 in the initial position stops the motor again.
- Switch S2 activates the acceleration time 2 and deceleration time 2.

Connection plan	function	
	Potentiometer R1	Frequency setpoint selection
	Switch S1	Run
	Switch S2	Activate ramp 2

Parameter	Name	Setting for this example
0x2631:001 (P400.01)	Enable inverter	Constant TRUE [1]
0x2631:002 (P400.02)	Run	Digital input 1 [11]
0x2631:004 (P400.04)	Reset fault	Not connected [0]
0x2631:039 (P400.39)	Activate ramp 2	Digital input 2 [12]
0x2824 (P200.00)	Control selection	Flexible I/O configuration [0]
0x2838:003 (P203.03)	Stop method	Standard ramp [1]
0x2860:001 (P201.01)	Frequency control: Default setpoint source	Analog input 1 [2]
0x2917 (P220.00)	Acceleration time 1	10.0 s
0x2918 (P221.00)	Deceleration time 1	10.0 s
0x2919 (P222.00)	Acceleration time 2	5.0 s
0x291A (P223.00)	Deceleration time 2	5.0 s

Input signals

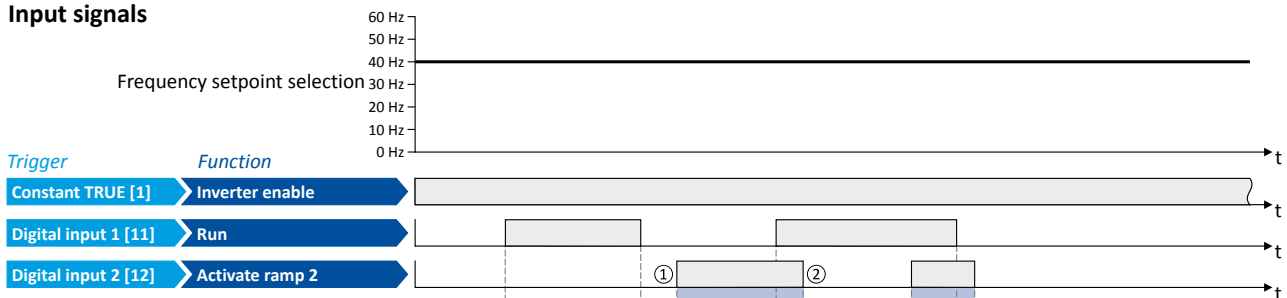

Output signals

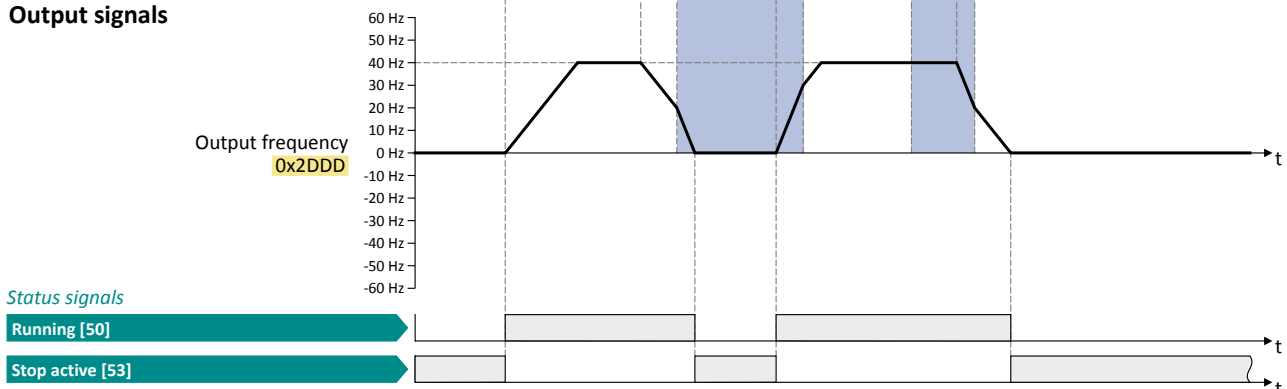

The status signals can be assigned to digital outputs. ▶ [Configuration of digital outputs](#) 574

- ① Change-over to deceleration time 2 during the deceleration phase.
- ② Change-over to acceleration time 1 during the acceleration phase.



13.8 Triggering a user-defined fault

The "Activate fault 1" and "Activate fault 2" functions serve to set the inverter from the process to the error status.

Details

If, for instance, sensors or switches are provided for process monitoring, which are designed to stop the process (and thus the drive) under certain conditions, these sensors/switches can be connected to free digital inputs of the inverter. The digital inputs used for the sensors/switches then have to be assigned to the functions "Activate fault 1" and "Activate fault 2" as triggers.

Parameter	Name / value range / [default setting]	Info
0x2631:043 (P400.43)	Function list: Activate fault 1 (Function list: Fault 1) <ul style="list-style-type: none"> For further possible settings, see parameter 0x2631:001 (P400.01). 500 	Assignment of a trigger for the "Activate fault 1" function. Trigger = TRUE: Trigger user-defined error 1. Trigger = FALSE: no action. Notes: <ul style="list-style-type: none"> After the error is triggered, the motor is brought to a standstill with the quick stop ramp. The inverter is then disabled. Associated error code: <ul style="list-style-type: none"> 25217 0x6281 - User-defined fault 1
	0 Not connected	No trigger assigned (trigger is constantly FALSE).
0x2631:044 (P400.44)	Function list: Activate fault 2 (Function list: Fault 2) <ul style="list-style-type: none"> For further possible settings, see parameter 0x2631:001 (P400.01). 500 	Assignment of a trigger for the "Activate fault 2" function. Trigger = TRUE: Trigger user-defined error 2. Trigger = FALSE: no action. Notes: <ul style="list-style-type: none"> After the error is triggered, the motor is brought to a standstill with the quick stop ramp. The inverter is then disabled. Associated error code: <ul style="list-style-type: none"> 25218 0x6282 - User-defined fault 2
	0 Not connected	No trigger assigned (trigger is constantly FALSE).

Example

An example of the operating mode can be found in the chapter "[Reset error](#)". [541](#)

Related topics

▶ [Error handling](#) [113](#)

Flexible I/O configuration

Functions for parameter change-over



13.9 Functions for parameter change-over

The inverter supports several parameter sets. The parameter set can be selected by means of the "Select parameter set (bit 0)" and "Select parameter set (bit 1)" functions.

⚠ DANGER!

Changed parameter settings can become effective immediately depending on the activating method set in [0x4046 \(P755.00\)](#).

The possible consequence is an unexpected response of the motor shaft while the inverter is enabled.

- ▶ If possible, only carry out parameter changes while the inverter is disabled.
- ▶ Certain device commands or settings which might cause a critical state of the drive behaviour can generally only be carried out when the inverter is inhibited.

Details

The "parameter change-over" function provides a change-over between four sets with different parameter values for up to 32 freely selectable parameters. For details on the compilation of the parameters and setting of the value sets, see the chapter "[Parameter change-over](#)".

[412](#)

A value set is selected in a binary-coded fashion via the triggers assigned to the two Select parameter set (bit 0)" and " Select parameter set (bit 1)" functions in compliance with the following truth table:

Select parameter set (bit 1) 0x2631:042 (P400.42)	Select parameter set (bit 0) 0x2631:041 (P400.41)	Selection
FALSE	FALSE	Value set 1
FALSE	TRUE	Value set 2
TRUE	FALSE	Value set 3
TRUE	TRUE	Value set 4

Change-over is effected depending on the activation method selected in [0x4046 \(P755.00\)](#) when a state change of the selection inputs takes place or via the trigger assigned to the "Load parameter set" function.

Parameter	Name / value range / [default setting]	Info
0x2631:040 (P400.40)	Function list: Load parameter set (Function list: Load param.set) <ul style="list-style-type: none"> • Setting can only be changed if the inverter is inhibited. • For further possible settings, see parameter 0x2631:001 (P400.01). 500 	Assignment of a trigger for the "Load parameter set" function. Trigger = FALSE-TRUE edge: parameter change-over to the value set selected via "Select parameter set (bit 0)" and "Select parameter set (bit 1)". Trigger = FALSE: no action. Notes: <ul style="list-style-type: none"> • The activation method for the "Parameter change-over" function can be selected in 0x4046 (P755.00).
	0 Not connected	No trigger assigned (trigger is constantly FALSE).
0x2631:041 (P400.41)	Function list: Select parameter set (bit 0) (Function list: Sel. paramset b0) <ul style="list-style-type: none"> • Setting can only be changed if the inverter is inhibited. • For further possible settings, see parameter 0x2631:001 (P400.01). 500 	Assignment of a trigger for the "Select parameter set (bit 0)" function. Selection bit with the valency 2^0 for "Parameter change-over" function. Trigger = FALSE: selection bit = "0". Trigger = TRUE: selection bit = "1".
	0 Not connected	No trigger assigned (trigger is constantly FALSE).
0x2631:042 (P400.42)	Function list: Select parameter set (bit 1) (Function list: Sel. paramset b1) <ul style="list-style-type: none"> • Setting can only be changed if the inverter is inhibited. • For further possible settings, see parameter 0x2631:001 (P400.01). 500 	Assignment of a trigger for the "Select parameter set (bit 1)" function. Selection bit with the valency 2^1 for "Parameter change-over" function. Trigger = FALSE: selection bit = "0". Trigger = TRUE: selection bit = "1".
	0 Not connected	No trigger assigned (trigger is constantly FALSE).



Flexible I/O configuration

Functions for parameter change-over

Parameter	Name / value range / [default setting]	Info
0x4046 (P755.00)	Activation of parameter set (PSet activation)	Selection of the activation method for the parameter change-over. <ul style="list-style-type: none"> If the selection is changed from "Via command... [0]/[1]" to "If the selection is changed...[2]/[3]" after switch-on, the parameter set selected via the functions "Select parameter set (bit 0)" and "Select parameter set (bit 1)" is activated immediately. In case of selection [2], however, this only takes place if the inverter is disabled, the motor is stopped or an error is active.
	0 Via command (disable required)	The parameter set selected via the functions "Select parameter set (bit 0)" and "Select parameter set (bit 1)" is activated if the trigger assigned to the "Load parameter set" function in 0x2631:040 (P400.40) provides a FALSE-TRUE edge AND the inverter is inhibited, the motor is stopped or an error is active.
	1 Via command (immediately)	The parameter set selected via the functions "Select parameter set (bit 0)" and "Select parameter set (bit 1)" is immediately activated if the trigger assigned to the "Load parameter set" function in 0x2631:040 (P400.40) provides a FALSE-TRUE edge.
	2 If the selection is changed (disable required)	The parameter set selected via the functions "Select parameter set (bit 0)" and "Select parameter set (bit 1)" is activated if the state of these selection bits changes AND the inverter is inhibited, the motor is stopped or an error is active.
	3 If the selection is changed (immediately)	The parameter set selected via the functions "Select parameter set (bit 0)" and "Select parameter set (bit 1)" is activated immediately if the state of these selection bits is changed.

Flexible I/O configuration

Functions for parameter change-over
 Example 1: Activation via command (only when disabled)

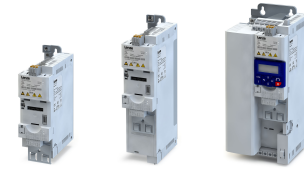

13.9.1 Example 1: Activation via command (only when disabled)

Activation method 0x4046 (P755.00) = "Via command (disable required) [0]":

- Switches S3 and S4 serve to select the parameter set (see the following table).
- Switch S2 activates the change-over. Since the change-over is activated with a rising edge, a button (normally-open contact) can be used instead of a switch.
- Change-over is only possible if the motor is not started (switch S1 open).

Connection plan	function															
	Switch S1 Run															
	Switch S2 Load parameter set															
	Switches S3 ... S4 Parameter set selection:															
	<table border="1"> <thead> <tr> <th>S3</th> <th>S4</th> <th></th> </tr> </thead> <tbody> <tr> <td>Off</td> <td>Off</td> <td>Parameter set 1</td> </tr> <tr> <td>On</td> <td>Off</td> <td>Parameter set 2</td> </tr> <tr> <td>Off</td> <td>On</td> <td>Parameter set 3</td> </tr> <tr> <td>On</td> <td>On</td> <td>Parameter set 4</td> </tr> </tbody> </table>	S3	S4		Off	Off	Parameter set 1	On	Off	Parameter set 2	Off	On	Parameter set 3	On	On	Parameter set 4
	S3	S4														
Off	Off	Parameter set 1														
On	Off	Parameter set 2														
Off	On	Parameter set 3														
On	On	Parameter set 4														

Parameter	Name	Setting for this example
0x2631:001 (P400.01)	Enable inverter	Constant TRUE [1]
0x2631:002 (P400.02)	Run	Digital input 1 [11]
0x2631:004 (P400.04)	Reset fault	Not connected [0]
0x2631:013 (P400.13)	Invert rotation	Not connected [0]
0x2631:018 (P400.18)	Activate preset (bit 0)	Not connected [0]
0x2631:040 (P400.40)	Load parameter set	Digital input 2 [12]
0x2631:041 (P400.41)	Select parameter set (bit 0)	Digital input 3 [13]
0x2631:042 (P400.42)	Select parameter set (bit 1)	Digital input 4 [14]
0x2824 (P200.00)	Control selection	Flexible I/O configuration [0]
0x4046 (P755.00)	Activation of parameter set	Via command (disable required) [0]

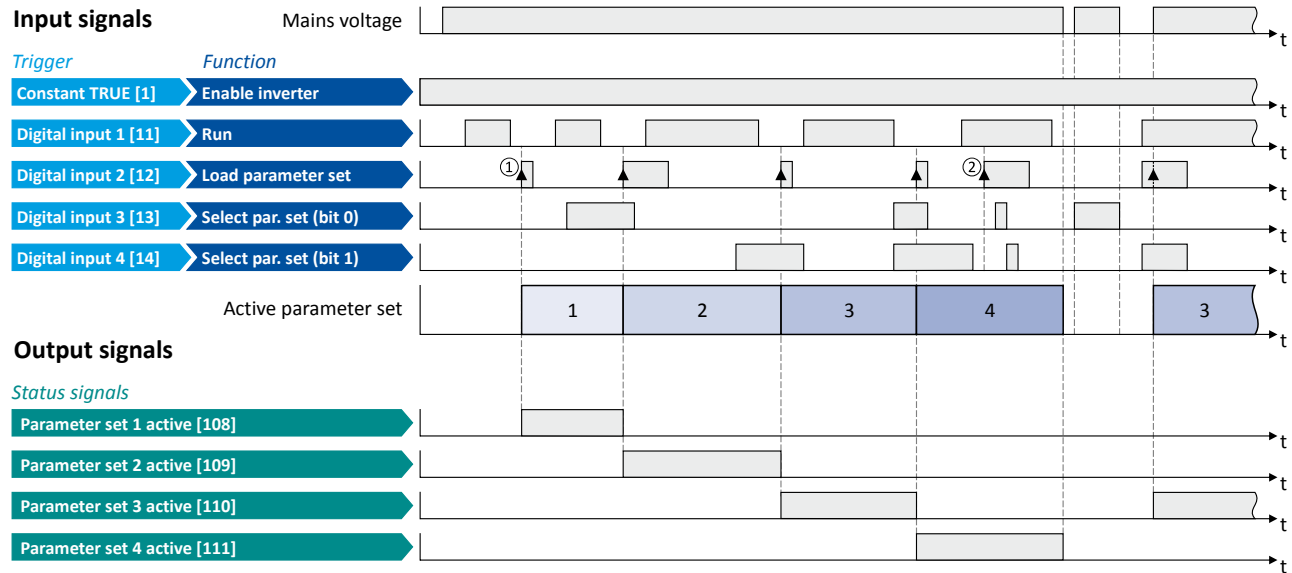

The status signals can be assigned to digital outputs. ▶ Configuration of digital outputs 574

- ① The change-over is activated with the "Load parameter set" function (FALSE/TRUE edge).
- ② If the inverter is enabled and the motor is started, a change-over is not possible.



Flexible I/O configuration

Functions for parameter change-over
Example 2: Activation via command (immediately)

13.9.2 Example 2: Activation via command (immediately)

Activation method 0x4046 (P755.00) = "Via command (immediately) [1]":

- Switches S3 and S4 serve to select the parameter set (see the following table).
- Switch S2 activates the change-over. Since the change-over is activated with a rising edge, a button (normally-open contact) can be used instead of a switch.
- Change-over takes place immediately, even if the motor is started (switch S1 closed).

Connection plan	function															
	Switch S1 Run															
	Switch S2 Load parameter set															
	Switches S3 ... S4 Parameter set selection:															
	<table border="1"> <thead> <tr> <th>S3</th> <th>S4</th> <th></th> </tr> </thead> <tbody> <tr> <td>Off</td> <td>Off</td> <td>Parameter set 1</td> </tr> <tr> <td>On</td> <td>Off</td> <td>Parameter set 2</td> </tr> <tr> <td>Off</td> <td>On</td> <td>Parameter set 3</td> </tr> <tr> <td>On</td> <td>On</td> <td>Parameter set 4</td> </tr> </tbody> </table>	S3	S4		Off	Off	Parameter set 1	On	Off	Parameter set 2	Off	On	Parameter set 3	On	On	Parameter set 4
	S3	S4														
Off	Off	Parameter set 1														
On	Off	Parameter set 2														
Off	On	Parameter set 3														
On	On	Parameter set 4														

Parameter	Name	Setting for this example
0x2631:001 (P400.01)	Enable inverter	Constant TRUE [1]
0x2631:002 (P400.02)	Run	Digital input 1 [11]
0x2631:004 (P400.04)	Reset fault	Not connected [0]
0x2631:018 (P400.18)	Activate preset (bit 0)	Not connected [0]
0x2631:040 (P400.40)	Load parameter set	Digital input 2 [12]
0x2631:041 (P400.41)	Select parameter set (bit 0)	Digital input 3 [13]
0x2631:042 (P400.42)	Select parameter set (bit 1)	Digital input 4 [14]
0x2824 (P200.00)	Control selection	Flexible I/O configuration [0]
0x4046 (P755.00)	Activation of parameter set	Via command (immediately) [1]

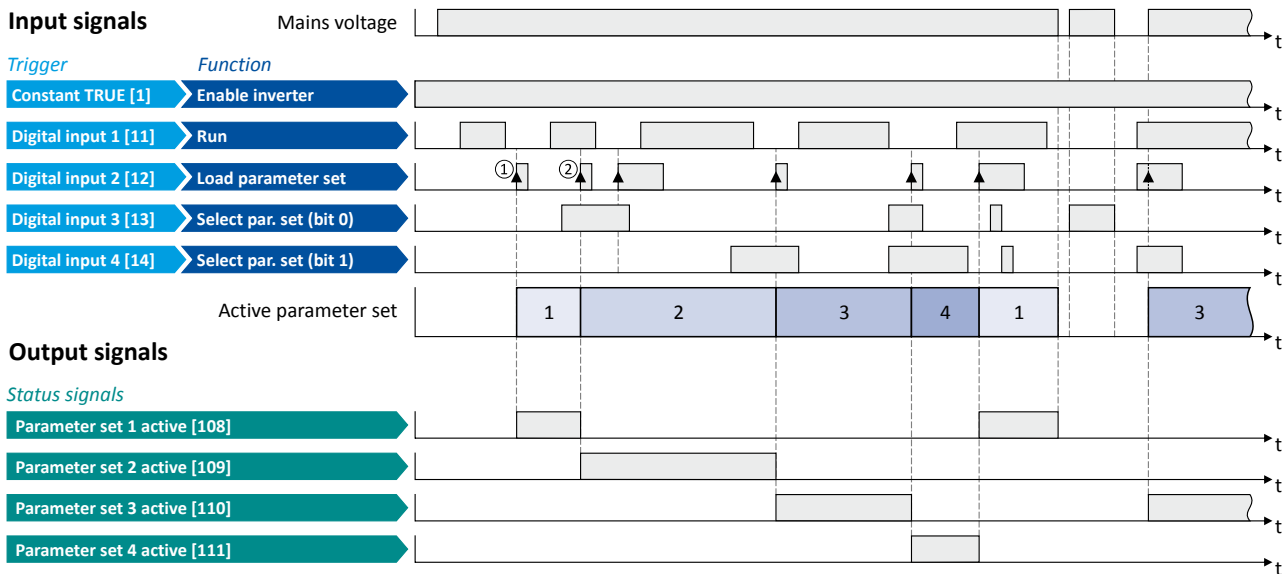

The status signals can be assigned to digital outputs. ▶ [Configuration of digital outputs](#) 574

- ① The change-over is activated with the "Load parameter set" function (FALSE/TRUE edge).
- ② Change-over is also possible if the inverter is enabled and the motor is started.

Flexible I/O configuration

Functions for parameter change-over

Example 3: Activation if the selection is changed (only if the inverter is disabled)

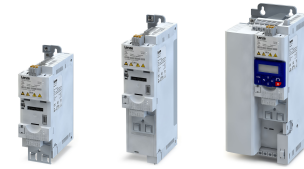

13.9.3 Example 3: Activation if the selection is changed (only if the inverter is disabled)

Activation method 0x4046 (P755.00) = "If the selection is changed (disable required) [2]":

- Switches S3 and S4 serve to select the parameter set (see the following table). At the same time, the change-over is activated by a status change of the selection inputs.
- Change-over is only possible if the motor is not started (switch S1 open).
- Switch S2 ("Load parameter set") is ignored in this configuration.

Connection plan	function															
	Switch S1 Run															
	Switch S2 Load parameter set (is ignored in this configuration)															
	Switches S3 ... S4 Parameter set selection and activation at the same time:															
	<table border="1"> <thead> <tr> <th>S3</th> <th>S4</th> <th>Parameter set</th> </tr> </thead> <tbody> <tr> <td>Off</td> <td>Off</td> <td>Parameter set 1</td> </tr> <tr> <td>On</td> <td>Off</td> <td>Parameter set 2</td> </tr> <tr> <td>Off</td> <td>On</td> <td>Parameter set 3</td> </tr> <tr> <td>On</td> <td>On</td> <td>Parameter set 4</td> </tr> </tbody> </table>	S3	S4	Parameter set	Off	Off	Parameter set 1	On	Off	Parameter set 2	Off	On	Parameter set 3	On	On	Parameter set 4
	S3	S4	Parameter set													
Off	Off	Parameter set 1														
On	Off	Parameter set 2														
Off	On	Parameter set 3														
On	On	Parameter set 4														

Parameter	Name	Setting for this example
0x2631:001 (P400.01)	Enable inverter	Constant TRUE [1]
0x2631:002 (P400.02)	Run	Digital input 1 [11]
0x2631:004 (P400.04)	Reset fault	Not connected [0]
0x2631:013 (P400.13)	Invert rotation	Not connected [0]
0x2631:018 (P400.18)	Activate preset (bit 0)	Not connected [0]
0x2631:040 (P400.40)	Load parameter set	Digital input 2 [12]
0x2631:041 (P400.41)	Select parameter set (bit 0)	Digital input 3 [13]
0x2631:042 (P400.42)	Select parameter set (bit 1)	Digital input 4 [14]
0x2824 (P200.00)	Control selection	Flexible I/O configuration [0]
0x4046 (P755.00)	Activation of parameter set	If the selection is changed (disable required) [2]

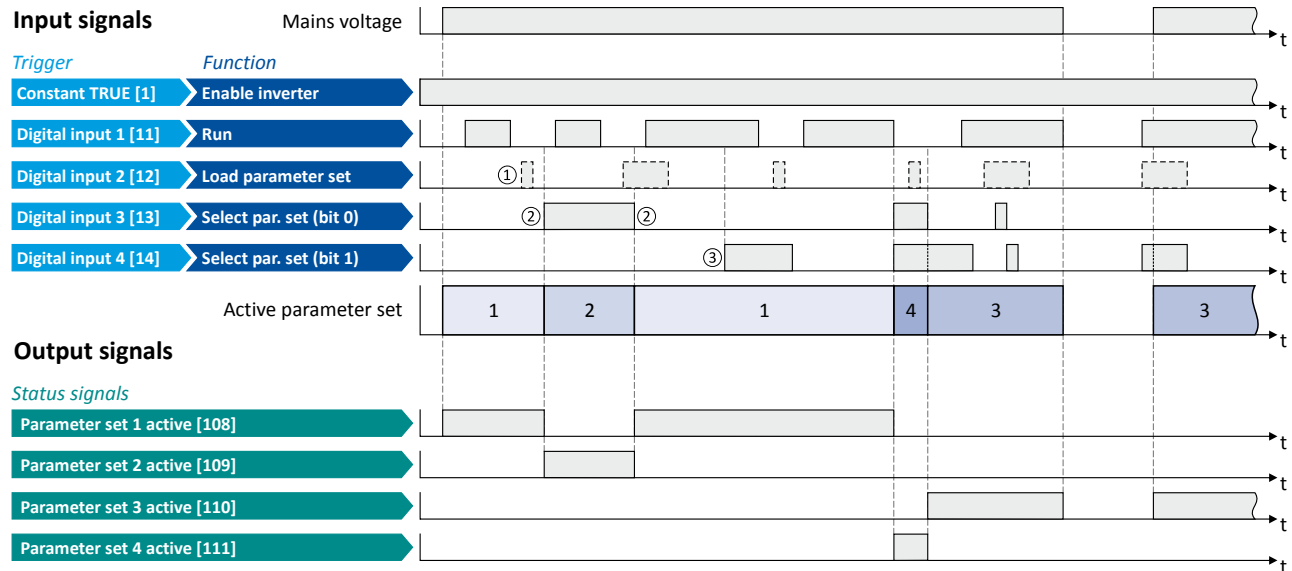

The status signals can be assigned to digital outputs. [► Configuration of digital outputs 574](#)

- ① The "Load parameter set" function is ignored in this configuration.
- ② Change-over takes place by a status change of the selection inputs.
- ③ If the inverter is enabled and the motor is started, a change-over is not possible.

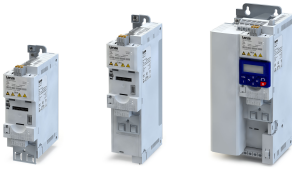

Flexible I/O configuration

Functions for parameter change-over
 Example 4: Activation if the selection is changed (immediately)

13.9.4 Example 4: Activation if the selection is changed (immediately)

Activation method 0x4046 (P755.00) = "If the selection is changed (immediately) [3]":

- Switches S3 and S4 serve to select the parameter set (see the following table). At the same time, the change-over is activated by a status change of the selection inputs.
- Change-over takes place immediately, even if the motor is started (switch S1 closed).
- Switch S2 ("Load parameter set") is ignored in this configuration.

Connection plan	function															
	Switch S1 Run															
	Switch S2 Load parameter set (is ignored in this configuration)															
	Switches S3 ... S4 Parameter set selection and activation at the same time:															
	<table border="1"> <thead> <tr> <th>S3</th> <th>S4</th> <th></th> </tr> </thead> <tbody> <tr> <td>Off</td> <td>Off</td> <td>Parameter set 1</td> </tr> <tr> <td>On</td> <td>Off</td> <td>Parameter set 2</td> </tr> <tr> <td>Off</td> <td>On</td> <td>Parameter set 3</td> </tr> <tr> <td>On</td> <td>On</td> <td>Parameter set 4</td> </tr> </tbody> </table>	S3	S4		Off	Off	Parameter set 1	On	Off	Parameter set 2	Off	On	Parameter set 3	On	On	Parameter set 4
	S3	S4														
Off	Off	Parameter set 1														
On	Off	Parameter set 2														
Off	On	Parameter set 3														
On	On	Parameter set 4														

Parameter	Name	Setting for this example
0x2631:001 (P400.01)	Enable inverter	Constant TRUE [1]
0x2631:002 (P400.02)	Run	Digital input 1 [11]
0x2631:004 (P400.04)	Reset fault	Not connected [0]
0x2631:013 (P400.13)	Invert rotation	Not connected [0]
0x2631:018 (P400.18)	Activate preset (bit 0)	Not connected [0]
0x2631:040 (P400.40)	Load parameter set	Digital input 2 [12]
0x2631:041 (P400.41)	Select parameter set (bit 0)	Digital input 3 [13]
0x2631:042 (P400.42)	Select parameter set (bit 1)	Digital input 4 [14]
0x2824 (P200.00)	Control selection	Flexible I/O configuration [0]
0x4046 (P755.00)	Activation of parameter set	If the selection is changed (immediately) [3]

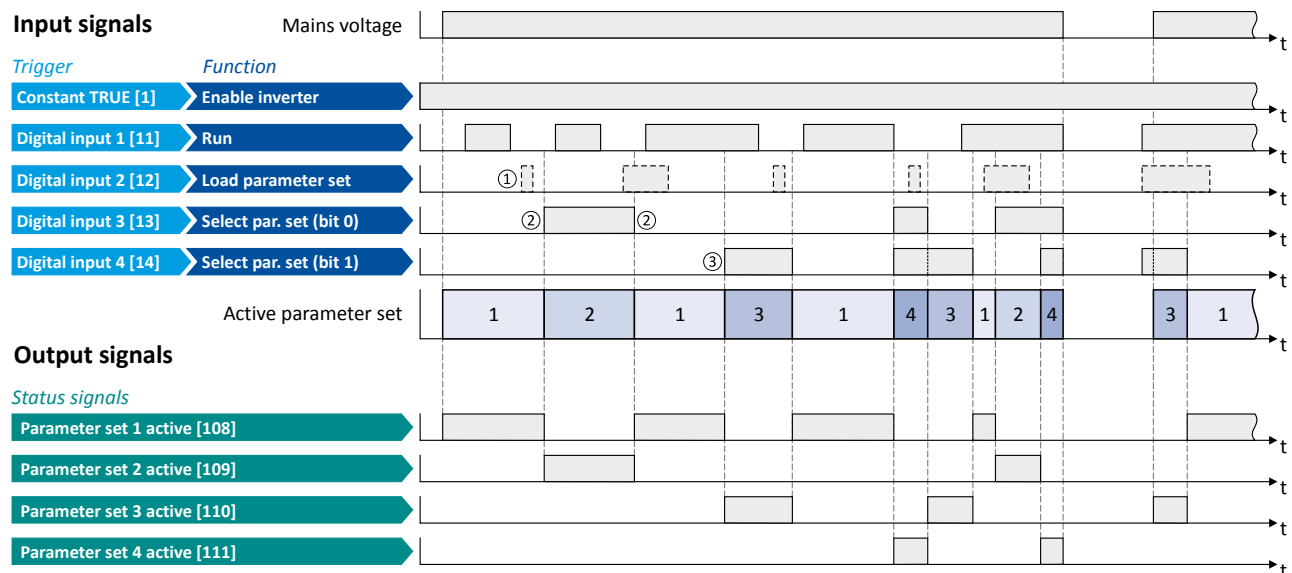

The status signals can be assigned to digital outputs. ▶ [Configuration of digital outputs](#) 574

- ① The "Load parameter set" function is ignored in this configuration.
- ② Change-over takes place by a status change of the selection inputs.
- ③ Change-over is also possible if the inverter is enabled and the motor is started.

Flexible I/O configuration

Process controller function selection



13.10 Process controller function selection

By means of the following functions, the response of the inverter can be controlled when PID control is activated. ▶ [Configuring the process controller](#) 356

Parameter	Name / value range / [default setting]	Info
0x2631:045 (P400.45)	Function list: Deactivate PID controller (Function list: PID off) • For further possible settings, see parameter 0x2631:001 (P400.01) . 500	Assignment of a trigger for the "Deactivate PID controller" function. Trigger = TRUE: If PID control is activated, ignore PID control and drive the motor in speed-controlled manner. Trigger = FALSE: If PID control is activated, drive the motor with PID control. Notes: • The PID control mode can be selected in 0x4020:001 (P600.01) .
	0 Not connected	No trigger assigned (trigger is constantly FALSE).
0x2631:046 (P400.46)	Function list: Set process controller output to 0 (Function list: PID output=0) • For further possible settings, see parameter 0x2631:001 (P400.01) . 500	Assignment of a trigger for the "Set process controller output to 0" function. Trigger = TRUE: If PID control is activated, I component and the output of the PID controller are set to 0 and the internal control algorithm is stopped. The PID control remains active. Trigger = FALSE: no action / deactivate function again.
	0 Not connected	No trigger assigned (trigger is constantly FALSE).
0x2631:047 (P400.47)	Function list: Inhibit process controller I-component (Function list: PID-I inhibited) • For further possible settings, see parameter 0x2631:001 (P400.01) . 500	Assignment of a trigger for the "Inhibit process controller I-component" function. Trigger = TRUE: If PID control is activated, the I component of the PID controller is set to 0 and the integration process is stopped. Trigger = FALSE: no action / deactivate function again. Notes: • The reset time can be set in 0x4049 (P602.00) .
	0 Not connected	No trigger assigned (trigger is constantly FALSE).
0x2631:048 (P400.48)	Function list: Activate process controller influence ramp (Function list: PID-Inf ramp on) • For further possible settings, see parameter 0x2631:001 (P400.01) . 500	Assignment of a trigger for the "Activate process controller influence ramp" function. Trigger = TRUE: the influence of the process controller is shown via a ramp. Trigger = FALSE or not connected: the influence of the process controller is hidden via ramp. Notes: • The influence of the process controller is always active (not only when PID control is activated). • Acceleration time for showing the influence of the process controller can be set in 0x404C:001 (P607.01) . • Deceleration time for hiding the influence of the process controller can be set in 0x404C:002 (P607.02) .
	1 Constant TRUE	Trigger is constantly TRUE.
0x4020:001 (P600.01)	Process controller setup (PID): Operating mode (PID setup: Operating mode)	Selection of the process controller operating mode.
	0 Inhibited	Process controller deactivated.
	1 Normal operation	The setpoint is higher than the fed back variable (actual value). If the system deviation increases, the motor speed is increased. Example: pressure-controlled booster pumps (increase in the motor speed produces an increase in pressure.)
	2 Reverse operation	The setpoint is lower than the fed back variable (actual value). If the system deviation increases, the motor speed is increased. Example: temperature-controlled cooling water pump (increase in motor speed produces decrease in temperature.)
	3 Normal bi-directional	The direction of rotation corresponds to the sign of the system deviation. If the system deviation increases, the motor speed is increased.
4 Reverse bi-directional	A negative system deviation causes a positive direction of rotation. If the system deviation increases, the motor speed is increased.	
0x4049 (P602.00)	PID I- component (PID I- component) 10 ... [400] ... 6000 ms	Reset time for system deviation. • With the setting "6000 ms", the I component is deactivated. • The I component can also be deactivated via the "Inhibit process controller I-component" 0x2631:047 (P400.47) function.



Parameter	Name / value range / [default setting]	Info
0x404C:001 (P607.01)	PID influence: Acceleration time for showing (PID influence: Show time) 0.0 ... [5.0] ... 999.9 s	If the trigger assigned in 0x2631:048 (P400.48) of the "Activate process controller influence ramp" function is TRUE, the influence of the process controller is shown by means of a ramp with the acceleration time set here.
0x404C:002 (P607.02)	PID influence: Deceleration time for masking out (PID influence: Mask out time) 0.0 ... [5.0] ... 999.9 s	If the trigger assigned in 0x2631:048 (P400.48) of the "Activate process controller influence ramp" function is FALSE, the influence of the process controller is hidden via a ramp with the deceleration time set here.

Example for operating mode

In the following example, the "Deactivate PID controller" function is used to deactivate the PID control temporarily:

- As standard setpoint source, the frequency preset 1 is set to 20 Hz.
- Switch S1 starts the motor in forward direction of rotation. Switch S1 in the initial position stops the motor again.
- Switch S2 deactivates the PID control. The motor is then driven in a speed-controlled way.

Connection plan	function
	Switch S1 Run
	Switch S2 Deactivate PID controller

Parameter	Name	Setting for this example
0x2631:001 (P400.01)	Enable inverter	Constant TRUE [1]
0x2631:002 (P400.02)	Run	Digital input 1 [11]
0x2631:004 (P400.04)	Reset fault	Not connected [0]
0x2631:045 (P400.45)	Deactivate PID controller	Digital input 2 [12]
0x2824 (P200.00)	Control selection	Flexible I/O configuration [0]
0x2838:003 (P203.03)	Stop method	Standard ramp [1]
0x2860:001 (P201.01)	Frequency control: Default setpoint source	Frequency preset 1 [11]
0x2911:001 (P450.01)	Frequency setpoint presets: Preset 1	20 Hz
0x2916 (P211.00)	Maximum frequency	50 Hz



The example assumes that the process controller has been configured accordingly. ▶ [Configuring the process controller](#) 356

Flexible I/O configuration

Process controller function selection



Input signals

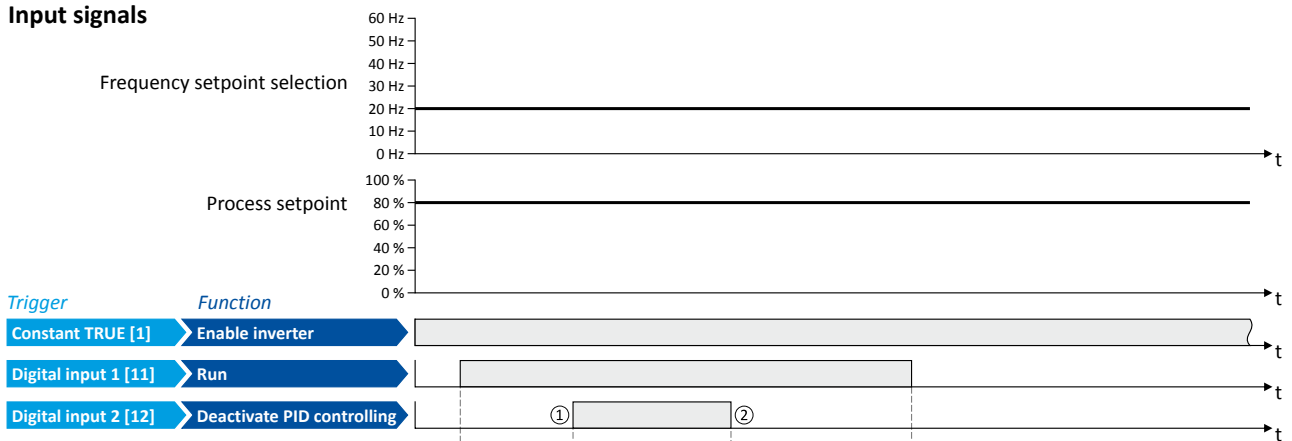

Output signals

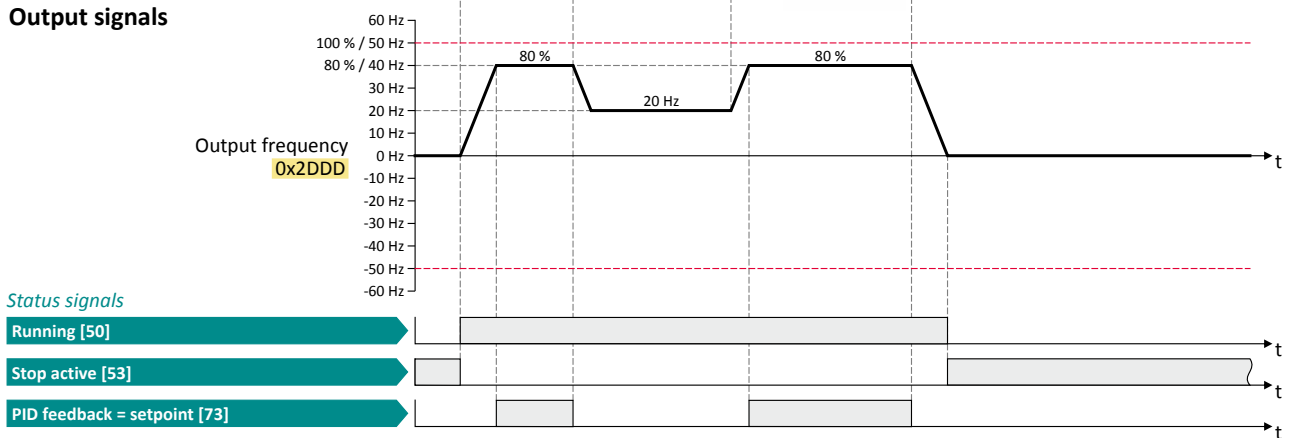

The status signals can be assigned to digital outputs. ▶ [Configuration of digital outputs](#) □ 574

- ① PID control is deactivated: Change-over from the configured PID control to the speed-controlled operation.
- ② PID control is activated again: Change-over from the speed-controlled operation to the configured PID control.



13.11 Sequencer control functions

The following functions serve to control the sequencer. ▶ [Sequencer](#) 462

Select sequence

A sequence is selected in a binary-coded fashion via the triggers assigned to the four functions "Select sequence (bit 0)" ... "Select sequence (bit 3)" in compliance with the following truth table:

Select sequence				Selection
Bit 3 0x2631:053 (P400.53)	Bit 2 0x2631:052 (P400.52)	Bit 1 0x2631:051 (P400.51)	Bit 0 0x2631:050 (P400.50)	
FALSE	FALSE	FALSE	FALSE	No sequence selected
FALSE	FALSE	FALSE	TRUE	Sequence 1
FALSE	FALSE	TRUE	FALSE	Sequence 2
FALSE	FALSE	TRUE	TRUE	Sequence 3
FALSE	TRUE	FALSE	FALSE	Sequence 4
FALSE	TRUE	FALSE	TRUE	Sequence 5
FALSE	TRUE	TRUE	FALSE	Sequence 6
FALSE	TRUE	TRUE	TRUE	Sequence 7
TRUE	FALSE	FALSE	FALSE	Sequence 8
TRUE	FALSE	FALSE	TRUE	Invalid selection
...				
TRUE	TRUE	TRUE	TRUE	

Start sequence

The selected sequence is not started automatically. For starting the sequence, two functions are available:

- [0x2631:030 \(P400.30\)](#): Run/abort sequence (status-controlled start)
- [0x2631:031 \(P400.31\)](#): Start sequence (edge-controlled start)

Further control functions

The following functions serve to control the started sequence:

- [0x2631:032 \(P400.32\)](#): Next sequence step
- [0x2631:033 \(P400.33\)](#): Pause sequence
- [0x2631:034 \(P400.34\)](#): Suspend sequence
- [0x2631:035 \(P400.35\)](#): Stop sequence
- [0x2631:036 \(P400.36\)](#): Abort sequence

For controlling the sequencer via network, the sequencer control functions can also be assigned to the NetWordIN1 data word [0x4008:001 \(P590.01\)](#).

Parameter	Name / value range / [default setting]	Info
0x2631:030 (P400.30)	Function list: Run/abort sequence (Function list: Seq: Run/abort)	Assignment of a trigger for the "Run/abort sequence" function. Trigger = TRUE: Start selected sequence. Trigger = FALSE: Abort sequence.
	<ul style="list-style-type: none"> • Setting can only be changed if the inverter is inhibited. • From version 03.00 • For further possible settings, see parameter 0x2631:001 (P400.01). 500 	Notes: <ul style="list-style-type: none"> • The assigned trigger must remain set to TRUE for the duration of the sequence. • If the trigger bit is reset to FALSE, the sequence is aborted. In this case, the standard setpoint or the setpoint source selected via setpoint change-over is active again. • A sequence is selected in a binary-coded fashion via the trigger assigned to the four functions "Select sequence (bit 0)" 0x2631:050 (P400.50) ... "Select sequence (bit 3)" 0x2631:053 (P400.53). • For an edge-controlled start, the function "Start sequence" 0x2631:031 (P400.31) is optionally available.
	0 Not connected	No trigger assigned (trigger is constantly FALSE).

Flexible I/O configuration

Sequencer control functions



Parameter	Name / value range / [default setting]	Info
0x2631:031 (P400.31)	Function list: Start sequence (Function list: Seq: Start) <ul style="list-style-type: none"> Setting can only be changed if the inverter is inhibited. From version 03.00 For further possible settings, see parameter 0x2631:001 (P400.01). 500 	Assignment of a trigger for the "Start sequence" function. Trigger = FALSE \nearrow TRUE (edge): Start selected sequence. Trigger = TRUE \searrow FALSE (edge): No action. Notes: <ul style="list-style-type: none"> After the start, the sequencer remains activated until the function "Stop sequence" 0x2631:035 (P400.35) or the function "Abort sequence" 0x2631:036 (P400.36) is executed. A normal stop command does not reset the start command for the sequencer. For a status-controlled start, the function "Run/abort sequence" 0x2631:030 (P400.30) is optionally available.
	0 Not connected	No trigger assigned (trigger is constantly FALSE).
0x2631:032 (P400.32)	Function list: Next sequence step (Function list: Seq: Next step) <ul style="list-style-type: none"> Setting can only be changed if the inverter is inhibited. From version 03.00 For further possible settings, see parameter 0x2631:001 (P400.01). 500 	Assignment of a trigger for the "Next sequence step" function. Trigger = FALSE \nearrow TRUE (edge): Next sequence step. Trigger = TRUE \searrow FALSE (edge): No action. Notes: <ul style="list-style-type: none"> The execution of the current step is completed even if the time parameterised for the segment has not elapsed yet. The function is only relevant for Sequencer mode 0x4025 (P800.00) = "Step operation [2]" or "Time & step operation [3]". A jump to the next sequence step is not possible if the sequence pauses, the sequence is suspended or the final segment is executed.
	0 Not connected	No trigger assigned (trigger is constantly FALSE).
0x2631:033 (P400.33)	Function list: Pause sequence (Function list: Seq: Pause) <ul style="list-style-type: none"> Setting can only be changed if the inverter is inhibited. From version 03.00 For further possible settings, see parameter 0x2631:001 (P400.01). 500 	Assignment of a trigger for the "Pause sequence" function. Trigger = TRUE: Pause sequence. Trigger = FALSE: Continue sequence. Notes: <ul style="list-style-type: none"> During the pause, the sequence stops in the current step. The expiration of the time set for the segment is stopped. The sequencer setpoint continues to remain active.
	0 Not connected	No trigger assigned (trigger is constantly FALSE).
0x2631:034 (P400.34)	Function list: Suspend sequence (Function list: Seq: Suspense) <ul style="list-style-type: none"> Setting can only be changed if the inverter is inhibited. From version 03.00 For further possible settings, see parameter 0x2631:001 (P400.01). 500 	Assignment of a trigger for the "Suspend sequence" function. Trigger = TRUE: Suspend sequence. Trigger = FALSE: Continue sequence. Notes: <ul style="list-style-type: none"> This function serves to temporarily change over to the standard setpoint or the setpoint source selected via setpoint change-over. The sequence is continued at the point where it was suspended.
	0 Not connected	No trigger assigned (trigger is constantly FALSE).
0x2631:035 (P400.35)	Function list: Stop sequence (Function list: Seq: Stop) <ul style="list-style-type: none"> Setting can only be changed if the inverter is inhibited. From version 03.00 For further possible settings, see parameter 0x2631:001 (P400.01). 500 	Assignment of a trigger for the "Stop sequence" function. Trigger = FALSE \nearrow TRUE (edge): Stop sequence. Trigger = TRUE \searrow FALSE (edge): No action. Notes: <ul style="list-style-type: none"> If the sequence is stopped, it is jumped to the final segment. The further execution depends on the selected End of sequence mode 0x402F (P824.00).
	0 Not connected	No trigger assigned (trigger is constantly FALSE).
0x2631:036 (P400.36)	Function list: Abort sequence (Function list: Seq: Abort) <ul style="list-style-type: none"> Setting can only be changed if the inverter is inhibited. From version 03.00 For further possible settings, see parameter 0x2631:001 (P400.01). 500 	Assignment of a trigger for the "Abort sequence" function. Trigger = FALSE \nearrow TRUE (edge): Abort sequence. Trigger = TRUE \searrow FALSE (edge): No action. Notes: <ul style="list-style-type: none"> This function serves to directly stop the sequence without the final segment being executed. In this case, the standard setpoint or the setpoint source selected via setpoint change-over is active again.
	0 Not connected	No trigger assigned (trigger is constantly FALSE).



Flexible I/O configuration

Sequencer control functions

Parameter	Name / value range / [default setting]	Info
0x2631:050 (P400.50)	Function list: Select sequence (bit 0) (Function list: Seq: Select. b0) <ul style="list-style-type: none"> Setting can only be changed if the inverter is inhibited. From version 03.00 For further possible settings, see parameter 0x2631:001 (P400.01). 500 	Assignment of a trigger for the "Select sequence (bit 0)" function. Selection bit with the valency 2^0 for bit coded selection of a sequence. Trigger = FALSE: selection bit = "0". Trigger = TRUE: selection bit = "1". Notes: <ul style="list-style-type: none"> The selected sequence is not started automatically. For a status-controlled start, the function "Run/abort sequence" 0x2631:030 (P400.30) is available. For an edge-controlled start, the function "Start sequence" 0x2631:031 (P400.31) is available.
	0 Not connected	No trigger assigned (trigger is constantly FALSE).
0x2631:051 (P400.51)	Function list: Select sequence (bit 1) (Function list: Seq: Select. b1) <ul style="list-style-type: none"> Setting can only be changed if the inverter is inhibited. From version 03.00 For further possible settings, see parameter 0x2631:001 (P400.01). 500 	Assignment of a trigger for the "Select sequence (bit 1)" function. Selection bit with the valency 2^1 for the bit-coded selection of a sequence. Trigger = FALSE: selection bit = "0". Trigger = TRUE: selection bit = "1". Notes: <ul style="list-style-type: none"> The selected sequence is not started automatically. For a status-controlled start, the function "Run/abort sequence" 0x2631:030 (P400.30) is available. For an edge-controlled start, the function "Start sequence" 0x2631:031 (P400.31) is available.
	0 Not connected	No trigger assigned (trigger is constantly FALSE).
0x2631:052 (P400.52)	Function list: Select sequence (bit 2) (Function list: Seq: Select. b2) <ul style="list-style-type: none"> Setting can only be changed if the inverter is inhibited. From version 03.00 For further possible settings, see parameter 0x2631:001 (P400.01). 500 	Assignment of a trigger for the "Select sequence (bit 2)" function. Selection bit with the valency 2^2 for the bit-coded selection of a sequence. Trigger = FALSE: selection bit = "0". Trigger = TRUE: selection bit = "1". Notes: <ul style="list-style-type: none"> The selected sequence is not started automatically. For a status-controlled start, the function "Run/abort sequence" 0x2631:030 (P400.30) is available. For an edge-controlled start, the function "Start sequence" 0x2631:031 (P400.31) is available.
	0 Not connected	No trigger assigned (trigger is constantly FALSE).
0x2631:053 (P400.53)	Function list: Select sequence (bit 3) (Function list: Seq: Select. b3) <ul style="list-style-type: none"> Setting can only be changed if the inverter is inhibited. From version 03.00 For further possible settings, see parameter 0x2631:001 (P400.01). 500 	Assignment of a trigger for the "Select sequence (bit 3)" function. Selection bit with the valency 2^3 for the bit-coded selection of a sequence. Trigger = FALSE: selection bit = "0". Trigger = TRUE: selection bit = "1". Notes: <ul style="list-style-type: none"> The selected sequence is not started automatically. For a status-controlled start, the function "Run/abort sequence" 0x2631:030 (P400.30) is available. For an edge-controlled start, the function "Start sequence" 0x2631:031 (P400.31) is available.
	0 Not connected	No trigger assigned (trigger is constantly FALSE).

Flexible I/O configuration

Sequencer control functions



Example for operating mode

In the following example, the digital inputs 2 and 3 are used for controlling the sequencer.

- The analog input 1 is set as standard setpoint source.
- Switch S1 starts the motor in forward direction of rotation. Switch S1 in the initial position stops the motor again.
- Button S2 starts the sequence, button S3 aborts the sequence. After the abortion, the normal setpoint control is active again.

Connection plan	Function	
	Potentiometer R1	Frequency setpoint selection
	Switch S1	Run
	Button S2	Start sequence
	Button S3	Abort sequence

Parameter	Name	Setting for this example
0x2631:001 (P400.01)	Enable inverter	Constant TRUE [1]
0x2631:002 (P400.02)	Run	Digital input 1 [11]
0x2631:004 (P400.04)	Reset fault	Not connected [0]
0x2631:013 (P400.13)	Invert rotation	Not connected [0]
0x2631:031 (P400.31)	Start sequence	Digital input 2 [12]
0x2631:036 (P400.36)	Abort sequence	Digital input 3 [13]
0x2631:050 (P400.50)	Select sequence (bit 0)	Constant TRUE [1]
0x2634:001 (P420.01)	Relay	Sequencer controlled [100]
0x2634:002 (P420.02)	Digital output 1	Sequencer controlled [100]

Segment and sequence configuration

In this example, only the sequence 1 is used. The sequence consists of two steps (segment 1 and segment 2).

0x4026:001 (P801.01)	Sequencer segment 1: Frequency setpoint	40 Hz
0x4026:002 (P801.02)	Sequencer segment 1: Acceleration/deceleration	20 s
0x4026:003 (P801.03)	Sequencer segment 1: Time	18 s
0x4026:004 (P801.04)	Sequencer segment 1: Digital outputs	0x00
0x4027:001 (P802.01)	Sequencer segment 2: Frequency setpoint	30 Hz
0x4027:002 (P802.02)	Sequencer segment 2: Acceleration/deceleration	15 s
0x4027:003 (P802.03)	Sequencer segment 2: Time	14 s
0x4027:004 (P802.04)	Sequencer segment 2: Digital outputs	0x02 (only relay)
0x402E:001 (P822.01)	End segment: Frequency setpoint	10 Hz
0x402E:002 (P822.02)	End segment: Acceleration/deceleration	8 s
0x402E:003 (P822.03)	End segment: Time	10 s
0x402E:004 (P822.04)	End segment: Digital outputs	0x04 (only digital output 1)
0x4030:001 (P830.01)	Sequence 1: Step 1	Segment 1 [1]
0x4030:002 (P830.02)	Sequence 1: Step 2	Segment 2 [2]

Sequencer basic settings

0x4025 (P800.00)	Sequencer mode	Time operation [1]
0x402F (P824.00)	End of sequence mode	Keep running [0]
0x4040 (P820.00)	Start of sequence mode	Restart sequencer [0]

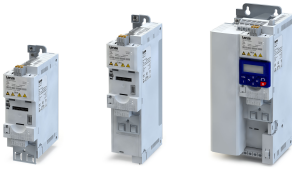

Flexible I/O configuration

Sequencer control functions

Input signals

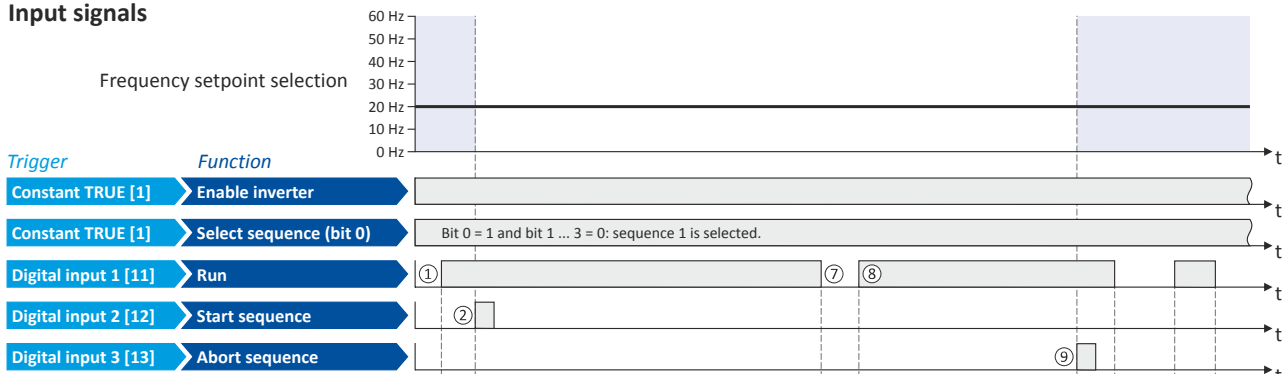

Output signals

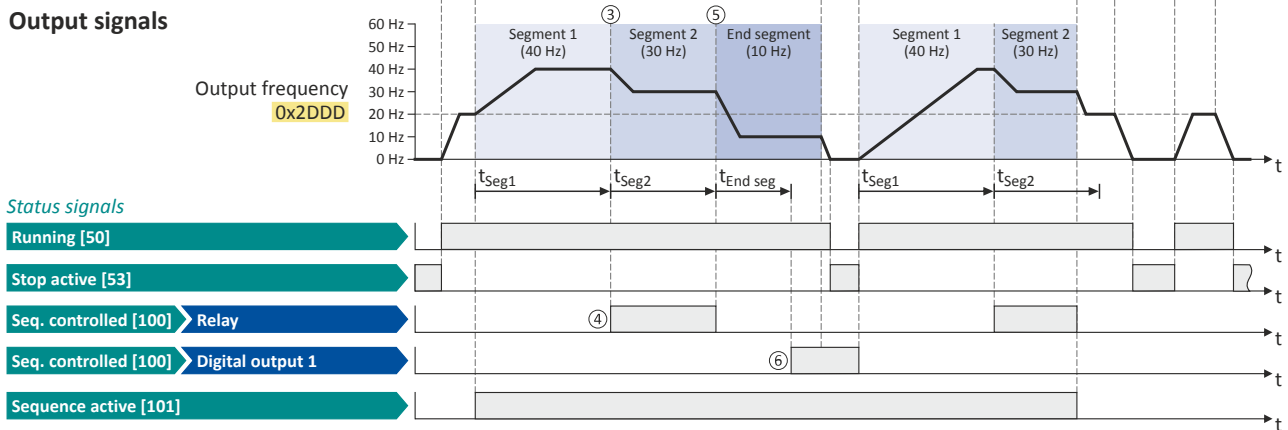

The status signals can be assigned to digital outputs. ▶ [Configuration of digital outputs](#) 574

- ① If the inverter is enabled and no error is active, the motor can be started with the "Run" function. As the sequence has not been started yet, first the normal setpoint control is active.
- ② The "Start sequence" function is used to start the selected sequence in an edge-controlled way.
- ③ Sequencer mode `0x4025 (P800.00)` = "Time operation [1]":
The switch-over to the next step of the sequence is made after the time set for the current segment has elapsed.
- ④ The segment 2 is configured here in such a way that the relay will be triggered during the time of processing.
- ⑤ End of sequence mode `0x402F (P824.00)` = "Keep running [0]":
After the sequence has been processed, the setpoint set for the end segment is continuously transmitted to the motor control until the sequence is aborted.
- ⑥ In case of the end segment, the time setting determines the delay after which the configured output states are to become active. Here, the end segment is configured in such a way that the digital output 1 is set after 10 s have expired.
- ⑦ If the "Run" function is set to FALSE, the motor is stopped with the stop method set in `0x2838:003 (P203.03)`. The started sequence, however, remains active and the sequencer-controlled outputs keep their state.
- ⑧ Start of sequence mode `0x4040 (P820.00)` = "Restart sequencer [0]":
If the "Run" function is set to TRUE again, the (still active) sequence is restarted.
- ⑨ The "Abort sequence" function is used to abort the sequence in an edge-controlled way.
In this case, the standard setpoint or the setpoint source selected via setpoint change-over is active again.

Flexible I/O configuration

Frequency threshold for "Frequency threshold exceeded" trigger

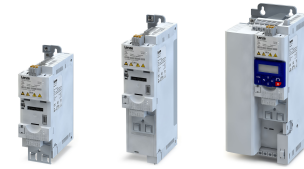

13.12 Frequency threshold for "Frequency threshold exceeded" trigger

As a function of the current output frequency, the adjustable frequency threshold serves to trigger a certain function or set a digital output.

Parameter	Name / value range / [default setting]	Info
0x4005 (P412.00)	Frequency threshold (Freq. threshold) 0.0 ... [0.0] ... 599.0 Hz	Threshold for the "Frequency threshold exceeded [70]" trigger. <ul style="list-style-type: none"> The "Frequency threshold exceeded [70]" trigger is TRUE if the current output frequency is higher than the set threshold. The trigger can be assigned to a function or to a digital output.

Example for operating mode

In the following example, the digital output 1 is set to TRUE if the output frequency is higher than 20 Hz.

- The analog input 1 is set as standard setpoint source.
- Switch S1 starts the motor in forward direction of rotation. Switch S1 in the initial position stops the motor again.

Connection plan	Function
	Potentiometer R1: Frequency setpoint selection
	Switch S1: Run

Parameter	Name	Setting for this example
0x2631:001 (P400.01)	Enable inverter	Constant TRUE [1]
0x2631:002 (P400.02)	Run	Digital input 1 [11]
0x2634:002 (P420.02)	Digital outputs function: Digital output 1	Frequency threshold exceeded [70]
0x2824 (P200.00)	Control selection	Flexible I/O configuration [0]
0x2860:001 (P201.01)	Frequency control: Default setpoint source	Analog input 1 [2]
0x4005 (P412.00)	Frequency threshold	20 Hz

Input signals

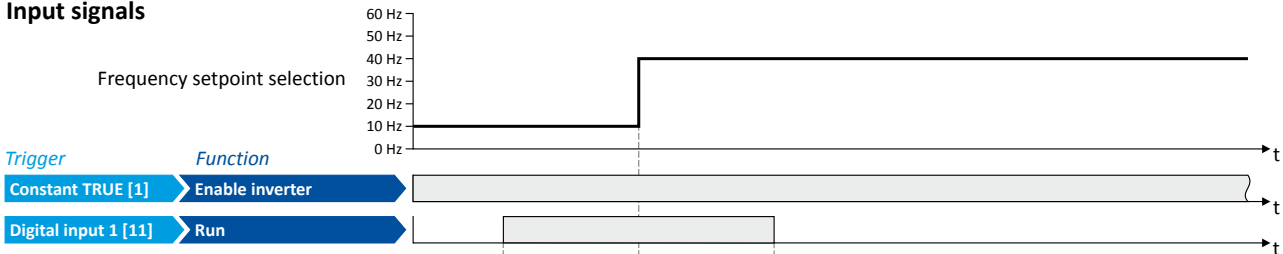

Output signals

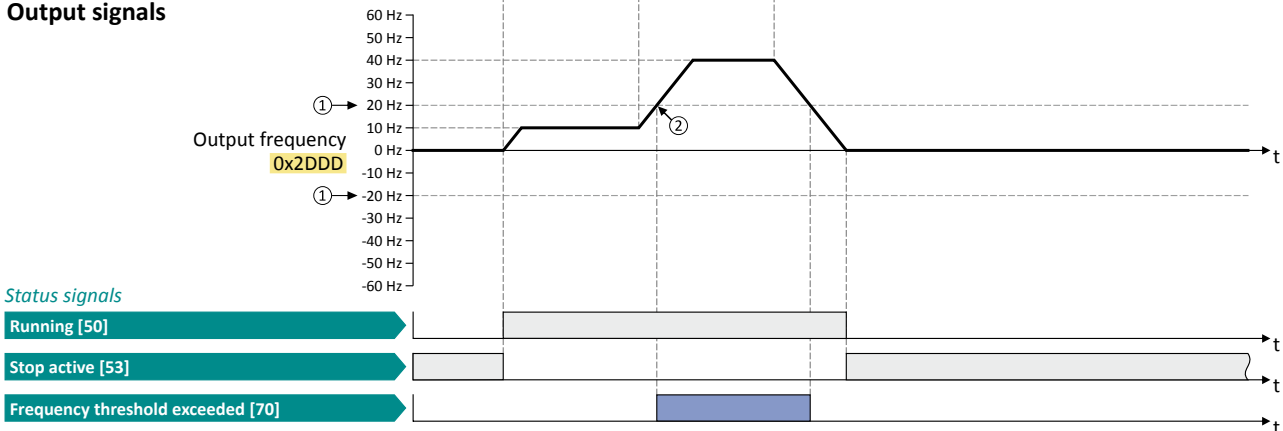

The status signals can be assigned to digital outputs. ▶ [Configuration of digital outputs](#) 574

- ① Frequency threshold 0x4005 (P412.00)
- ② Frequency threshold exceeded: Via trigger "Frequency threshold exceeded [70]", the digital output 1 is set to TRUE.



13.13 Configuration of digital inputs

Settings for digital inputs 1 ... 7.

Preconditions

Digital input 6 and digital input 7 are only available for a Control Unit (CU) with application I/O.

Details

The digital inputs are used for control tasks. For this purpose, the digital inputs are available as selectable triggers for functions.

The following settings are possible for the digital inputs:

- Assertion level "HIGH active" or "LOW active" ①
- Debounce time ②
- Inversion ③

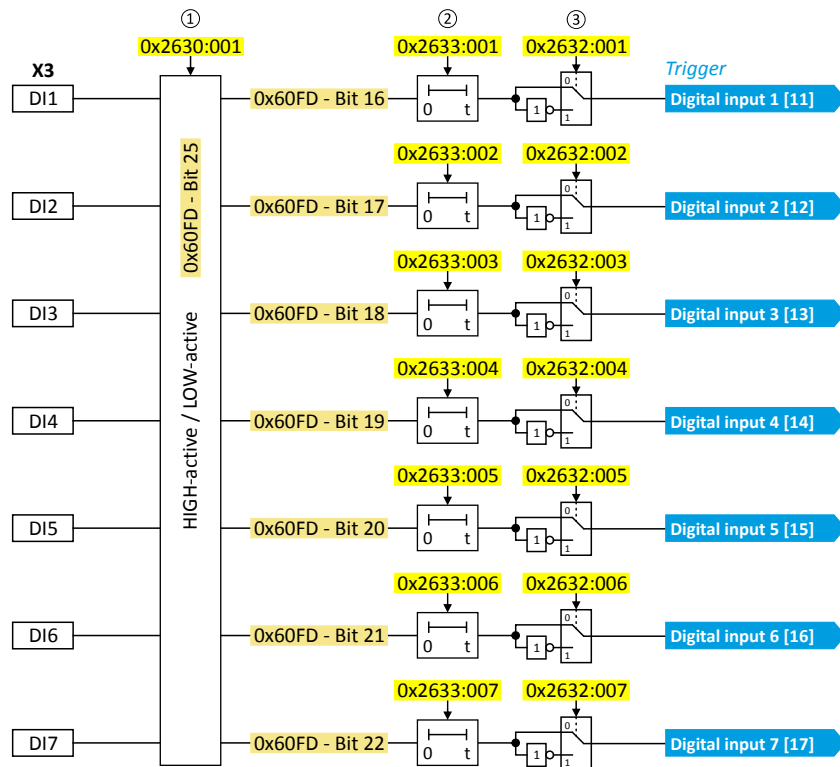

Diagnostic parameters:

- The logic status of the digital inputs is displayed in [0x60FD \(P118.00\)](#).

Flexible I/O configuration

Configuration of digital inputs



Assertion level "HIGH active" or "LOW active"

The digital inputs can be configured in 0x2630:001 (P410.01) HIGH active (default setting) or LOW active:

HIGH active (default setting)	LOW active
<ul style="list-style-type: none"> Internally, the digital input terminals are set to LOW level via pull-down resistors. The current flows from the current supply (e.g. X3/24V) through the contact to the digital input terminal (and internally via the pull-down resistor to GND). If the contact is closed, the digital input is set to HIGH level and is thus HIGH active. 	<ul style="list-style-type: none"> Internally, the digital input terminals are set to HIGH level via pull-up resistors. The current flows from the digital input terminal through the contact to GND. If the contact is closed, the digital input is set to LOW level and is thus LOW active.
<p>Connection plan (example):</p>	<p>Connection plan (example):</p>

Debounce time

For minimising interference pulses, a debounce time of 1 ms is set for all digital inputs.

Via »EASY Starter« (or network), the debounce time for can be increased individually for each digital input to maximally 50 ms.

Inversion

Each digital input can be configured in such a way that the status pending at the terminal is internally inverted logically. This way, a closed contact, for instance, serves to deactivate an assigned function instead of activating it. Thus, the control of the inverter can be flexibly adapted to the requirements of the actual application.

Parameter	Name / value range / [default setting]	Info
0x2630:001 (P410.01)	Settings for digital inputs: Assertion level (DI settings: Assertion level)	Definition of the internal hardware interconnection of the digital input terminal (X3/DIx).
	0 LOW active	Digital input terminals (X3/DIx) are set to HIGH level via pull-up resistors.
	1 HIGH active	Digital input terminals (X3/DIx) are set to LOW level via pull-down resistors.
0x2630:002 (P410.02)	Settings for digital inputs: Input function (DI settings: Input function)	Input function of the digital terminals DI3 and DI4.
	0 Digital input	DI3 = digital input DI4 = digital input
	1 HTL encoder (AB) (from version 02.00)	DI3 = HTL input for encoder track B DI4 = HTL input for encoder track A
	2 Pulse train (from version 03.00)	DI3 = digital input DI4 = HTL input for pulse train
	3 Pulse train/direction (from version 03.00)	DI3 = HTL input for direction specification; HIGH level = counter-clockwise (CCW) DI4 = HTL input for pulse train
0x2632:001 (P411.01)	Inversion of digital inputs: Digital input 1 (DI inversion: DI1 inversion)	Inversion of digital input 1
	0 Not inverted	
	1 Inverted	
0x2632:002 (P411.02)	Inversion of digital inputs: Digital input 2 (DI inversion: DI2 inversion)	Inversion of digital input 2
	0 Not inverted	
	1 Inverted	
0x2632:003 (P411.03)	Inversion of digital inputs: Digital input 3 (DI inversion: DI3 inversion)	Inversion of digital input 3
	0 Not inverted	
	1 Inverted	



Parameter	Name / value range / [default setting]	Info
0x2632:004 (P411.04)	Inversion of digital inputs: Digital input 4 (DI inversion: DI4 inversion)	Inversion of digital input 4
	0 Not inverted	
0x2632:005 (P411.05)	Inversion of digital inputs: Digital input 5 (DI inversion: DI5 inversion)	Inversion of digital input 5
	0 Not inverted	
0x2632:006 (P411.06)	Inversion of digital inputs: Digital input 6 (DI inversion: DI6 inversion) • Only available for application I/O.	Inversion of digital input 6
	0 Not inverted	
0x2632:007 (P411.07)	Inversion of digital inputs: Digital input 7 (DI inversion: DI7 inversion) • Only available for application I/O.	Inversion of digital input 7
	0 Not inverted	
0x2633:001	Digital input debounce time: Digital input 1 1 ... [1] ... 50 ms	Debounce time of digital input 1
0x2633:002	Digital input debounce time: Digital input 2 1 ... [1] ... 50 ms	Debounce time of digital input 2
0x2633:003	Digital input debounce time: Digital input 3 1 ... [1] ... 50 ms	Debounce time of digital input 3
0x2633:004	Digital input debounce time: Digital input 4 1 ... [1] ... 50 ms	Debounce time of digital input 4
0x2633:005	Digital input debounce time: Digital input 5 1 ... [1] ... 50 ms	Debounce time of digital input 5
0x2633:006	Digital input debounce time: Digital input 6 1 ... [1] ... 50 ms • Only available for application I/O.	Debounce time of digital input 6
0x2633:007	Digital input debounce time: Digital input 7 1 ... [1] ... 50 ms • Only available for application I/O.	Debounce time of digital input 7

Example: Activating two functions simultaneously via digital input 4

The principle of assigning triggers to functions also enables a digital input to be assigned to several functions. The wiring complexity is reduced since there is no necessity to interconnect several digital inputs.

If, for instance, the frequency preset 1 is to be selected via the digital input 4 and a change-over to the acceleration time 2 and deceleration time 2 is to take place at the same time, this can be easily realised by the following parameter setting:

Parameter	Name	Setting for this example
0x2631:018 (P400.18)	Activate preset (bit 0)	Digital input 4 [14]
0x2631:039 (P400.39)	Activate ramp 2	Digital input 4 [14]



In order to achieve the desired behaviour, the digital input 4 must not be assigned to any further functions!

Flexible I/O configuration

Configuration of analog inputs
Analog input 1



13.14 Configuration of analog inputs

13.14.1 Analog input 1

Settings for analog input 1.

Details

The analog input 1 can be used as setpoint source. ▶ [Selection of setpoint source](#) 122

For the process controller, the analog input can be used for the feedback of the variable (actual value) or speed feedforward control. ▶ [Basic process controller settings](#) 357

The following settings are possible for the analog input:

- Definition of the input range ①
- Filter time for low-pass filters ②
- Monitoring of the input signal ③
- Dead band for eliminating the smallest signal levels ④
- Definition of the setting range ⑤

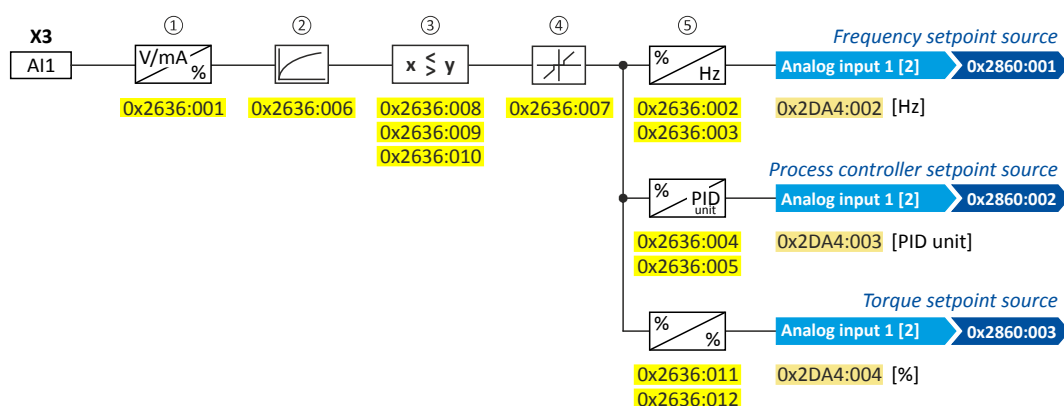

Diagnostic parameters:

- The frequency value is displayed in 0x2DA4:002 (P110.02).
- The process controller value is displayed in 0x2DA4:003 (P110.03).
- The torque value is displayed in 0x2DA4:004 (P110.04).

Definition of the input range

The analog input can be configured as voltage or current input. Internally, the signal is always converted to a value in percent.

Definition of the setting range

The setting range results from the set min and max value for the respective mode.

Configuration examples

Detailed configuration examples can be found in the following subchapters:

- ▶ [Example 1: Input range 0 ... 10 V ≡ setting range 0 ... 50 Hz](#) 570
- ▶ [Example 2: Input range 0 ... 10 V ≡ setting range -40 ... +40 Hz](#) 570
- ▶ [Example 3: Input range -10 ... +10 V ≡ setting range -40 ... +40 Hz](#) 571
- ▶ [Example 4: Error detection](#) 571

Parameter	Name / value range / [default setting]	Info
0x2636:001 (P430.01)	Analog input 1: Input range (Analog input 1: AI1 input range)	Definition of the input range.
	0 0 ... 10 VDC	
	1 0 ... 5 VDC	
	2 2 ... 10 VDC	
	3 -10 ... +10 VDC	
	4 4 ... 20 mA	
5 0 ... 20 mA		



Flexible I/O configuration

Configuration of analog inputs

Analog input 1

Parameter	Name / value range / [default setting]	Info				
0x2636:002 (P430.02)	Analog input 1: Min frequency value (Analog input 1: AI1 freq @ min) -1000.0 ... [0.0] ... 1000.0 Hz	Definition of the setting range for operating mode "MS: Velocity mode". <ul style="list-style-type: none"> Direction of rotation according to sign. The standard setpoint source for operating mode 0x6060 (P301.00) = "MS: Velocity mode [-2]" is selected in 0x2860:001 (P201.01). 				
0x2636:003 (P430.03)	Analog input 1: Max frequency value (Analog input 1: AI1 freq @ max) Device for 50-Hz mains: -1000.0 ... [50.0] ... 1000.0 Hz Device for 60-Hz mains: -1000.0 ... [60.0] ... 1000.0 Hz					
0x2636:004 (P430.04)	Analog input 1: Min PID value (Analog input 1: AI1 PID @ min) -300.00 ... [0.00] ... 300.00 PID unit	Definition of the setting range for PID control. <ul style="list-style-type: none"> The standard setpoint source for the reference value of PID control is selected in 0x2860:002 (P201.02). 				
0x2636:005 (P430.05)	Analog input 1: Max PID value (Analog input 1: AI1 PID @ max) -300.00 ... [100.00] ... 300.00 PID unit					
0x2636:006 (P430.06)	Analog input 1: Filter time (Analog input 1: AI1 filter time) 0 ... [10] ... 10000 ms	PT1 time constant for low-pass filter. <ul style="list-style-type: none"> By the use of a low-pass filter, the impacts of noise to an analog signal can be minimised. For an optimum filter effect, first the noise frequency has to be determined. The time constant then has to be set so that it equals the reciprocal value of the double frequency. 				
0x2636:007 (P430.07)	Analog input 1: Dead band (Analog input 1: AI1 dead band) 0.0 ... [0.0] ... 100.0 %	Optional setting of a dead band that is placed symmetrically around the frequency zero point. <ul style="list-style-type: none"> The value set defines half the width of the dead band in [%]. Example: Setting 2 % results in a dead band of 4 %. If the analog input value is within the dead band, the output value for the motor control is set to "0". 				
0x2636:008 (P430.08)	Analog input 1: Monitoring threshold (Analog input 1: AI1 monit.level) -100.0 ... [0.0] ... 100.0 %	Monitoring threshold for analog input 1. <ul style="list-style-type: none"> 100 % ≙ 10 V (with configuration as voltage input) 100 % ≙ 20 mA (with configuration as current loop) 				
0x2636:009 (P430.09)	Analog input 1: Monitoring condition (Analog input 1: AI1 monit.cond.) <table border="1" style="width: 100%; border-collapse: collapse;"> <tr> <td style="text-align: center;">0</td> <td>Input value < trigger threshold</td> </tr> <tr> <td style="text-align: center;">1</td> <td>Input value > trigger threshold</td> </tr> </table>	0	Input value < trigger threshold	1	Input value > trigger threshold	Monitoring condition for analog input 1. <ul style="list-style-type: none"> If the selected condition is met, the "Error of analog input 1 active [81]" trigger is set to TRUE. The trigger can be assigned to a function or a digital output. If the selected condition is met for at least 500 ms, the error response set in 0x2636:010 (P430.10) takes place.
0	Input value < trigger threshold					
1	Input value > trigger threshold					
0x2636:010 (P430.10)	Analog input 1: Error response (Analog input 1: AI1 error resp.) <ul style="list-style-type: none"> For further possible settings, see parameter 0x2D45:001 (P310.01). □ 196 <table border="1" style="width: 100%; border-collapse: collapse;"> <tr> <td style="text-align: center;">3</td> <td>Fault</td> </tr> </table>	3	Fault	Error response for analog input 1. <ul style="list-style-type: none"> The selected response takes place if the monitoring condition selected in 0x2636:009 (P430.09) is met for at least 500 ms. Associated error code: <ul style="list-style-type: none"> 28801 0x7081 - Analog input 1 fault ▶ Error types □ 113		
3	Fault					
0x2636:011 (P430.11)	Analog input 1: Min torque value (Analog input 1: Min. torque) -400.0 ... [0.0] ... 400.0 % <ul style="list-style-type: none"> From version 03.00 	Definition of the setting range for operating mode "MS: Torque mode". <ul style="list-style-type: none"> 100 % ≙ permissible maximum torque 0x6072 (P326.00) Direction of rotation according to sign. The standard setpoint source for operating mode 0x6060 (P301.00) = "MS: Torque mode [-1]" is selected in 0x2860:003 (P201.03). ▶ Torque control w/ freq. limit □ 179 				
0x2636:012 (P430.12)	Analog input 1: Max torque value (Analog input 1: Max. torque) -400.0 ... [100.0] ... 400.0 % <ul style="list-style-type: none"> From version 03.00 					

Flexible I/O configuration

Configuration of analog inputs
Analog input 1



13.14.1.1 Example 1: Input range 0 ... 10 V \equiv setting range 0 ... 50 Hz

In this configuration, for instance, a frequency setpoint between 0 and 50 Hz can be set with a potentiometer connected to the analog input.

Connection plan	function
	Potentiometer R1 Frequency setpoint selection (Input voltage 1 V \equiv 5 Hz)

Parameter	Name	Setting for this example
0x2636:001 (P430.01)	Analog input 1: Input range	0 ... 10 VDC [0]
0x2636:002 (P430.02)	Analog input 1: Min frequency value	0.0 Hz
0x2636:003 (P430.03)	Analog input 1: Max frequency value	50.0 Hz
0x2636:006 (P430.06)	Analog input 1: Filter time	10 ms

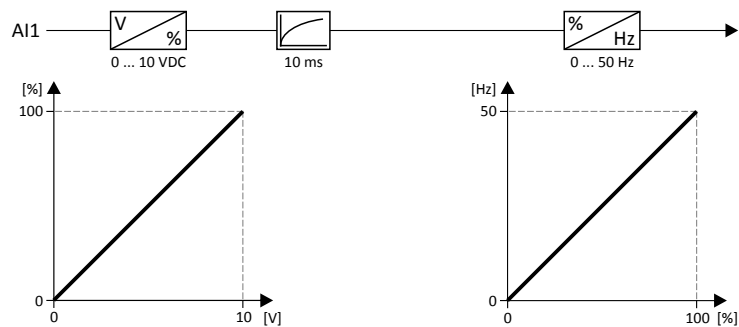

13.14.1.2 Example 2: Input range 0 ... 10 V \equiv setting range -40 ... +40 Hz

In this example, a bipolar setting range and a dead band with 2 % are configured.

Parameter	Name	Setting for this example
0x2636:001 (P430.01)	Analog input 1: Input range	0 ... 10 VDC [0]
0x2636:002 (P430.02)	Analog input 1: Min frequency value	-40.0 Hz
0x2636:003 (P430.03)	Analog input 1: Max frequency value	40.0 Hz
0x2636:006 (P430.06)	Analog input 1: Filter time	10 ms
0x2636:007 (P430.07)	Analog input 1: Dead band	2.0 %

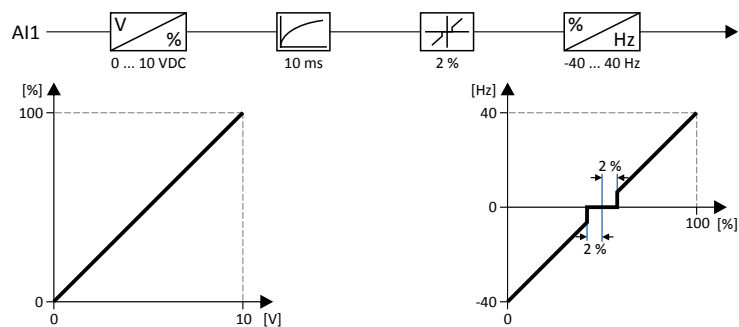



Flexible I/O configuration

Configuration of analog inputs

Analog input 1

13.14.1.3 Example 3: Input range -10 ... +10 V \equiv setting range -40 ... +40 Hz

In this example, the input range of the analog input is bipolar. For the setting range that is bipolar as well, a dead band with 2 % is configured.

Parameter	Name	Setting for this example
0x2636:001 (P430.01)	Analog input 1: Input range	-10 ... +10 VDC [3]
0x2636:002 (P430.02)	Analog input 1: Min frequency value	-40.0 Hz
0x2636:003 (P430.03)	Analog input 1: Max frequency value	40.0 Hz
0x2636:006 (P430.06)	Analog input 1: Filter time	10 ms
0x2636:007 (P430.07)	Analog input 1: Dead band	2.0 %

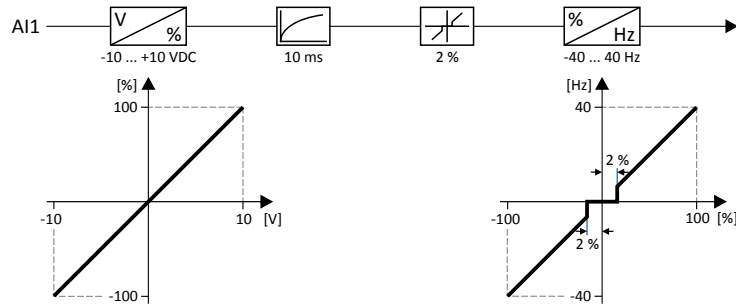

13.14.1.4 Example 4: Error detection

In this example, the digital output 1 is set via the trigger "Error of analog input 1 active [81]" if the percentage input value is lower than 10 %. Additionally, a warning is output.

Parameter	Name	Setting for this example
0x2634:002 (P420.02)	Digital outputs function: Digital output 1	Error of analog input 1 active [81]
0x2636:001 (P430.01)	Analog input 1: Input range	0 ... 10 VDC [0]
0x2636:002 (P430.02)	Analog input 1: Min frequency value	0.0 Hz
0x2636:003 (P430.03)	Analog input 1: Max frequency value	40.0 Hz
0x2636:006 (P430.06)	Analog input 1: Filter time	10 ms
0x2636:008 (P430.08)	Analog input 1: Monitoring threshold	10.0 %
0x2636:009 (P430.09)	Analog input 1: Monitoring condition	Input value < trigger threshold [0]
0x2636:010 (P430.10)	Analog input 1: Error response	Warning [1]

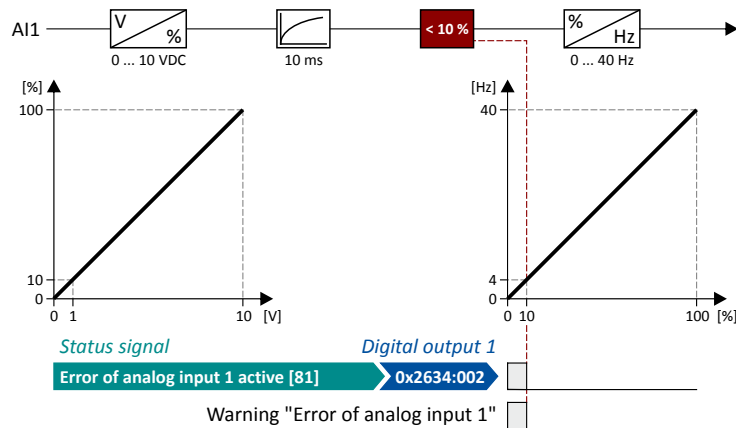

Flexible I/O configuration

Configuration of analog inputs
Analog input 2



13.14.2 Analog input 2

Settings for analog input 2.

Preconditions

Control Unit (CU) with application I/O

Details

The analog input 2 can be used as setpoint source. ▶ [Selection of setpoint source](#) 122

For the process controller, the analog input can be used for the feedback of the variable (actual value) or speed feedforward control. ▶ [Basic process controller settings](#) 357

The following settings are possible for the analog input:

- Definition of the input range ①
- Filter time for low-pass filters ②
- Monitoring of the input signal ③
- Dead band for eliminating the smallest signal levels ④
- Definition of the setting range ⑤

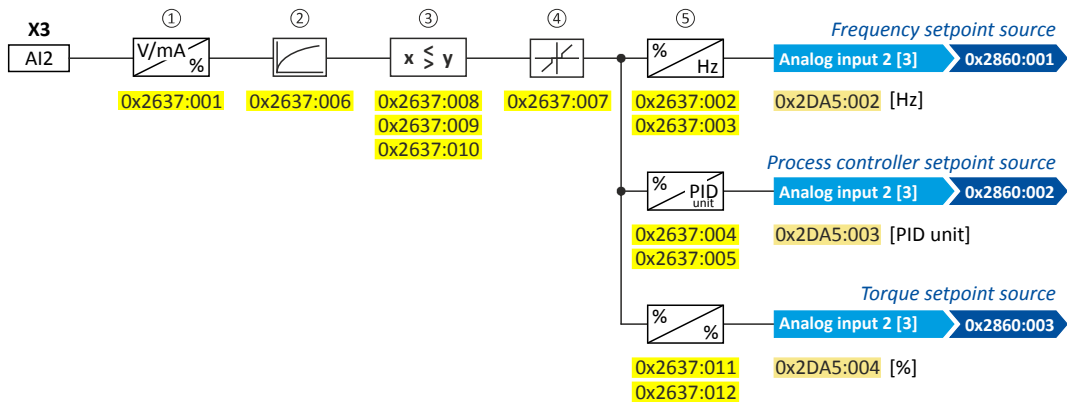

Diagnostic parameters:

- The frequency value is displayed in [0x2DA5:002 \(P111.02\)](#).
- The process controller value is displayed in [0x2DA5:003 \(P111.03\)](#).
- The torque value is displayed in [0x2DA5:004 \(P111.04\)](#).

For further details and configuration examples, see chapter "[Analog input 1](#)". 568

Parameter	Name / value range / [default setting]	Info
0x2637:001 (P431.01)	Analog input 2: Input range (Analog input 2: AI2 input range) 0 0 ... 10 VDC 1 0 ... 5 VDC 2 2 ... 10 VDC 3 -10 ... +10 VDC 4 4 ... 20 mA 5 0 ... 20 mA	Definition of the input range.
0x2637:002 (P431.02)	Analog input 2: Min frequency value (Analog input 2: AI2 freq @ min) -1000.0 ... [0.0] ... 1000.0 Hz	Definition of the setting range for operating mode "MS: Velocity mode". • Direction of rotation according to sign. • The standard setpoint source for operating mode 0x6060 (P301.00) = "MS: Velocity mode [-2]" is selected in 0x2860:001 (P201.01).
0x2637:003 (P431.03)	Analog input 2: Max frequency value (Analog input 2: AI2 freq @ max) Device for 50-Hz mains: -1000.0 ... [50.0] ... 1000.0 Hz Device for 60-Hz mains: -1000.0 ... [60.0] ... 1000.0 Hz	
0x2637:004 (P431.04)	Analog input 2: Min PID value (Analog input 2: AI2 PID @ min) -300.00 ... [0.00] ... 300.00 PID unit	Definition of the setting range for PID control. • The standard setpoint source for the reference value of PID control is selected in 0x2860:002 (P201.02).
0x2637:005 (P431.05)	Analog input 2: Max PID value (Analog input 2: AI2 PID @ max) -300.00 ... [100.00] ... 300.00 PID unit	



Flexible I/O configuration

Configuration of analog inputs

Analog input 2

Parameter	Name / value range / [default setting]	Info
0x2637:006 (P431.06)	Analog input 2: Filter time (Analog input 2: AI2 filter time) 0 ... [10] ... 10000 ms	PT1 time constant for low-pass filter. <ul style="list-style-type: none"> By the use of a low-pass filter, the impacts of noise to an analog signal can be minimised. For an optimum filter effect, first the noise frequency has to be determined. The time constant then has to be set so that it equals the reciprocal value of the double frequency.
0x2637:007 (P431.07)	Analog input 2: Dead band (Analog input 2: AI2 dead band) 0.0 ... [0.0] ... 100.0 %	Optional setting of a dead band that is placed symmetrically around the frequency zero point. <ul style="list-style-type: none"> The value set defines half the width of the dead band in [%]. Example: Setting 2 % results in a dead band of 4 %. If the analog input value is within the dead band, the output value for the motor control is set to "0".
0x2637:008 (P431.08)	Analog input 2: Monitoring threshold (Analog input 2: AI2 monit.level) -100.0 ... [0.0] ... 100.0 %	Monitoring threshold for analog input 2. Trigger threshold for monitoring the analog input. <ul style="list-style-type: none"> 100 % \equiv 10 V (with configuration as voltage input) 100 % \equiv 20 mA (with configuration as current loop)
0x2637:009 (P431.09)	Analog input 2: Monitoring condition (Analog input 2: AI2 error resp.)	Monitoring condition for analog input 2. Trigger condition for monitoring the analog input. <ul style="list-style-type: none"> If the selected condition is met, the "Error of analog input 2 active [82]" trigger is set to TRUE. The trigger can be assigned to a function or a digital output. If the selected condition is met for at least 500 ms, the error response set in 0x2637:010 (P431.10) takes place. If the trigger condition is met for at least 500 ms, the response set in subindex 10 is effected.
	0 Input value < trigger threshold	Monitoring condition for analog input 2. <ul style="list-style-type: none"> If the selected condition is met, the "Error of analog input 2 active [82]" trigger is set to TRUE. The trigger can be assigned to a function or a digital output. If the selected condition is met for at least 500 ms, the error response set in 0x2637:010 (P431.10) takes place.
0x2637:010 (P431.10)	Analog input 2: Error response (Analog input 2: AI2 error resp.) <ul style="list-style-type: none"> For further possible settings, see parameter 0x2D45:001 (P310.01). □ 196 	Error response for analog input 2. <ul style="list-style-type: none"> The selected response takes place if the monitoring condition selected in 0x2637:009 (P431.09) is met for at least 500 ms. Associated error code: <ul style="list-style-type: none"> 28802 0x7082 - Analog input 2 fault
	3 Fault	▶ Error types □ 113
0x2637:011 (P431.11)	Analog input 2: Min torque value (Analog input 2: Min. torque) -400.0 ... [0.0] ... 400.0 % <ul style="list-style-type: none"> From version 03.00 	Definition of the setting range for operating mode "MS: Torque mode". <ul style="list-style-type: none"> 100 % \equiv permissible maximum torque 0x6072 (P326.00) Direction of rotation according to sign. The standard setpoint source for operating mode 0x6060 (P301.00) = "MS: Torque mode [-1]" is selected in 0x2860:003 (P201.03).
0x2637:012 (P431.12)	Analog input 2: Max torque value (Analog input 2: Max. torque) -400.0 ... [100.0] ... 400.0 % <ul style="list-style-type: none"> From version 03.00 	▶ Torque control w/ freq. limit □ 179

Flexible I/O configuration

Configuration of digital outputs
Relay



13.15 Configuration of digital outputs

Parameter	Name / value range / [default setting]	Info
0x404D:003 (P608.03)	PID alarms: Monitoring bandwidth PID feedback signal (PID alarms: Bandw. feedback) 0.00 ... [2.00] ... 100.00 % • From version 04.00	Hysteresis for status signal "PID feedback = setpoint [73]". • 100 % ≙ configured variable input range • Example: Variable input range 0 ... 10 V: 2 % ≙ 0.2 V • The status signal "PID feedback = setpoint [73]" is TRUE if the controlled variable feedback = process controller setpoint (± hysteresis set here). • The status signal can be assigned to the relay, a digital output of the NetWordOUT1 status word. ▶ Configuration of digital outputs 573

13.15.1 Relay

Settings for the relay.



Relay is not suitable for direct switching of an electromechanical holding brake!

Use a corresponding suppressor circuit in case of an inductive or capacitive load!

Details

The relay is controlled with the trigger selected in [0x2634:001 \(P420.01\)](#).

The following settings are possible for the relay:

- Inversion ①
- Switch-on delay ②
- Cutout delay ③

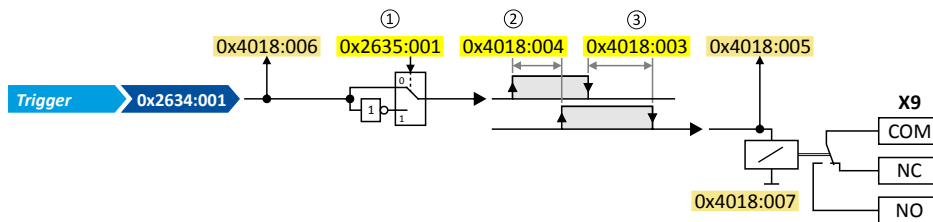

Diagnostic parameters:

- The logic status of the trigger signal is displayed in [0x4018:006](#).
- The logic status of the relay is displayed in [0x4018:005](#).
- The current switching cycles of the relay are shown in [0x4018:007](#).

Parameter	Name / value range / [default setting]	Info
0x2634:001 (P420.01)	Digital outputs function: Relay (Dig.out.function: Relay function)	Assignment of a trigger to the relay. Trigger = FALSE: X9/NO-COM open and NC-COM closed. Trigger = TRUE: X9/NO-COM closed and NC-COM open. Notes: • An inversion set in 0x2635:001 (P421.01) is taken into consideration here.
	0 Not connected	No trigger assigned (trigger is constantly FALSE).
	1 Constant TRUE	Trigger is constantly TRUE.
	11 Digital input 1	State of X3/DI1, taking an inversion set in 0x2632:001 (P411.01) into consideration.
	12 Digital input 2	State of X3/DI2, taking an inversion set in 0x2632:002 (P411.02) into consideration.
	13 Digital input 3	State of X3/DI3, taking an inversion set in 0x2632:003 (P411.03) into consideration.
	14 Digital input 4	State of X3/DI4, taking an inversion set in 0x2632:004 (P411.04) into consideration.
	15 Digital input 5	State of X3/DI5, taking an inversion set in 0x2632:005 (P411.05) into consideration.
	16 Digital input 6	State of X3/DI6, taking an inversion set in 0x2632:006 (P411.06) into consideration. Digital input 6 is only available in the Control Unit (CU) with application I/O.



Flexible I/O configuration

Configuration of digital outputs

Relay

Parameter	Name / value range / [default setting]	Info
	17 Digital input 7	State of X3/DI7, taking an inversion set in 0x2632:007 (P411.07) into consideration. Digital input 7 is only available in the Control Unit (CU) with application I/O.
	30 NetWordIN1 - bit 12	State of NetWordIN1/bit 12 ... 15. <ul style="list-style-type: none"> • Display of NetWordIN1 in 0x4008:001 (P590.01). • For implementing an individual control word format, NetWordIN1 can be mapped to a process data input word.
	31 NetWordIN1 - bit 13	
	32 NetWordIN1 - bit 14	
	33 NetWordIN1 - bit 15	
	34 NetWordIN2 - bit 0	
	35 NetWordIN2 - bit 1	State of NetWordIN2/bit 0 ... bit 15. <ul style="list-style-type: none"> • Display of NetWordIN2 in 0x4008:002 (P590.02). • For controlling the digital outputs via network, NetWordIN2 can be mapped to a process data input word.
	36 NetWordIN2 - bit 2	
	37 NetWordIN2 - bit 3	
	38 NetWordIN2 - bit 4	
	39 NetWordIN2 - bit 5	
	40 NetWordIN2 - bit 6	
	41 NetWordIN2 - bit 7	
	42 NetWordIN2 - bit 8	
	43 NetWordIN2 - bit 9	
	44 NetWordIN2 - bit 10	
	45 NetWordIN2 - bit 11	
	46 NetWordIN2 - bit 12	
	47 NetWordIN2 - bit 13	
	48 NetWordIN2 - bit 14	
	49 NetWordIN2 - bit 15	
	50 Running	TRUE if inverter and start are enabled and output frequency > 0.2 Hz. Otherwise FALSE.
	51 Ready for operation	TRUE if inverter is ready for operation (no error active, no STO active and DC-bus voltage ok). Otherwise FALSE.
	52 Operation enabled	TRUE if inverter and start are enabled. Otherwise FALSE.
	53 Stop active	TRUE if inverter is enabled and motor is not started and output frequency = 0.
	54 Quick stop active	TRUE if quick stop is active. Otherwise FALSE.
	55 Safe torque off (STO) active	TRUE if the integrated safety system has triggered the "Safe torque off (STO)" function. Otherwise FALSE. ▶ Safe torque off (STO) ¶ 492
	56 Error active	TRUE if error is active. Otherwise FALSE.
	57 Error (non-resettable) active	TRUE if non-resettable error is active. Otherwise FALSE.
	58 Device warning active	TRUE if warning is active. Otherwise FALSE. • A warning has no impact on the operating status of the inverter. • A warning is reset automatically if the cause has been eliminated.
	59 Device trouble active	TRUE if a fault is active. Otherwise FALSE. • In the event of a fault, the motor is brought to a standstill with the quick stop ramp. The inverter is then disabled. • Exception: In case of a serious fault, the inverter is disabled immediately. The motor becomes torqueless (coasts). • The error state will be left automatically if the error condition is not active anymore. • The restart behaviour after trouble can be configured. ▶ Automatic restart ¶ 441
	60 Heatsink temperature warning active	TRUE if current heatsink temperature > warning threshold for temperature monitoring. Otherwise FALSE. • Display of the current heatsink temperature in 0x2D84:001 (P117.01) . • Setting of the warning threshold in 0x2D84:002 .
	65 Motor PTC error active	TRUE if an error of the motor PTC has been detected. Otherwise FALSE. • The trigger is set irrespective of the response set in 0x2D49:002 (P309.02) when the motor temperature monitoring is triggered. ▶ Motor temperature monitoring ¶ 192
	66 Flying restart circuit active	TRUE if flying restart circuit active is active. Otherwise FALSE. ▶ Flying restart circuit ¶ 438

Flexible I/O configuration

Configuration of digital outputs

Relay



Parameter	Name / value range / [default setting]	Info
67	DC braking active	TRUE if DC braking is active. Otherwise FALSE. ▶ DC braking □ 386
69	Rotational direction reversed	TRUE if output frequency is negative. Otherwise FALSE.
70	Frequency threshold exceeded	TRUE if current output frequency > frequency threshold. Otherwise FALSE. • Display of the current output frequency in 0x2DDD (P100.00) . • Setting Frequency threshold in 0x4005 (P412.00) . ▶ Frequency threshold for "Frequency threshold exceeded" trigger □ 564
71	Actual speed = 0	TRUE if current output frequency = 0 Hz (± 0.01 Hz), irrespective of the operating mode. Otherwise FALSE. • Display of the current output frequency in 0x2DDD (P100.00) .
72	Setpoint speed reached	TRUE if frequency setpoint reached. Otherwise FALSE.
73	PID feedback = setpoint	TRUE if the controlled variable fed back = process controller setpoint (± in 0x404D:003 (P608.03) set hysteresis). Otherwise FALSE. ▶ Basic process controller settings □ 357
74	PID idle state active	TRUE if the inverter is in "PID idle state". Otherwise FALSE. ▶ Process controller idle state □ 363
75	PID MIN alarm active	TRUE if fed back variable (with activated PID control) < MIN alarm threshold. Otherwise FALSE. • Setting of MIN alarm threshold in 0x404D:001 (P608.01) . ▶ Basic process controller settings □ 357
76	PID MAX alarm active	TRUE if the fed back variable (with activated PID control) > MAX alarm threshold. Otherwise FALSE. • Setting of MAX alarm threshold in 0x404D:002 (P608.02) . ▶ Basic process controller settings □ 357
77	PID MIN-MAX alarm active	TRUE if no PID alarm is active with activated PID control (MIN alarm threshold < fed back variable < MAX alarm threshold). Otherwise FALSE. • Setting of MIN alarm threshold in 0x404D:001 (P608.01) . • Setting of MAX alarm threshold in 0x404D:002 (P608.02) . ▶ Basic process controller settings □ 357
78	Current limit reached	TRUE if current motor current ≥ maximum current. Otherwise FALSE. • Display of the present motor current in 0x2D88 (P104.00) . • Setting for the maximum current in 0x6073 (P324.00) .
79	Torque limit reached	TRUE if torque limit has been reached or exceeded. Otherwise FALSE. • Setting "Positive torque limit" in 0x60E0 . • Setting "Negative torque limit" in 0x60E1 .
81	Error of analog input 1 active	TRUE if the monitoring of the input signal at the analog input 1 has responded. Otherwise FALSE. This trigger is set as a function of the following settings: • Monitoring threshold 0x2636:008 (P430.08) • Monitoring condition 0x2636:009 (P430.09) The setting of the Error response in 0x2636:010 (P430.10) has no effect on this trigger. ▶ Analog input 1 □ 568
82	Error of analog input 2 active	TRUE if the monitoring of the input signal at the analog input 2 has responded. Otherwise FALSE. This trigger is set as a function of the following settings: • Monitoring threshold 0x2637:008 (P431.08) • Monitoring condition 0x2637:009 (P431.09) The setting of the Error response in 0x2637:010 (P431.10) has no effect on this trigger. ▶ Analog input 2 □ 572
83	Load loss detected	TRUE if actual motor current < threshold for load loss detection after delay time of the load loss detection has elapsed. Otherwise FALSE. • Display of the present motor current in 0x6078 (P103.00) . • Setting Threshold in 0x4006:001 (P710.01) . • Setting Deceleration in 0x4006:002 (P710.02) . ▶ Load loss detection □ 397
100	Sequencer controlled (from version 03.00)	The control is executed via the sequencer (according to the configuration of the digital outputs for the current segment). ▶ Segment configuration □ 464



Flexible I/O configuration

Configuration of digital outputs

Relay

Parameter	Name / value range / [default setting]	Info
	101 Sequence active (from version 03.00)	Status signal of the "sequencer" function: TRUE if the sequence is running and is currently not suspended. ▶ Sequencer □ 462
	102 Sequence suspended (from version 03.00)	Status signal of the "sequencer" function: TRUE if the sequence is currently suspended. ▶ Sequencer □ 462
	103 Sequence done (from version 03.00)	Status signal of the "sequencer" function: TRUE if the sequence is completed (final segment has been passed through). ▶ Sequencer □ 462
	104 Local control active	TRUE if local keypad control ("LOC") active. Otherwise FALSE.
	105 Remote control active	TRUE if remote control ("REM") via terminals, network, etc. active. Otherwise FALSE.
	106 Manual setpoint selection active	TRUE if manual setpoint selection ("MAN") via keypad active. Otherwise FALSE. • Selection of the trigger for the "Activate keypad setpoint" function in 0x2631:016 (P400.16) .
	107 Automatic setpoint selection active	TRUE if automatic setpoint selection ("AUTO") via terminals, network, etc. active. Otherwise FALSE.
	108 Parameter set 1 active	TRUE if parameter set 1 is loaded and active. Otherwise FALSE.
	109 Parameter set 2 active	TRUE if parameter set 2 is loaded and active. Otherwise FALSE.
	110 Parameter set 3 active	TRUE if parameter set 3 is loaded and active. Otherwise FALSE.
	111 Parameter set 4 active	TRUE if parameter set 4 is loaded and active. Otherwise FALSE.
	112 Parameter set load OK	TRUE after any parameter set has been loaded. Otherwise FALSE.
	113 Parameter set load fail	TRUE if any of the parameter sets could not be loaded. Otherwise FALSE.
	115 Release holding brake	Trigger signal for releasing the holding brake (TRUE = release holding brake). Note! If this trigger is assigned to the relay or a digital output, the deceleration times set for the respective output are not effective (are internally set to "0"). Only the deceleration time set in 0x2820:012 (P712.12) for closing the holding brake influences in this case the time-dependent behaviour of the output. ▶ Holding brake control □ 429
	117 Motor phase failure	TRUE if a motor phase failure has been detected. Otherwise FALSE. ▶ Motor phase failure detection □ 196
0x2635:001 (P421.01)	Inversion of digital outputs: Relay (DO inversion: Relay inverted) 0 Not inverted 1 Inverted	Relay inversion
0x4018:003	Relay: Switch-off delay 0.000 ... [0.000] ... 65.535 s	Switch-off delay for the relay. Note! The set delay time is not effective (internally set to "0") if the relay is assigned to the trigger "Release holding brake [115]". Only the deceleration time set in 0x2820:012 (P712.12) for closing the holding brake influences the time-dependent behaviour of the relay.
0x4018:004	Relay: Switch-on delay 0.000 ... [0.000] ... 65.535 s	Switch-on delay for the relay. Note! The set delay time is not effective (internally set to "0") if the relay is assigned to the trigger "Release holding brake [115]". Only the deceleration time set in 0x2820:012 (P712.12) for closing the holding brake influences the time-dependent behaviour of the relay.
0x4018:005	Relay: Relay state • Read only 0 FALSE 1 TRUE	Display of the logic state of the relay.
0x4018:006	Relay: Trigger signal state • Read only 0 FALSE 1 TRUE	Display of the logic state of the trigger signal for the relay (without taking a ON/OFF delay set and inversion into consideration).

Flexible I/O configuration

Configuration of digital outputs
Digital output 1



Parameter	Name / value range / [default setting]	Info
0x4018:007	Relay: Switching cycles • Read only	Display of the previous relay switching cycles.

13.15.2 Digital output 1

Settings for digital output 1.

Details

The digital output 1 is controlled with the trigger selected in [0x2634:002 \(P420.02\)](#).

The following settings are possible for the digital output:

- Inversion ①
- Switch-on delay ②
- Cutout delay ③

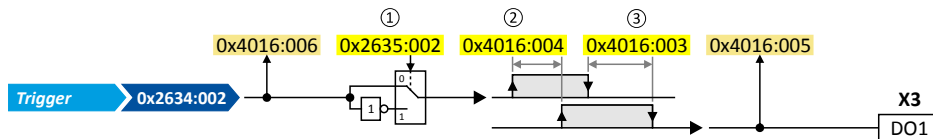

Diagnostic parameters:

- The logic status of the trigger signal is displayed in [0x4016:006](#).
- The logic status of the digital output is displayed in [0x4016:005](#).

Parameter	Name / value range / [default setting]	Info
0x2634:002 (P420.02)	Digital outputs function: Digital output 1 (Dig.out.function: DO1 function) • For further possible settings, see parameter 0x2634:001 (P420.01) . □ 574	Assignment of a trigger to digital output 1. Trigger = FALSE: X3/DO1 set to LOW level. Trigger = TRUE: X3/DO1 set to HIGH level. Notes: • An inversion set in 0x2635:002 (P421.02) is taken into consideration here.
	115 Release holding brake	Trigger signal for releasing the holding brake (TRUE = release holding brake). Note! If this trigger is assigned to the relay or a digital output, the deceleration times set for the respective output are not effective (are internally set to "0"). Only the deceleration time set in 0x2820:012 (P712.12) for closing the holding brake influences in this case the time-dependent behaviour of the output. ▶ Holding brake control □ 429
0x2635:002 (P421.02)	Inversion of digital outputs: Digital output 1 (DO inversion: DO1 inversion)	Inversion of digital output 1
	0 Not inverted 1 Inverted	
0x4016:003	Digital output 1: Cutout delay 0.000 ... [0.000] ... 65.535 s	Switch-off delay for digital output 1. Note! The set delay time is not effective (internally set to "0") if the relay is assigned to the trigger "Release holding brake [115]". Only the deceleration time set in 0x2820:012 (P712.12) for closing the holding brake influences the time-dependent behaviour of the digital output.
0x4016:004	Digital output 1: Switch-on delay 0.000 ... [0.000] ... 65.535 s	Switch-on delay for digital output 1. Note! The set delay time is not effective (internally set to "0") if the relay is assigned to the trigger "Release holding brake [115]". Only the deceleration time set in 0x2820:012 (P712.12) for closing the holding brake influences the time-dependent behaviour of the digital output.
0x4016:005	Digital output 1: Terminal state • Read only	Display of the logic state of output terminal X3/DO1.
	0 FALSE 1 TRUE	



Flexible I/O configuration

Configuration of digital outputs
Digital output 2

Parameter	Name / value range / [default setting]	Info
0x4016:006	Digital output 1: Trigger signal state • Read only	Display of the logic state of the trigger signal for digital output 1 (without taking a ON/OFF delay set and inversion into consideration).
	0 FALSE	
	1 TRUE	

13.15.3 Digital output 2

Settings for digital output 2.

Preconditions

Control Unit (CU) with application I/O

Details

The digital output 2 is controlled with the trigger selected in [0x2634:003 \(P420.03\)](#).

The following settings are possible for the digital output:

- Inversion ①
- Switch-on delay ②
- Cutout delay ③

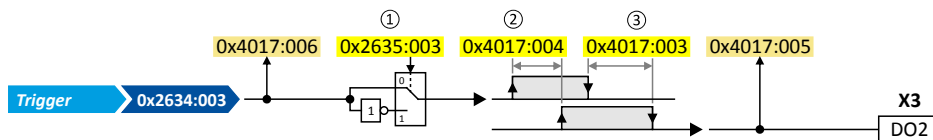

Diagnostic parameters:

- The logic status of the trigger signal is displayed in [0x4017:006](#).
- The logic status of the digital output is displayed in [0x4017:005](#).

Parameter	Name / value range / [default setting]	Info
0x2634:003 (P420.03)	Digital outputs function: Digital output 2 (Dig.out.function: DO2 function) • Only available for application I/O. • For further possible settings, see parameter 0x2634:001 (P420.01) . 574	Assignment of a trigger to digital output 2. Trigger = FALSE: X3/DO2 set to LOW level. Trigger = TRUE: X3/DO2 set to HIGH level. Notes: • An inversion set in 0x2635:003 (P421.03) is taken into consideration here.
	56 Error active	TRUE if error is active. Otherwise FALSE.
0x2635:003 (P421.03)	Inversion of digital outputs: Digital output 2 (DO inversion: DO2 inversion) • Only available for application I/O.	Inversion of digital output 2
	0 Not inverted	
	1 Inverted	
0x4017:003	Digital output 2: Cutout delay 0.000 ... [0.000] ... 65.535 s • Only available for application I/O.	Switch-off delay for digital output 2. Note! The set delay time is not effective (internally set to "0") if the relay is assigned to the trigger "Release holding brake [115]". Only the deceleration time set in 0x2820:012 (P712.12) for closing the holding brake influences the time-dependent behaviour of the digital output.
0x4017:004	Digital output 2: Switch-on delay 0.000 ... [0.000] ... 65.535 s • Only available for application I/O.	Switch-on delay for digital output 2. Note! The set delay time is not effective (internally set to "0") if the relay is assigned to the trigger "Release holding brake [115]". Only the deceleration time set in 0x2820:012 (P712.12) for closing the holding brake influences the time-dependent behaviour of the digital output.
0x4017:005	Digital output 2: Terminal state • Read only • Only available for application I/O.	Display of the logic state of output terminal X3/DO2.
	0 FALSE	
	1 TRUE	

Flexible I/O configuration

Configuration of digital outputs
NetWordOUT1 status word

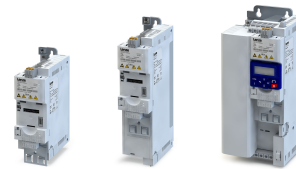

Parameter	Name / value range / [default setting]	Info
0x4017:006	Digital output 2: Trigger signal state	Display of the logic state of the trigger signal for digital output 2 (without taking a ON/OFF delay set and inversion into consideration).
	• Read only	
	• Only available for application I/O.	
	0 FALSE	
	1 TRUE	

13.15.4 NetWordOUT1 status word

Assignment of digital triggers to bit 0 ... bit 15 of the NetWordOUT1 status word.

Details

The following table shows the preset status assignment of the NetWordOUT1 data word:

Bit	Default setting	For details and configuration, see
0	Ready for operation	0x2634:010 (P420.10)
1	Not connected	0x2634:011 (P420.11)
2	Operation enabled	0x2634:012 (P420.12)
3	Error active	0x2634:013 (P420.13)
4	Not connected	0x2634:014 (P420.14)
5	Quick stop active	0x2634:015 (P420.15)
6	Running	0x2634:016 (P420.16)
7	Device warning active	0x2634:017 (P420.17)
8	Not connected	0x2634:018 (P420.18)
9	Not connected	0x2634:019 (P420.19)
10	Setpoint speed reached	0x2634:020 (P420.20)
11	Current limit reached	0x2634:021 (P420.21)
12	Actual speed = 0	0x2634:022 (P420.22)
13	Rotational direction reversed	0x2634:023 (P420.23)
14	Release holding brake	0x2634:024 (P420.24)
15	Safe torque off (STO) active	0x2634:025 (P420.25)

The following parameters can be used to change the status assignment of the NetWordOUT1 data word.

Parameter	Name / value range / [default setting]	Info
0x2634:010 (P420.10)	Digital outputs function: NetWordOUT1 - bit 0 (Dig.out.function: NetWordOUT1.00)	Assignment of a trigger to bit 0 of NetWordOUT1. Trigger = FALSE: bit set to 0. Trigger = TRUE: bit set to 1.
	• For further possible settings, see parameter 0x2634:001 (P420.01) . □ 574	
	51 Ready for operation	TRUE if inverter is ready for operation (no error active, no STO active and DC-bus voltage ok). Otherwise FALSE.
0x2634:011 (P420.11)	Digital outputs function: NetWordOUT1 - bit 1 (Dig.out.function: NetWordOUT1.01)	Assignment of a trigger to bit 1 of NetWordOUT1. Trigger = FALSE: bit set to 0. Trigger = TRUE: bit set to 1.
	• For further possible settings, see parameter 0x2634:001 (P420.01) . □ 574	
	0 Not connected	No trigger assigned (trigger is constantly FALSE).
0x2634:012 (P420.12)	Digital outputs function: NetWordOUT1 - bit 2 (Dig.out.function: NetWordOUT1.02)	Assignment of a trigger to bit 2 of NetWordOUT1. Trigger = FALSE: bit set to 0. Trigger = TRUE: bit set to 1.
	• For further possible settings, see parameter 0x2634:001 (P420.01) . □ 574	
	52 Operation enabled	TRUE if inverter and start are enabled. Otherwise FALSE.
0x2634:013 (P420.13)	Digital outputs function: NetWordOUT1 - bit 3 (Dig.out.function: NetWordOUT1.03)	Assignment of a trigger to bit 3 of NetWordOUT1. Trigger = FALSE: bit set to 0. Trigger = TRUE: bit set to 1.
	• For further possible settings, see parameter 0x2634:001 (P420.01) . □ 574	
	56 Error active	TRUE if error is active. Otherwise FALSE.
0x2634:014 (P420.14)	Digital outputs function: NetWordOUT1 - bit 4 (Dig.out.function: NetWordOUT1.04)	Assignment of a trigger to bit 4 of NetWordOUT1. Trigger = FALSE: bit set to 0. Trigger = TRUE: bit set to 1.
	• For further possible settings, see parameter 0x2634:001 (P420.01) . □ 574	
	0 Not connected	No trigger assigned (trigger is constantly FALSE).



Flexible I/O configuration

Configuration of digital outputs
NetWordOUT1 status word

Parameter	Name / value range / [default setting]	Info
0x2634:015 (P420.15)	Digital outputs function: NetWordOUT1 - bit 5 (Dig.out.function: NetWordOUT1.05) • For further possible settings, see parameter 0x2634:001 (P420.01) . 574	Assignment of a trigger to bit 5 of NetWordOUT1. Trigger = FALSE: bit set to 0. Trigger = TRUE: bit set to 1.
	54 Quick stop active	TRUE if quick stop is active. Otherwise FALSE.
0x2634:016 (P420.16)	Digital outputs function: NetWordOUT1 - bit 6 (Dig.out.function: NetWordOUT1.06) • For further possible settings, see parameter 0x2634:001 (P420.01) . 574	Assignment of a trigger to bit 6 of NetWordOUT1. Trigger = FALSE: bit set to 0. Trigger = TRUE: bit set to 1.
	50 Running	TRUE if inverter and start are enabled and output frequency > 0.2 Hz. Otherwise FALSE.
0x2634:017 (P420.17)	Digital outputs function: NetWordOUT1 - bit 7 (Dig.out.function: NetWordOUT1.07) • For further possible settings, see parameter 0x2634:001 (P420.01) . 574	Assignment of a trigger to bit 7 of NetWordOUT1. Trigger = FALSE: bit set to 0. Trigger = TRUE: bit set to 1.
	58 Device warning active	TRUE if warning is active. Otherwise FALSE. • A warning has no impact on the operating status of the inverter. • A warning is reset automatically if the cause has been eliminated.
0x2634:018 (P420.18)	Digital outputs function: NetWordOUT1 - bit 8 (Dig.out.function: NetWordOUT1.08) • For further possible settings, see parameter 0x2634:001 (P420.01) . 574	Assignment of a trigger to bit 8 of NetWordOUT1. Trigger = FALSE: bit set to 0. Trigger = TRUE: bit set to 1.
	0 Not connected	No trigger assigned (trigger is constantly FALSE).
0x2634:019 (P420.19)	Digital outputs function: NetWordOUT1 - bit 9 (Dig.out.function: NetWordOUT1.09) • For further possible settings, see parameter 0x2634:001 (P420.01) . 574	Assignment of a trigger to bit 9 of NetWordOUT1. Trigger = FALSE: bit set to 0. Trigger = TRUE: bit set to 1.
	0 Not connected	No trigger assigned (trigger is constantly FALSE).
0x2634:020 (P420.20)	Digital outputs function: NetWordOUT1 - bit 10 (Dig.out.function: NetWordOUT1.10) • For further possible settings, see parameter 0x2634:001 (P420.01) . 574	Assignment of a trigger to bit 10 of NetWordOUT1. Trigger = FALSE: bit set to 0. Trigger = TRUE: bit set to 1.
	72 Setpoint speed reached	TRUE if frequency setpoint reached. Otherwise FALSE.
0x2634:021 (P420.21)	Digital outputs function: NetWordOUT1 - bit 11 (Dig.out.function: NetWordOUT1.11) • For further possible settings, see parameter 0x2634:001 (P420.01) . 574	Assignment of a trigger to bit 11 of NetWordOUT1. Trigger = FALSE: bit set to 0. Trigger = TRUE: bit set to 1.
	78 Current limit reached	TRUE if current motor current \geq maximum current. Otherwise FALSE. • Display of the present motor current in 0x2D88 (P104.00) . • Setting for the maximum current in 0x6073 (P324.00) .
0x2634:022 (P420.22)	Digital outputs function: NetWordOUT1 - bit 12 (Dig.out.function: NetWordOUT1.12) • For further possible settings, see parameter 0x2634:001 (P420.01) . 574	Assignment of a trigger to bit 12 of NetWordOUT1. Trigger = FALSE: bit set to 0. Trigger = TRUE: bit set to 1.
	71 Actual speed = 0	TRUE if current output frequency = 0 Hz (\pm 0.01 Hz), irrespective of the operating mode. Otherwise FALSE. • Display of the current output frequency in 0x2DDD (P100.00) .
0x2634:023 (P420.23)	Digital outputs function: NetWordOUT1 - bit 13 (Dig.out.function: NetWordOUT1.13) • For further possible settings, see parameter 0x2634:001 (P420.01) . 574	Assignment of a trigger to bit 13 of NetWordOUT1. Trigger = FALSE: bit set to 0. Trigger = TRUE: bit set to 1.
	69 Rotational direction reversed	TRUE if output frequency is negative. Otherwise FALSE.

Flexible I/O configuration

Configuration of digital outputs
NetWordOUT1 status word



Parameter	Name / value range / [default setting]	Info
0x2634:024 (P420.24)	Digital outputs function: NetWordOUT1 - bit 14 (Dig.out.function: NetWordOUT1.14) • For further possible settings, see parameter 0x2634:001 (P420.01) . □ 574	Assignment of a trigger to bit 14 of NetWordOUT1. Trigger = FALSE: bit set to 0. Trigger = TRUE: bit set to 1.
	115 Release holding brake	Trigger signal for releasing the holding brake (TRUE = release holding brake). Note! If this trigger is assigned to the relay or a digital output, the deceleration times set for the respective output are not effective (are internally set to "0"). Only the deceleration time set in 0x2820:012 (P712.12) for closing the holding brake influences in this case the time-dependent behaviour of the output. ▶ Holding brake control □ 429
0x2634:025 (P420.25)	Digital outputs function: NetWordOUT1 - bit 15 (Dig.out.function: NetWordOUT1.15) • For further possible settings, see parameter 0x2634:001 (P420.01) . □ 574	Assignment of a trigger to bit 15 of NetWordOUT1. Trigger = FALSE: bit set to 0. Trigger = TRUE: bit set to 1.
	55 Safe torque off (STO) active	TRUE if the integrated safety system has triggered the "Safe torque off (STO)" function. Otherwise FALSE. ▶ Safe torque off (STO) □ 492
0x2635:010	Inversion of digital outputs: NetWordOUT1.00	Inversion of bit 0 of NetWordOUT1.
	0 Not inverted	
	1 Inverted	
0x2635:011	Inversion of digital outputs: NetWordOUT1.01	Inversion of bit 1 of NetWordOUT1.
	0 Not inverted	
	1 Inverted	
0x2635:012	Inversion of digital outputs: NetWordOUT1.02	Inversion of bit 2 of NetWordOUT1.
	0 Not inverted	
	1 Inverted	
0x2635:013	Inversion of digital outputs: NetWordOUT1.03	Inversion of bit 3 of NetWordOUT1.
	0 Not inverted	
	1 Inverted	
0x2635:014	Inversion of digital outputs: NetWordOUT1.04	Inversion of bit 4 of NetWordOUT1.
	0 Not inverted	
	1 Inverted	
0x2635:015	Inversion of digital outputs: NetWordOUT1.05	Inversion of bit 5 of NetWordOUT1.
	0 Not inverted	
	1 Inverted	
0x2635:016	Inversion of digital outputs: NetWordOUT1.06	Inversion of bit 6 of NetWordOUT1.
	0 Not inverted	
	1 Inverted	
0x2635:017	Inversion of digital outputs: NetWordOUT1.07	Inversion of bit 7 of NetWordOUT1.
	0 Not inverted	
	1 Inverted	
0x2635:018	Inversion of digital outputs: NetWordOUT1.08	Inversion of bit 8 of NetWordOUT1.
	0 Not inverted	
	1 Inverted	
0x2635:019	Inversion of digital outputs: NetWordOUT1.09	Inversion of bit 9 of NetWordOUT1.
	0 Not inverted	
	1 Inverted	
0x2635:020	Inversion of digital outputs: NetWordOUT1.10	Inversion of bit 10 of NetWordOUT1.
	0 Not inverted	
	1 Inverted	
0x2635:021	Inversion of digital outputs: NetWordOUT1.11	Inversion of bit 11 of NetWordOUT1.
	0 Not inverted	
	1 Inverted	



Flexible I/O configuration

Configuration of digital outputs
NetWordOUT1 status word

Parameter	Name / value range / [default setting]	Info
0x2635:022	Inversion of digital outputs: NetWordOUT1.12	Inversion of bit 12 of NetWordOUT1.
	0 Not inverted	
	1 Inverted	
0x2635:023	Inversion of digital outputs: NetWordOUT1.13	Inversion of bit 13 of NetWordOUT1.
	0 Not inverted	
	1 Inverted	
0x2635:024	Inversion of digital outputs: NetWordOUT1.14	Inversion of bit 14 of NetWordOUT1.
	0 Not inverted	
	1 Inverted	
0x2635:025	Inversion of digital outputs: NetWordOUT1.15	Inversion of bit 15 of NetWordOUT1.
	0 Not inverted	
	1 Inverted	

Flexible I/O configuration

Configuration of analog outputs
Analog output 1



13.16 Configuration of analog outputs

13.16.1 Analog output 1

Settings for analog input 1.

Details

The analog output 1 is controlled with the signal selected in [0x2639:002 \(P440.02\)](#).

The following settings are possible for the analog output:

- Definition of the signal range ①
- Definition of the output range ②

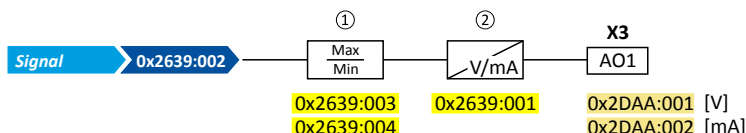

Diagnostic parameters:

- The current output voltage is displayed in [0x2DAA:001 \(P112.01\)](#).
- The actual output current is displayed in [0x2DAA:002 \(P112.02\)](#).

Definition of the signal range

The signal range results from the resolution of the selected signal multiplied by the set min and max signal value. Signals outside the signal range are cut off. For examples, see the following table:

Signal 0x2639:002 (P440.02)	Resolution	Min. signal 0x2639:003 (P440.03)	Max. signal 0x2639:004 (P440.04)	Signal range
Output frequency	0.1 Hz	0	1000	0 ... 100.0 Hz
Frequency setpoint	0.1 Hz	0	1000	0 ... 100.0 Hz
Analog input 1	0.1 %	0	1000	0 ... 100.0 %
Analog input 2	0.1 %	0	1000	0 ... 100.0 %
Motor current	0.1 A	0	100	0 ... 10.0 A
Output power	0.001 kW	0	250	0 ... 0.250 kW
Torque actual value	0.1 % *	0	1000	0 ... 100.0 % *
NetWordIN3	0.1 %	200	500	20.0 ... 50.0 %
NetWordIN4	0.1 %	0	250	0 ... 25.0 %

* 100 % ≡ Motor rated torque [0x6076 \(P325.00\)](#)

Detailed configuration examples can be found in the following subchapters.

Definition of the output range

The analog output can be configured as voltage or current source. The output range selected in [0x2639:001 \(P440.01\)](#) then corresponds to the configured signal range.

Configuration examples

Detailed configuration examples can be found in the following subchapters:

- ▶ [Example 1: Output voltage 0 ... 10 V ≡ output frequency 0 ... 100 Hz](#) [585](#)
- ▶ [Example 2: Output voltage 2 ... 10 V ≡ output frequency 30 ... 60 Hz](#) [586](#)

Parameter	Name / value range / [default setting]	Info
0x2639:001 (P440.01)	Analog output 1: Output range (Analog output 1: AO1 outp. range)	Definition of the output range.
	0 Inhibited	
	1 0 ... 10 VDC	
	2 0 ... 5 VDC	
	3 2 ... 10 VDC	
	4 4 ... 20 mA	
5 0 ... 20 mA		



Flexible I/O configuration

Configuration of analog outputs
Analog output 1

Parameter	Name / value range / [default setting]	Info
0x2639:002 (P440.02)	Analog output 1: Function (Analog output 1: AO1 function)	Selection of the signal to be shown at analog output 1.
	0 Not active	No output signal.
	1 Output frequency	Actual output frequency (resolution: 0.1 Hz).
	2 Frequency setpoint	Actual frequency setpoint (resolution: 0.1 Hz).
	3 Analog input 1	Input signal of analog input 1 (resolution: 0.1 %).
	4 Analog input 2	Input signal of analog input 2 (resolution: 0.1 %).
	5 Motor current	Actual motor current (resolution: 0.1 A).
	6 Output power	Actual output power (resolution: 0.001 kW).
	7 Torque actual value (from version 03.00)	Torque actual value (resolution: 0.1 %). • 100 % \equiv permissible maximum torque 0x6072 (P326.00)
	10 Sequencer controlled (from version 03.00)	Voltage value which has been set for the currently executed sequencer segment (resolution: 0.01 V). ▶ Sequencer 462
20 NetWordIN3	Actual value of the NetWordIN3 data word (resolution: 0.1 %). ▶ Further process data 226	
21 NetWordIN4	Actual value of the NetWordIN4 data word (resolution: 0.1 %). ▶ Further process data 226	
0x2639:003 (P440.03)	Analog output 1: Min. signal (Analog output 1: AO1 min. signal) -2147483648 ... [0] ... 2147483647	Definition of the signal value that corresponds to the minimum value at analog output 1. Example: configuration of analog output 1 as a 4 ... 20 mA current loop: output current 4 mA \equiv 0x2639:003
0x2639:004 (P440.04)	Analog output 1: Max. signal (Analog output 1: AO1 max. signal) -2147483648 ... [1000] ... 2147483647	Definition of the signal value that corresponds to the maximum value at analog output 1. Example: configuration of analog output 1 as a 4 ... 20 mA current loop: output current 20 mA \equiv 0x2639:004
0x4008:003 (P590.03)	Process input words: NetWordIN3 (NetWordINx: NetWordIN3) 0.0 ... [0.0] ... 100.0 %	Mappable data word for optional control of an analog output via network. Assignment of the analog outputs: • Analog output 1: 0x2639:002 (P440.02) = "NetWordIN3 [20]" • Analog output 2: 0x263A:002 (P441.02) = "NetWordIN3 [20]"
0x4008:004 (P590.04)	Process input words: NetWordIN4 (NetWordINx: NetWordIN4) 0.0 ... [0.0] ... 100.0 %	Mappable data word for optional control of an analog output via network. Assignment of the analog outputs: • Analog output 1: 0x2639:002 (P440.02) = "NetWordIN4 [21]" • Analog output 2: 0x263A:002 (P441.02) = "NetWordIN4 [21]"

13.16.1.1 Example 1: Output voltage 0 ... 10 V \equiv output frequency 0 ... 100 Hz

In this configuration, a voltage is provided at the analog output proportionately to the current output frequency of the inverter (1 V \equiv 10 Hz, resolution 0.1 Hz).

Parameter	Name	Setting for this example
0x2639:001 (P440.01)	Analog output 1: Output range	0 ... 10 VDC [1]
0x2639:002 (P440.02)	Analog output 1: Function	Output frequency [1]
0x2639:003 (P440.03)	Analog output 1: Min. signal	0
0x2639:004 (P440.04)	Analog output 1: Max. signal	1000

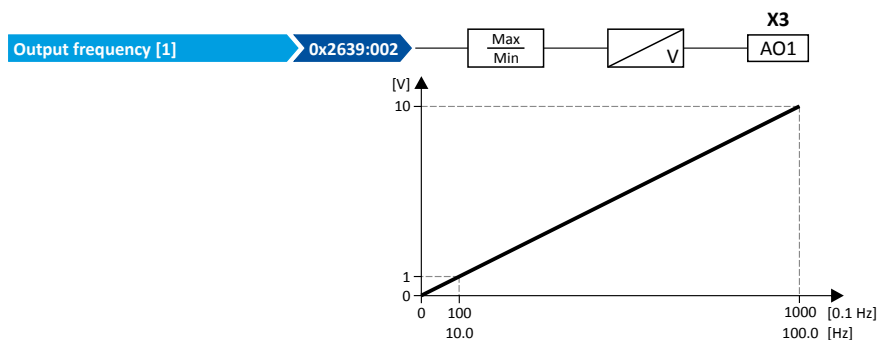

Flexible I/O configuration

Configuration of analog outputs
Analog output 2



13.16.1.2 Example 2: Output voltage 2 ... 10 V ≡ output frequency 30 ... 60 Hz

In this configuration, the output range 2 ... 10 V is used for the output of the output frequency (resolution: 0.1 Hz). The example shows how the signals outside the signal range (here: 30 ... 60 Hz) are cut off.

Parameter	Name	Setting for this example
0x2639:001 (P440.01)	Analog output 1: Output range	2 ... 10 VDC [3]
0x2639:002 (P440.02)	Analog output 1: Function	Output frequency [1]
0x2639:003 (P440.03)	Analog output 1: Min. signal	300
0x2639:004 (P440.04)	Analog output 1: Max. signal	600

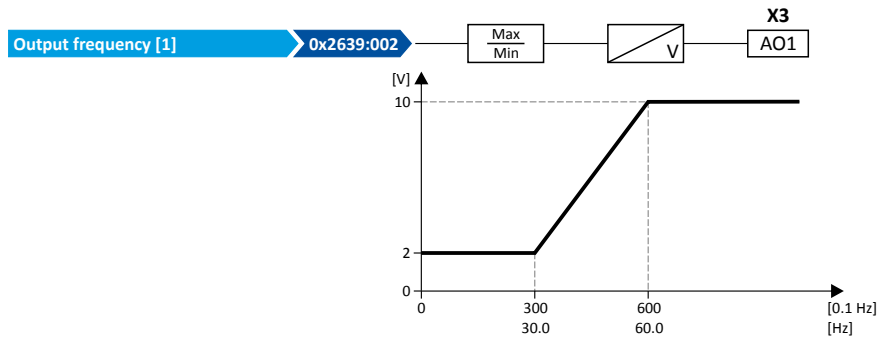

13.16.2 Analog output 2

Settings for analog input 2.

Preconditions

Control Unit (CU) with application I/O

Details

The analog output 2 is controlled with the signal selected in 0x263A:002 (P441.02).

The following settings are possible for the analog output:

- Definition of the signal range ①
- Definition of the output range ②

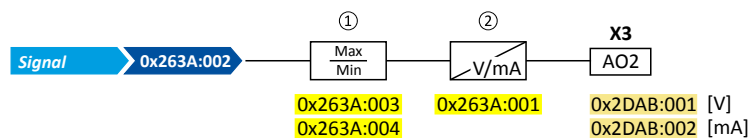

Diagnostic parameters:

- The current output voltage is displayed in 0x2DAB:002 (P113.02).
- The actual output current is displayed in 0x2DAB:001 (P113.01).

For further details and configuration examples, see chapter "Analog output 1". [584](#)

Parameter	Name / value range / [default setting]	Info
0x263A:001 (P441.01)	Analog output 2: Output range (Analog output 2: AO2 outp. range)	Definition of the output range.
	• Only available for application I/O.	
	0 Inhibited	
	1 0 ... 10 VDC	
	2 0 ... 5 VDC	
	3 2 ... 10 VDC	
4 4 ... 20 mA		
5 0 ... 20 mA		



Flexible I/O configuration

Configuration of analog outputs

Analog output 2

Parameter	Name / value range / [default setting]	Info
0x263A:002 (P441.02)	Analog output 2: Function (Analog output 2: AO2 function) • Only available for application I/O.	Selection of the signal to be shown at analog output 2.
	0 Not active	No output signal.
	1 Output frequency	Actual output frequency (resolution: 0.1 Hz).
	2 Frequency setpoint	Actual frequency setpoint (resolution: 0.1 Hz).
	3 Analog input 1	Input signal of analog input 1 (resolution: 0.1 %).
	4 Analog input 2	Input signal of analog input 2 (resolution: 0.1 %).
	5 Motor current	Actual motor current (resolution: 0.1 A).
	6 Output power	Actual output power (resolution: 0.001 kW).
	7 Torque actual value	Torque actual value (resolution: 0.1 %). • 100 % ≙ permissible maximum torque 0x6072 (P326.00)
	10 Sequencer controlled (from version 03.00)	Voltage value which has been set for the currently executed sequencer segment (resolution: 0.01 V). ▶ Sequencer 462
20 NetWordIN3	Actual value of the NetWordIN3 data word (resolution: 0.1 %). ▶ Further process data 226	
21 NetWordIN4	Actual value of the NetWordIN4 data word (resolution: 0.1 %). ▶ Further process data 226	
0x263A:003 (P441.03)	Analog output 2: Min. signal (Analog output 2: AO2 min. signal) -2147483648 ... [0] ... 2147483647 • Only available for application I/O.	Definition of the signal value that corresponds to the minimum value at analog output 2. Example: configuration of analog output 1 as a 4 ... 20 mA current loop: output current 4 mA ≙ 0x263A:003
0x263A:004 (P441.04)	Analog output 2: Max. signal (Analog output 2: AO2 max. signal) -2147483648 ... [1000] ... 2147483647 • Only available for application I/O.	Definition of the signal value that corresponds to the maximum value at analog output 2. Example: configuration of analog output 1 as a 4 ... 20 mA current loop: output current 20 mA ≙ 0x263A:004
0x4008:003 (P590.03)	Process input words: NetWordIN3 (NetWordINx: NetWordIN3) 0.0 ... [0.0] ... 100.0 %	Mappable data word for optional control of an analog output via network. Assignment of the analog outputs: • Analog output 1: 0x2639:002 (P440.02) = "NetWordIN3 [20]" • Analog output 2: 0x263A:002 (P441.02) = "NetWordIN3 [20]"
0x4008:004 (P590.04)	Process input words: NetWordIN4 (NetWordINx: NetWordIN4) 0.0 ... [0.0] ... 100.0 %	Mappable data word for optional control of an analog output via network. Assignment of the analog outputs: • Analog output 1: 0x2639:002 (P440.02) = "NetWordIN4 [21]" • Analog output 2: 0x263A:002 (P441.02) = "NetWordIN4 [21]"

Technical data

Standards and operating conditions
Conformities/approvals



14 Technical data

14.1 Standards and operating conditions

14.1.1 Conformities/approvals

Conformity		
CE	2014/35/EU	Low-Voltage Directive
	2014/30/EU	EMC Directive (reference: CE-typical drive system)
EAC	TR TC 004/2011	Eurasian conformity: safety of low voltage equipment
	TP TC 020/2011	Eurasian conformity: electromagnetic compatibility of technical means
RoHS 2	2011/65/EU	Restrictions for the use of specific hazardous materials in electric and electronic devices
Approval		
UL	UL 61800-5-1	for USA and Canada (requirements of the CSA 22.2 No. 274) File No. E???

14.1.2 Protection of persons and device protection

Degree of protection		
IP20	EN 60529	
Type 1	NEMA 250	Protection against contact
Open type		only in UL-approved systems
Insulation resistance		
Overvoltage category III	EN 61800-5-1	0 ... 2000 m a.m.s.l.
Overvoltage category II		above 2000 m a.m.s.l.
Control circuit isolation		
Safe mains isolation by double/reinforced insulation	EN 61800-5-1	
Protective measures against		
Short circuit		Earth fault strength depends on the operating status
earth fault		
overvoltage		
Motor stalling		PTC or thermal contact, I ² xt monitoring
Motor overtemperature		
Leakage current		
> 3.5 mA AC, > 10 mA DC	EN 61800-5-1	Observe regulations and safety instructions!
Starting current		
≤ 3 x rated mains current		

14.1.3 EMC data

Actuation on public supply systems		
Implement measures to limit the radio interference to be expected:		The machine or plant manufacturer is responsible for compliance with the requirements for the machine/plant!
< 1 kW: with mains choke	EN 61000-3-2	
> 1 kW at mains current ≤ 16 A: without additional measures		
Mains current > 16 A: with mains choke or mains filter, with dimensioning for rated power. R _{sce} ≥ 120 is to be met.	EN 61000-3-12	RSCE: short-circuit power ratio at the connection point of the machine/plant to the public network.
Noise emission		
Category C1	EN 61800-3	Type-dependent, for motor cable lengths see rated data
Category C2		
Noise immunity		
Meets requirement in compliance with	EN 61800-3	



14.1.4 Motor connection

Requirements to the shielded motor cable		
Capacitance per unit length		
C-core-core/C-core-shield < 75/150 pF/m		≤ 2.5 mm ² / AWG 14
C-core-core/C-core-shield < 150/300 pF/m		≥ 4 mm ² / AWG 12
Electric strength		
U ₀ /U = 0.6/1.0 kV		U ₀ = r.m.s. value external conductor to PE
U ≥ 600 V	UL	U = r.m.s. value external conductor/external conductor

14.1.5 Environmental conditions

Energy efficiency		
Class IE2	EN 50598-2	Reference: Lenze setting (switching frequency 8 kHz variable)
Climate		
1K3 (-25 ... +60 °C)	EN 60721-3-1	Storage
2K3 (-25 ... +70 °C)	EN 60721-3-2	Transport
3K3 (-10 ... +55 °C)	EN 60721-3-3	operation
		Operation at a switching frequency of 2 or 4 kHz: above +45°C, reduce rated output current by 2.5 %/°C
		Operation at a switching frequency of 8 or 16 kHz: above +40°C, reduce rated output current by 2.5 %/°C
Site altitude		
0 ... 1000 m a.m.s.l.		
1000 ... 4000 m a.m.s.l.		Reduce rated output current by 5 %/1000 m
Pollution		
Degree of pollution 2	EN 61800-5-1	
Vibration resistance		
Transport		
2M2 (sine, shock)	EN 60721-3-2	
operation		
Amplitude 1 mm	Germanischer Lloyd	5 ... 13.2 Hz
Amplitude 0.075 mm	EN 61800-5-1	10 ... 57 Hz

14.1.6 Electrical supply conditions

Permissible mains systems		
TT		Voltage to earth/ground: max. 300 V
TN		
IT		Apply the measures described for IT systems!
		IT systems are not relevant for UL-approved systems

Technical data

1-phase mains connection 230/240 V
Rated data



14.2 1-phase mains connection 230/240 V

14.2.1 Rated data

The output currents apply to these operating conditions:

- At a switching frequency of 2 kHz or 4 kHz: Max. ambient temperature 45°C.
- At a switching frequency of 8 kHz or 16 kHz: Max. ambient temperature 40 °C.

Inverter		I55AE125B	I55AE137B	I55AE155B	I55AE175B	I55AE211B	I55AE215B	I55AE222B
Rated power	kW	0.25	0.37	0.55	0.75	1.1	1.5	2.2
Mains voltage range		1/N/PE AC 170 V ... 264 V, 45 Hz ... 65 Hz						
Rated mains current								
without mains choke	A	4	5.7	7.6	10	14.3	16.7	22.5
with mains choke	A	3.6	4.8	7.1	8.8	11.9	13.9	16.9
Apparent output power	kVA	0.6	0.9	1.2	1.6	2.2	2.6	3.6
Output current								
2 kHz	A	-	-	3.2	4.2	6	7	9.6
4 kHz	A	1.7	2.4	3.2	4.2	6	7	9.6
8 kHz	A	1.7	2.4	3.2	4.2	6	7	9.6
16 kHz	A	1.1	1.6	2.1	2.8	4	4.7	6.4
Power loss								
4 kHz	W	15	18	23	29	37	43	60
8 kHz	W	15	20	25	33	42	50	70
at controller inhibit	W	6	6	6	6	6	6	6
Overcurrent cycle 180 s								
Max. output current	A	2.6	3.6	4.8	6.3	9	10.5	14.4
Overload time	s	60	60	60	60	60	60	60
Recovery time	s	120	120	120	120	120	120	120
Max. output current during the recovery time	A	1.3	1.8	2.4	3.2	4.5	5.3	7.2
Overcurrent cycle 15 s								
Max. output current	A	3.4	4.8	6.4	8.4	12	14	19.2
Overload time	s	3	3	3	3	3	3	3
Recovery time	s	12	12	12	12	12	12	12
Max. output current during the recovery time	A	1.3	1.8	2.4	3.2	4.5	5.3	7.2
Cyclic mains switching		3 times per minute						
Brake chopper								
Max. output current	A	2.2	2.2	3.9	3.9	12	12	12
Min. brake resistance	Ω	180	180	100	100	33	33	33
Max. motor cable length shielded								
without EMC category	m	50						
Category C1 (2 kHz, 4 kHz, 8 kHz)	m	3						
Category C2	m	15			20			
Weight	kg	0.8		1		1.35		

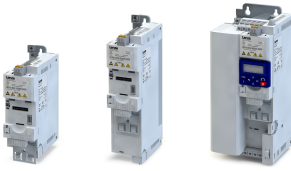

14.3 1/3-phase mains connection 230/240 V



I5xAExxD inverters do not have an integrated EMC filter in the AC mains supply.

In order to comply with the EMC requirements according to EN 61800–3, an external EMC filter according to IEC EN 60939 has to be used.

The user must prove that the EN 61800–3 requirements for conformity are fulfilled.

14.3.1 Rated data

The output currents apply to these operating conditions:

- At a switching frequency of 2 kHz or 4 kHz: Max. ambient temperature 45°C.
- At a switching frequency of 8 kHz or 16 kHz: Max. ambient temperature 40 °C.

Inverter		I55AE125D	I55AE137D	I55AE155D	I55AE175D	I55AE211D	I55AE215D	I55AE222D
Rated power	kW	0.25	0.37	0.55	0.75	1.1	1.5	2.2
Mains voltage range		1/N/PE AC 170 V ... 264 V, 45 Hz ... 65 Hz						
Rated mains current								
without mains choke	A	4	5.7	7.6	10	14.3	16.7	22.5
with mains choke	A	3.6	4.8	7.1	8.8	11.9	13.9	16.9
Mains voltage range		3/PE AC 170 V ... 264 V, 45 Hz ... 65 Hz						
Rated mains current								
without mains choke	A	2.6	3.9	4.8	6.4	7.8	9.5	13.6
with mains choke	A	2	3	3.8	5.1	5.6	6.8	9.8
Apparent output power	kVA	0.6	0.9	1.2	1.6	2.2	2.6	3.6
Output current								
2 kHz	A	-	-	3.2	4.2	6	7	9.6
4 kHz	A	1.7	2.4	3.2	4.2	6	7	9.6
8 kHz	A	1.7	2.4	3.2	4.2	6	7	9.6
16 kHz	A	1.1	1.6	2.1	2.8	4	4.7	6.4
Power loss								
4 kHz	W	15	18	23	29	37	43	60
8 kHz	W	15	20	25	33	42	50	70
at controller inhibit	W	6	6	6	6	6	6	6
Overcurrent cycle 180 s								
Max. output current	A	2.6	3.6	4.8	6.3	9	10.5	14.4
Overload time	s	60	60	60	60	60	60	60
Recovery time	s	120	120	120	120	120	120	120
Max. output current during the recovery time	A	1.3	1.8	2.4	3.2	4.5	5.3	7.2
Overcurrent cycle 15 s								
Max. output current	A	3.4	4.8	6.4	8.4	12	14	19.2
Overload time	s	3	3	3	3	3	3	3
Recovery time	s	12	12	12	12	12	12	12
Max. output current during the recovery time	A	1.3	1.8	2.4	3.2	4.5	5.3	7.2
Cyclic mains switching		3 times per minute						
Brake chopper								
Max. output current	A	2.2	2.2	3.9	3.9	12	12	12
Min. brake resistance	Ω	180	180	100	100	33	33	33
Max. motor cable length shielded								
without EMC category	m	50						
Weight	kg	0.8		1		1.35		

Technical data

3-phase mains connection 230/240 V

Rated data

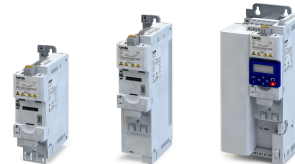

14.4 3-phase mains connection 230/240 V



I5xAExxD inverters do not have an integrated EMC filter in the AC mains supply.

In order to comply with the EMC requirements according to EN 61800–3, an external EMC filter according to IEC EN 60939 has to be used.

The user must prove that the EN 61800–3 requirements for conformity are fulfilled.

14.4.1 Rated data

The output currents apply to these operating conditions:

- At a switching frequency of 2 kHz or 4 kHz: Max. ambient temperature 45°C.
- At a switching frequency of 8 kHz or 16 kHz: Max. ambient temperature 40 °C.

Inverter		I55AE240C	I55AE255C
Rated power	kW	4	5.5
Mains voltage range		3/PE AC 170 V ... 264 V, 45 Hz ... 65 Hz	
Rated mains current			
without mains choke	A	20.6	28.8
with mains choke	A	15.7	21.9
Apparent output power	kVA	6.4	8.7
Output current			
2 kHz	A	16.5	23
4 kHz	A	16.5	23
8 kHz	A	16.5	23
16 kHz	A	11	15.3
Power loss			
4 kHz	W	115	175
8 kHz	W	130	195
at controller inhibit	W	6	6
Overcurrent cycle 180 s			
Max. output current	A	24.8	34.5
Overload time	s	60	60
Recovery time	s	120	120
Max. output current during the recovery time	A	12.4	17.3
Overcurrent cycle 15 s			
Max. output current	A	33	46
Overload time	s	3	3
Recovery time	s	12	12
Max. output current during the recovery time	A	12.4	17.3
Cyclic mains switching		3 times per minute	
Brake chopper			
Max. output current	A	26	26
Min. brake resistance	Ω	15	15
Max. motor cable length shielded			
without EMC category	m	50	
Weight	kg	2.1	



14.5 3-phase mains connection 400 V

14.5.1 Rated data

The output currents apply to these operating conditions:

- At a switching frequency of 2 kHz or 4 kHz: Max. ambient temperature 45°C.
- At a switching frequency of 8 kHz or 16 kHz: Max. ambient temperature 40 °C.

Inverter		I55AE137F	I55AE155F	I55AE175F	I55AE211F	I55AE215F	I55AE222F	I55AE230F
Rated power	kW	0.37	0.55	0.75	1.1	1.5	2.2	3
Mains voltage range		3/PE AC 340 V ... 528 V, 45 Hz ... 65 Hz						
Rated mains current								
without mains choke	A	1.8	2.5	3.3	4.4	5.4	7.8	9.6
with mains choke	A	1.4	2	2.6	3	3.7	5.3	6.9
Apparent output power	kVA	0.9	1.2	1.6	2.2	2.6	3.6	4.9
Output current								
2 kHz	A	-	1.8	2.4	3.2	3.9	5.6	7.3
4 kHz	A	1.3	1.8	2.4	3.2	3.9	5.6	7.3
8 kHz	A	1.3	1.8	2.4	3.2	3.9	5.6	7.3
16 kHz	A	0.9	1.2	1.6	2.1	2.6	3.7	4.9
Power loss								
4 kHz	W	20	25	32	40	48	66	85
8 kHz	W	24	31	40	51	61	85	110
at controller inhibit	W	6	6	6	6	6	6	6
Overcurrent cycle 180 s								
Max. output current	A	2	2.7	3.6	4.8	5.9	8.4	11
Overload time	s	60	60	60	60	60	60	60
Recovery time	s	120	120	120	120	120	120	120
Max. output current during the recovery time	A	1	1.4	1.8	2.4	2.9	4.2	5.5
Overcurrent cycle 15 s								
Max. output current	A	2.6	3.6	4.8	6.4	7.8	11.2	14.6
Overload time	s	3	3	3	3	3	3	3
Recovery time	s	12	12	12	12	12	12	12
Max. output current during the recovery time	A	1	1.4	1.8	2.4	2.9	4.2	5.5
Cyclic mains switching		3 times per minute						
Brake chopper								
Max. output current	A	2	2	2	4.3	4.3	4.3	9.5
Min. brake resistance	Ω	390	390	390	180	180	150	82
Max. motor cable length shielded								
without EMC category	m	15	-	-	50	-	-	50
Category C1 (2 kHz, 4 kHz, 8 kHz)	m	3			-			
Category C2	m	15	20					
Weight	kg	0.8	1		1.35		2.3	

Technical data

3-phase mains connection 400 V

Rated data



Inverter		I55AE240F	I55AE255F	I55AE275F	I55AE311F	I55AE315F	I55AE318F	I55AE322F
Rated power	kW	4	5.5	7.5	11	15	18.5	22
Mains voltage range		3/PE AC 340 V ... 528 V, 45 Hz ... 65 Hz						
Rated mains current								
without mains choke	A	12.5	17.2	20	28.4	38.7	48.4	-
with mains choke	A	9	12.4	15.7	22.3	28.8	36	42
Apparent output power	kVA	6.4	8.7	11	16	22	27	32
Output current								
2 kHz	A	9.5	13	16.5	23.5	32	40	47
4 kHz	A	9.5	13	16.5	23.5	32	40	47
8 kHz	A	9.5	13	16.5	23.5	32	40	47
16 kHz	A	6.3	8.7	11	15.7	21.3	26.6	31.3
Power loss								
4 kHz	W	110	145	185	260	360	450	520
8 kHz	W	140	190	240	340	460	570	670
at controller inhibit	W	6	6	6	6	18	18	18
Overcurrent cycle 180 s								
Max. output current	A	14.3	19.5	24.8	35	48	60	71
Overload time	s	60	60	60	60	60	60	60
Recovery time	s	120	120	120	120	120	120	120
Max. output current during the recovery time	A	7.1	9.8	12.4	17.6	24	30	35
Overcurrent cycle 15 s								
Max. output current	A	19	26	33	47	64	80	94
Overload time	s	3	3	3	3	3	3	3
Recovery time	s	12	12	12	12	12	12	12
Max. output current during the recovery time	A	7.1	9.8	12.4	17.6	24	30	35
Cyclic mains switching		3 times per minute						
Brake chopper								
Max. output current	A	16.6	16.6	29	29	43	52	52
Min. brake resistance	Ω	47	47	27	27	18	15	15
Max. motor cable length shielded								
without EMC category	m	-	50	100				-
Category C1 (2 kHz, 4 kHz, 8 kHz)	m	-						
Category C2	m	20						
Weight	kg	2.3		3.7		10.3		



Technical data

3-phase mains connection 400 V
Rated data

Inverter		I55AE330F	I55AE337F	I55AE345F	I55AE355F	I55AE375F
Rated power	kW	30	37	45	55	75
Mains voltage range		3/PE AC 340 V ... 528 V, 45 Hz ... 65 Hz				
Rated mains current						
without mains choke	A	-	-	-	-	-
with mains choke	A	54.9	68	80	99	135
Apparent output power	kVA	41	51	60	75	100
Output current						
2 kHz	A	61	76	89	110	150
4 kHz	A	61	76	89	110	150
8 kHz	A	61	76	89	110	150
16 kHz	A	40.7	50.7	59.4	73.4	100
Power loss						
4 kHz	W	680	840	980	1210	1640
8 kHz	W	880	1100	1280	1580	2140
at controller inhibit	W	25	25	25	30	30
Overcurrent cycle 180 s						
Max. output current	A	92	114	134	165	225
Overload time	s	60	60	60	60	60
Recovery time	s	120	120	120	120	120
Max. output current during the recovery time	A	46	57	67	83	113
Overcurrent cycle 15 s						
Max. output current	A	122	152	178	220	300
Overload time	s	3	3	3	3	3
Recovery time	s	12	12	12	12	12
Max. output current during the recovery time	A	46	57	67	83	113
Cyclic mains switching		3 times per minute			1 time per minute	
Brake chopper						
Max. output current	A	98	98	98	166	166
Min. brake resistance	Ω	7.5	7.5	7.5	4.7	4.7
Max. motor cable length shielded						
without EMC category	m	-	100	-		
Category C1 (2 kHz, 4 kHz, 8 kHz)	m	-				
Category C2	m	20				
Weight	kg	17.2			24	

Technical data

3-phase mains connection 480 V

Rated data



14.6 3-phase mains connection 480 V

14.6.1 Rated data

The output currents apply to these operating conditions:

- At a switching frequency of 2 kHz or 4 kHz: Max. ambient temperature 45°C.
- At a switching frequency of 8 kHz or 16 kHz: Max. ambient temperature 40 °C.

Inverter		I55AE137F	I55AE155F	I55AE175F	I55AE211F	I55AE215F	I55AE222F	I55AE230F
Rated power	kW	0.37	0.55	0.75	1.1	1.5	2.2	3
Mains voltage range		3/PE AC 340 V ... 528 V, 45 Hz ... 65 Hz						
Rated mains current								
without mains choke	A	1.5	2.1	2.8	3.7	4.5	6.5	8
with mains choke	A	1.2	1.7	2.2	2.5	3.1	4.4	5.8
Apparent output power	kVA	0.9	1.2	1.6	2.2	2.6	3.6	4.9
Output current								
2 kHz	A	-	1.6	2.1	3	3.5	4.8	6.3
4 kHz	A	1.1	1.6	2.1	3	3.5	4.8	6.3
8 kHz	A	1.1	1.6	2.1	3	3.5	4.8	6.3
16 kHz	A	0.7	1.1	1.4	2	2.3	3.2	4.2
Power loss								
4 kHz	W	20	25	32	40	48	66	85
8 kHz	W	24	31	40	51	61	85	110
at controller inhibit	W	6	6	6	6	6	6	6
Overcurrent cycle 180 s								
Max. output current	A	1.7	2.4	3.2	4.5	5.3	7.2	9.5
Overload time	s	60	60	60	60	60	60	60
Recovery time	s	120	120	120	120	120	120	120
Max. output current during the recovery time	A	0.8	1.2	1.6	2.3	2.6	3.6	4.8
Overcurrent cycle 15 s								
Max. output current	A	2.2	3.2	4.2	6	7	9.6	12.6
Overload time	s	3	3	3	3	3	3	3
Recovery time	s	12	12	12	12	12	12	12
Max. output current during the recovery time	A	0.8	1.2	1.6	2.3	2.6	3.6	4.7
Cyclic mains switching		3 times per minute						
Brake chopper								
Max. output current	A	2	2	2	4.3	4.3	4.3	9.5
Min. brake resistance	Ω	390	390	390	180	180	150	82
Max. motor cable length shielded								
without EMC category	m	15	-	-	50	-	-	50
Category C1 (2 kHz, 4 kHz, 8 kHz)	m	3			-			
Category C2	m	15	20					
Weight	kg	0.8	1		1.35			2.3



Technical data

3-phase mains connection 480 V
Rated data

Inverter		I55AE240F	I55AE255F	I55AE275F	I55AE311F	I55AE315F	I55AE318F	I55AE322F
Rated power	kW	4	5.5	7.5	11	15	18.5	22
Mains voltage range		3/PE AC 340 V ... 528 V, 45 Hz ... 65 Hz						
Rated mains current								
without mains choke	A	10.5	14.3	16.6	23.7	32.3	40.3	47.4
with mains choke	A	7.5	10.3	13.1	18.6	24	30	35.3
Apparent output power	kVA	6.4	8.7	11	16	22	27	32
Output current								
2 kHz	A	8.2	11	14	21	27	34	40.4
4 kHz	A	8.2	11	14	21	27	34	40.4
8 kHz	A	8.2	11	14	21	27	34	40.4
16 kHz	A	5.5	7.3	9.3	14	18	22.6	26.9
Power loss								
4 kHz	W	110	145	185	260	360	450	520
8 kHz	W	140	190	240	340	460	570	670
at controller inhibit	W	6	6	6	6	18	18	18
Overcurrent cycle 180 s								
Max. output current	A	12.3	16.5	21	31.5	40.5	51	61
Overload time	s	60	60	60	60	60	60	60
Recovery time	s	120	120	120	120	120	120	120
Max. output current during the recovery time	A	6.2	8.3	10.5	15.8	20.3	25.5	30
Overcurrent cycle 15 s								
Max. output current	A	16.4	22	28	42	54	68	81
Overload time	s	3	3	3	3	3	3	3
Recovery time	s	12	12	12	12	12	12	12
Max. output current during the recovery time	A	6.2	8.3	10.5	15.8	20.3	25.5	30
Cyclic mains switching		3 times per minute						
Brake chopper								
Max. output current	A	16.6	16.6	29	29	43	52	52
Min. brake resistance	Ω	47	47	27	27	18	15	15
Max. motor cable length shielded								
without EMC category	m	-	50	100				-
Category C1 (2 kHz, 4 kHz, 8 kHz)	m	-						
Category C2	m	20						
Weight	kg	2.3		3.7		10.3		

Technical data

3-phase mains connection 480 V

Rated data

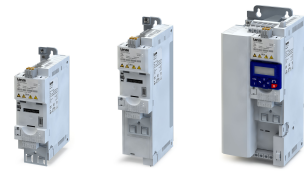

Inverter		I55AE330F	I55AE337F	I55AE345F	I55AE355F	I55AE375F
Rated power	kW	30	37	45	55	75
Mains voltage range		3/PE AC 340 V ... 528 V, 45 Hz ... 65 Hz				
Rated mains current						
without mains choke	A	-	-	-	-	-
with mains choke	A	45.7	57	66.7	83	113
Apparent output power	kVA	41	51	60	75	100
Output current						
2 kHz	A	52	65	77	96	124
4 kHz	A	52	65	77	96	124
8 kHz	A	52	65	77	96	124
16 kHz	A	34.7	43.4	51.4	64	82.7
Power loss						
4 kHz	W	680	840	980	1210	1640
8 kHz	W	880	1100	1280	1580	2140
at controller inhibit	W	25	25	25	30	30
Overcurrent cycle 180 s						
Max. output current	A	78	98	116	144	186
Overload time	s	60	60	60	60	60
Recovery time	s	120	120	120	120	120
Max. output current during the recovery time	A	39	49	58	72	93
Overcurrent cycle 15 s						
Max. output current	A	104	130	154	192	248
Overload time	s	3	3	3	3	3
Recovery time	s	12	12	12	12	12
Max. output current during the recovery time	A	39	49	58	72	93
Cyclic mains switching		3 times per minute			1 time per minute	
Brake chopper						
Max. output current	A	98	98	98	166	166
Min. brake resistance	Ω	7.5	7.5	7.5	4.7	4.7
Max. motor cable length shielded						
without EMC category	m	-	100	-		
Category C1 (2 kHz, 4 kHz, 8 kHz)	m	-				
Category C2	m	20				
Weight	kg	17.2			24	



15 Appendix

15.1 Operate and parameterise the inverter with keypad

The keypad is an easy means for the local operation, parameterisation, and diagnostics of the inverter.



- The keypad is simply connected to the diagnostic interface on the front of the inverter.
- The keypad can also be connected and removed during operation.

Appendix

Operate and parameterise the inverter with keypad
Keypad operating mode



15.1.1 Keypad operating mode

After switching on the inverter, the keypad plugged in is in "Operating mode" after a short initialisation phase.

15.1.1.1 Keypad status display

In the operating mode, the keypad displays information on the status of the inverter.

Keypad display	Display	Meaning
<p>If the inverter is inhibited, the keypad shows "STOP":</p> <p>If the inverter is enabled, the keypad shows the output frequency of the inverter:</p> <ul style="list-style-type: none"> In the process controller mode, instead of the output frequency, the process controller setpoint is displayed. The display can be configured in 0x2864 (P703.00). The language for the keypad display is preset to "English". The language can be changed in 0x2863 (P705.00). 	<p>① Active control mode:</p> <p>VEL Speed mode</p> <p>PID Process controller mode</p> <p>TRQ Torque mode</p> <p>JOG Manual mode</p> <p>② Active control source:</p> <p>FLEX Flexible I/O configuration</p> <p>KPD Keypad</p> <p>KPDF Keypad (complete control via keypad including setpoint selection)</p> <p>NET Network</p> <p>③ Active setpoint source:</p> <p>AINx Analog input x</p> <p>KPD Keypad</p> <p>NET Network</p> <p>FREQ Digital frequency</p> <p>PRx Preset setpoint x</p> <p>SEGx Segment x</p> <p>MOP Motor potentiometer</p> <p>④ Current direction of rotation:</p> <p>FWD Motor is rotating forwards</p> <p>REV Motor is rotating backwards</p> <p>⑤ Lower status line:</p> <p>LOC Local keypad control active.</p> <p>REM Remote control via terminals, network, etc. active.</p> <p>MAN Manual setpoint selection via keypad active.</p> <p>AUTO Automatic setpoint selection via terminals, network, etc. active.</p> <p>SET Blinking if one parameter setting has been changed but has not been saved in the memory module with mains failure protection. Save settings: Press keypad enter key longer than 3 s.</p>	
<p>If an error is pending, the keypad shows the following information:</p> <ul style="list-style-type: none"> Faults (F) and trouble (T) are displayed continuously. Warnings (W) are only displayed every 2 seconds for a short time. 	<p>① Error text</p> <p>② Error type:</p> <p>F Fault</p> <p>T Trouble</p> <p>W Warning</p> <p>③ Error code (hexadecimal)</p> <p>▶ Error codes 607</p> <p>▶ Error handling 113</p> <p>▶ Error reset with keypad 602</p>	
	<p>After a disturbance, a restart is possible if the error condition is not active anymore. The keypad shows this by the "Restart Pending" note. The note is displayed in a 1-second interval alternating with the error text.</p> <p>▶ Automatic restart 441</p>	



15.1.1.2 Function of keypad keys in operating mode

In the operating mode, the keypad can be used for local control and for manual setpoint selection.

Function of keypad keys in operating mode			
Key	Actuation	Condition	Action
	Shortly	Local keypad control active. Display "LOC"	Run motor.
		Remote control active Display "REM" Display "KSTOP"	Deactivate keypad triggered stop. The motor remains at standstill. Display changes from "KSTOP" to "STOP".
	Shortly	No Jog operation	Stop motor. Display "KSTOP"
	Shortly	Operating mode	Change to parameterisation mode. ▶ Keypad parameterisation mode □ 603
	More than 3 s	None (anytime possible)	Save parameter settings in the user memory of the memory module.
	Shortly	During operation	Scroll through information in the above status line.
 	Shortly	Manual setpoint selection via keypad active. Display "MAN"	Change frequency setpoint.
	Shortly	Local keypad control active. Display "LOC"	Reversal of rotation direction. Display "REV?" → Confirm with ▶ Keypad - Configuration of R/F and CTRL buttons □ 372

Example: Change setpoint

If the setpoints are selected manually via keypad, the frequency setpoint can be changed in the operating mode via the arrow keys (even while the motor is running):

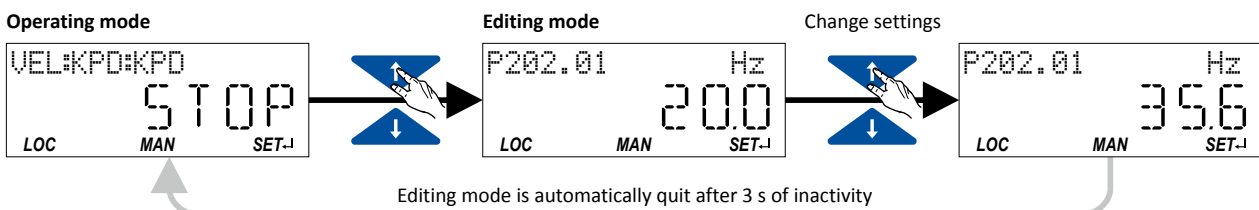

Appendix

Operate and parameterise the inverter with keypad
Keypad operating mode



15.1.1.3 Error reset with keypad

Use the  keypad key to reset a resettable error if the error condition no longer exists and no blocking time is active.

- The "Error codes" table gives the blocking time (if available) for each error. [607](#)

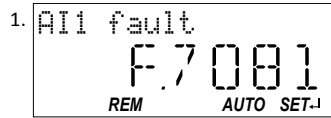

- Press  keypad key.

The error is reset. The motor remains stopped via keypad (display "KSTOP").



- In order to cancel the stop via keypad again: Press  keypad key.

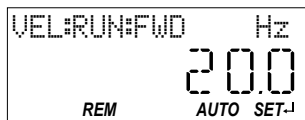



15.1.2 Keypad parameterisation mode

In the parameterisation mode of the keypad you can have actual values of the inverter displayed for purposes of diagnostics and change settings of the inverter.

Use the **←** to change from operating mode to the parameterisation mode.

- If a write access protection is active for the inverter, the keypad automatically displays a log-in when changing to the parameterisation mode. You can either skip the log-in and thus keep the access protection active or remove it temporarily by entering a valid PIN.
 - ▶ [Write access protection](#) □ 398
- Use the **↩** to return to the operating mode.

15.1.2.1 Parameter groups

In order to provide for quick access, all parameters of the inverter are divided into different groups according to their function.

- Group 0 contains the configurable "Favorites". In the default setting these are the most common parameters for the solution of typical applications. ▶ [Favorites](#) □ 407
- Based on the hundreds digit of the display code (Pxxx) you can quickly see in which group the parameter is to be found on the keypad:

Parameter	Group/name	Description
P1xx	Group 1 - Diagnostics	Diagnostic/display parameters for displaying device-internal process factors, current actual values, and status messages. ▶ Diagnostics parameter □ 85
P2xx	Group 2 - Basic setting	Setting of the mains voltage, selection of the control and setpoint source, starting and stopping performance, frequency limits and ramp times. ▶ Basic setting □ 118
P3xx	Group 3 - Motor control	Configuration of the motor and motor control ▶ Motor control □ 136
P4xx	Group 4 - I/O setting	Function assignment and configuration of the inputs and outputs ▶ Flexible I/O configuration □ 493
P5xx	Group 5 - Network setting	Configuration of the network (if available) ▶ Configuring the network □ 199
P6xx	Group 6 - Process controller	Configuration of the process controller ▶ Configuring the process controller □ 356
P7xx	Group 7 - Additional functions	Parameterisable additional functions ▶ Additional functions □ 365
P8xx	Group 8 - Sequencer	The "sequencer" function serves to define a programmed sequence of speed setpoints, PID setpoints or torque setpoints for the motor control. Switching to the next setpoint can be executed in a time-based or event-based manner. ▶ Sequencer □ 462

Appendix

Operate and parameterise the inverter with keypad
Keypad parameterisation mode



15.1.2.2 Function of the keypad keys in the parameterisation mode

In the parameterisation mode, the arrow keys serve to select and change parameters.

Function of the keypad keys in the parameterisation mode			
Key	Actuation	Condition	Action
	Shortly	Local keypad control active. Display "LOC"	Run motor.
		Remote control active Display "REM" Display "KSTOP"	Deactivate keypad triggered stop. The motor remains at standstill. Display changes from "KSTOP" to "STOP".
	Shortly	No Jog operation	Stop motor. Display "KSTOP"
	Shortly	Parameterisation mode	Navigate to one level below. Group level → Parameter level → [SUB parameter level] → Editing mode
		Editing mode	Exit editing mode and accept new setting.
	More than 3 s	None (anytime possible)	Save parameter settings in the user memory of the memory module.
	Shortly	Parameterisation mode	Navigate to one level above. [SUB parameter level] → Parameter level → Group level → Operating mode
		Editing mode	Abort: Exit editing mode without accepting new setting.
	Shortly	Group level/Parameter level	Navigate: Select group/parameter.
		Editing mode	Change parameter setting.
			Without function
			Without function

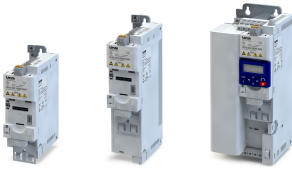

Changing inverter settings by means of the keypad (general operation)

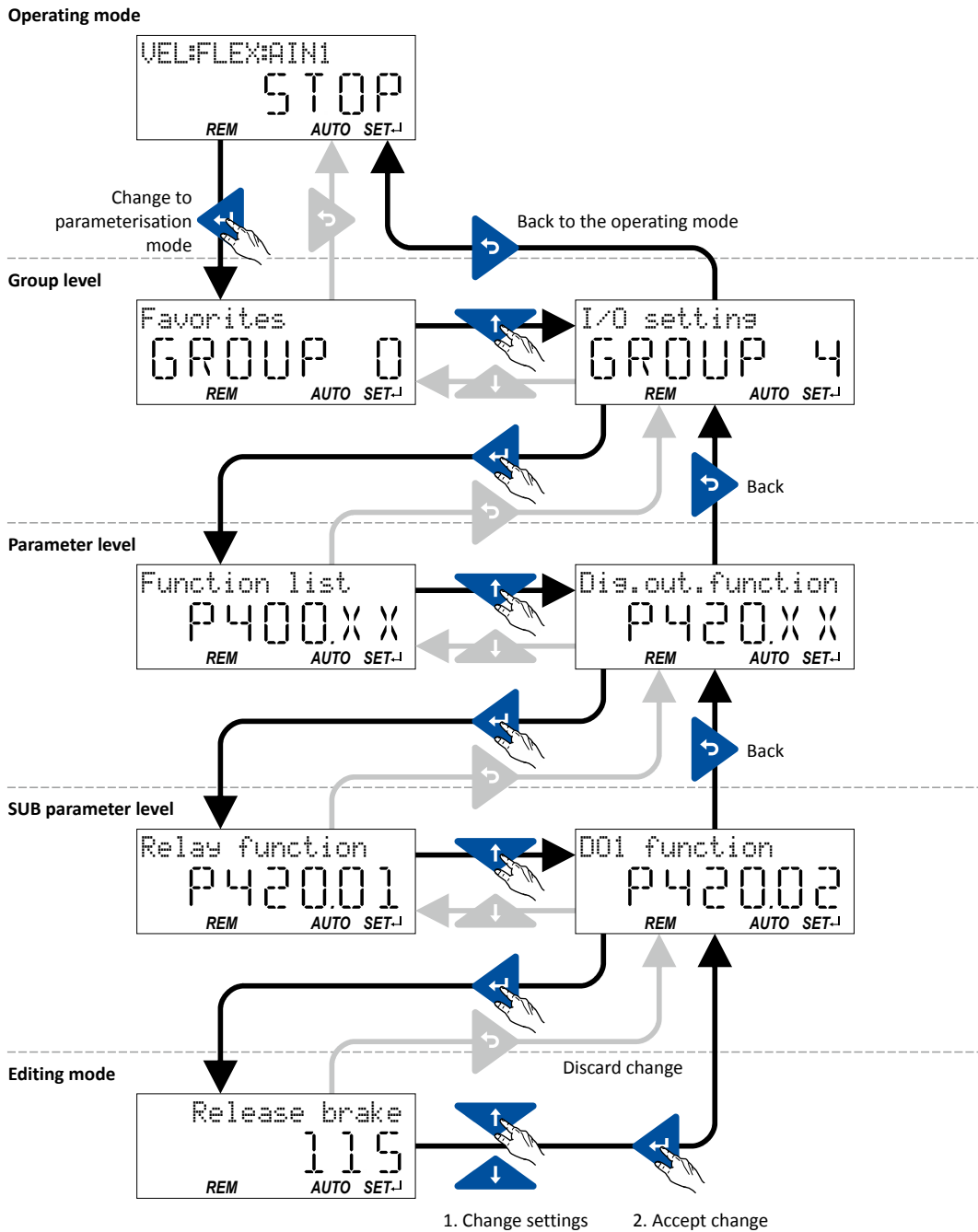

15.1.2.3 Save parameter settings with keypad

If one parameter setting has been changed with the keypad but has not been saved in the memory module with mains failure protection, the SET display is blinking.

In order to save parameter settings in the user memory of the memory module, press the keypad enter key longer than 3 s.



Appendix

Operate and parameterise the inverter with keypad
Keypad parameterisation mode



15.1.2.4 Display of status words on keypad

Some diagnostics parameters contain bit-coded status words. Each single bit has a certain meaning.

Display of 16-bit status words on the keypad

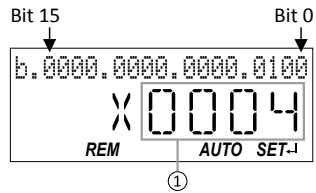

- ① Hexadecimal value

Display of 32-bit status words on the keypad

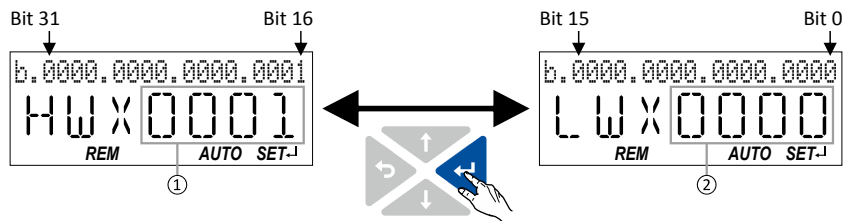

- ① Hexadecimal value High word (HW)
- ② Hexadecimal value Low word (LW)



15.2 Error codes

The following table contains all error codes of the inverter in ascending order.

Error code		Info		Error type	Adjustable in
dec	hex	Keypad display	Error message		
8784	0x2250	PU over current	CiA: Continuous over current (internal)	Fault	-
This message contains three errors: 1. Continuous overcurrent on the inverter/motor side. 2. Overcurrent at the brake chopper (brake transistor). 3. DC bus relay has not been closed due to a malfunction. Notes: <ul style="list-style-type: none"> • Serious error: The inverter is inhibited immediately. The motor becomes torqueless (coasts). • The error can only be reset after a blocking time of 5 s. 					
8992	0x2320	Earth leak	CiA: Short circuit/earth leakage (internal)	Fault	-
Notes: <ul style="list-style-type: none"> • Serious error: The inverter is inhibited immediately. The motor becomes torqueless (coasts). • The error can only be reset after a blocking time of 5 s. 					
9024	0x2340	Motor shorted	CiA: Short circuit (device internal)	Fault	-
Notes: <ul style="list-style-type: none"> • Serious error: The inverter is inhibited immediately. The motor becomes torqueless (coasts). • The error can only be reset after a blocking time of 5 s. 					
9040	0x2350	i2t motor	CiA: i ² *t overload (thermal state)	Fault	0x2D4B:003 (P308.03)
<ul style="list-style-type: none"> ▶ Motor overload monitoring (i²*t) 188 Notes: <ul style="list-style-type: none"> • The error can only be reset after a blocking time of 5 s. 					
9090	0x2382	Ixt error	I*t error	Fault	0x2D40:005 (P135.05)
The device utilisation has exceeded the warning threshold set in 0x2D40:002 (default setting: 95 %). <ul style="list-style-type: none"> ▶ Device overload monitoring (i*t) 111 Notes: <ul style="list-style-type: none"> • Serious error: The inverter is inhibited immediately. The motor becomes torqueless (coasts). • The error can only be reset after a blocking time of 3 s. 					
9091	0x2383	Ixt warning	I*t warning	Warning	-
The device utilisation has exceeded the permanent error threshold of 100 %. <ul style="list-style-type: none"> ▶ Device overload monitoring (i*t) 111 Notes: <ul style="list-style-type: none"> • Logging only (Error history buffer/Logbook) 					
9095	0x2387	Clamp timeout	Imax: Clamp responded too often	Fault	-
"Clamp" = short-time inhibit of the inverter in V/f operation when the current limit shown in 0x2DDF:002 is reached. Notes: <ul style="list-style-type: none"> • Serious error: The inverter is inhibited immediately. The motor becomes torqueless (coasts). 					
9096	0x2388	SLPSM stall det.	SLPSM stall detection active	Trouble	-
Stalling protection for the sensorless control for synchronous motors (SLPSM) is active. Possible cause: Overload of the motor. <ul style="list-style-type: none"> ▶ Stall monitoring 153 Notes: <ul style="list-style-type: none"> • Serious fault: The inverter is inhibited immediately. The motor becomes torqueless (coasts). 					
12576	0x3120	Mains Phase fail	Mains phase fault	Fault	-
Notes: <ul style="list-style-type: none"> • Serious error: The inverter is inhibited immediately. The motor becomes torqueless (coasts). 					

Appendix

Error codes



Error code		Info		Error type	Adjustable in
dec	hex	Keypad display	Error message		
12816	0x3210	DC Bus OV	DC bus overvoltage	Fault	-
		<p>The DC-bus voltage of the inverter has exceeded the error threshold for overvoltage. The error threshold results from the setting of the rated mains voltage in 0x2540:001 (P208.01).</p> <p>► Mains voltage □ 119</p> <p>Notes:</p> <ul style="list-style-type: none"> • Serious error: The inverter is inhibited immediately. The motor becomes torqueless (coasts). 			
12817	0x3211	Warn.DC Bus OV	DC bus overvoltage warning	Warning	-
		<p>The DC-bus voltage of the inverter has exceeded the warning threshold for overvoltage set in 0x2540:005 (P208.05).</p> <p>► Mains voltage □ 119</p> <p>Notes:</p> <ul style="list-style-type: none"> • Logging only (Error history buffer/Logbook) 			
12832	0x3220	DC Bus UV	DC bus undervoltage	Trouble	-
		<p>The DC-bus voltage of the inverter has fallen below the error threshold for undervoltage. The error threshold results from the setting of the rated mains voltage in 0x2540:001 (P208.01).</p> <p>► Mains voltage □ 119</p>			
12833	0x3221	Warn.DC Bus UV	DC bus undervoltage warning	Warning	-
		<p>The DC-bus voltage of the inverter has fallen below the warning threshold for undervoltage set in 0x2540:002 (P208.02).</p> <p>► Mains voltage □ 119</p> <p>Notes:</p> <ul style="list-style-type: none"> • Logging only (Error history buffer/Logbook) 			
12834	0x3222	DC-bus on-UV	DC-bus voltage to low for power up	Warning	-
		<p>Notes:</p> <ul style="list-style-type: none"> • Logging only (Error history buffer/Logbook) 			
16912	0x4210	PU Overtemp.	PU: overtemperature fault	Fault	-
		<p>Temperature monitoring of the power unit has been triggered.</p> <p>Possible causes:</p> <ul style="list-style-type: none"> • Ambient temperature too high. • Fan or ventilation slots are polluted. • Fan is defective. <p>Remedies:</p> <ul style="list-style-type: none"> • Provide for a sufficient cooling of the device. • Clean fan and ventilation slots. • If required, replace fan. • Set a variable switching frequency in for the inverter. The switching frequency is then automatically reduced if the output current or temperature of the power unit are too high. 			
17024	0x4280	Heatsink sensor	Heat sink temperature sensor fault	Fault	-
		<p>The sensor for temperature monitoring of the power unit provides implausible measured values. This indicates a hardware defect of the sensor.</p> <p>As a result of the failure of the temperature monitoring, there is a risk of fire by overheating!</p> <p>This error cannot be corrected by the user → Consultation with the manufacturer is required.</p>			
17025	0x4281	Heatsink fan	Heat sink fan warning	Warning	-
		<p>Notes:</p> <ul style="list-style-type: none"> • Logging only (Error history buffer/Logbook) 			
17029	0x4285	Warn.PU Overtemp	PU overtemperature warning	Warning	-
		<p>The temperature of the power section has exceeded the warning threshold for overtemperature.</p> <p>Notes:</p> <ul style="list-style-type: none"> • Logging only (Error history buffer/Logbook) 			
17168	0x4310	Overtemp. motor	Motor temperature error	Fault	0x2D49:002 (P309.02)
		<p>Notes:</p> <ul style="list-style-type: none"> • The error can only be reset after a blocking time of 5 s. 			



Error code		Info		Error type	Adjustable in
dec	hex	Keypad display	Error message		
20754	0x5112	24V supply low	24 V supply critical	Warning	-
		Notes: • Logging only (Error history buffer/Logbook)			
20864	0x5180	Overlaod 24V	Overload 24 V supply	Warning	-
		Notes: • Logging only (Error history buffer/Logbook)			
21376	0x5380	Incomp. OEM HW	OEM hardware incompatible	Fault	-
		Notes: • Serious error: The inverter is inhibited immediatly. The motor becomes torqueless (coasts). • The error can only be reset by mains switching.			
24592	0x6010	Watchdog timeout	Watchdog time-out	Warning	-
		Notes: • Logging only (Error history buffer/Logbook)			
24961	0x6181	Timeout-125usTsk	Time-out in 125 us task	Fault	-
		Notes: • Serious error: The inverter is inhibited immediatly. The motor becomes torqueless (coasts). • The error can only be reset by mains switching.			
24962	0x6182	Timeout-250usTsk	Time-out in 250 us task	Fault	-
		Notes: • Serious error: The inverter is inhibited immediatly. The motor becomes torqueless (coasts). • The error can only be reset by mains switching.			
24963	0x6183	Timeout-1ms-Task	Time-out in 1 ms task	Fault	-
		Notes: • Serious error: The inverter is inhibited immediatly. The motor becomes torqueless (coasts). • The error can only be reset by mains switching.			
24964	0x6184	Timeout-8ms-Task	Time-out in 8 ms task	Fault	-
		Notes: • Serious error: The inverter is inhibited immediatly. The motor becomes torqueless (coasts). • The error can only be reset by mains switching.			
24968	0x6188	Internal error	Internal error	Fault	-
		Notes: • Serious error: The inverter is inhibited immediatly. The motor becomes torqueless (coasts). • The error can only be reset by mains switching.			
24969	0x6189	PU Prog. error	PU: programming fault	Fault	-
		Notes: • Serious error: The inverter is inhibited immediatly. The motor becomes torqueless (coasts).			
24970	0x618A	Internal fan	Internal fan warning	Warning	-
		Notes: • Logging only (Error history buffer/Logbook)			
24976	0x6190	PU comm mismatch	PU: communication mismatch	Fault	-
		Notes: • Serious error: The inverter is inhibited immediatly. The motor becomes torqueless (coasts).			
24977	0x6191	PU Sync. Fault	PU: communication not synchronous	Trouble	-
		Notes: • Serious fault: The inverter is inhibited immediatly. The motor becomes torqueless (coasts).			
24978	0x6192	Comm.error PU-CU	Communication error PU-CU	Trouble	-
		Notes: • Serious fault: The inverter is inhibited immediatly. The motor becomes torqueless (coasts).			

Appendix

Error codes



Error code		Info		Error type	Adjustable in
dec	hex	Keypad display	Error message		
24979	0x6193	PU comm error	PU: communication error	Fault	-
		<p>If this error occurs, the motor may not be able to be brought to standstill anymore. If communication is lost completely, the power output stage will switch off.</p> <p>Notes:</p> <ul style="list-style-type: none"> • Serious error: The inverter is inhibited immediately. The motor becomes torqueless (coasts). 			
24980	0x6194	PU SDO comm err.	SDO communication with PU aborted	Fault	-
		<p>Notes:</p> <ul style="list-style-type: none"> • Serious error: The inverter is inhibited immediately. The motor becomes torqueless (coasts). 			
24981	0x6195	I2C conn. error	I2C connection lost	Warning	-
		<p>Notes:</p> <ul style="list-style-type: none"> • Logging only (Error history buffer/Logbook) 			
24982	0x6196	I2C bus error	I2C bus error	Warning	-
		<p>Notes:</p> <ul style="list-style-type: none"> • Logging only (Error history buffer/Logbook) 			
25008	0x61B0	PU uC supply err	PU: uC supply voltage drop down	Fault	-
		<p>A supply voltage drop for the microprocessor of the power unit has been detected.</p>			
25009	0x61B1	PU general error	PU: general error	Fault	-
		<p>Notes:</p> <ul style="list-style-type: none"> • Serious error: The inverter is inhibited immediately. The motor becomes torqueless (coasts). 			
25216	0x6280	P400 config err	Trigger/functions connected incorrectly	Trouble	-
		<p>The assignment directives have not been observed:</p> <ul style="list-style-type: none"> • If the "flexible I/O configuration" is active as control source, the "Enable inverter" function or the "Run" function must be connected to a digital input in order that the motor can be stopped again any time! • In case of keypad or network control, the two functions "Enable inverter" and "Run" can also be set to "Constant TRUE [1]" to start the motor. • The use of the "Start forward (CW)" and "Start reverse (CCW)" functions excludes the use of the "Run forward (CW)" and "Run reverse (CCW)" and vice versa. <p>▶ Start / stop motor 499</p>			
25217	0x6281	User fault 1	User-defined fault 1	Fault	-
		<p>The "Activate fault 1" function was triggered via the flexible I/O configuration. The error can only be reset after the function has been deactivated again.</p> <p>▶ Triggering a user-defined fault 549</p>			
25218	0x6282	User fault 2	User-defined fault 2	Fault	-
		<p>The "Activate fault 2" function was triggered via the flexible I/O configuration. The error can only be reset after the function has been deactivated again.</p> <p>▶ Triggering a user-defined fault 549</p>			
25232	0x6290	Invert rotation	Warning invert rotation	Warning	-
		<p>The "Invert rotation" function was requested with an active limitation of rotation. ▶ Motor rotating direction 185</p> <p>Notes:</p> <ul style="list-style-type: none"> • Logging only (Error history buffer/Logbook) 			
25233	0x6291	Trouble overflow	Maximum allowed troubles exceeded	Fault	-
		<p>▶ Automatic restart 441</p>			
25248	0x62A0	AC Dr. UserFault	AC Drive: user fault	Fault	-
		<p>The "Activate fault" function was triggered via the AC drive control word. The error can only be reset after the function has been deactivated again.</p>			
25249	0x62A1	Netw.UserFault 1	Network: user fault 1	Fault	-
		<p>The "Activate fault 1" function was triggered via the NetWordIN1 data word. The error can only be reset after the function has been deactivated again.</p> <p>▶ Further process data 226</p>			
25250	0x62A2	Netw.UserFault 2	Network: user fault 2	Fault	-
		<p>The "Activate fault 2" function was triggered via the NetWordIN1 data word. The error can only be reset after the function has been deactivated again.</p> <p>▶ Further process data 226</p>			

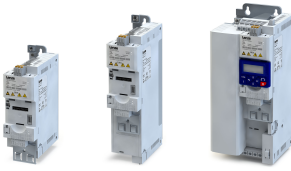

Error code		Info		Error type	Adjustable in
dec	hex	Keypad display	Error message		
25265	0x62B1	NetWordIN1 error	NetWordIN1 configuration incorrect	Trouble	-
		Two bits of the NetWordIN1 data word were assigned to the same function. Remedy: Check and correct the NetWordIN1 data word. The functions that are to be triggered via bit 0 ... 15 of the NetWordIN1 data word, are defined in 0x400E:001 (P505.01) ... 0x400E:016 (P505.16) .			
25504	0x63A0	EEPROM fault	On-board EEPROM: access error	Fault	-
		Notes: <ul style="list-style-type: none"> • Serious error: The inverter is inhibited immediately. The motor becomes torqueless (coasts). • The error can only be reset by mains switching. 			
25505	0x63A1	CU ID tag error	CU: load error ID tag	Fault	-
		Notes: <ul style="list-style-type: none"> • Serious error: The inverter is inhibited immediately. The motor becomes torqueless (coasts). • The error can only be reset by mains switching. 			
25506	0x63A2	PU ID tag error	PU: load error ID tag	Fault	-
		Notes: <ul style="list-style-type: none"> • Serious error: The inverter is inhibited immediately. The motor becomes torqueless (coasts). • The error can only be reset by mains switching. 			
25507	0x63A3	PU unknown	Power unit unknown	Fault	-
		Notes: <ul style="list-style-type: none"> • Serious error: The inverter is inhibited immediately. The motor becomes torqueless (coasts). • The error can only be reset by mains switching. 			
25508	0x63A4	EEPROM overflow	On-board EEPROM: timer overflow	Warning	-
		Notes: <ul style="list-style-type: none"> • Logging only (Error history buffer/Logbook) 			
28800	0x7080	Assertionlevel	Assertion level monitoring (Low/High)	Fault	-
		The last setting of the connection level differs from the saved setting. Remedy: <ol style="list-style-type: none"> 1. Check setting in 0x2630:001 (P410.01). 2. Execute device command "Save user data" 0x2022:003 (P700.03). 3. Switch inverter off and on again. 			
28801	0x7081	AI1 fault	Analog input 1 fault	Fault	0x2636:010 (P430.10)
		The monitoring of the input signal configured for the analog input 1 has been triggered. ▶ Analog input 1 568			
28802	0x7082	AI2 fault	Analog input 2 fault	Fault	0x2637:010 (P431.10)
		The monitoring of the input signal configured for the analog input 2 has been triggered. ▶ Analog input 2 572			
28803	0x7083	HTL input fault	HTL input fault	Warning	0x2641:006 (P416.06)
		The monitoring of the input signal configured for the HTL input has been triggered. ▶ HTL input setpoint source 534 Notes: <ul style="list-style-type: none"> • When the error type is set to "Warning", only logging takes place (Error history buffer/Logbook) 			
28833	0x70A1	AO1 fault	Analog output 1 fault	Warning	-
		Notes: <ul style="list-style-type: none"> • Logging only (Error history buffer/Logbook) 			
28834	0x70A2	AO2 fault	Analog output 2 fault	Warning	-
		Notes: <ul style="list-style-type: none"> • Logging only (Error history buffer/Logbook) 			
28961	0x7121	Pole pos. error	Pole position identification fault	Fault	0x2C60
		Notes: <ul style="list-style-type: none"> • Serious error: The inverter is inhibited immediately. The motor becomes torqueless (coasts). 			
29056	0x7180	Mot max current	Motor overcurrent	Fault	0x2D46:002 (P353.02)
		Notes: <ul style="list-style-type: none"> • The error can only be reset after a blocking time of 1 s. 			

Appendix

Error codes



Error code		Info		Error type	Adjustable in
dec	hex	Keypad display	Error message		
29445	0x7305	Encoder error	Encoder open circuit	Warning	0x2C45 (P342.00)
		<p>The encoder signal loss monitoring has detected a failure of the encoder signal (e. g. due to open circuit or failure of the encoder current supply).</p> <p>▶ Encoder monitoring 452</p> <p>Notes:</p> <ul style="list-style-type: none"> When the error type is set to "Warning", only logging takes place (Error history buffer/Logbook) 			
29573	0x7385	F.fdb spd limit	Feedback system: speed limit	Warning	-
		<p>The calculated encoder maximum frequency is beyond the permissible frequency range of the digital inputs.</p> <p>▶ Encoder monitoring 452</p> <p>Notes:</p> <ul style="list-style-type: none"> Logging only (Error history buffer/Logbook) 			
30336	0x7680	EPM full	Memory module is full	Warning	-
		<p>The memory module contains too many parameter settings. The inverter copies the current backup to the user memory without overwriting the data in the RAM.</p> <p>Remedy: Execute device command "Save user data" 0x2022:003 (P700.03) again. This reinitialises the user memory with the current parameter settings. By this means, parameter settings no longer required are deleted automatically.</p> <p>Notes:</p> <ul style="list-style-type: none"> Logging only (Error history buffer/Logbook) 			
30337	0x7681	EPM not present	Memory module not present	Fault	-
		<p>The default setting saved in the inverter firmware is loaded. The error cannot be reset by the user.</p> <p>Remedy:</p> <ol style="list-style-type: none"> Switch off inverter. Plug the memory module into the inverter. Switch the inverter on again. 			
30338	0x7682	EPM invalid data	Memory module invalid user data	Fault	-
		<p>The user parameter settings are invalid both in the user memory and in the backup. Thus, the user parameter settings are lost. The default setting is loaded automatically.</p> <p>Remedy:</p> <ol style="list-style-type: none"> Execute user parameter settings again. Execute device command "Save user data" 0x2022:003 (P700.03). <p>Notes:</p> <ul style="list-style-type: none"> Serious error: The inverter is inhibited immediately. The motor becomes torqueless (coasts). 			
30340	0x7684	Save incomplete	Data not compl. saved before powerdown	Warning	-
		<p>Saving the parameter settings was interrupted by an unexpected disconnection. The user parameter settings were not saved completely. When the inverter is switched on the next time, the backup data is copied to the user memory.</p> <p>Remedy:</p> <ol style="list-style-type: none"> Check user parameter settings. (The loaded backup is an older version.) If required, repeat the changes made last. Execute device command "Save user data" 0x2022:003 (P700.03). <p>Notes:</p> <ul style="list-style-type: none"> Logging only (Error history buffer/Logbook) 			
30342	0x7686	Net.config.error	Network: configuration error	Fault	-
		<p>The expected network option is missing. This error can only occur if the control unit has been replaced by a control unit with different features.</p> <p>Remedy:</p> <ol style="list-style-type: none"> Switch off inverter. Install control unit with matching network option. Switch the inverter on again. <p>Notes:</p> <ul style="list-style-type: none"> Serious error: The inverter is inhibited immediately. The motor becomes torqueless (coasts). 			

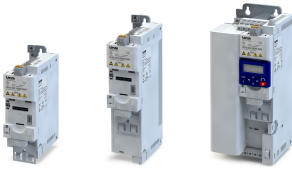

Error code		Info		Error type	Adjustable in
dec	hex	Keypad display	Error message		
30343	0x7687	EPM timer overfl	Memory module: timer overflow	Warning	-
		During the read/write access to the memory module, a time-out has occurred, e.g. because the memory module has been removed. Notes: <ul style="list-style-type: none"> Logging only (Error history buffer/Logbook) 			
30345	0x7689	OEM data invalid	Memory module: invalid OEM data	Warning	-
		The OEM memory contains invalid parameter settings or is empty. The user parameter settings are loaded automatically. Remedy: <ul style="list-style-type: none"> Execute device command "Save OEM data" 0x2022:006 (P700.06). Thus, the user parameter settings get lost! Notes: <ul style="list-style-type: none"> Logging only (Error history buffer/Logbook) 			
30346	0x768A	Wrong EPM	Memory module: wrong type	Fault	-
		The plugged-in memory module is not supported by the inverter. The default setting saved in the inverter firmware is loaded. The error cannot be reset by the user. Remedy: <ol style="list-style-type: none"> Switch off inverter. Replace plugged-in memory module by a memory module that matches the inverter. Switch the inverter on again. 			
30352	0x7690	EPM-FW incomp.	EPM firmware version incompatible	Fault	-
		The parameter settings saved in the memory module do not match the firmware version. The data are loaded into the RAM memory, but are incompatible. Remedy: <ol style="list-style-type: none"> Execute device command "Load default settings" 0x2022:001 (P700.01). Execute device command "Save user data" 0x2022:003 (P700.03) or "Save OEM data" 0x2022:006 (P700.06) in order that the error does not occur at the next switch-on. 			
30353	0x7691	EPM: FW incomp.	EPM data: firmware type incompatible	Fault	-
		The parameter settings saved in the memory module do not match the firmware type. The data are loaded into the RAM memory, but are incompatible. Remedy: <ol style="list-style-type: none"> Execute device command "Load default settings" 0x2022:001 (P700.01). Execute device command "Save user data" 0x2022:003 (P700.03) or "Save OEM data" 0x2022:006 (P700.06) in order that the error does not occur at the next switch-on. 			
30354	0x7692	UserCU not match	EPM data: new firmware type detected	Fault	-
		The parameter settings saved in the memory module do not match in the inverter hardware. The data is loaded into the RAM memory and is compatible. However, the settings must be accepted by the user: <ol style="list-style-type: none"> Reset error. Execute device command "Save user data" 0x2022:003 (P700.03) or "Save OEM data" 0x2022:006 (P700.06) in order that the error does not occur at the next switch-on. Alternatively, the default setting can be loaded and then saved. 			
30355	0x7693	EPM PU size inco	EPM data: PU size incompatible	Fault	-
		The parameter settings saved in the memory module do not match the power unit. The data are loaded into the RAM memory, but are incompatible. Remedy: <ol style="list-style-type: none"> Execute device command "Load default settings" 0x2022:001 (P700.01). Execute device command "Save user data" 0x2022:003 (P700.03) or "Save OEM data" 0x2022:006 (P700.06) in order that the error does not occur at the next switch-on. 			
30356	0x7694	EPM new PU size	EPM data: new PU size detected	Fault	-
		The parameter settings saved in the memory module do not match in the inverter hardware. The data is loaded into the RAM memory and is compatible. However, the settings must be accepted by the user: <ol style="list-style-type: none"> Reset error. Execute device command "Save user data" 0x2022:003 (P700.03) or "Save OEM data" 0x2022:006 (P700.06) in order that the error does not occur at the next switch-on. Alternatively, the default setting can be loaded and then saved. 			



Error code		Info		Error type	Adjustable in
dec	hex	Keypad display	Error message		
30357	0x7695	InvalidChgvrCfg	Invalid parameter changeover configuration	Warning	-
		<p>One or several parameters cannot be used for the "parameter change-over" function. The parameter change-over is deactivated.</p> <p>Remedy:</p> <ul style="list-style-type: none"> Check error message for parameter change-over in 0x4047:001 (P756.01) and correct the list entry displayed in 0x4047:002 (P756.02). <p>Notes:</p> <ul style="list-style-type: none"> Logging only (Error history buffer/Logbook) 			
30358	0x7696	Unkn. Par in EPM	EPM data: unknown parameter found	Info	-
		<p>The memory module contains parameter settings for one or several parameters that are not known to the inverter.</p> <p>Remedy: Execute device command "Save user data" 0x2022:003 (P700.03). This reinitialises the user memory with the current parameter settings. By this means, parameter settings no longer required are deleted automatically.</p> <p>Notes:</p> <ul style="list-style-type: none"> Information only. 			
30359	0x7697	Parameter loss	Parameter changes lost	Fault	-
		<p>Changed parameter settings got lost due to the removal of the 24-V voltage supply.</p> <p>In order to reset the error, there are the following options:</p> <ul style="list-style-type: none"> Execute device command "Load default settings" 0x2022:001 (P700.01). Execute device command "Save user data" 0x2022:003 (P700.03). Switch inverter off and on again without plugged-in USB module. <p>Notes:</p> <ul style="list-style-type: none"> Serious error: The inverter is inhibited immediately. The motor becomes torqueless (coasts). 			
33042	0x8112	TO expl. msg	Network: timeout explicit message	Warning	0x2859:006 (P515.06)
		<p>Notes:</p> <ul style="list-style-type: none"> When the error type is set to "Warning", only logging takes place (Error history buffer/Logbook) 			
33044	0x8114	TO overall comm	Network: overall communication timeout	Warning	See "Info" column
		<p>Notes:</p> <ul style="list-style-type: none"> When the error type is set to "Warning", only logging takes place (Error history buffer/Logbook) <p>Setting parameters:</p> <ul style="list-style-type: none"> 0x2859:007 (P515.07) ▶ EtherNet/IP monitoring □ 293 0x2859:007 (P515.07) ▶ Time-out behaviour □ 312 			
33045	0x8115	Time-out (PAM)	Time-out (PAM)	No response	0x2552:004 (P595.04)
		<p>The parameter access monitoring has been triggered.</p> <p>▶ Parameter access monitoring (PAM) □ 231</p>			
33046	0x8116	MBTCP mast t-out	Modbus TCP master time-out	Fault	0x2859:008 (P515.08)
33047	0x8117	MB.Keep Alive TO	Modbus TCP Keep Alive time-out	Fault	0x2859:009 (P515.09)
33154	0x8182	CAN bus off	CAN: bus off	Trouble	0x2857:010
		<p>A change to the "Bus-Off" state has been made.</p>			
33155	0x8183	CAN bus warning	CAN: warning	Warning	0x2857:011
		<p>Notes:</p> <ul style="list-style-type: none"> When the error type is set to "Warning", only logging takes place (Error history buffer/Logbook) 			
33156	0x8184	CAN heartb. C1	CAN: heartbeat time-out consumer 1	Fault	0x2857:005
		<p>▶ CANopen heartbeat protocol □ 237</p>			
33157	0x8185	CAN heartb. C2	CAN: heartbeat time-out consumer 2	Fault	0x2857:006
		<p>▶ CANopen heartbeat protocol □ 237</p>			
33158	0x8186	CAN heartb. C3	CAN: heartbeat time-out consumer 3	Fault	0x2857:007
		<p>▶ CANopen heartbeat protocol □ 237</p>			
33159	0x8187	CAN heartb. C4	CAN: heartbeat time-out consumer 4	Fault	0x2857:008
		<p>▶ CANopen heartbeat protocol □ 237</p>			

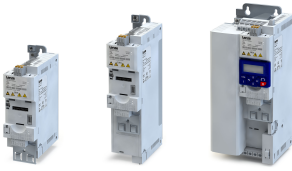







Error code		Info		Error type	Adjustable in
dec	hex	Keypad display	Error message		
33168	0x8190	Watchdog timeout	Network: watchdog timeout	Fault	See "Info" column
		Setting parameters: <ul style="list-style-type: none"> • 0x2859:001 (P515.01) ▶ PROFIBUS monitoring □ 269 • 0x2859:001 (P515.01) ▶ EtherCAT monitoring □ 347 • 0x2859:001 (P515.01) ▶ EtherNet/IP monitoring □ 293 • 0x2859:001 (P515.01) ▶ PROFINET monitoring □ 334 			
33169	0x8191	Cycl data error	Network: disruption of cyclic data exchange	No response	0x2859:002 (P515.02)
		The communication partner has interrupted the cyclic data exchange.			
33170	0x8192	Net. Init. error	Network: initialisation error	Fault	See "Info" column
		Setting parameters: <ul style="list-style-type: none"> • 0x2859:004 (P515.04) ▶ PROFIBUS monitoring □ 269 • 0x2859:004 (P515.04) ▶ EtherCAT monitoring □ 347 • 0x2859:004 (P515.04) ▶ EtherNet/IP monitoring □ 293 • 0x2859:004 (P515.04) ▶ PROFINET monitoring □ 334 • 0x2859:004 (P515.04) ▶ Time-out behaviour □ 312 			
33171	0x8193	Inv. cyclic data	Network: invalid cyclic process data	Trouble	See "Info" column
		Setting parameters: <ul style="list-style-type: none"> • 0x2859:005 (P515.05) ▶ PROFIBUS monitoring □ 269 • 0x2859:005 (P515.05) ▶ EtherCAT monitoring □ 347 • 0x2859:005 (P515.05) ▶ EtherNet/IP monitoring □ 293 • 0x2859:005 (P515.05) ▶ PROFINET monitoring □ 334 			
33184	0x81A0	Modbus TX error	Modbus transmit message error	Warning	-
		Notes: <ul style="list-style-type: none"> • Logging only (Error history buffer/Logbook) 			
33185	0x81A1	Modbus time-out	Modbus: network time-out	Fault	0x2858:001 (P515.01)
		No valid messages have been received via the Modbus for a longer time than the time-out time set in 0x2858:002 (P515.02) .			
33186	0x81A2	Modbus request	Modbus: incorrect request by master	Warning	-
		Notes: <ul style="list-style-type: none"> • Logging only (Error history buffer/Logbook) 			
33200	0x81B0	iCIF disconnect.	iCIF connection lost	Fault	-
		In case of the Ethernet communication interface, an internal software error has occurred. Remedy: <ul style="list-style-type: none"> • Switch inverter off and on again. • In the unlikely event of a power failure during a firmware download, it is required to reload the firmware via the USB module and then restart the inverter. ▶ Firmware download with »EASY Starter (Firmware loader)« □ 456 			
33414	0x8286	PDO map error	Network: PDO mapping error	Fault	See "Info" column
		Setting parameters: <ul style="list-style-type: none"> • 0x2859:003 (P515.03) ▶ PROFIBUS monitoring □ 269 • 0x2859:003 (P515.03) ▶ EtherCAT monitoring □ 347 • 0x2859:003 (P515.03) ▶ EtherNet/IP monitoring □ 293 • 0x2859:003 (P515.03) ▶ PROFINET monitoring □ 334 • 0x2859:003 (P515.03) ▶ Time-out behaviour □ 312 			
33425	0x8291	Timeout RPDO1	CAN: RPDO1 time-out	Fault	0x2857:001
		The RPDO was not received within the monitoring time set for the RPDO or not with the configured sync. ▶ CANopen process data objects □ 239			
33426	0x8292	Timeout RPDO2	CAN: RPDO2 time-out	Fault	0x2857:002
		The RPDO was not received within the monitoring time set for the RPDO or not with the configured sync. ▶ CANopen process data objects □ 239			
33427	0x8293	Timeout RPDO3	CAN: RPDO3 time-out	Fault	0x2857:003
		The RPDO was not received within the monitoring time set for the RPDO or not with the configured sync. ▶ CANopen process data objects □ 239			

Appendix

Error codes



Error code		Info		Error type	Adjustable in
dec	hex	Keypad display	Error message		
33553	0x8311	Torque limit	Torque limit reached	No response	0x2D67:001 (P329.01)
		The maximum possible torque has been reached and the deceleration time set in 0x2D67:002 (P329.02) has elapsed. ▶ Motor torque monitoring  197			
36992	0x9080	Keypad removed	Keypad removed	Fault	-
		The keypad was removed while the keypad control was activated. Remedy: <ul style="list-style-type: none"> • Plug on the keypad again or • activate another control source. ▶ Control source change-over  494			
65282	0xFF02	BrkResistor OL.F	Brake resistor: overload fault	Fault	0x2550:011 (P707.11)
		The calculated thermal load of the brake resistor has reached the permanent error threshold 100 %. The regenerative energy is too high. The error status will be reset if the thermal load falls below the error threshold of - 20 %. ▶ Use of a brake resistor  393 Notes: <ul style="list-style-type: none"> • The error can only be reset after a blocking time of 5 s. 			
65285	0xFF05	STO error	Safe Torque Off error	Fault	-
		Notes: <ul style="list-style-type: none"> • Serious error: The inverter is inhibited immediately. The motor becomes torqueless (coasts). • The error can only be reset by mains switching. 			
65286	0xFF06	Motor overspeed	Motor overspeed	Fault	0x2D44:002 (P350.02)
		The motor speed has reached the error threshold for overspeed set in . ▶ Motor speed monitoring  197 Notes: <ul style="list-style-type: none"> • The error can only be reset after a blocking time of 1 s. 			
65289	0xFF09	Mot.Phase miss.	Motor phase missing	No response	0x2D45:001 (P310.01)
		A failure of several motor phases has been detected. Remedy: <ul style="list-style-type: none"> • Check wiring between inverter and motor. • In case of a false tripping, adapt the settings for the motor phase failure detection. ▶ Motor phase failure detection  196 Notes: <ul style="list-style-type: none"> • The error can only be reset after a blocking time of 2 s. 			
65290	0xFF0A	Phase U failure	Motor phase failure phase U	No response	0x2D45:001 (P310.01)
		A failure of the motor phase U has been detected. Remedy: <ul style="list-style-type: none"> • Check wiring between inverter and motor. • In case of a false tripping, adapt the settings for the motor phase failure detection. ▶ Motor phase failure detection  196 Notes: <ul style="list-style-type: none"> • The error can only be reset after a blocking time of 2 s. 			
65291	0xFF0B	Phase V failure	Motor phase failure phase V	No response	0x2D45:001 (P310.01)
		A failure of the motor phase V has been detected. Remedy: <ul style="list-style-type: none"> • Check wiring between inverter and motor. • In case of a false tripping, adapt the settings for the motor phase failure detection. ▶ Motor phase failure detection  196 Notes: <ul style="list-style-type: none"> • The error can only be reset after a blocking time of 2 s. 			



Error code		Info		Error type	Adjustable in
dec	hex	Keypad display	Error message		
65292	0xFF0C	Phase W failure	Motor phase failure phase W	No response	0x2D45:001 (P310.01)
		<p>A failure of the motor phase W has been detected.</p> <p>Remedy:</p> <ul style="list-style-type: none"> • Check wiring between inverter and motor. • In case of a false tripping, adapt the settings for the motor phase failure detection. <p>▶ Motor phase failure detection 196</p> <p>Notes:</p> <ul style="list-style-type: none"> • The error can only be reset after a blocking time of 2 s. 			
65305	0xFF19	Motor ID fault	Motor parameter identification fault	Fault	-
		<p>During the automatic identification of the motor, an error has occurred.</p>			
65334	0xFF36	BrkResistor OL.W	Brake resistor: overload warning	Warning	0x2550:010 (P707.10)
		<p>The calculated thermal load of the brake resistor has reached the warning threshold set in 0x2550:008 (P707.08). The regenerative energy is too high.</p> <p>The warning status is reset if the thermal load falls below the warning threshold of - 20 %.</p> <p>▶ Use of a brake resistor 393</p> <p>Notes:</p> <ul style="list-style-type: none"> • When the error type is set to "Warning", only logging takes place (Error history buffer/Logbook) 			
65335	0xFF37	Auto start disab	Automatic start disabled	Fault	-
		<p>When the mains power was switched on, there was already a start command and the automatic start at power-up is set to "Off [0]" in 0x2838:002 (P203.02).</p> <p>Remedy:</p> <ul style="list-style-type: none"> • Deactivate start command and reset error. 			
65366	0xFF56	Max. motor freq.	Maximum motor frequency reached	Warning	-
		<p>The maximum motor speed set in 0x6080 (P322.00) is active.</p> <p>Notes:</p> <ul style="list-style-type: none"> • Logging only (Error history buffer/Logbook) 			
65413	0xFF85	Keypad full ctrl	Keypad full control active	Warning	-
		<p>The "Keypad Full Control" control mode is active. Both the control and the setpoint selection are made via the keypad. A renewed click of the keypad key CTRL serves to stop the control mode again.</p> <p>▶ Keypad - Configuration of R/F and CTRL buttons 372</p> <p>Notes:</p> <ul style="list-style-type: none"> • Logging only (Error history buffer/Logbook) 			



15.3 Parameter attribute list

The parameter attribute list in particular contains some information required for reading and writing parameters via network.

- The parameter attribute list contains all parameters of the inverter.
- The parameter attribute list is sorted by addresses (index:subindex) in ascending order.

How to read the parameter attribute list:

Column	Meaning																								
Address	Address of the parameter in the object directory. Format: index:subindex If the parameter can also be accessed via keypad, the "Display Code" is given in addition in brackets.																								
Name	Parameter name																								
Default setting	Default setting of the parameter																								
Category	Functional assignment of the parameter, for example "motor control" or "CANopen".																								
Data type	Data type of the parameter: <table border="1"> <tr><td>I8</td><td>1 byte, with sign</td></tr> <tr><td>I16</td><td>2 bytes with sign</td></tr> <tr><td>I32</td><td>4 bytes with sign</td></tr> <tr><td>I64</td><td>8 bytes with sign</td></tr> <tr><td>U8</td><td>1 byte without sign</td></tr> <tr><td>U16</td><td>2 bytes without sign</td></tr> <tr><td>U32</td><td>4 bytes without sign</td></tr> <tr><td>U64</td><td>8 bytes without sign</td></tr> <tr><td>REAL32</td><td>4 bytes floating point</td></tr> <tr><td>STRING[xx]</td><td>ASCII string (with character length xx)</td></tr> <tr><td>OCTET[xx]</td><td>OCTET string (with xx bytes)</td></tr> <tr><td>IDX</td><td>4 bytes without sign. Is used specially for addressing parameters.</td></tr> </table>	I8	1 byte, with sign	I16	2 bytes with sign	I32	4 bytes with sign	I64	8 bytes with sign	U8	1 byte without sign	U16	2 bytes without sign	U32	4 bytes without sign	U64	8 bytes without sign	REAL32	4 bytes floating point	STRING[xx]	ASCII string (with character length xx)	OCTET[xx]	OCTET string (with xx bytes)	IDX	4 bytes without sign. Is used specially for addressing parameters.
I8	1 byte, with sign																								
I16	2 bytes with sign																								
I32	4 bytes with sign																								
I64	8 bytes with sign																								
U8	1 byte without sign																								
U16	2 bytes without sign																								
U32	4 bytes without sign																								
U64	8 bytes without sign																								
REAL32	4 bytes floating point																								
STRING[xx]	ASCII string (with character length xx)																								
OCTET[xx]	OCTET string (with xx bytes)																								
IDX	4 bytes without sign. Is used specially for addressing parameters.																								
Factor	Factor for data transmission via network, depending on the number of decimal positions: <table border="1"> <tr><td>1</td><td>No decimal positions</td></tr> <tr><td>10</td><td>1 decimal position</td></tr> <tr><td>100</td><td>2 decimal positions</td></tr> <tr><td>1000</td><td>3 decimal positions</td></tr> <tr><td>10000</td><td>4 decimal positions</td></tr> </table>	1	No decimal positions	10	1 decimal position	100	2 decimal positions	1000	3 decimal positions	10000	4 decimal positions														
1	No decimal positions																								
10	1 decimal position																								
100	2 decimal positions																								
1000	3 decimal positions																								
10000	4 decimal positions																								
A	Attributes (combinations of several attributes also possible): <table border="1"> <tr><td>C</td><td>Setting can only be changed if the inverter is inhibited.</td></tr> <tr><td>E</td><td>Value is displayed as IP address on the keypad.</td></tr> <tr><td>H</td><td>Value is displayed as hexadecimal value on the keypad.</td></tr> <tr><td>I</td><td>Parameter is not displayed.</td></tr> <tr><td>K</td><td>Parameter is only displayed on the keypad.</td></tr> <tr><td>O</td><td>Parameter can be recorded with the oscilloscope function.</td></tr> <tr><td>P</td><td>Setting is saved in the memory module.</td></tr> <tr><td>X</td><td>Parameter is not displayed in the engineering tools.</td></tr> </table>	C	Setting can only be changed if the inverter is inhibited.	E	Value is displayed as IP address on the keypad.	H	Value is displayed as hexadecimal value on the keypad.	I	Parameter is not displayed.	K	Parameter is only displayed on the keypad.	O	Parameter can be recorded with the oscilloscope function.	P	Setting is saved in the memory module.	X	Parameter is not displayed in the engineering tools.								
C	Setting can only be changed if the inverter is inhibited.																								
E	Value is displayed as IP address on the keypad.																								
H	Value is displayed as hexadecimal value on the keypad.																								
I	Parameter is not displayed.																								
K	Parameter is only displayed on the keypad.																								
O	Parameter can be recorded with the oscilloscope function.																								
P	Setting is saved in the memory module.																								
X	Parameter is not displayed in the engineering tools.																								
M	Mapping: <table border="1"> <tr><td>r</td><td>Receive mapping permissible.</td></tr> <tr><td>t</td><td>Transmit mapping permissible.</td></tr> <tr><td>rt</td><td>Receive and transmit mapping permissible.</td></tr> <tr><td>-</td><td>Mapping not permissible.</td></tr> </table>	r	Receive mapping permissible.	t	Transmit mapping permissible.	rt	Receive and transmit mapping permissible.	-	Mapping not permissible.																
r	Receive mapping permissible.																								
t	Transmit mapping permissible.																								
rt	Receive and transmit mapping permissible.																								
-	Mapping not permissible.																								

Parameter attribute list (short overview of all parameter indexes)

Address	Name	Default setting	Category	Data type	Factor	A	M
0x1000	Device type	- (Read only)	CANopen	U32	1	H	-
0x1000	Device type	- (Read only)	EtherCAT	U32	1	X	-
0x1001	Error register	- (Read only)	CANopen	U8	1	H	t
0x1005	COB-ID SYNC	0x00000080	CANopen	U32	1	PH	-
0x1006	Communication cyclic period	0 us	CANopen	U32	1	P	-
0x1008	Manufacturer device name	- (Read only)	CANopen	STRING[50]	1	-	-
0x1008	Manufacturer device name	- (Read only)	EtherCAT	STRING[50]	1	X	-

* Default setting depending on the size.

Firmware version 04.00.00.00

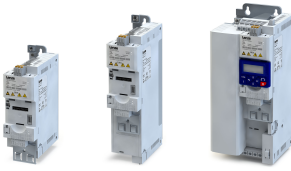

Appendix

Parameter attribute list

Address	Name	Default setting	Category	Data type	Factor	A	M
0x1009	Manufacturer hardware version	- (Read only)	CANopen	STRING[50]	1	-	-
0x1009	Manufacturer hardware version	- (Read only)	EtherCAT	STRING[50]	1	X	-
0x100A	Manufacturer software version	- (Read only)	CANopen	STRING[50]	1	-	-
0x100A	Manufacturer software version	- (Read only)	EtherCAT	STRING[50]	1	X	-
0x1014	COB-ID EMCY	- (Read only)	CANopen	U32	1	H	-
0x1015	Inhibit time EMCY	0.0 ms	CANopen	U16	10	P	-
0x1016:000 (P520.00)	Consumer heartbeat time: Highest sub-index supported	- (Read only)	CANopen	U8	1	-	-
0x1016:001 (P520.01)	Consumer heartbeat time: Consumer heartbeat time 1	0x00000000	CANopen	U32	1	PH	-
0x1016:002 (P520.02)	Consumer heartbeat time: Consumer heartbeat time 2	0x00000000	CANopen	U32	1	PH	-
0x1016:003 (P520.03)	Consumer heartbeat time: Consumer heartbeat time 3	0x00000000	CANopen	U32	1	PH	-
0x1016:004 (P520.04)	Consumer heartbeat time: Consumer heartbeat time 4	0x00000000	CANopen	U32	1	PH	-
0x1017 (P522.00)	Producer heartbeat time	0 ms	CANopen	U16	1	P	-
0x1018:001	Identity object: Vendor ID	- (Read only)	CANopen	U32	1	-	-
0x1018:001	Identity object: Vendor ID	- (Read only)	EtherCAT	U32	1	X	-
0x1018:002	Identity object: Product code	- (Read only)	CANopen	U32	1	H	-
0x1018:002	Identity object: Product code	- (Read only)	EtherCAT	U32	1	X	-
0x1018:003	Identity object: Revision number	- (Read only)	CANopen	U32	1	-	-
0x1018:003	Identity object: Revision number	- (Read only)	EtherCAT	U32	1	X	-
0x1018:004	Identity object: Serial number	- (Read only)	CANopen	U32	1	-	-
0x1018:004	Identity object: Serial number	- (Read only)	EtherCAT	U32	1	X	-
0x1029:000	Error behavior: Highest sub-index supported	- (Read only)	CANopen	U8	1	-	-
0x1029:001	Error behavior: Communication error	Status -> Pre-operational [0]	CANopen	U8	1	P	-
0x1200:000	SDO1 server parameter: Highest sub-index supported	- (Read only)	CANopen	U8	1	-	-
0x1200:001	SDO1 server parameter: COB-ID client -> server (rx)	- (Read only)	CANopen	U32	1	H	-
0x1200:002	SDO1 server parameter: COB-ID server -> client (tx)	- (Read only)	CANopen	U32	1	H	-
0x1201:000	SDO2 server parameter: Highest sub-index supported	- (Read only)	CANopen	U8	1	-	-
0x1201:001	SDO2 server parameter: COB-ID client -> server (rx)	0x80000640	CANopen	U32	1	PH	-
0x1201:002	SDO2 server parameter: COB-ID server -> client (tx)	0x800005C0	CANopen	U32	1	PH	-
0x1201:003	SDO2 server parameter: Node-ID of the SDO client	0	CANopen	U8	1	P	-
0x1400:000	RPDO1 communication parameter: Highest sub-index supported	- (Read only)	CANopen	U8	1	-	-
0x1400:001 (P540.01)	RPDO1 communication parameter: COB-ID	0x00000200	CANopen	U32	1	PH	-
0x1400:002 (P540.02)	RPDO1 communication parameter: Transmission type	255	CANopen	U8	1	P	-
0x1400:005 (P540.05)	RPDO1 communication parameter: Event timer	100 ms	CANopen	U16	1	P	-
0x1401:001 (P541.01)	RPDO2 communication parameter: COB-ID	0x80000300	CANopen	U32	1	PH	-
0x1401:002 (P541.02)	RPDO2 communication parameter: Transmission type	255	CANopen	U8	1	P	-
0x1401:005 (P541.05)	RPDO2 communication parameter: Event timer	100 ms	CANopen	U16	1	P	-

* Default setting depending on the size.

Firmware version 04.00.00.00

Appendix

Parameter attribute list



Address	Name	Default setting	Category	Data type	Factor	A	M
0x1402:001 (P542.01)	RPDO3 communication parameter: COB-ID	0x80000400	CANopen	U32	1	PH	-
0x1402:002 (P542.02)	RPDO3 communication parameter: Transmission type	255	CANopen	U8	1	P	-
0x1402:005 (P542.05)	RPDO3 communication parameter: Event timer	100 ms	CANopen	U16	1	P	-
0x1600:000	RPDO1 mapping parameter: Number of mapped application objects in PDO	2	CANopen	U8	1	P	-
0x1600:001	RPDO1 mapping parameter: Application object 1	0x60400010	CANopen	U32	1	PH	-
0x1600:002	RPDO1 mapping parameter: Application object 2	0x60420010	CANopen	U32	1	PH	-
0x1600:003	RPDO1 mapping parameter: Application object 3	0x00000000	CANopen	U32	1	PH	-
0x1600:004	RPDO1 mapping parameter: Application object 4	0x00000000	CANopen	U32	1	PH	-
0x1600:005	RPDO1 mapping parameter: Application object 5	0x00000000	CANopen	U32	1	PH	-
0x1600:006	RPDO1 mapping parameter: Application object 6	0x00000000	CANopen	U32	1	PH	-
0x1600:007	RPDO1 mapping parameter: Application object 7	0x00000000	CANopen	U32	1	PH	-
0x1600:008	RPDO1 mapping parameter: Application object 8	0x00000000	CANopen	U32	1	PH	-
0x1601:000	RPDO2 mapping parameter: Number of mapped application objects in PDO	0	CANopen	U8	1	P	-
0x1601:001	RPDO2 mapping parameter: Application object 1	0x00000000	CANopen	U32	1	PH	-
0x1601:002	RPDO2 mapping parameter: Application object 2	0x00000000	CANopen	U32	1	PH	-
0x1601:003	RPDO2 mapping parameter: Application object 3	0x00000000	CANopen	U32	1	PH	-
0x1601:004	RPDO2 mapping parameter: Application object 4	0x00000000	CANopen	U32	1	PH	-
0x1601:005	RPDO2 mapping parameter: Application object 5	0x00000000	CANopen	U32	1	PH	-
0x1601:006	RPDO2 mapping parameter: Application object 6	0x00000000	CANopen	U32	1	PH	-
0x1601:007	RPDO2 mapping parameter: Application object 7	0x00000000	CANopen	U32	1	PH	-
0x1601:008	RPDO2 mapping parameter: Application object 8	0x00000000	CANopen	U32	1	PH	-
0x1602:000	RPDO3 mapping parameter: Number of mapped application objects in PDO	0	CANopen	U8	1	P	-
0x1602:001	RPDO3 mapping parameter: Application object 1	0x00000000	CANopen	U32	1	PH	-
0x1602:002	RPDO3 mapping parameter: Application object 2	0x00000000	CANopen	U32	1	PH	-
0x1602:003	RPDO3 mapping parameter: Application object 3	0x00000000	CANopen	U32	1	PH	-
0x1602:004	RPDO3 mapping parameter: Application object 4	0x00000000	CANopen	U32	1	PH	-
0x1602:005	RPDO3 mapping parameter: Application object 5	0x00000000	CANopen	U32	1	PH	-
0x1602:006	RPDO3 mapping parameter: Application object 6	0x00000000	CANopen	U32	1	PH	-
0x1602:007	RPDO3 mapping parameter: Application object 7	0x00000000	CANopen	U32	1	PH	-
0x1602:008	RPDO3 mapping parameter: Application object 8	0x00000000	CANopen	U32	1	PH	-
0x1603:001	RPDO4 mapping parameter: Application object 1	-(Read only)	EtherCAT	U32	1	XH	-
0x1603:002	RPDO4 mapping parameter: Application object 2	-(Read only)	EtherCAT	U32	1	XH	-
0x1605:001	RPDO6 mapping parameter: Application object 1	-(Read only)	EtherCAT	U32	1	XH	-
0x1605:002	RPDO6 mapping parameter: Application object 2	-(Read only)	EtherCAT	U32	1	XH	-
0x1605:003	RPDO6 mapping parameter: Application object 3	-(Read only)	EtherCAT	U32	1	XH	-
0x1605:004	RPDO6 mapping parameter: Application object 4	-(Read only)	EtherCAT	U32	1	XH	-
0x1605:005	RPDO6 mapping parameter: Application object 5	-(Read only)	EtherCAT	U32	1	XH	-
0x1605:006	RPDO6 mapping parameter: Application object 6	-(Read only)	EtherCAT	U32	1	XH	-
0x1605:007	RPDO6 mapping parameter: Application object 7	-(Read only)	EtherCAT	U32	1	XH	-
0x1605:008	RPDO6 mapping parameter: Application object 8	-(Read only)	EtherCAT	U32	1	XH	-
0x1605:009	RPDO6 mapping parameter: Application object 9	-(Read only)	EtherCAT	U32	1	XH	-
0x1605:010	RPDO6 mapping parameter: Application object 10	-(Read only)	EtherCAT	U32	1	XH	-
0x1605:011	RPDO6 mapping parameter: Application object 11	-(Read only)	EtherCAT	U32	1	XH	-
0x1605:012	RPDO6 mapping parameter: Application object 12	-(Read only)	EtherCAT	U32	1	XH	-
0x1605:013	RPDO6 mapping parameter: Application object 13	-(Read only)	EtherCAT	U32	1	XH	-

* Default setting depending on the size.

Firmware version 04.00.00.00



Appendix

Parameter attribute list

Address	Name	Default setting	Category	Data type	Factor	A	M
0x1605:014	RPDO6 mapping parameter: Application object 14	- (Read only)	EtherCAT	U32	1	XH	-
0x1605:015	RPDO6 mapping parameter: Application object 15	- (Read only)	EtherCAT	U32	1	XH	-
0x1605:016	RPDO6 mapping parameter: Application object 16	- (Read only)	EtherCAT	U32	1	XH	-
0x1800:000	TPDO1 communication parameter: Highest sub-index supported	- (Read only)	CANopen	U8	1	-	-
0x1800:001 (P550.01)	TPDO1 communication parameter: COB-ID	0x40000180	CANopen	U32	1	PH	-
0x1800:002 (P550.02)	TPDO1 communication parameter: Transmission type	255	CANopen	U8	1	P	-
0x1800:003 (P550.03)	TPDO1 communication parameter: Inhibit time	0.0 ms	CANopen	U16	10	P	-
0x1800:005 (P550.05)	TPDO1 communication parameter: Event timer	20 ms	CANopen	U16	1	P	-
0x1801:000	TPDO2 communication parameter: Highest sub-index supported	- (Read only)	CANopen	U8	1	-	-
0x1801:001 (P551.01)	TPDO2 communication parameter: COB-ID	0xC0000280	CANopen	U32	1	PH	-
0x1801:002 (P551.02)	TPDO2 communication parameter: Transmission type	255	CANopen	U8	1	P	-
0x1801:003 (P551.03)	TPDO2 communication parameter: Inhibit time	0.0 ms	CANopen	U16	10	P	-
0x1801:005 (P551.05)	TPDO2 communication parameter: Event timer	0 ms	CANopen	U16	1	P	-
0x1802:000	TPDO3 communication parameter: Highest sub-index supported	- (Read only)	CANopen	U8	1	-	-
0x1802:001 (P552.01)	TPDO3 communication parameter: COB-ID	0xC0000380	CANopen	U32	1	PH	-
0x1802:002 (P552.02)	TPDO3 communication parameter: Transmission type	255	CANopen	U8	1	P	-
0x1802:003 (P552.03)	TPDO3 communication parameter: Inhibit time	0.0 ms	CANopen	U16	10	P	-
0x1802:005 (P552.05)	TPDO3 communication parameter: Event timer	0 ms	CANopen	U16	1	P	-
0x1A00:000	TPDO1 mapping parameter: Number of mapped application objects in TPDO	2	CANopen	U8	1	P	-
0x1A00:001	TPDO1 mapping parameter: Application object 1	0x60410010	CANopen	U32	1	PH	-
0x1A00:002	TPDO1 mapping parameter: Application object 2	0x60440010	CANopen	U32	1	PH	-
0x1A00:003	TPDO1 mapping parameter: Application object 3	0x00000000	CANopen	U32	1	PH	-
0x1A00:004	TPDO1 mapping parameter: Application object 4	0x00000000	CANopen	U32	1	PH	-
0x1A00:005	TPDO1 mapping parameter: Application object 5	0x00000000	CANopen	U32	1	PH	-
0x1A00:006	TPDO1 mapping parameter: Application object 6	0x00000000	CANopen	U32	1	PH	-
0x1A00:007	TPDO1 mapping parameter: Application object 7	0x00000000	CANopen	U32	1	PH	-
0x1A00:008	TPDO1 mapping parameter: Application object 8	0x00000000	CANopen	U32	1	PH	-
0x1A01:000	TPDO2 mapping parameter: Number of mapped application objects in TPDO	0	CANopen	U8	1	P	-
0x1A01:001	TPDO2 mapping parameter: Application object 1	0x00000000	CANopen	U32	1	PH	-
0x1A01:002	TPDO2 mapping parameter: Application object 2	0x00000000	CANopen	U32	1	PH	-
0x1A01:003	TPDO2 mapping parameter: Application object 3	0x00000000	CANopen	U32	1	PH	-
0x1A01:004	TPDO2 mapping parameter: Application object 4	0x00000000	CANopen	U32	1	PH	-
0x1A01:005	TPDO2 mapping parameter: Application object 5	0x00000000	CANopen	U32	1	PH	-
0x1A01:006	TPDO2 mapping parameter: Application object 6	0x00000000	CANopen	U32	1	PH	-
0x1A01:007	TPDO2 mapping parameter: Application object 7	0x00000000	CANopen	U32	1	PH	-
0x1A01:008	TPDO2 mapping parameter: Application object 8	0x00000000	CANopen	U32	1	PH	-
0x1A02:000	TPDO3 mapping parameter: Number of mapped application objects in TPDO	0	CANopen	U8	1	P	-

* Default setting depending on the size.

Firmware version 04.00.00.00

Appendix

Parameter attribute list



Address	Name	Default setting	Category	Data type	Factor	A	M
0x1A02:001	TPDO3 mapping parameter: Application object 1	0x00000000	CANopen	U32	1	PH	-
0x1A02:002	TPDO3 mapping parameter: Application object 2	0x00000000	CANopen	U32	1	PH	-
0x1A02:003	TPDO3 mapping parameter: Application object 3	0x00000000	CANopen	U32	1	PH	-
0x1A02:004	TPDO3 mapping parameter: Application object 4	0x00000000	CANopen	U32	1	PH	-
0x1A02:005	TPDO3 mapping parameter: Application object 5	0x00000000	CANopen	U32	1	PH	-
0x1A02:006	TPDO3 mapping parameter: Application object 6	0x00000000	CANopen	U32	1	PH	-
0x1A02:007	TPDO3 mapping parameter: Application object 7	0x00000000	CANopen	U32	1	PH	-
0x1A02:008	TPDO3 mapping parameter: Application object 8	0x00000000	CANopen	U32	1	PH	-
0x1A03:001	TPDO4 mapping parameter: Application object 1	- (Read only)	EtherCAT	U32	1	XH	-
0x1A03:002	TPDO4 mapping parameter: Application object 2	- (Read only)	EtherCAT	U32	1	XH	-
0x1A03:003	TPDO4 mapping parameter: Application object 3	- (Read only)	EtherCAT	U32	1	XH	-
0x1A05:001	TPDO6 mapping parameter: Application object 1	- (Read only)	EtherCAT	U32	1	XH	-
0x1A05:002	TPDO6 mapping parameter: Application object 2	- (Read only)	EtherCAT	U32	1	XH	-
0x1A05:003	TPDO6 mapping parameter: Application object 3	- (Read only)	EtherCAT	U32	1	XH	-
0x1A05:004	TPDO6 mapping parameter: Application object 4	- (Read only)	EtherCAT	U32	1	XH	-
0x1A05:005	TPDO6 mapping parameter: Application object 5	- (Read only)	EtherCAT	U32	1	XH	-
0x1A05:006	TPDO6 mapping parameter: Application object 6	- (Read only)	EtherCAT	U32	1	XH	-
0x1A05:007	TPDO6 mapping parameter: Application object 7	- (Read only)	EtherCAT	U32	1	XH	-
0x1A05:008	TPDO6 mapping parameter: Application object 8	- (Read only)	EtherCAT	U32	1	XH	-
0x1A05:009	TPDO6 mapping parameter: Application object 9	- (Read only)	EtherCAT	U32	1	XH	-
0x1A05:010	TPDO6 mapping parameter: Application object 10	- (Read only)	EtherCAT	U32	1	XH	-
0x1A05:011	TPDO6 mapping parameter: Application object 11	- (Read only)	EtherCAT	U32	1	XH	-
0x1A05:012	TPDO6 mapping parameter: Application object 12	- (Read only)	EtherCAT	U32	1	XH	-
0x1A05:013	TPDO6 mapping parameter: Application object 13	- (Read only)	EtherCAT	U32	1	XH	-
0x1A05:014	TPDO6 mapping parameter: Application object 14	- (Read only)	EtherCAT	U32	1	XH	-
0x1A05:015	TPDO6 mapping parameter: Application object 15	- (Read only)	EtherCAT	U32	1	XH	-
0x1A05:016	TPDO6 mapping parameter: Application object 16	- (Read only)	EtherCAT	U32	1	XH	-
0x1C00:001	Sync Manager communication type: SM1 communication type	- (Read only)	EtherCAT	U8	1	X	-
0x1C00:002	Sync Manager communication type: SM2 communication type	- (Read only)	EtherCAT	U8	1	X	-
0x1C00:003	Sync Manager communication type: SM3 communication type	- (Read only)	EtherCAT	U8	1	X	-
0x1C00:004	Sync Manager communication type: SM4 communication type	- (Read only)	EtherCAT	U8	1	X	-
0x1C12:000	Number of assigned PDOs	- (Read only)	EtherCAT	U8	1	X	-
0x1C12:001	PDO mapping object index of assigned RxPDO 1	- (Read only)	EtherCAT	U16	1	XH	-
0x1C12:002	PDO mapping object index of assigned RxPDO 2	- (Read only)	EtherCAT	U16	1	XH	-
0x1C13:000	Number of assigned PDOs	- (Read only)	EtherCAT	U8	1	X	-
0x1C13:001	PDO mapping object index of assigned RxPDO 1	- (Read only)	EtherCAT	U16	1	XH	-
0x1C13:002	PDO mapping object index of assigned RxPDO 2	- (Read only)	EtherCAT	U16	1	XH	-
0x1C32:001	Sync Manager 2: Synchronization type	Free run [0]	EtherCAT	U16	1	X	-
0x1C32:002	Sync Manager 2: Cycle time	x ns (Read only)	EtherCAT	U32	1	X	-
0x1C32:003	Sync Manager 2: Shift time	x ns (Read only)	EtherCAT	U32	1	X	-
0x1C32:004	Sync Manager 2: Synchronization types supported	- (Read only)	EtherCAT	U16	1	X	-
0x1C32:005	Sync Manager 2: Minimum cycle time	x ns (Read only)	EtherCAT	U32	1	X	-
0x1C33:001	Sync Manager 3: Synchronization type	0	EtherCAT	U16	1	X	-
0x1C33:002	Sync Manager 3: Cycle time	x ns (Read only)	EtherCAT	U32	1	X	-

* Default setting depending on the size.

Firmware version 04.00.00.00

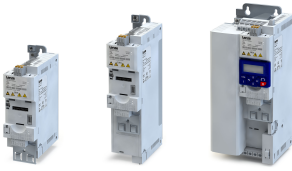

Appendix

Parameter attribute list

Address	Name	Default setting	Category	Data type	Factor	A	M
0x1C33:003	Sync Manager 3: Shift time	x ns (Read only)	EtherCAT	U32	1	X	-
0x1C33:004	Sync Manager 3: Synchronization types supported	- (Read only)	EtherCAT	U16	1	X	-
0x1C33:005	Sync Manager 3: Minimum cycle time	x ns (Read only)	EtherCAT	U32	1	X	-
0x2000:001 (P190.01)	Device data: Product code	- (Read only)	general	STRING[18]	1	-	-
0x2000:002 (P190.02)	Device data: Serial number	- (Read only)	general	STRING[50]	1	-	-
0x2000:004 (P190.04)	Device data: CU firmware version	- (Read only)	general	STRING[50]	1	-	-
0x2000:005 (P190.05)	Device data: CU firmware type	- (Read only)	general	STRING[50]	1	-	-
0x2000:006 (P190.06)	Device data: CU bootloader version	- (Read only)	general	STRING[50]	1	-	-
0x2000:007 (P190.07)	Device data: CU bootloader type	- (Read only)	general	STRING[50]	1	-	-
0x2000:008 (P190.08)	Device data: Object directory version	- (Read only)	general	U32	1	-	-
0x2000:010 (P190.10)	Device data: PU firmware version	- (Read only)	general	STRING[50]	1	-	-
0x2000:011 (P190.11)	Device data: PU firmware type	- (Read only)	general	STRING[50]	1	-	-
0x2000:012 (P190.12)	Device data: PU bootloader version	- (Read only)	general	STRING[50]	1	-	-
0x2000:013 (P190.13)	Device data: PU bootloader type	- (Read only)	general	STRING[50]	1	-	-
0x2000:014 (P190.14)	Device data: Module - firmware version	- (Read only)	general	STRING[11]	1	-	-
0x2001 (P191.00)	Device name	My Device	general	STRING[128]	1	PK	-
0x2002:004 (P192.04)	Device module: CU type code	- (Read only)	general	STRING[19]	1	-	-
0x2002:005 (P192.05)	Device module: PU type code	- (Read only)	general	STRING[19]	1	-	-
0x2002:006 (P192.06)	Device module: CU serial number	- (Read only)	general	STRING[23]	1	-	-
0x2002:007 (P192.07)	Device module: PU serial number	- (Read only)	general	STRING[23]	1	-	-
0x2006:000 (P155.00)	Error history buffer: Keypad display	- (Read only)	general	U8	1	-	-
0x2006:001	Error history buffer: Maximum number of messages	- (Read only)	general	U8	1	-	-
0x2006:002	Error history buffer: Latest message	- (Read only)	general	U8	1	-	-
0x2006:003	Error history buffer: Latest acknowledgement message	0	general	U8	1	-	-
0x2006:004	Error history buffer: New message	- (Read only)	general	U8	1	-	t
0x2006:005	Error history buffer: Buffer overflow	1	general	U16	1	-	-
0x2006:006	Error history buffer: Message 0	- (Read only)	general	OCTET[19]	1	-	-
0x2006:007	Error history buffer: Message 1	- (Read only)	general	OCTET[19]	1	-	-
0x2006:008	Error history buffer: Message 2	- (Read only)	general	OCTET[19]	1	-	-
0x2006:009	Error history buffer: Message 3	- (Read only)	general	OCTET[19]	1	-	-
0x2006:010	Error history buffer: Message 4	- (Read only)	general	OCTET[19]	1	-	-
0x2006:011	Error history buffer: Message 5	- (Read only)	general	OCTET[19]	1	-	-
0x2006:012	Error history buffer: Message 6	- (Read only)	general	OCTET[19]	1	-	-
0x2006:013	Error history buffer: Message 7	- (Read only)	general	OCTET[19]	1	-	-
0x2006:014	Error history buffer: Message 8	- (Read only)	general	OCTET[19]	1	-	-
0x2006:015	Error history buffer: Message 9	- (Read only)	general	OCTET[19]	1	-	-
0x2006:016	Error history buffer: Message 10	- (Read only)	general	OCTET[19]	1	-	-

* Default setting depending on the size.

Firmware version 04.00.00.00

Appendix

Parameter attribute list



Address	Name	Default setting	Category	Data type	Factor	A	M
0x2006:017	Error history buffer: Message 11	- (Read only)	general	OCTET[19]	1	-	-
0x2006:018	Error history buffer: Message 12	- (Read only)	general	OCTET[19]	1	-	-
0x2006:019	Error history buffer: Message 13	- (Read only)	general	OCTET[19]	1	-	-
0x2006:020	Error history buffer: Message 14	- (Read only)	general	OCTET[19]	1	-	-
0x2006:021	Error history buffer: Message 15	- (Read only)	general	OCTET[19]	1	-	-
0x2006:022	Error history buffer: Message 16	- (Read only)	general	OCTET[19]	1	-	-
0x2006:023	Error history buffer: Message 17	- (Read only)	general	OCTET[19]	1	-	-
0x2006:024	Error history buffer: Message 18	- (Read only)	general	OCTET[19]	1	-	-
0x2006:025	Error history buffer: Message 19	- (Read only)	general	OCTET[19]	1	-	-
0x2006:026	Error history buffer: Message 20	- (Read only)	general	OCTET[19]	1	-	-
0x2006:027	Error history buffer: Message 21	- (Read only)	general	OCTET[19]	1	-	-
0x2006:028	Error history buffer: Message 22	- (Read only)	general	OCTET[19]	1	-	-
0x2006:029	Error history buffer: Message 23	- (Read only)	general	OCTET[19]	1	-	-
0x2006:030	Error history buffer: Message 24	- (Read only)	general	OCTET[19]	1	-	-
0x2006:031	Error history buffer: Message 25	- (Read only)	general	OCTET[19]	1	-	-
0x2006:032	Error history buffer: Message 26	- (Read only)	general	OCTET[19]	1	-	-
0x2006:033	Error history buffer: Message 27	- (Read only)	general	OCTET[19]	1	-	-
0x2006:034	Error history buffer: Message 28	- (Read only)	general	OCTET[19]	1	-	-
0x2006:035	Error history buffer: Message 29	- (Read only)	general	OCTET[19]	1	-	-
0x2006:036	Error history buffer: Message 30	- (Read only)	general	OCTET[19]	1	-	-
0x2006:037	Error history buffer: Message 31	- (Read only)	general	OCTET[19]	1	-	-
0x2021:001 (P230.01)	Optical tracking: Start detection	Stop [0]	general	U8	1	-	-
0x2021:002 (P230.02)	Optical tracking: Blinking duration	5 s	general	U16	1	-	-
0x2022:001 (P700.01)	Device commands: Load default settings	Off / ready [0]	general	U8	1	C	-
0x2022:003 (P700.03)	Device commands: Save user data	Off / ready [0]	general	U8	1	-	-
0x2022:004 (P700.04)	Device commands: Load user data	Off / ready [0]	general	U8	1	C	-
0x2022:005 (P700.05)	Device commands: Load OEM data	Off / ready [0]	general	U8	1	C	-
0x2022:006 (P700.06)	Device commands: Save OEM data	Off / ready [0]	general	U8	1	-	-
0x2022:007 (P700.07)	Device commands: Load parameter set 1	Off / ready [0]	general	U8	1	-	-
0x2022:008 (P700.08)	Device commands: Load parameter set 2	Off / ready [0]	general	U8	1	-	-
0x2022:009 (P700.09)	Device commands: Load parameter set 3	Off / ready [0]	general	U8	1	-	-
0x2022:010 (P700.10)	Device commands: Load parameter set 4	Off / ready [0]	general	U8	1	-	-
0x2022:011 (P700.11)	Device commands: Save parameter set 1	Off / ready [0]	general	U8	1	-	-
0x2022:012 (P700.12)	Device commands: Save parameter set 2	Off / ready [0]	general	U8	1	-	-
0x2022:013 (P700.13)	Device commands: Save parameter set 3	Off / ready [0]	general	U8	1	-	-
0x2022:014 (P700.14)	Device commands: Save parameter set 4	Off / ready [0]	general	U8	1	-	-
0x2022:015 (P700.15)	Device commands: Delete logbook	Off / ready [0]	general	U8	1	C	-
0x2022:032	Device commands: Deactivate PDO Communication	Off / ready [0]	general	U8	1	-	-
0x2022:033	Device commands: Activate PDO Communication	Off / ready [0]	general	U8	1	-	-
0x2030	CRC parameter set	- (Read only)	general	U32	1	-	-
* Default setting depending on the size.				Firmware version 04.00.00.00			



Appendix

Parameter attribute list

Address	Name	Default setting	Category	Data type	Factor	A	M
0x203D (P730.00)	PIN1 access protection	0	general	I16	1	-	-
0x203E (P731.00)	PIN2 access protection	0	general	I16	1	-	-
0x203F	PIN1/PIN2 log-in	0	general	I16	1	-	-
0x2040 (P197.00)	Access protection status	- (Read only)	general	U16	1	-	-
0x2300 (P508.00)	CANopen communication	No action/no error [0]	CANopen	U8	1	C	-
0x2301:001 (P510.01)	CANopen settings: Node ID	1	CANopen	U8	1	P	-
0x2301:002 (P510.02)	CANopen settings: Baud rate	500 kbps [5]	CANopen	U8	1	P	-
0x2301:003 (P510.03)	CANopen settings: Slave/Master	Slave [0]	CANopen	U8	1	P	-
0x2301:004 (P510.04)	CANopen settings: Start remote delay	3000 ms	CANopen	U16	1	P	-
0x2301:005 (P510.05)	CANopen settings: Activate SDO2 channel	Not active [0]	CANopen	U8	1	-	-
0x2301:006 (P510.06)	CANopen settings: COB-ID Configuration	Base + node-ID [0]	CANopen	U8	1	P	-
0x2302:001 (P511.01)	Active CANopen settings: Active node ID	- (Read only)	CANopen	U8	1	-	-
0x2302:002 (P511.02)	Active CANopen settings: Active baud rate	- (Read only)	CANopen	U8	1	-	-
0x2303 (P509.00)	CANopen switch position	- (Read only)	CANopen	U16	1	-	-
0x2307 (P515.00)	CANopen time-out status	- (Read only)	CANopen	U32	1	-	-
0x2308 (P516.00)	CANopen status	- (Read only)	CANopen	U16	1	-	-
0x2309 (P517.00)	CANopen controller status	- (Read only)	CANopen	U16	1	-	-
0x230A:000	CANopen statistics: Highest subindex	- (Read only)	CANopen	U8	1	-	-
0x230A:001 (P580.01)	CANopen statistics: PDO1 received	- (Read only)	CANopen	U16	1	-	-
0x230A:002 (P580.02)	CANopen statistics: PDO2 received	- (Read only)	CANopen	U16	1	-	-
0x230A:003 (P580.03)	CANopen statistics: PDO3 received	- (Read only)	CANopen	U16	1	-	-
0x230A:005 (P580.05)	CANopen statistics: PDO1 transmitted	- (Read only)	CANopen	U16	1	-	-
0x230A:006 (P580.06)	CANopen statistics: PDO2 transmitted	- (Read only)	CANopen	U16	1	-	-
0x230A:007 (P580.07)	CANopen statistics: PDO3 transmitted	- (Read only)	CANopen	U16	1	-	-
0x230A:009 (P580.09)	CANopen statistics: SDO1 telegrams	- (Read only)	CANopen	U16	1	-	-
0x230A:010 (P580.10)	CANopen statistics: SDO2 telegrams	- (Read only)	CANopen	U16	1	-	-
0x230B (P518.00)	CANopen error counter	- (Read only)	CANopen	U16	1	-	-
0x231F:001 (P500.01)	Module ID: Active module ID	- (Read only)	general	U8	1	P	-
0x231F:002 (P500.02)	Module ID: Module ID connected	- (Read only)	general	U8	1	-	-
0x2320 (P508.00)	Modbus communication	No action/no error [0]	Modbus RTU	U8	1	-	-

* Default setting depending on the size.

Firmware version 04.00.00.00

Appendix

Parameter attribute list



Address	Name	Default setting	Category	Data type	Factor	A	M
0x2321:001 (P510.01)	Modbus settings: Node ID	1	Modbus RTU	U8	1	P	-
0x2321:002 (P510.02)	Modbus settings: Baud rate	Automatic [0]	Modbus RTU	U8	1	P	-
0x2321:003 (P510.03)	Modbus settings: Data format	Automatic [0]	Modbus RTU	U8	1	P	-
0x2321:004 (P510.04)	Modbus settings: Minimum response time	0 ms	Modbus RTU	U16	1	P	-
0x2322:001 (P511.01)	Active Modbus settings: Active node ID	- (Read only)	Modbus RTU	U8	1	-	-
0x2322:002 (P511.02)	Active Modbus settings: Active baud rate	- (Read only)	Modbus RTU	U8	1	-	-
0x2322:003 (P511.03)	Active Modbus settings: Data format	- (Read only)	Modbus RTU	U8	1	-	-
0x2323 (P509.00)	Modbus switch position	- (Read only)	Modbus RTU	U16	1	-	-
0x232A:001 (P580.01)	Modbus statistics: Messages received	- (Read only)	Modbus RTU	U32	1	-	-
0x232A:002 (P580.02)	Modbus statistics: Valid messages received	- (Read only)	Modbus RTU	U32	1	-	-
0x232A:003 (P580.03)	Modbus statistics: Messages with exceptions	- (Read only)	Modbus RTU	U32	1	-	-
0x232A:004 (P580.04)	Modbus statistics: Messages with errors	- (Read only)	Modbus RTU	U32	1	-	-
0x232A:005 (P580.05)	Modbus statistics: Messages sent	- (Read only)	Modbus RTU	U32	1	-	-
0x232B:001 (P530.01)	Modbus parameter mapping: Parameter 1	0x00000000	Modbus RTU	IDX	1	PH	-
0x232B:002 (P530.02)	Modbus parameter mapping: Parameter 2	0x00000000	Modbus RTU	IDX	1	PH	-
0x232B:003 (P530.03)	Modbus parameter mapping: Parameter 3	0x00000000	Modbus RTU	IDX	1	PH	-
0x232B:004 (P530.04)	Modbus parameter mapping: Parameter 4	0x00000000	Modbus RTU	IDX	1	PH	-
0x232B:005 (P530.05)	Modbus parameter mapping: Parameter 5	0x00000000	Modbus RTU	IDX	1	PH	-
0x232B:006 (P530.06)	Modbus parameter mapping: Parameter 6	0x00000000	Modbus RTU	IDX	1	PH	-
0x232B:007 (P530.07)	Modbus parameter mapping: Parameter 7	0x00000000	Modbus RTU	IDX	1	PH	-
0x232B:008 (P530.08)	Modbus parameter mapping: Parameter 8	0x00000000	Modbus RTU	IDX	1	PH	-
0x232B:009 (P530.09)	Modbus parameter mapping: Parameter 9	0x00000000	Modbus RTU	IDX	1	PH	-
0x232B:010 (P530.10)	Modbus parameter mapping: Parameter 10	0x00000000	Modbus RTU	IDX	1	PH	-
0x232B:011 (P530.11)	Modbus parameter mapping: Parameter 11	0x00000000	Modbus RTU	IDX	1	PH	-
0x232B:012 (P530.12)	Modbus parameter mapping: Parameter 12	0x00000000	Modbus RTU	IDX	1	PH	-
0x232B:013 (P530.13)	Modbus parameter mapping: Parameter 13	0x00000000	Modbus RTU	IDX	1	PH	-
0x232B:014 (P530.14)	Modbus parameter mapping: Parameter 14	0x00000000	Modbus RTU	IDX	1	PH	-
0x232B:015 (P530.15)	Modbus parameter mapping: Parameter 15	0x00000000	Modbus RTU	IDX	1	PH	-
0x232B:016 (P530.16)	Modbus parameter mapping: Parameter 16	0x00000000	Modbus RTU	IDX	1	PH	-

* Default setting depending on the size.

Firmware version 04.00.00.00



Appendix

Parameter attribute list

Address	Name	Default setting	Category	Data type	Factor	A	M
0x232B:017 (P530.17)	Modbus parameter mapping: Parameter 17	0x00000000	Modbus RTU	IDX	1	PH	-
0x232B:018 (P530.18)	Modbus parameter mapping: Parameter 18	0x00000000	Modbus RTU	IDX	1	PH	-
0x232B:019 (P530.19)	Modbus parameter mapping: Parameter 19	0x00000000	Modbus RTU	IDX	1	PH	-
0x232B:020 (P530.20)	Modbus parameter mapping: Parameter 20	0x00000000	Modbus RTU	IDX	1	PH	-
0x232B:021 (P530.21)	Modbus parameter mapping: Parameter 21	0x00000000	Modbus RTU	IDX	1	PH	-
0x232B:022 (P530.22)	Modbus parameter mapping: Parameter 22	0x00000000	Modbus RTU	IDX	1	PH	-
0x232B:023 (P530.23)	Modbus parameter mapping: Parameter 23	0x00000000	Modbus RTU	IDX	1	PH	-
0x232B:024 (P530.24)	Modbus parameter mapping: Parameter 24	0x00000000	Modbus RTU	IDX	1	PH	-
0x232C:001 (P531.01)	Modbus register assignment: Register 1	- (Read only)	Modbus RTU	U16	1	-	-
0x232C:002 (P531.02)	Modbus register assignment: Register 2	- (Read only)	Modbus RTU	U16	1	-	-
0x232C:003 (P531.03)	Modbus register assignment: Register 3	- (Read only)	Modbus RTU	U16	1	-	-
0x232C:004 (P531.04)	Modbus register assignment: Register 4	- (Read only)	Modbus RTU	U16	1	-	-
0x232C:005 (P531.05)	Modbus register assignment: Register 5	- (Read only)	Modbus RTU	U16	1	-	-
0x232C:006 (P531.06)	Modbus register assignment: Register 6	- (Read only)	Modbus RTU	U16	1	-	-
0x232C:007 (P531.07)	Modbus register assignment: Register 7	- (Read only)	Modbus RTU	U16	1	-	-
0x232C:008 (P531.08)	Modbus register assignment: Register 8	- (Read only)	Modbus RTU	U16	1	-	-
0x232C:009 (P531.09)	Modbus register assignment: Register 9	- (Read only)	Modbus RTU	U16	1	-	-
0x232C:010 (P531.10)	Modbus register assignment: Register 10	- (Read only)	Modbus RTU	U16	1	-	-
0x232C:011 (P531.11)	Modbus register assignment: Register 11	- (Read only)	Modbus RTU	U16	1	-	-
0x232C:012 (P531.12)	Modbus register assignment: Register 12	- (Read only)	Modbus RTU	U16	1	-	-
0x232C:013 (P531.13)	Modbus register assignment: Register 13	- (Read only)	Modbus RTU	U16	1	-	-
0x232C:014 (P531.14)	Modbus register assignment: Register 14	- (Read only)	Modbus RTU	U16	1	-	-
0x232C:015 (P531.15)	Modbus register assignment: Register 15	- (Read only)	Modbus RTU	U16	1	-	-
0x232C:016 (P531.16)	Modbus register assignment: Register 16	- (Read only)	Modbus RTU	U16	1	-	-
0x232C:017 (P531.17)	Modbus register assignment: Register 17	- (Read only)	Modbus RTU	U16	1	-	-
0x232C:018 (P531.18)	Modbus register assignment: Register 18	- (Read only)	Modbus RTU	U16	1	-	-
0x232C:019 (P531.19)	Modbus register assignment: Register 19	- (Read only)	Modbus RTU	U16	1	-	-
0x232C:020 (P531.20)	Modbus register assignment: Register 20	- (Read only)	Modbus RTU	U16	1	-	-
0x232C:021 (P531.21)	Modbus register assignment: Register 21	- (Read only)	Modbus RTU	U16	1	-	-

* Default setting depending on the size.

Firmware version 04.00.00.00

Appendix

Parameter attribute list



Address	Name	Default setting	Category	Data type	Factor	A	M
0x232C:022 (P531.22)	Modbus register assignment: Register 22	- (Read only)	Modbus RTU	U16	1	-	-
0x232C:023 (P531.23)	Modbus register assignment: Register 23	- (Read only)	Modbus RTU	U16	1	-	-
0x232C:024 (P531.24)	Modbus register assignment: Register 24	- (Read only)	Modbus RTU	U16	1	-	-
0x232D (P532.00)	Modbus verification code	- (Read only)	Modbus RTU	U16	1	-	-
0x232E:001 (P583.01)	Modbus diagnostics of last Rx data: Offset	0	Modbus RTU	U8	1	-	-
0x232E:002 (P583.02)	Modbus diagnostics of last Rx data: Data byte 0	- (Read only)	Modbus RTU	U8	1	-	-
0x232E:003 (P583.03)	Modbus diagnostics of last Rx data: Data byte 1	- (Read only)	Modbus RTU	U8	1	-	-
0x232E:004 (P583.04)	Modbus diagnostics of last Rx data: Data byte 2	- (Read only)	Modbus RTU	U8	1	-	-
0x232E:005 (P583.05)	Modbus diagnostics of last Rx data: Data byte 3	- (Read only)	Modbus RTU	U8	1	-	-
0x232E:006 (P583.06)	Modbus diagnostics of last Rx data: Data byte 4	- (Read only)	Modbus RTU	U8	1	-	-
0x232E:007 (P583.07)	Modbus diagnostics of last Rx data: Data byte 5	- (Read only)	Modbus RTU	U8	1	-	-
0x232E:008 (P583.08)	Modbus diagnostics of last Rx data: Data byte 6	- (Read only)	Modbus RTU	U8	1	-	-
0x232E:009 (P583.09)	Modbus diagnostics of last Rx data: Data byte 7	- (Read only)	Modbus RTU	U8	1	-	-
0x232E:010 (P583.10)	Modbus diagnostics of last Rx data: Data byte 8	- (Read only)	Modbus RTU	U8	1	-	-
0x232E:011 (P583.11)	Modbus diagnostics of last Rx data: Data byte 9	- (Read only)	Modbus RTU	U8	1	-	-
0x232E:012 (P583.12)	Modbus diagnostics of last Rx data: Data byte 10	- (Read only)	Modbus RTU	U8	1	-	-
0x232E:013 (P583.13)	Modbus diagnostics of last Rx data: Data byte 11	- (Read only)	Modbus RTU	U8	1	-	-
0x232E:014 (P583.14)	Modbus diagnostics of last Rx data: Data byte 12	- (Read only)	Modbus RTU	U8	1	-	-
0x232E:015 (P583.15)	Modbus diagnostics of last Rx data: Data byte 13	- (Read only)	Modbus RTU	U8	1	-	-
0x232E:016 (P583.16)	Modbus diagnostics of last Rx data: Data byte 14	- (Read only)	Modbus RTU	U8	1	-	-
0x232E:017 (P583.17)	Modbus diagnostics of last Rx data: Data byte 15	- (Read only)	Modbus RTU	U8	1	-	-
0x232F:001 (P585.01)	Modbus diagnostics of last Tx data: Offset	0	Modbus RTU	U8	1	-	-
0x232F:002 (P585.02)	Modbus diagnostics of last Tx data: Data byte 0	- (Read only)	Modbus RTU	U8	1	-	-
0x232F:003 (P585.03)	Modbus diagnostics of last Tx data: Data byte 1	- (Read only)	Modbus RTU	U8	1	-	-
0x232F:004 (P585.04)	Modbus diagnostics of last Tx data: Data byte 2	- (Read only)	Modbus RTU	U8	1	-	-
0x232F:005 (P585.05)	Modbus diagnostics of last Tx data: Data byte 3	- (Read only)	Modbus RTU	U8	1	-	-
0x232F:006 (P585.06)	Modbus diagnostics of last Tx data: Data byte 4	- (Read only)	Modbus RTU	U8	1	-	-
0x232F:007 (P585.07)	Modbus diagnostics of last Tx data: Data byte 5	- (Read only)	Modbus RTU	U8	1	-	-
0x232F:008 (P585.08)	Modbus diagnostics of last Tx data: Data byte 6	- (Read only)	Modbus RTU	U8	1	-	-

* Default setting depending on the size.

Firmware version 04.00.00.00

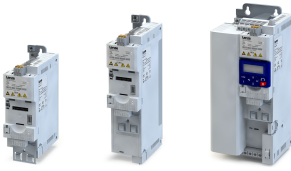

Appendix

Parameter attribute list

Address	Name	Default setting	Category	Data type	Factor	A	M
0x232F:009 (P585.09)	Modbus diagnostics of last Tx data: Data byte 7	- (Read only)	Modbus RTU	U8	1	-	-
0x232F:010 (P585.10)	Modbus diagnostics of last Tx data: Data byte 8	- (Read only)	Modbus RTU	U8	1	-	-
0x232F:011 (P585.11)	Modbus diagnostics of last Tx data: Data byte 9	- (Read only)	Modbus RTU	U8	1	-	-
0x232F:012 (P585.12)	Modbus diagnostics of last Tx data: Data byte 10	- (Read only)	Modbus RTU	U8	1	-	-
0x232F:013 (P585.13)	Modbus diagnostics of last Tx data: Data byte 11	- (Read only)	Modbus RTU	U8	1	-	-
0x232F:014 (P585.14)	Modbus diagnostics of last Tx data: Data byte 12	- (Read only)	Modbus RTU	U8	1	-	-
0x232F:015 (P585.15)	Modbus diagnostics of last Tx data: Data byte 13	- (Read only)	Modbus RTU	U8	1	-	-
0x232F:016 (P585.16)	Modbus diagnostics of last Tx data: Data byte 14	- (Read only)	Modbus RTU	U8	1	-	-
0x232F:017 (P585.17)	Modbus diagnostics of last Tx data: Data byte 15	- (Read only)	Modbus RTU	U8	1	-	-
0x2340	PROFIBUS communication	No action/no error [0]	PROFIBUS	U8	1	-	-
0x2341:001 (P510.01)	PROFIBUS settings: Station address	3	PROFIBUS	U8	1	P	-
0x2342:001 (P511.01)	Active PROFIBUS settings: Active station address	- (Read only)	PROFIBUS	U8	1	-	-
0x2342:002 (P511.02)	Active PROFIBUS settings: Active baud rate	- (Read only)	PROFIBUS	U8	1	-	-
0x2342:003 (P511.03)	Active PROFIBUS settings: Watchdog time	- (Read only)	PROFIBUS	U16	1	-	-
0x2343 (P509.00)	PROFIBUS switch position	- (Read only)	PROFIBUS	U16	1	-	-
0x2344:001 (P512.01)	PROFIBUS Configuration: Extended diagnostic bit	Delete [0]	PROFIBUS	U8	1	P	-
0x2348:001 (P516.01)	PROFIBUS Status: Bus status	- (Read only)	PROFIBUS	U8	1	-	-
0x2348:002 (P516.02)	PROFIBUS Status: Watchdog status	- (Read only)	PROFIBUS	U8	1	-	-
0x2349 (P517.00)	PROFIBUS error	- (Read only)	PROFIBUS	U32	1	-	-
0x234A:001 (P580.01)	PROFIBUS statistics: Data cycles per second	- (Read only)	PROFIBUS	U32	1	-	-
0x234A:002 (P580.02)	PROFIBUS statistics: Parameterization events	- (Read only)	PROFIBUS	U32	1	-	-
0x234A:003 (P580.03)	PROFIBUS statistics: Configuration events	- (Read only)	PROFIBUS	U32	1	-	-
0x234A:004 (P580.04)	PROFIBUS statistics: Diagnostics events	- (Read only)	PROFIBUS	U32	1	-	-
0x234A:005 (P580.05)	PROFIBUS statistics: C1 messages	- (Read only)	PROFIBUS	U32	1	-	-
0x234A:006 (P580.06)	PROFIBUS statistics: C2 messages	- (Read only)	PROFIBUS	U32	1	-	-
0x234A:007 (P580.07)	PROFIBUS statistics: Watchdog events	- (Read only)	PROFIBUS	U32	1	-	-
0x234A:008 (P580.08)	PROFIBUS statistics: Data exchange aborts	- (Read only)	PROFIBUS	U32	1	-	-
0x234A:009 (P580.09)	PROFIBUS statistics: Total data cycles	- (Read only)	PROFIBUS	U32	1	-	-
0x2360 (P508.00)	EtherCAT communication	No action/no error [0]	EtherCAT	U8	1	-	-
0x2361:004 (P510.04)	EtherCAT settings: Device identifier	0	EtherCAT	U16	1	P	-

* Default setting depending on the size.

Firmware version 04.00.00.00

Appendix

Parameter attribute list



Address	Name	Default setting	Category	Data type	Factor	A	M
0x2362:004 (P511.04)	Active EtherCAT settings: Device identifier	- (Read only)	EtherCAT	U16	1	-	-
0x2362:006 (P511.06)	Active EtherCAT settings: Station address	- (Read only)	EtherCAT	U16	1	-	-
0x2362:007 (P511.07)	Active EtherCAT settings: Tx length	- (Read only)	EtherCAT	U16	1	-	-
0x2362:008 (P511.08)	Active EtherCAT settings: Rx length	- (Read only)	EtherCAT	U16	1	-	-
0x2363 (P509.00)	EtherCAT switch position	- (Read only)	EtherCAT	U16	1	-	-
0x2368 (P516.00)	EtherCAT status	- (Read only)	EtherCAT	U16	1	-	-
0x2369 (P517.00)	EtherCAT error	- (Read only)	EtherCAT	U16	1	-	-
0x2380 (P508.00)	PROFINET communication	No action/no error [0]	PROFINET	U8	1	-	-
0x2381:001 (P510.01)	PROFINET settings: IP address	0	PROFINET	U32	1	PE	-
0x2381:002 (P510.02)	PROFINET settings: Subnet	0	PROFINET	U32	1	PE	-
0x2381:003 (P510.03)	PROFINET settings: Gateway	0	PROFINET	U32	1	PE	-
0x2381:004 (P510.04)	PROFINET settings: Station name		PROFINET	STRING[240]	1	P	-
0x2381:005	PROFINET settings: I&M1 System designation		PROFINET	STRING[32]	1	P	-
0x2381:006	PROFINET settings: I&M1 Installation site		PROFINET	STRING[22]	1	P	-
0x2381:007	PROFINET settings: I&M2 Installation date		PROFINET	STRING[16]	1	P	-
0x2381:008	PROFINET settings: I&M3 additional information		PROFINET	STRING[54]	1	P	-
0x2381:009	PROFINET settings: I&M4 signature code		PROFINET	OCTET[54]	1	P	-
0x2382:001 (P511.01)	Active PROFINET settings: IP address	- (Read only)	PROFINET	U32	1	E	-
0x2382:002 (P511.02)	Active PROFINET settings: Subnet	- (Read only)	PROFINET	U32	1	E	-
0x2382:003 (P511.03)	Active PROFINET settings: Gateway	- (Read only)	PROFINET	U32	1	E	-
0x2382:004 (P511.04)	Active PROFINET settings: Station name	- (Read only)	PROFINET	STRING[240]	1	-	-
0x2382:005 (P511.05)	Active PROFINET settings: MAC Address	- (Read only)	PROFINET	OCTET[6]	1	-	-
0x2388 (P516.00)	PROFINET status	- (Read only)	PROFINET	U16	1	-	-
0x2389:001 (P517.01)	PROFINET error: Error 1	- (Read only)	PROFINET	U16	1	-	-
0x2389:002 (P517.02)	PROFINET error: Error 2	- (Read only)	PROFINET	U16	1	-	-
0x23A0 (P508.00)	EtherNet/IP communication	No action/no error [0]	EtherNet/IP	U8	1	-	-
0x23A1:001 (P510.01)	EtherNet/IP settings: IP address	276605120	EtherNet/IP	U32	1	PE	-
0x23A1:002 (P510.02)	EtherNet/IP settings: Subnet	16777215	EtherNet/IP	U32	1	PE	-
0x23A1:003 (P510.03)	EtherNet/IP settings: Gateway	0	EtherNet/IP	U32	1	PE	-
0x23A1:004 (P510.04)	EtherNet/IP settings: Host name		EtherNet/IP	STRING[64]	1	P	-
0x23A1:005 (P510.05)	EtherNet/IP settings: IP configuration	BOOTP [1]	EtherNet/IP	U8	1	P	-
0x23A1:006 (P510.06)	EtherNet/IP settings: Multicast TTL	1	EtherNet/IP	U8	1	P	-

* Default setting depending on the size.

Firmware version 04.00.00.00



Appendix

Parameter attribute list

Address	Name	Default setting	Category	Data type	Factor	A	M
0x23A1:007 (P510.07)	EtherNet/IP settings: Multicast allocation	Default allocation [0]	EtherNet/IP	U8	1	P	-
0x23A1:008 (P510.08)	EtherNet/IP settings: Multicast IP address	3221373167	EtherNet/IP	U32	1	PE	-
0x23A1:009 (P510.09)	EtherNet/IP settings: Multicast number	1	EtherNet/IP	U8	1	P	-
0x23A1:010 (P510.10)	EtherNet/IP settings: Timeout	10000 ms	EtherNet/IP	U16	1	P	-
0x23A2:001 (P511.01)	Active EtherNet/IP settings: IP address	- (Read only)	EtherNet/IP	U32	1	E	-
0x23A2:002 (P511.02)	Active EtherNet/IP settings: Subnet	- (Read only)	EtherNet/IP	U32	1	E	-
0x23A2:003 (P511.03)	Active EtherNet/IP settings: Gateway	- (Read only)	EtherNet/IP	U32	1	E	-
0x23A2:005 (P511.05)	Active EtherNet/IP settings: MAC address	- (Read only)	EtherNet/IP	OCTET[6]	1	-	-
0x23A2:006 (P511.06)	Active EtherNet/IP settings: Multicast address	- (Read only)	EtherNet/IP	U32	1	E	-
0x23A3 (P509.00)	EtherNet/IP switch position	- (Read only)	EtherNet/IP	U8	1	-	-
0x23A4:001 (P512.01)	Port settings: Port 1	Auto-Negotiation [0]	EtherNet/IP	U16	1	P	-
0x23A4:002 (P512.02)	Port settings: Port 2	Auto-Negotiation [0]	EtherNet/IP	U16	1	P	-
0x23A5:001 (P519.01)	Active port settings: Port 1	- (Read only)	EtherNet/IP	U16	1	-	-
0x23A5:002 (P519.02)	Active port settings: Port 2	- (Read only)	EtherNet/IP	U16	1	-	-
0x23A6 (P513.00)	Quality of service	- (Read only)	EtherNet/IP	U8	1	-	-
0x23A7 (P514.00)	Address conflict detection	Enabled [1]	EtherNet/IP	U8	1	P	-
0x23A8 (P516.00)	CIP module status	- (Read only)	EtherNet/IP	U16	1	-	-
0x23A9 (P517.00)	EtherNet/IP status	- (Read only)	EtherNet/IP	U16	1	-	-
0x23B0 (P508.00)	Modbus TCP communication	No action/no error [0]	Modbus TCP/IP	U8	1	-	-
0x23B1:001 (P510.01)	Modbus -TCP/IP settings: IP address	276605120	Modbus TCP/IP	U32	1	PE	-
0x23B1:002 (P510.02)	Modbus -TCP/IP settings: Subnet	16777215	Modbus TCP/IP	U32	1	PE	-
0x23B1:003 (P510.03)	Modbus -TCP/IP settings: Gateway	0	Modbus TCP/IP	U32	1	PE	-
0x23B1:005 (P510.05)	Modbus -TCP/IP settings: IP configuration	Stored IP [0]	Modbus TCP/IP	U8	1	P	-
0x23B1:006 (P510.06)	Modbus -TCP/IP settings: Time-to-live value (TTL)	1	Modbus TCP/IP	U8	1	P	-
0x23B1:010 (P510.10)	Modbus -TCP/IP settings: Ethernet time-out	10000 ms	Modbus TCP/IP	U16	1	P	-
0x23B1:011 (P510.11)	Modbus -TCP/IP settings: Secondary port	502	Modbus TCP/IP	U16	1	P	-
0x23B2:001 (P511.01)	Active Modbus TCP settings: Active IP address	- (Read only)	Modbus TCP/IP	U32	1	E	-
0x23B2:002 (P511.02)	Active Modbus TCP settings: Active subnet	- (Read only)	Modbus TCP/IP	U32	1	E	-
0x23B2:003 (P511.03)	Active Modbus TCP settings: Active gateway	- (Read only)	Modbus TCP/IP	U32	1	E	-

* Default setting depending on the size.

Firmware version 04.00.00.00

Appendix

Parameter attribute list



Address	Name	Default setting	Category	Data type	Factor	A	M
0x23B2:005 (P511.05)	Active Modbus TCP settings: MAC address	- (Read only)	Modbus TCP/IP	OCTET[6]	1	-	-
0x23B3 (P509.00)	Switch position	- (Read only)	Modbus TCP/IP	U8	1	-	-
0x23B4:001 (P512.01)	Port settings: Port 1	Auto-Negotiation [0]	Modbus TCP/IP	U16	1	P	-
0x23B4:002 (P512.02)	Port settings: Port 2	Auto-Negotiation [0]	Modbus TCP/IP	U16	1	P	-
0x23B5:001 (P513.01)	Active port settings: Port 1	- (Read only)	Modbus TCP/IP	U16	1	-	-
0x23B5:002 (P513.02)	Active port settings: Port 2	- (Read only)	Modbus TCP/IP	U16	1	-	-
0x23B6:001 (P514.01)	Time-out monitoring: Time-out time	2.0 s	Modbus TCP/IP	U16	10	P	-
0x23B6:002 (P514.02)	Time-out monitoring: Keep alive time-out time	2.0 s	Modbus TCP/IP	U16	10	P	-
0x23B6:005 (P514.05)	Time-out monitoring: Keep alive register	0	Modbus TCP/IP	U16	1	K	r
0x23B8 (P516.00)	Modbus TCP module status	- (Read only)	Modbus TCP/IP	U16	1	-	-
0x23B9 (P517.00)	Modbus TCP/IP network status	- (Read only)	Modbus TCP/IP	U16	1	-	-
0x23BA:001 (P580.01)	Modbus TCP statistics: Messages received	- (Read only)	Modbus TCP/IP	U32	1	-	-
0x23BA:002 (P580.02)	Modbus TCP statistics: Valid messages received	- (Read only)	Modbus TCP/IP	U32	1	-	-
0x23BA:003 (P580.03)	Modbus TCP statistics: Messages with exceptions	- (Read only)	Modbus TCP/IP	U32	1	-	-
0x23BA:005 (P580.05)	Modbus TCP statistics: Messages sent	- (Read only)	Modbus TCP/IP	U32	1	-	-
0x23BB:001 (P530.01)	Modbus TCP/IP parameter mapping: Parameter 1	0x00000000	Modbus TCP/IP	IDX	1	PH	-
0x23BB:002 (P530.02)	Modbus TCP/IP parameter mapping: Parameter 2	0x00000000	Modbus TCP/IP	IDX	1	PH	-
0x23BB:003 (P530.03)	Modbus TCP/IP parameter mapping: Parameter 3	0x00000000	Modbus TCP/IP	IDX	1	PH	-
0x23BB:004 (P530.04)	Modbus TCP/IP parameter mapping: Parameter 4	0x00000000	Modbus TCP/IP	IDX	1	PH	-
0x23BB:005 (P530.05)	Modbus TCP/IP parameter mapping: Parameter 5	0x00000000	Modbus TCP/IP	IDX	1	PH	-
0x23BB:006 (P530.06)	Modbus TCP/IP parameter mapping: Parameter 6	0x00000000	Modbus TCP/IP	IDX	1	PH	-
0x23BB:007 (P530.07)	Modbus TCP/IP parameter mapping: Parameter 7	0x00000000	Modbus TCP/IP	IDX	1	PH	-
0x23BB:008 (P530.08)	Modbus TCP/IP parameter mapping: Parameter 8	0x00000000	Modbus TCP/IP	IDX	1	PH	-
0x23BB:009 (P530.09)	Modbus TCP/IP parameter mapping: Parameter 9	0x00000000	Modbus TCP/IP	IDX	1	PH	-
0x23BB:010 (P530.10)	Modbus TCP/IP parameter mapping: Parameter 10	0x00000000	Modbus TCP/IP	IDX	1	PH	-
0x23BB:011 (P530.11)	Modbus TCP/IP parameter mapping: Parameter 11	0x00000000	Modbus TCP/IP	IDX	1	PH	-
0x23BB:012 (P530.12)	Modbus TCP/IP parameter mapping: Parameter 12	0x00000000	Modbus TCP/IP	IDX	1	PH	-
0x23BB:013 (P530.13)	Modbus TCP/IP parameter mapping: Parameter 13	0x00000000	Modbus TCP/IP	IDX	1	PH	-
0x23BB:014 (P530.14)	Modbus TCP/IP parameter mapping: Parameter 14	0x00000000	Modbus TCP/IP	IDX	1	PH	-

* Default setting depending on the size.

Firmware version 04.00.00.00

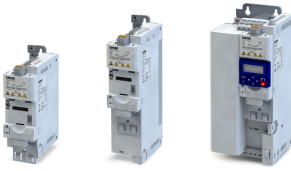

Appendix

Parameter attribute list

Address	Name	Default setting	Category	Data type	Factor	A	M
0x23BB:015 (P530.15)	Modbus TCP/IP parameter mapping: Parameter 15	0x00000000	Modbus TCP/IP	IDX	1	PH	-
0x23BB:016 (P530.16)	Modbus TCP/IP parameter mapping: Parameter 16	0x00000000	Modbus TCP/IP	IDX	1	PH	-
0x23BB:017 (P530.17)	Modbus TCP/IP parameter mapping: Parameter 17	0x00000000	Modbus TCP/IP	IDX	1	PH	-
0x23BB:018 (P530.18)	Modbus TCP/IP parameter mapping: Parameter 18	0x00000000	Modbus TCP/IP	IDX	1	PH	-
0x23BB:019 (P530.19)	Modbus TCP/IP parameter mapping: Parameter 19	0x00000000	Modbus TCP/IP	IDX	1	PH	-
0x23BB:020 (P530.20)	Modbus TCP/IP parameter mapping: Parameter 20	0x00000000	Modbus TCP/IP	IDX	1	PH	-
0x23BB:021 (P530.21)	Modbus TCP/IP parameter mapping: Parameter 21	0x00000000	Modbus TCP/IP	IDX	1	PH	-
0x23BB:022 (P530.22)	Modbus TCP/IP parameter mapping: Parameter 22	0x00000000	Modbus TCP/IP	IDX	1	PH	-
0x23BB:023 (P530.23)	Modbus TCP/IP parameter mapping: Parameter 23	0x00000000	Modbus TCP/IP	IDX	1	PH	-
0x23BB:024 (P530.24)	Modbus TCP/IP parameter mapping: Parameter 24	0x00000000	Modbus TCP/IP	IDX	1	PH	-
0x23BC:001 (P531.01)	Register assignment: Register 1	- (Read only)	Modbus TCP/IP	U16	1	-	-
0x23BC:002 (P531.02)	Register assignment: Register 2	- (Read only)	Modbus TCP/IP	U16	1	-	-
0x23BC:003 (P531.03)	Register assignment: Register 3	- (Read only)	Modbus TCP/IP	U16	1	-	-
0x23BC:004 (P531.04)	Register assignment: Register 4	- (Read only)	Modbus TCP/IP	U16	1	-	-
0x23BC:005 (P531.05)	Register assignment: Register 5	- (Read only)	Modbus TCP/IP	U16	1	-	-
0x23BC:006 (P531.06)	Register assignment: Register 6	- (Read only)	Modbus TCP/IP	U16	1	-	-
0x23BC:007 (P531.07)	Register assignment: Register 7	- (Read only)	Modbus TCP/IP	U16	1	-	-
0x23BC:008 (P531.08)	Register assignment: Register 8	- (Read only)	Modbus TCP/IP	U16	1	-	-
0x23BC:009 (P531.09)	Register assignment: Register 9	- (Read only)	Modbus TCP/IP	U16	1	-	-
0x23BC:010 (P531.10)	Register assignment: Register 10	- (Read only)	Modbus TCP/IP	U16	1	-	-
0x23BC:011 (P531.11)	Register assignment: Register 11	- (Read only)	Modbus TCP/IP	U16	1	-	-
0x23BC:012 (P531.12)	Register assignment: Register 12	- (Read only)	Modbus TCP/IP	U16	1	-	-
0x23BC:013 (P531.13)	Register assignment: Register 13	- (Read only)	Modbus TCP/IP	U16	1	-	-
0x23BC:014 (P531.14)	Register assignment: Register 14	- (Read only)	Modbus TCP/IP	U16	1	-	-
0x23BC:015 (P531.15)	Register assignment: Register 15	- (Read only)	Modbus TCP/IP	U16	1	-	-
0x23BC:016 (P531.16)	Register assignment: Register 16	- (Read only)	Modbus TCP/IP	U16	1	-	-
0x23BC:017 (P531.17)	Register assignment: Register 17	- (Read only)	Modbus TCP/IP	U16	1	-	-
0x23BC:018 (P531.18)	Register assignment: Register 18	- (Read only)	Modbus TCP/IP	U16	1	-	-
0x23BC:019 (P531.19)	Register assignment: Register 19	- (Read only)	Modbus TCP/IP	U16	1	-	-

* Default setting depending on the size.

Firmware version 04.00.00.00

Appendix

Parameter attribute list



Address	Name	Default setting	Category	Data type	Factor	A	M
0x23BC:020 (P531.20)	Register assignment: Register 20	- (Read only)	Modbus TCP/IP	U16	1	-	-
0x23BC:021 (P531.21)	Register assignment: Register 21	- (Read only)	Modbus TCP/IP	U16	1	-	-
0x23BC:022 (P531.22)	Register assignment: Register 22	- (Read only)	Modbus TCP/IP	U16	1	-	-
0x23BC:023 (P531.23)	Register assignment: Register 23	- (Read only)	Modbus TCP/IP	U16	1	-	-
0x23BC:024 (P531.24)	Register assignment: Register 24	- (Read only)	Modbus TCP/IP	U16	1	-	-
0x23BD (P532.00)	Verification code	- (Read only)	Modbus TCP/IP	U16	1	-	-
0x23BE:001 (P585.01)	Modbus TCP/IP diagnostics of last Rx/Tx data: Offset	0	Modbus TCP/IP	U8	1	-	-
0x23BE:002 (P585.02)	Modbus TCP/IP diagnostics of last Rx/Tx data: Last Rx message	- (Read only)	Modbus TCP/IP	OCTET[64]	1	-	-
0x23BE:003 (P585.03)	Modbus TCP/IP diagnostics of last Rx/Tx data: Offset	0	Modbus TCP/IP	U8	1	-	-
0x23BE:004 (P585.04)	Modbus TCP/IP diagnostics of last Rx/Tx data: Last Tx message	- (Read only)	Modbus TCP/IP	OCTET[64]	1	-	-
0x2440	Initiate WLAN	No action/no error [0]	WLAN	U8	1	-	-
0x2441:001	WLAN settings: IP address	28485824	WLAN	U32	1	PE	-
0x2441:002	WLAN settings: Netmask	16777215	WLAN	U32	1	PE	-
0x2441:003	WLAN settings: Gateway	28485824	WLAN	U32	1	PE	-
0x2441:004	WLAN settings: DHCP	Enabled [1]	WLAN	U8	1	P	-
0x2441:005	WLAN settings: DHCP start address	0	WLAN	U32	1	PE	-
0x2441:006	WLAN settings: WLAN operation mode	Access point mode [0]	WLAN	U8	1	P	-
0x2441:007	WLAN settings: WLAN SSID	i5	WLAN	STRING[32]	1	P	-
0x2441:008	WLAN settings: WLAN password	password	WLAN	STRING[64]	1	P	-
0x2441:009	WLAN settings: WLAN security	WPA2 [1]	WLAN	U8	1	P	-
0x2441:010	WLAN settings: WLAN access	Enabled (WLAN on) [1]	WLAN	U8	1	P	-
0x2441:011	WLAN settings: WLAN channel	Channel 1 [1]	WLAN	U8	1	P	-
0x2441:012	WLAN settings: WLAN SSID broadcast	Activated [0]	WLAN	U8	1	P	-
0x2442:001	Active WLAN settings: Active IP address	- (Read only)	WLAN	U32	1	E	-
0x2442:002	Active WLAN settings: Active netmask	- (Read only)	WLAN	U32	1	E	-
0x2442:003	Active WLAN settings: Active gateway	- (Read only)	WLAN	U32	1	E	-
0x2442:004	Active WLAN settings: Active module mode	- (Read only)	WLAN	U8	1	-	-
0x2442:005	Active WLAN settings: MAC address	- (Read only)	WLAN	OCTET[6]	1	-	-
0x2448:001	WLAN status: Connection time	- (Read only)	WLAN	U32	1	-	-
0x2448:002	WLAN status: Number of connections	- (Read only)	WLAN	U16	1	-	-
0x2448:003	WLAN status: Rx frame counter	- (Read only)	WLAN	U16	1	-	-
0x2448:004	WLAN status: Error statistics	- (Read only)	WLAN	U16	1	-	-
0x2449	WLAN error	- (Read only)	WLAN	U16	1	-	-
0x24E0:000	Generic RPDO mapping: Highest subindex	2	Mapping	U8	1	PI	-
0x24E0:001	Generic RPDO mapping: Entry 1	0x60400010	Mapping	U32	1	PH	-
0x24E0:002	Generic RPDO mapping: Entry 2	0x60420010	Mapping	U32	1	PH	-
0x24E0:003	Generic RPDO mapping: Entry 3	0x00000000	Mapping	U32	1	PH	-
0x24E0:004	Generic RPDO mapping: Entry 4	0x00000000	Mapping	U32	1	PH	-
0x24E0:005	Generic RPDO mapping: Entry 5	0x00000000	Mapping	U32	1	PH	-
0x24E0:006	Generic RPDO mapping: Entry 6	0x00000000	Mapping	U32	1	PH	-
0x24E0:007	Generic RPDO mapping: Entry 7	0x00000000	Mapping	U32	1	PH	-
0x24E0:008	Generic RPDO mapping: Entry 8	0x00000000	Mapping	U32	1	PH	-
0x24E0:009	Generic RPDO mapping: Entry 9	0x00000000	Mapping	U32	1	PH	-
0x24E0:010	Generic RPDO mapping: Entry 10	0x00000000	Mapping	U32	1	PH	-
0x24E0:011	Generic RPDO mapping: Entry 11	0x00000000	Mapping	U32	1	PH	-
0x24E0:012	Generic RPDO mapping: Entry 12	0x00000000	Mapping	U32	1	PH	-

* Default setting depending on the size.

Firmware version 04.00.00.00

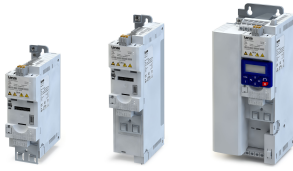

Appendix

Parameter attribute list

Address	Name	Default setting	Category	Data type	Factor	A	M
0x24E0:013	Generic RPDO mapping: Entry 13	0x00000000	Mapping	U32	1	PH	-
0x24E0:014	Generic RPDO mapping: Entry 14	0x00000000	Mapping	U32	1	PH	-
0x24E0:015	Generic RPDO mapping: Entry 15	0x00000000	Mapping	U32	1	PH	-
0x24E0:016	Generic RPDO mapping: Entry 16	0x00000000	Mapping	U32	1	PH	-
0x24E1:000	Generic TPDO mapping: Highest subindex	3	Mapping	U8	1	PI	-
0x24E1:001	Generic TPDO mapping: Entry 1	0x60410010	Mapping	U32	1	PH	-
0x24E1:002	Generic TPDO mapping: Entry 2	0x60440010	Mapping	U32	1	PH	-
0x24E1:003	Generic TPDO mapping: Entry 3	0x603F0010	Mapping	U32	1	PH	-
0x24E1:004	Generic TPDO mapping: Entry 4	0x00000000	Mapping	U32	1	PH	-
0x24E1:005	Generic TPDO mapping: Entry 5	0x00000000	Mapping	U32	1	PH	-
0x24E1:006	Generic TPDO mapping: Entry 6	0x00000000	Mapping	U32	1	PH	-
0x24E1:007	Generic TPDO mapping: Entry 7	0x00000000	Mapping	U32	1	PH	-
0x24E1:008	Generic TPDO mapping: Entry 8	0x00000000	Mapping	U32	1	PH	-
0x24E1:009	Generic TPDO mapping: Entry 9	0x00000000	Mapping	U32	1	PH	-
0x24E1:010	Generic TPDO mapping: Entry 10	0x00000000	Mapping	U32	1	PH	-
0x24E1:011	Generic TPDO mapping: Entry 11	0x00000000	Mapping	U32	1	PH	-
0x24E1:012	Generic TPDO mapping: Entry 12	0x00000000	Mapping	U32	1	PH	-
0x24E1:013	Generic TPDO mapping: Entry 13	0x00000000	Mapping	U32	1	PH	-
0x24E1:014	Generic TPDO mapping: Entry 14	0x00000000	Mapping	U32	1	PH	-
0x24E1:015	Generic TPDO mapping: Entry 15	0x00000000	Mapping	U32	1	PH	-
0x24E1:016	Generic TPDO mapping: Entry 16	0x00000000	Mapping	U32	1	PH	-
0x2540:001 (P208.01)	Mains settings: Rated mains voltage	230 Veff [0]	general	U8	1	PC	-
0x2540:002 (P208.02)	Mains settings: Undervoltage warning threshold	0 V *	general	U16	1	P	-
0x2540:003 (P208.03)	Mains settings: Undervoltage error threshold	x V (Read only)	general	U16	1	-	-
0x2540:004 (P208.04)	Mains settings: Undervoltage reset threshold	x V (Read only)	general	U16	1	-	-
0x2540:005 (P208.05)	Mains settings: Overvoltage warning threshold	0 V *	general	U16	1	P	-
0x2540:006 (P208.06)	Mains settings: Overvoltage error threshold	x V (Read only)	general	U16	1	-	-
0x2540:007 (P208.07)	Mains settings: Overvoltage reset threshold	x V (Read only)	general	U16	1	-	-
0x2541:001 (P706.01)	Brake energy management: Operating mode	Ramp function generator stop (RFGS) [1]	general	U8	1	P	-
0x2541:002 (P706.02)	Brake energy management: Active threshold	x V (Read only)	general	U16	1	P	-
0x2541:003 (P706.03)	Brake energy management: Reduced threshold	0 V	general	U16	1	P	-
0x2541:004 (P706.04)	Brake energy management: Additional frequency	0.0 Hz	general	U16	10	P	-
0x2541:005 (P706.05)	Brake energy management: Deceleration override time	2.0 s	general	U16	10	P	-
0x2541:006 (P706.06)	Brake energy management: Brake resistor response	Off: disable and error [0]	general	U8	1	PC	-
0x2550:002 (P707.02)	Brake resistor: Resistance value	180.0 Ω *	general	U16	10	P	-
0x2550:003 (P707.03)	Brake resistor: Rated power	50 W *	general	U32	1	P	-
0x2550:004 (P707.04)	Brake resistor: Maximum thermal load	8.0 kW * *	general	U32	10	P	-
0x2550:007 (P707.07)	Brake resistor: Thermal load	x.x % (Read only)	general	U16	10	-	-
0x2550:008 (P707.08)	Brake resistor: Warning threshold	90.0 %	general	U16	10	P	-

* Default setting depending on the size.

Firmware version 04.00.00.00

Appendix

Parameter attribute list



Address	Name	Default setting	Category	Data type	Factor	A	M
0x2550:009 (P707.09)	Brake resistor: Error threshold	100.0 %	general	U16	10	P	-
0x2550:010 (P707.10)	Brake resistor: Response to warning	Warning [1]	general	U8	1	P	-
0x2550:011 (P707.11)	Brake resistor: Response to error	Fault [3]	general	U8	1	P	-
0x2552:002 (P595.02)	Parameter access monitoring: Keep alive register	0	general	U16	1	K	-
0x2552:003 (P595.03)	Parameter access monitoring: Time-out time	10.0 s	general	U16	10	P	-
0x2552:004 (P595.04)	Parameter access monitoring: Reaction	No response [0]	general	U8	1	P	-
0x2552:005 (P595.05)	Parameter access monitoring: Action	No action [0]	general	U8	1	P	-
0x2552:006 (P595.06)	Parameter access monitoring: Parameter Access Monitoring-Status	- (Read only)	general	U16	1	-	-
0x2601:001 (P202.01)	Keypad setpoints: Frequency setpoint	20.0 Hz	general	U16	10	P	r
0x2601:002 (P202.02)	Keypad setpoints: Process controller setpoint	0.00 PID unit	general	I16	100	P	r
0x2601:003 (P202.03)	Keypad setpoints: Torque setpoint	100.0 %	general	I16	10	P	r
0x2602:001 (P708.01)	Keypad setup: CTRL & F/R key setup	CTRL & F/R Enable [1]	general	U8	1	P	-
0x2602:002 (P708.02)	Keypad setup: Keypad rotation setup	Forward [0]	general	U8	1	P	-
0x2602:003 (P708.03)	Keypad setup: Keypad Full Control	Off [0]	general	U8	1	-	-
0x261C:001 (P740.01)	Favorites settings: Parameter 1	0x2DDD0000	general	IDX	1	PH	-
0x261C:002 (P740.02)	Favorites settings: Parameter 2	0x60780000	general	IDX	1	PH	-
0x261C:003 (P740.03)	Favorites settings: Parameter 3	0x2D890000	general	IDX	1	PH	-
0x261C:004 (P740.04)	Favorites settings: Parameter 4	0x603F0000	general	IDX	1	PH	-
0x261C:005 (P740.05)	Favorites settings: Parameter 5	0x28240000	general	IDX	1	PH	-
0x261C:006 (P740.06)	Favorites settings: Parameter 6	0x28600100	general	IDX	1	PH	-
0x261C:007 (P740.07)	Favorites settings: Parameter 7	0x28380100	general	IDX	1	PH	-
0x261C:008 (P740.08)	Favorites settings: Parameter 8	0x28380300	general	IDX	1	PH	-
0x261C:009 (P740.09)	Favorites settings: Parameter 9	0x25400100	general	IDX	1	PH	-
0x261C:010 (P740.10)	Favorites settings: Parameter 10	0x29150000	general	IDX	1	PH	-
0x261C:011 (P740.11)	Favorites settings: Parameter 11	0x29160000	general	IDX	1	PH	-
0x261C:012 (P740.12)	Favorites settings: Parameter 12	0x29170000	general	IDX	1	PH	-
0x261C:013 (P740.13)	Favorites settings: Parameter 13	0x29180000	general	IDX	1	PH	-
0x261C:014 (P740.14)	Favorites settings: Parameter 14	0x2C000000	general	IDX	1	PH	-
0x261C:015 (P740.15)	Favorites settings: Parameter 15	0x2B000000	general	IDX	1	PH	-

* Default setting depending on the size.

Firmware version 04.00.00.00

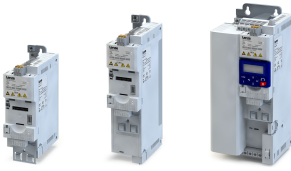

Appendix

Parameter attribute list

Address	Name	Default setting	Category	Data type	Factor	A	M
0x261C:016 (P740.16)	Favorites settings: Parameter 16	0x2B010100	general	IDX	1	PH	-
0x261C:017 (P740.17)	Favorites settings: Parameter 17	0x2B010200	general	IDX	1	PH	-
0x261C:018 (P740.18)	Favorites settings: Parameter 18	0x283A0000	general	IDX	1	PH	-
0x261C:019 (P740.19)	Favorites settings: Parameter 19	0x29390000	general	IDX	1	PH	-
0x261C:020 (P740.20)	Favorites settings: Parameter 20	0x2D4B0100	general	IDX	1	PH	-
0x261C:021 (P740.21)	Favorites settings: Parameter 21	0x2B120100	general	IDX	1	PH	-
0x261C:022 (P740.22)	Favorites settings: Parameter 22	0x60730000	general	IDX	1	PH	-
0x261C:023 (P740.23)	Favorites settings: Parameter 23	0x26310100	general	IDX	1	PH	-
0x261C:024 (P740.24)	Favorites settings: Parameter 24	0x26310200	general	IDX	1	PH	-
0x261C:025 (P740.25)	Favorites settings: Parameter 25	0x26310300	general	IDX	1	PH	-
0x261C:026 (P740.26)	Favorites settings: Parameter 26	0x26310400	general	IDX	1	PH	-
0x261C:027 (P740.27)	Favorites settings: Parameter 27	0x26310500	general	IDX	1	PH	-
0x261C:028 (P740.28)	Favorites settings: Parameter 28	0x26310600	general	IDX	1	PH	-
0x261C:029 (P740.29)	Favorites settings: Parameter 29	0x26310700	general	IDX	1	PH	-
0x261C:030 (P740.30)	Favorites settings: Parameter 30	0x26310800	general	IDX	1	PH	-
0x261C:031 (P740.31)	Favorites settings: Parameter 31	0x26310900	general	IDX	1	PH	-
0x261C:032 (P740.32)	Favorites settings: Parameter 32	0x26310D00	general	IDX	1	PH	-
0x261C:033 (P740.33)	Favorites settings: Parameter 33	0x26311200	general	IDX	1	PH	-
0x261C:034 (P740.34)	Favorites settings: Parameter 34	0x26311300	general	IDX	1	PH	-
0x261C:035 (P740.35)	Favorites settings: Parameter 35	0x26311400	general	IDX	1	PH	-
0x261C:036 (P740.36)	Favorites settings: Parameter 36	0x26340100	general	IDX	1	PH	-
0x261C:037 (P740.37)	Favorites settings: Parameter 37	0x26340200	general	IDX	1	PH	-
0x261C:038 (P740.38)	Favorites settings: Parameter 38	0x26360100	general	IDX	1	PH	-
0x261C:039 (P740.39)	Favorites settings: Parameter 39	0x26360200	general	IDX	1	PH	-
0x261C:040 (P740.40)	Favorites settings: Parameter 40	0x26360300	general	IDX	1	PH	-
0x261C:041 (P740.41)	Favorites settings: Parameter 41	0x26390100	general	IDX	1	PH	-
0x261C:042 (P740.42)	Favorites settings: Parameter 42	0x26390200	general	IDX	1	PH	-
0x261C:043 (P740.43)	Favorites settings: Parameter 43	0x26390300	general	IDX	1	PH	-
0x261C:044 (P740.44)	Favorites settings: Parameter 44	0x26390400	general	IDX	1	PH	-

* Default setting depending on the size.

Firmware version 04.00.00.00

Appendix

Parameter attribute list



Address	Name	Default setting	Category	Data type	Factor	A	M
0x261C:045 (P740.45)	Favorites settings: Parameter 45	0x29110100	general	IDX	1	PH	-
0x261C:046 (P740.46)	Favorites settings: Parameter 46	0x29110200	general	IDX	1	PH	-
0x261C:047 (P740.47)	Favorites settings: Parameter 47	0x29110300	general	IDX	1	PH	-
0x261C:048 (P740.48)	Favorites settings: Parameter 48	0x29110400	general	IDX	1	PH	-
0x261C:049 (P740.49)	Favorites settings: Parameter 49	0x00000000	general	IDX	1	PH	-
0x261C:050 (P740.50)	Favorites settings: Parameter 50	0x00000000	general	IDX	1	PH	-
0x2630:001 (P410.01)	Settings for digital inputs: Assertion level	HIGH active [1]	general	U8	1	P	-
0x2630:002 (P410.02)	Settings for digital inputs: Input function	Digital input [0]	general	U8	1	P	-
0x2631:001 (P400.01)	Function list: Enable inverter	Constant TRUE [1]	general	U8	1	PC	-
0x2631:002 (P400.02)	Function list: Run	Digital input 1 [11]	general	U8	1	PC	-
0x2631:003 (P400.03)	Function list: Activate quick stop	Not connected [0]	general	U8	1	PC	-
0x2631:004 (P400.04)	Function list: Reset fault	Digital input 2 [12]	general	U8	1	P	-
0x2631:005 (P400.05)	Function list: Activate DC braking	Not connected [0]	general	U8	1	P	-
0x2631:006 (P400.06)	Function list: Start forward (CW)	Not connected [0]	general	U8	1	PC	-
0x2631:007 (P400.07)	Function list: Start reverse (CCW)	Not connected [0]	general	U8	1	PC	-
0x2631:008 (P400.08)	Function list: Run forward (CW)	Not connected [0]	general	U8	1	PC	-
0x2631:009 (P400.09)	Function list: Run reverse (CCW)	Not connected [0]	general	U8	1	PC	-
0x2631:010 (P400.10)	Function list: Jog forward (CW)	Not connected [0]	general	U8	1	PC	-
0x2631:011 (P400.11)	Function list: Jog reverse (CCW)	Not connected [0]	general	U8	1	PC	-
0x2631:012 (P400.12)	Function list: Activate keypad control	Not connected [0]	general	U8	1	P	-
0x2631:013 (P400.13)	Function list: Invert rotation	Digital input 3 [13]	general	U8	1	PC	-
0x2631:014 (P400.14)	Function list: Activate AI1 setpoint	Not connected [0]	general	U8	1	P	-
0x2631:015 (P400.15)	Function list: Activate AI2 setpoint	Not connected [0]	general	U8	1	P	-
0x2631:016 (P400.16)	Function list: Activate keypad setpoint	Not connected [0]	general	U8	1	P	-
0x2631:017 (P400.17)	Function list: Activate network setpoint	Not connected [0]	general	U8	1	P	-
0x2631:018 (P400.18)	Function list: Activate preset (bit 0)	Digital input 4 [14]	general	U8	1	P	-
0x2631:019 (P400.19)	Function list: Activate preset (bit 1)	Digital input 5 [15]	general	U8	1	P	-
0x2631:020 (P400.20)	Function list: Activate preset (bit 2)	Not connected [0]	general	U8	1	P	-
0x2631:021 (P400.21)	Function list: Activate preset (bit 3)	Not connected [0]	general	U8	1	P	-

* Default setting depending on the size.

Firmware version 04.00.00.00



Appendix

Parameter attribute list

Address	Name	Default setting	Category	Data type	Factor	A	M
0x2631:022 (P400.22)	Function list: Activate setpoint via HTL input	Not connected [0]	general	U8	1	P	-
0x2631:023 (P400.23)	Function list: MOP setpoint up	Not connected [0]	general	U8	1	P	-
0x2631:024 (P400.24)	Function list: MOP setpoint down	Not connected [0]	general	U8	1	P	-
0x2631:025 (P400.25)	Function list: Activate MOP setpoint	Not connected [0]	general	U8	1	P	-
0x2631:026 (P400.26)	Function list: Activate segment setpoint (bit 0)	Not connected [0]	general	U8	1	P	-
0x2631:027 (P400.27)	Function list: Activate segment setpoint (bit 1)	Not connected [0]	general	U8	1	P	-
0x2631:028 (P400.28)	Function list: Activate segment setpoint (bit 2)	Not connected [0]	general	U8	1	P	-
0x2631:029 (P400.29)	Function list: Activate segment setpoint (bit 3)	Not connected [0]	general	U8	1	P	-
0x2631:030 (P400.30)	Function list: Run/abort sequence	Not connected [0]	general	U8	1	PC	-
0x2631:031 (P400.31)	Function list: Start sequence	Not connected [0]	general	U8	1	PC	-
0x2631:032 (P400.32)	Function list: Next sequence step	Not connected [0]	general	U8	1	PC	-
0x2631:033 (P400.33)	Function list: Pause sequence	Not connected [0]	general	U8	1	PC	-
0x2631:034 (P400.34)	Function list: Suspend sequence	Not connected [0]	general	U8	1	PC	-
0x2631:035 (P400.35)	Function list: Stop sequence	Not connected [0]	general	U8	1	PC	-
0x2631:036 (P400.36)	Function list: Abort sequence	Not connected [0]	general	U8	1	PC	-
0x2631:037 (P400.37)	Function list: Activate network control	Not connected [0]	general	U8	1	P	-
0x2631:039 (P400.39)	Function list: Activate ramp 2	Not connected [0]	general	U8	1	P	-
0x2631:040 (P400.40)	Function list: Load parameter set	Not connected [0]	general	U8	1	PC	-
0x2631:041 (P400.41)	Function list: Select parameter set (bit 0)	Not connected [0]	general	U8	1	PC	-
0x2631:042 (P400.42)	Function list: Select parameter set (bit 1)	Not connected [0]	general	U8	1	PC	-
0x2631:043 (P400.43)	Function list: Activate fault 1	Not connected [0]	general	U8	1	P	-
0x2631:044 (P400.44)	Function list: Activate fault 2	Not connected [0]	general	U8	1	P	-
0x2631:045 (P400.45)	Function list: Deactivate PID controller	Not connected [0]	general	U8	1	P	-
0x2631:046 (P400.46)	Function list: Set process controller output to 0	Not connected [0]	general	U8	1	P	-
0x2631:047 (P400.47)	Function list: Inhibit process controller I-component	Not connected [0]	general	U8	1	P	-
0x2631:048 (P400.48)	Function list: Activate process controller influence ramp	Constant TRUE [1]	general	U8	1	P	-
0x2631:049 (P400.49)	Function list: Release holding brake	Not connected [0]	general	U8	1	PC	-
0x2631:050 (P400.50)	Function list: Select sequence (bit 0)	Not connected [0]	general	U8	1	PC	-
0x2631:051 (P400.51)	Function list: Select sequence (bit 1)	Not connected [0]	general	U8	1	PC	-

* Default setting depending on the size.

Firmware version 04.00.00.00

Appendix

Parameter attribute list



Address	Name	Default setting	Category	Data type	Factor	A	M
0x2631:052 (P400.52)	Function list: Select sequence (bit 2)	Not connected [0]	general	U8	1	PC	-
0x2631:053 (P400.53)	Function list: Select sequence (bit 3)	Not connected [0]	general	U8	1	PC	-
0x2631:054 (P400.54)	Function list: Position counter reset	Not connected [0]	general	U8	1	P	-
0x2632:001 (P411.01)	Inversion of digital inputs: Digital input 1	Not inverted [0]	general	U8	1	P	-
0x2632:002 (P411.02)	Inversion of digital inputs: Digital input 2	Not inverted [0]	general	U8	1	P	-
0x2632:003 (P411.03)	Inversion of digital inputs: Digital input 3	Not inverted [0]	general	U8	1	P	-
0x2632:004 (P411.04)	Inversion of digital inputs: Digital input 4	Not inverted [0]	general	U8	1	P	-
0x2632:005 (P411.05)	Inversion of digital inputs: Digital input 5	Not inverted [0]	general	U8	1	P	-
0x2632:006 (P411.06)	Inversion of digital inputs: Digital input 6	Not inverted [0]	Appl. I/O	U8	1	P	-
0x2632:007 (P411.07)	Inversion of digital inputs: Digital input 7	Not inverted [0]	Appl. I/O	U8	1	P	-
0x2633:001	Digital input debounce time: Digital input 1	1 ms	general	U8	1	P	-
0x2633:002	Digital input debounce time: Digital input 2	1 ms	general	U8	1	P	-
0x2633:003	Digital input debounce time: Digital input 3	1 ms	general	U8	1	P	-
0x2633:004	Digital input debounce time: Digital input 4	1 ms	general	U8	1	P	-
0x2633:005	Digital input debounce time: Digital input 5	1 ms	general	U8	1	P	-
0x2633:006	Digital input debounce time: Digital input 6	1 ms	Appl. I/O	U8	1	P	-
0x2633:007	Digital input debounce time: Digital input 7	1 ms	Appl. I/O	U8	1	P	-
0x2634:001 (P420.01)	Digital outputs function: Relay	Ready for operation [51]	general	U8	1	P	-
0x2634:002 (P420.02)	Digital outputs function: Digital output 1	Release holding brake [115]	general	U8	1	P	-
0x2634:003 (P420.03)	Digital outputs function: Digital output 2	Error active [56]	Appl. I/O	U8	1	P	-
0x2634:010 (P420.10)	Digital outputs function: NetWordOUT1 - bit 0	Ready for operation [51]	general	U8	1	P	-
0x2634:011 (P420.11)	Digital outputs function: NetWordOUT1 - bit 1	Not connected [0]	general	U8	1	P	-
0x2634:012 (P420.12)	Digital outputs function: NetWordOUT1 - bit 2	Operation enabled [52]	general	U8	1	P	-
0x2634:013 (P420.13)	Digital outputs function: NetWordOUT1 - bit 3	Error active [56]	general	U8	1	P	-
0x2634:014 (P420.14)	Digital outputs function: NetWordOUT1 - bit 4	Not connected [0]	general	U8	1	P	-
0x2634:015 (P420.15)	Digital outputs function: NetWordOUT1 - bit 5	Quick stop active [54]	general	U8	1	P	-
0x2634:016 (P420.16)	Digital outputs function: NetWordOUT1 - bit 6	Running [50]	general	U8	1	P	-
0x2634:017 (P420.17)	Digital outputs function: NetWordOUT1 - bit 7	Device warning active [58]	general	U8	1	P	-
0x2634:018 (P420.18)	Digital outputs function: NetWordOUT1 - bit 8	Not connected [0]	general	U8	1	P	-
0x2634:019 (P420.19)	Digital outputs function: NetWordOUT1 - bit 9	Not connected [0]	general	U8	1	P	-
0x2634:020 (P420.20)	Digital outputs function: NetWordOUT1 - bit 10	Setpoint speed reached [72]	general	U8	1	P	-
0x2634:021 (P420.21)	Digital outputs function: NetWordOUT1 - bit 11	Current limit reached [78]	general	U8	1	P	-
0x2634:022 (P420.22)	Digital outputs function: NetWordOUT1 - bit 12	Actual speed = 0 [71]	general	U8	1	P	-

* Default setting depending on the size.

Firmware version 04.00.00.00

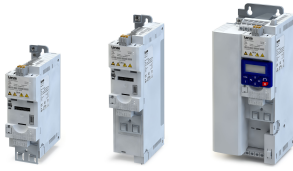

Appendix

Parameter attribute list

Address	Name	Default setting	Category	Data type	Factor	A	M
0x2634:023 (P420.23)	Digital outputs function: NetWordOUT1 - bit 13	Rotational direction reversed [69]	general	U8	1	P	-
0x2634:024 (P420.24)	Digital outputs function: NetWordOUT1 - bit 14	Release holding brake [115]	general	U8	1	P	-
0x2634:025 (P420.25)	Digital outputs function: NetWordOUT1 - bit 15	Safe torque off (STO) active [55]	general	U8	1	P	-
0x2635:001 (P421.01)	Inversion of digital outputs: Relay	Not inverted [0]	general	U8	1	P	-
0x2635:002 (P421.02)	Inversion of digital outputs: Digital output 1	Not inverted [0]	general	U8	1	P	-
0x2635:003 (P421.03)	Inversion of digital outputs: Digital output 2	Not inverted [0]	Appl. I/O	U8	1	P	-
0x2635:010	Inversion of digital outputs: NetWordOUT1.00	Not inverted [0]	general	U8	1	P	-
0x2635:011	Inversion of digital outputs: NetWordOUT1.01	Not inverted [0]	general	U8	1	P	-
0x2635:012	Inversion of digital outputs: NetWordOUT1.02	Not inverted [0]	general	U8	1	P	-
0x2635:013	Inversion of digital outputs: NetWordOUT1.03	Not inverted [0]	general	U8	1	P	-
0x2635:014	Inversion of digital outputs: NetWordOUT1.04	Not inverted [0]	general	U8	1	P	-
0x2635:015	Inversion of digital outputs: NetWordOUT1.05	Not inverted [0]	general	U8	1	P	-
0x2635:016	Inversion of digital outputs: NetWordOUT1.06	Not inverted [0]	general	U8	1	P	-
0x2635:017	Inversion of digital outputs: NetWordOUT1.07	Not inverted [0]	general	U8	1	P	-
0x2635:018	Inversion of digital outputs: NetWordOUT1.08	Not inverted [0]	general	U8	1	P	-
0x2635:019	Inversion of digital outputs: NetWordOUT1.09	Not inverted [0]	general	U8	1	P	-
0x2635:020	Inversion of digital outputs: NetWordOUT1.10	Not inverted [0]	general	U8	1	P	-
0x2635:021	Inversion of digital outputs: NetWordOUT1.11	Not inverted [0]	general	U8	1	P	-
0x2635:022	Inversion of digital outputs: NetWordOUT1.12	Not inverted [0]	general	U8	1	P	-
0x2635:023	Inversion of digital outputs: NetWordOUT1.13	Not inverted [0]	general	U8	1	P	-
0x2635:024	Inversion of digital outputs: NetWordOUT1.14	Not inverted [0]	general	U8	1	P	-
0x2635:025	Inversion of digital outputs: NetWordOUT1.15	Not inverted [0]	general	U8	1	P	-
0x2636:001 (P430.01)	Analog input 1: Input range	0 ... 10 VDC [0]	general	U8	1	P	-
0x2636:002 (P430.02)	Analog input 1: Min frequency value	0.0 Hz	general	I16	10	P	-
0x2636:003 (P430.03)	Analog input 1: Max frequency value	Device for 50-Hz mains: 50.0 Hz Device for 60-Hz mains: 60.0 Hz	general	I16	10	P	-
0x2636:004 (P430.04)	Analog input 1: Min PID value	0.00 PID unit	general	I16	100	P	-
0x2636:005 (P430.05)	Analog input 1: Max PID value	100.00 PID unit	general	I16	100	P	-
0x2636:006 (P430.06)	Analog input 1: Filter time	10 ms	general	U16	1	P	-
0x2636:007 (P430.07)	Analog input 1: Dead band	0.0 %	general	U16	10	P	-
0x2636:008 (P430.08)	Analog input 1: Monitoring threshold	0.0 %	general	I16	10	P	-
0x2636:009 (P430.09)	Analog input 1: Monitoring condition	Input value < trigger threshold [0]	general	U8	1	P	-
0x2636:010 (P430.10)	Analog input 1: Error response	Fault [3]	general	U8	1	P	-
0x2636:011 (P430.11)	Analog input 1: Min torque value	0.0 %	general	I16	10	P	-
0x2636:012 (P430.12)	Analog input 1: Max torque value	100.0 %	general	I16	10	P	-
0x2637:001 (P431.01)	Analog input 2: Input range	0 ... 10 VDC [0]	general	U8	1	P	-
0x2637:002 (P431.02)	Analog input 2: Min frequency value	0.0 Hz	general	I16	10	P	-

* Default setting depending on the size.

Firmware version 04.00.00.00

Appendix

Parameter attribute list



Address	Name	Default setting	Category	Data type	Factor	A	M
0x2637:003 (P431.03)	Analog input 2: Max frequency value	Device for 50-Hz mains: 50.0 Hz Device for 60-Hz mains: 60.0 Hz	general	I16	10	P	-
0x2637:004 (P431.04)	Analog input 2: Min PID value	0.00 PID unit	general	I16	100	P	-
0x2637:005 (P431.05)	Analog input 2: Max PID value	100.00 PID unit	general	I16	100	P	-
0x2637:006 (P431.06)	Analog input 2: Filter time	10 ms	general	U16	1	P	-
0x2637:007 (P431.07)	Analog input 2: Dead band	0.0 %	general	U16	10	P	-
0x2637:008 (P431.08)	Analog input 2: Monitoring threshold	0.0 %	general	I16	10	P	-
0x2637:009 (P431.09)	Analog input 2: Monitoring condition	Input value < trigger threshold [0]	general	U8	1	P	-
0x2637:010 (P431.10)	Analog input 2: Error response	Fault [3]	general	U8	1	P	-
0x2637:011 (P431.11)	Analog input 2: Min torque value	0.0 %	general	I16	10	P	-
0x2637:012 (P431.12)	Analog input 2: Max torque value	100.0 %	general	I16	10	P	-
0x2639:001 (P440.01)	Analog output 1: Output range	0 ... 10 VDC [1]	general	U8	1	P	-
0x2639:002 (P440.02)	Analog output 1: Function	Output frequency [1]	general	U8	1	P	-
0x2639:003 (P440.03)	Analog output 1: Min. signal	0	general	I32	1	P	-
0x2639:004 (P440.04)	Analog output 1: Max. signal	1000	general	I32	1	P	-
0x263A:001 (P441.01)	Analog output 2: Output range	0 ... 10 VDC [1]	Appl. I/O	U8	1	P	-
0x263A:002 (P441.02)	Analog output 2: Function	Motor current [5]	Appl. I/O	U8	1	P	-
0x263A:003 (P441.03)	Analog output 2: Min. signal	0	Appl. I/O	I32	1	P	-
0x263A:004 (P441.04)	Analog output 2: Max. signal	1000	Appl. I/O	I32	1	P	-
0x2640:001 (P415.01)	HTL input settings: Minimum frequency	0.0 Hz	general	I32	10	P	-
0x2640:002 (P415.02)	HTL input settings: Maximum frequency	0.0 Hz	general	I32	10	P	-
0x2640:003 (P415.03)	HTL input settings: Minimum motor frequency	0.0 Hz	general	I16	10	P	-
0x2640:004 (P415.04)	HTL input settings: Maximum motor frequency	Device for 50-Hz mains: 50.0 Hz Device for 60-Hz mains: 60.0 Hz	general	I16	10	P	-
0x2640:005 (P415.05)	HTL input settings: Minimum PID setpoint	0.00 PID unit	general	I16	100	P	-
0x2640:006 (P415.06)	HTL input settings: Maximum PID setpoint	100.00 PID unit	general	I16	100	P	-
0x2640:007 (P415.07)	HTL input settings: Minimum torque setpoint	0.0 %	general	I16	10	P	-
0x2640:008 (P415.08)	HTL input settings: Maximum torque setpoint	100.0 %	general	I16	10	P	-
0x2640:009 (P415.09)	HTL input settings: Filter time constant	10 ms	general	U16	1	P	-
0x2641:001 (P416.01)	HTL input monitoring: Minimum frequency threshold	0.0 Hz	general	I32	10	P	-

* Default setting depending on the size.

Firmware version 04.00.00.00



Appendix

Parameter attribute list

Address	Name	Default setting	Category	Data type	Factor	A	M
0x2641:002 (P416.02)	HTL input monitoring: Minimum delay threshold	5.0 s	general	U16	10	P	-
0x2641:003 (P416.03)	HTL input monitoring: Maximum frequency threshold	0.0 Hz	general	I32	10	P	-
0x2641:004 (P416.04)	HTL input monitoring: Maximum delay threshold	5.0 s	general	U16	10	P	-
0x2641:005 (P416.05)	HTL input monitoring: Monitoring conditions	Below minimum frequency [1]	general	U8	1	P	-
0x2641:006 (P416.06)	HTL input monitoring: Error response	Warning [1]	general	U8	1	P	-
0x2642:001 (P115.01)	HTL input diagnostics: Input frequency	x.x Hz (Read only)	general	I32	10	-	-
0x2642:002 (P115.02)	HTL input diagnostics: Frequency setpoint	x.x Hz (Read only)	general	I16	10	-	t
0x2642:003 (P115.03)	HTL input diagnostics: PID setpoint	x.xx PID unit (Read only)	general	I16	100	-	t
0x2642:004 (P115.04)	HTL input diagnostics: Torque setpoint	x.x % (Read only)	general	I16	10	-	t
0x2820:001 (P712.01)	Holding brake control: Brake mode	Off [2]	general	U8	1	P	r
0x2820:002 (P712.02)	Holding brake control: Brake closing time	100 ms	general	U16	1	P	-
0x2820:003 (P712.03)	Holding brake control: Brake opening time	100 ms	general	U16	1	P	-
0x2820:007 (P712.07)	Holding brake control: Brake closing threshold	0.2 Hz	general	U16	10	P	-
0x2820:008 (P712.08)	Holding brake control: Brake holding load	0.0 %	general	I16	10	P	-
0x2820:012 (P712.12)	Holding brake control: Closing threshold delay	0 ms	general	U16	1	P	-
0x2820:013 (P712.13)	Holding brake control: Holding load ramptime	0 ms	general	U16	1	P	-
0x2820:015 (P712.15)	Holding brake control: Brake status	- (Read only)	general	U8	1	-	-
0x2822:001	Enable inverter	Inverter inhibited [0]	general	U8	1	-	-
0x2822:002	Activate quick stop	0	general	U8	1	-	-
0x2822:003	Reset error	0	general	U8	1	-	-
0x2822:004 (P327.04)	Identify motor data (energized)	0	general	U8	1	-	-
0x2822:005 (P327.05)	Calibrate motor data (non-energized)	0	general	U8	1	-	-
0x2822:019	Calculate I _{max} controller parameter	0	general	U8	1	-	-
0x2822:028	Initialize device controller	0	general	U8	1	-	-
0x2823:001	Last subindex	- (Read only)	general	U8	1	-	-
0x2823:002	Status of last axis command	- (Read only)	general	U8	1	-	-
0x2824 (P200.00)	Control selection	Flexible I/O configuration [0]	general	U8	1	P	-
0x2826	Time-out for error response	6.0 s	general	U16	10	P	-
0x2827 (P198.00)	Currently loaded parameter settings	- (Read only)	general	U8	1	-	-
0x2829 (P732.00)	Automatic storage in the memory module	Inhibit [0]	general	U8	1	P	-
0x282A:001 (P126.01)	Status words: Cause of disable	- (Read only)	general	U32	1	O	-
0x282A:002 (P126.02)	Status words: Cause of quick stop	- (Read only)	general	U16	1	O	-
0x282A:003 (P126.03)	Status words: Cause of stop	- (Read only)	general	U16	1	O	-

* Default setting depending on the size.

Firmware version 04.00.00.00

Appendix

Parameter attribute list



Address	Name	Default setting	Category	Data type	Factor	A	M
0x282A:004	Status words: Extended status word	- (Read only)	general	U16	1	O	t
0x282A:005 (P126.05)	Status words: Device status	- (Read only)	general	U8	1	O	t
0x282B:001 (P125.01)	Inverter diagnostics: Active control source	- (Read only)	general	U8	1	O	t
0x282B:002 (P125.02)	Inverter diagnostics: Active setpoint source	- (Read only)	general	U8	1	O	t
0x282B:003 (P125.03)	Inverter diagnostics: Keypad LCD status	- (Read only)	general	U8	1	O	-
0x282B:004 (P125.04)	Inverter diagnostics: Active drive mode	- (Read only)	general	U8	1	O	t
0x282B:005 (P125.05)	Inverter diagnostics: Most recently used control register	- (Read only)	general	U32	1	OH	-
0x282B:006 (P125.06)	Inverter diagnostics: Most recently used setpoint register	- (Read only)	general	U32	1	OH	-
0x282B:007	Inverter diagnostics: Default frequency setpoint	x.x Hz (Read only)	general	I16	10	-	-
0x282B:008	Inverter diagnostics: Preset frequency setpoint	x.x Hz (Read only)	general	I16	10	-	-
0x282B:009	Inverter diagnostics: Actual frequency setpoint	x.x Hz (Read only)	general	I16	10	-	-
0x282B:010	Inverter diagnostics: Default PID setpoint	x.xx PID unit (Read only)	general	I16	100	-	-
0x282B:011	Inverter diagnostics: Preset PID setpoint	x.xx PID unit (Read only)	general	I16	100	-	-
0x282B:012	Inverter diagnostics: Default torque setpoint	x.x % (Read only)	general	I16	10	-	-
0x282B:013	Inverter diagnostics: Preset torque setpoint	x.x % (Read only)	general	I16	10	-	-
0x2831	Inverter status word	- (Read only)	general	U16	1	O	t
0x2832	Motor identification status	- (Read only)	general	U16	1	O	-
0x2833	Inverter status word 2	- (Read only)	general	U16	1	O	t
0x2838:001 (P203.01)	Start/stop configuration: Start method	Normal [0]	general	U8	1	PC	-
0x2838:002 (P203.02)	Start/stop configuration: Start at power-up	Off [0]	general	U8	1	P	-
0x2838:003 (P203.03)	Start/stop configuration: Stop method	Standard ramp [1]	general	U8	1	P	-
0x2839:002 (P760.02)	Fault configuration: Restart delay	3.0 s	general	U16	10	P	-
0x2839:003 (P760.03)	Fault configuration: Number of restart attempts	5	general	U8	1	P	-
0x2839:004 (P760.04)	Fault configuration: Trouble counter reset time	5.0 s	general	U16	10	P	-
0x2839:005 (P760.05)	Fault configuration: Trouble counter	- (Read only)	general	U8	1	-	-
0x283A (P304.00)	Limitation of rotation	Both rotation directions [1]	general	U8	1	P	-
0x2857:001	CANopen monitoring: RPDO1-Timeout	Fault [3]	CANopen	U8	1	P	-
0x2857:002	CANopen monitoring: RPDO2-Timeout	Fault [3]	CANopen	U8	1	P	-
0x2857:003	CANopen monitoring: RPDO3-Timeout	Fault [3]	CANopen	U8	1	P	-
0x2857:005	CANopen monitoring: Heartbeat-Timeout Consumer 1	Fault [3]	CANopen	U8	1	P	-
0x2857:006	CANopen monitoring: Heartbeat-Timeout Consumer 2	Fault [3]	CANopen	U8	1	P	-
0x2857:007	CANopen monitoring: Heartbeat-Timeout Consumer 3	Fault [3]	CANopen	U8	1	P	-
0x2857:008	CANopen monitoring: Heartbeat-Timeout Consumer 4	Fault [3]	CANopen	U8	1	P	-
0x2857:010	CANopen monitoring: "Bus-off" state change	Trouble [2]	CANopen	U8	1	P	-
0x2857:011	CANopen monitoring: Warning	Warning [1]	CANopen	U8	1	P	-
0x2858:001 (P515.01)	Modbus monitoring: Response to time-out	Fault [3]	Modbus RTU	U8	1	P	-
0x2858:002 (P515.02)	Modbus monitoring: Time-out time	2.0 s	Modbus RTU	U16	10	P	-

* Default setting depending on the size.

Firmware version 04.00.00.00

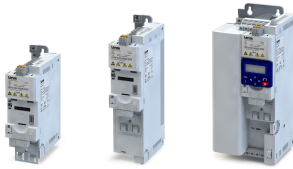

Appendix

Parameter attribute list

Address	Name	Default setting	Category	Data type	Factor	A	M
0x2859:001 (P515.01)	PROFIBUS monitoring: Watchdog elapsed	Fault [3]	PROFIBUS	U8	1	P	-
0x2859:001 (P515.01)	EtherNet/IP monitoring: Watchdog elapsed	Trouble [2]	EtherNet/IP	U8	1	P	-
0x2859:001 (P515.01)	PROFINET monitoring: Watchdog elapsed	Trouble [2]	PROFINET	U8	1	P	-
0x2859:001 (P515.01)	EtherCAT monitoring: Watchdog elapsed	Trouble [2]	EtherCAT	U8	1	P	-
0x2859:002 (P515.02)	PROFIBUS monitoring: Data exchange completed	No response [0]	PROFIBUS	U8	1	P	-
0x2859:003 (P515.03)	PROFIBUS monitoring: Invalid configuration	Fault [3]	PROFIBUS	U8	1	P	-
0x2859:003 (P515.03)	EtherNet/IP monitoring: Invalid configuration	Trouble [2]	EtherNet/IP	U8	1	P	-
0x2859:003 (P515.03)	Modbus TCP/IP monitoring: Configuration error	Trouble [2]	Modbus TCP/IP	U8	1	P	-
0x2859:003 (P515.03)	PROFINET monitoring: Invalid configuration	Trouble [2]	PROFINET	U8	1	P	-
0x2859:003 (P515.03)	EtherCAT monitoring: Invalid configuration	Trouble [2]	EtherCAT	U8	1	P	-
0x2859:004 (P515.04)	PROFIBUS monitoring: Initialisation error	Fault [3]	PROFIBUS	U8	1	P	-
0x2859:004 (P515.04)	EtherNet/IP monitoring: Initialisation error	Trouble [2]	EtherNet/IP	U8	1	P	-
0x2859:004 (P515.04)	Modbus TCP/IP monitoring: Initialisation error	Trouble [2]	Modbus TCP/IP	U8	1	P	-
0x2859:004 (P515.04)	PROFINET monitoring: Initialisation error	Trouble [2]	PROFINET	U8	1	P	-
0x2859:004 (P515.04)	EtherCAT monitoring: Initialisation error	Trouble [2]	EtherCAT	U8	1	P	-
0x2859:005 (P515.05)	PROFIBUS monitoring: Invalid process data	Trouble [2]	PROFIBUS	U8	1	P	-
0x2859:005 (P515.05)	EtherNet/IP monitoring: Invalid process data	Trouble [2]	EtherNet/IP	U8	1	P	-
0x2859:005 (P515.05)	PROFINET monitoring: Invalid process data	Trouble [2]	PROFINET	U8	1	P	-
0x2859:005 (P515.05)	EtherCAT monitoring: Invalid process data	Trouble [2]	EtherCAT	U8	1	P	-
0x2859:006 (P515.06)	EtherNet/IP monitoring: Timeout explicit message	Warning [1]	EtherNet/IP	U8	1	P	-
0x2859:007 (P515.07)	EtherNet/IP monitoring: Timeout communication	Warning [1]	EtherNet/IP	U8	1	P	-
0x2859:007 (P515.07)	Modbus TCP/IP monitoring: Fault reaction by time-out Network	Warning [1]	Modbus TCP/IP	U8	1	P	-
0x2859:008 (P515.08)	Modbus TCP/IP monitoring: Fault reaction by time-out Master	Fault [3]	Modbus TCP/IP	U8	1	P	-
0x2859:009 (P515.09)	Modbus TCP/IP monitoring: Fault reaction by time-out Keep alive	Fault [3]	Modbus TCP/IP	U8	1	P	-
0x2860:001 (P201.01)	Frequency control: Default setpoint source	Analog input 1 [2]	general	U8	1	P	-
0x2860:002 (P201.02)	PID control: Default setpoint source	Keypad [1]	general	U8	1	P	-
0x2860:003 (P201.03)	Torque control: Default setpoint source	Analog input 1 [2]	general	U8	1	P	-
0x2862 (P701.00)	Keypad setpoint increment	1	general	U16	1	P	-
0x2863 (P705.00)	Keypad language selection	English [1]	general	U8	1	P	-

* Default setting depending on the size.

Firmware version 04.00.00.00

Appendix

Parameter attribute list



Address	Name	Default setting	Category	Data type	Factor	A	M
0x2864 (P703.00)	Keypad status display	0x00000000	general	IDX	1	PH	-
0x2900:001 (P332.01)	Speed controller settings: Gain	0.00193 Nm/rpm *	MCTRL	U32	100000	P	-
0x2900:002 (P332.02)	Speed controller settings: Reset time	80.0 ms *	MCTRL	U16	10	P	-
0x2901	Speed controller gain adaption	100.00 %	MCTRL	U16	100	OP	r
0x2904	Actual speed filter time	2.0 ms	MCTRL	U16	10	P	-
0x2910:001 (P335.01)	Motor moment of inertia	3.70 kg cm ² *	MCTRL	U32	100	P	-
0x2910:002 (P335.02)	Load moment of inertia	3.70 kg cm ² *	MCTRL	U32	100	P	-
0x2910:003	Coupling	With backlash [2]	MCTRL	U8	1	P	-
0x2911:001 (P450.01)	Frequency setpoint presets: Preset 1	20.0 Hz	general	U16	10	P	-
0x2911:002 (P450.02)	Frequency setpoint presets: Preset 2	40.0 Hz	general	U16	10	P	-
0x2911:003 (P450.03)	Frequency setpoint presets: Preset 3	Device for 50-Hz mains: 50.0 Hz Device for 60-Hz mains: 60.0 Hz	general	U16	10	P	-
0x2911:004 (P450.04)	Frequency setpoint presets: Preset 4	0.0 Hz	general	U16	10	P	-
0x2911:005 (P450.05)	Frequency setpoint presets: Preset 5	0.0 Hz	general	U16	10	P	-
0x2911:006 (P450.06)	Frequency setpoint presets: Preset 6	0.0 Hz	general	U16	10	P	-
0x2911:007 (P450.07)	Frequency setpoint presets: Preset 7	0.0 Hz	general	U16	10	P	-
0x2911:008 (P450.08)	Frequency setpoint presets: Preset 8	0.0 Hz	general	U16	10	P	-
0x2911:009 (P450.09)	Frequency setpoint presets: Preset 9	0.0 Hz	general	U16	10	P	-
0x2911:010 (P450.10)	Frequency setpoint presets: Preset 10	0.0 Hz	general	U16	10	P	-
0x2911:011 (P450.11)	Frequency setpoint presets: Preset 11	0.0 Hz	general	U16	10	P	-
0x2911:012 (P450.12)	Frequency setpoint presets: Preset 12	0.0 Hz	general	U16	10	P	-
0x2911:013 (P450.13)	Frequency setpoint presets: Preset 13	0.0 Hz	general	U16	10	P	-
0x2911:014 (P450.14)	Frequency setpoint presets: Preset 14	0.0 Hz	general	U16	10	P	-
0x2911:015 (P450.15)	Frequency setpoint presets: Preset 15	0.0 Hz	general	U16	10	P	-
0x2912:001 (P452.01)	Torque setpoint presets: Preset 1	100.0 %	general	I16	10	P	-
0x2912:002 (P452.02)	Torque setpoint presets: Preset 2	100.0 %	general	I16	10	P	-
0x2912:003 (P452.03)	Torque setpoint presets: Preset 3	100.0 %	general	I16	10	P	-
0x2912:004 (P452.04)	Torque setpoint presets: Preset 4	100.0 %	general	I16	10	P	-
0x2912:005 (P452.05)	Torque setpoint presets: Preset 5	100.0 %	general	I16	10	P	-
0x2912:006 (P452.06)	Torque setpoint presets: Preset 6	100.0 %	general	I16	10	P	-
0x2912:007 (P452.07)	Torque setpoint presets: Preset 7	100.0 %	general	I16	10	P	-
* Default setting depending on the size.					Firmware version 04.00.00.00		

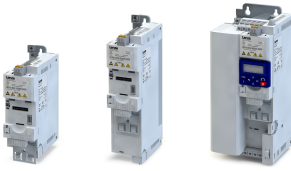

Appendix

Parameter attribute list

Address	Name	Default setting	Category	Data type	Factor	A	M
0x2912:008 (P452.08)	Torque setpoint presets: Preset 8	100.0 %	general	I16	10	P	-
0x2915 (P210.00)	Minimum frequency	0.0 Hz	general	U16	10	P	-
0x2916 (P211.00)	Maximum frequency	Device for 50-Hz mains: 50.0 Hz Device for 60-Hz mains: 60.0 Hz	general	U16	10	P	-
0x2917 (P220.00)	Acceleration time 1	5.0 s	general	U16	10	P	rt
0x2918 (P221.00)	Deceleration time 1	5.0 s	general	U16	10	P	rt
0x2919 (P222.00)	Acceleration time 2	5.0 s	general	U16	10	P	-
0x291A (P223.00)	Deceleration time 2	5.0 s	general	U16	10	P	-
0x291B (P224.00)	Auto-changeover threshold of ramp 2	0.0 Hz	general	U16	10	P	-
0x291C (P225.00)	Quick stop deceleration time	1.0 s	general	U16	10	P	-
0x291E:001 (P226.01)	S-Ramp characteristic: Smoothing factor	0.0 %	general	U16	10	P	-
0x291F:001 (P317.01)	Skip frequencies: Skip frequency 1	0.0 Hz	general	U16	10	P	-
0x291F:002 (P317.02)	Skip frequencies: Skip bandwidth 1	0.0 Hz	general	U8	10	P	-
0x291F:003 (P317.03)	Skip frequencies: Skip frequency 2	0.0 Hz	general	U16	10	P	-
0x291F:004 (P317.04)	Skip frequencies: Skip bandwidth 2	0.0 Hz	general	U8	10	P	-
0x291F:005 (P317.05)	Skip frequencies: Skip frequency 3	0.0 Hz	general	U16	10	P	-
0x291F:006 (P317.06)	Skip frequencies: Skip bandwidth 3	0.0 Hz	general	U8	10	P	-
0x291F:016	Skip frequencies: Status	- (Read only)	general	U16	1	-	-
0x291F:032	Skip frequencies: Input frequency	x.xx Hz (Read only)	general	I32	100	-	-
0x291F:033	Skip frequencies: Output frequency	x.xx Hz (Read only)	general	I32	100	-	-
0x2939 (P305.00)	Switching frequency	0 *	general	U8	1	P	-
0x2942:001 (P334.01)	Current controller parameters: Gain	42.55 V/A *	MCTRL	U32	100	P	-
0x2942:002 (P334.02)	Current controller parameters: Reset time	4.50 ms *	MCTRL	U32	100	P	-
0x2946:001 (P340.01)	Speed limitation: Upper speed limit	0 vel. unit	general	I32	480000/ 2 ³¹	OP	r
0x2946:002 (P340.02)	Speed limitation: Lower speed limit	0 vel. unit	general	I32	480000/ 2 ³¹	OP	r
0x2946:003 (P340.03)	Speed limitation: Upper speed limit source	Maximum frequency [0]	general	U8	1	P	-
0x2946:004 (P340.04)	Speed limitation: Lower speed limit source	(-) Maximum frequency [0]	general	U8	1	P	-
0x2946:005 (P340.05)	Speed limitation: Upper frequency limit	Device for 50-Hz mains: 50.0 Hz Device for 60-Hz mains: 60.0 Hz	general	I16	10	P	-
0x2946:006 (P340.06)	Speed limitation: Lower frequency limit	Device for 50-Hz mains: -50.0 Hz Device for 60-Hz mains: -60.0 Hz	general	I16	10	P	-

* Default setting depending on the size.

Firmware version 04.00.00.00

Appendix

Parameter attribute list



Address	Name	Default setting	Category	Data type	Factor	A	M
0x2946:007 (P340.07)	Speed limitation: Actual upper speed limit	x.x Hz (Read only)	general	I16	10	-	-
0x2946:008 (P340.08)	Speed limitation: Actual lower speed limit	x.x Hz (Read only)	general	I16	10	-	-
0x2947:001	Inverter characteristic: Value y1	0.00 V *	MCTRL	U16	100	P	-
0x2947:002	Inverter characteristic: Value y2	0.00 V *	MCTRL	U16	100	P	-
0x2947:003	Inverter characteristic: Value y3	0.00 V *	MCTRL	U16	100	P	-
0x2947:004	Inverter characteristic: Value y4	0.00 V *	MCTRL	U16	100	P	-
0x2947:005	Inverter characteristic: Value y5	0.00 V *	MCTRL	U16	100	P	-
0x2947:006	Inverter characteristic: Value y6	0.00 V *	MCTRL	U16	100	P	-
0x2947:007	Inverter characteristic: Value y7	0.00 V *	MCTRL	U16	100	P	-
0x2947:008	Inverter characteristic: Value y8	0.00 V *	MCTRL	U16	100	P	-
0x2947:009	Inverter characteristic: Value y9	0.00 V *	MCTRL	U16	100	P	-
0x2947:010	Inverter characteristic: Value y10	0.00 V *	MCTRL	U16	100	P	-
0x2947:011	Inverter characteristic: Value y11	0.00 V *	MCTRL	U16	100	P	-
0x2947:012	Inverter characteristic: Value y12	0.00 V *	MCTRL	U16	100	P	-
0x2947:013	Inverter characteristic: Value y13	0.00 V *	MCTRL	U16	100	P	-
0x2947:014	Inverter characteristic: Value y14	0.00 V *	MCTRL	U16	100	P	-
0x2947:015	Inverter characteristic: Value y15	0.00 V *	MCTRL	U16	100	P	-
0x2947:016	Inverter characteristic: Value y16	0.00 V *	MCTRL	U16	100	P	-
0x2947:017	Inverter characteristic: Value y17	0.00 V *	MCTRL	U16	100	P	-
0x2948:001	Actual torque setpoint	x.x % (Read only)	general	I16	10	-	-
0x2948:002 (P336.02)	ramp time	1.0 s	general	U16	10	P	-
0x2949:001 (P337.01)	Positive torque limit source	Max torque [0]	general	U8	1	P	-
0x2949:002 (P337.02)	Negative torque limit source	(-) Max torque [0]	general	U8	1	P	-
0x2949:003 (P337.03)	Actual positive torque limit	x.x % (Read only)	general	I16	10	-	-
0x2949:004 (P337.04)	Actual negative torque limit	x.x % (Read only)	general	I16	10	-	-
0x29C0:001	Gain	59.68 A/Vs *	MCTRL	U32	100	P	-
0x29C0:002	Reset time	45.5 ms *	MCTRL	U16	10	P	-
0x29E0:001	Field weakening controller settings: Gain	0.000 Vs/V *	MCTRL	U32	1000	P	-
0x29E0:002	Field weakening controller settings: Reset time	1478.3 ms *	MCTRL	U32	10	P	-
0x29E1	Field weakening controller Field limitation	100.00 %	MCTRL	U16	100	OP	r
0x29E2	DC-bus filter time	25.0 ms	MCTRL	U16	10	P	-
0x29E3	Motor voltage filter time	25.0 ms	MCTRL	U16	10	P	-
0x29E4 (P354.00)	Voltage reserve range	5 %	general	U8	1	P	-
0x2B00 (P302.00)	V/f characteristic shape	Linear [0]	general	U8	1	PC	-
0x2B01:001 (P303.01)	V/f shape data: Base voltage	230 V *	MCTRL	U16	1	P	-
0x2B01:002 (P303.02)	V/f shape data: Base frequency	Device for 50-Hz mains: 50 Hz Device for 60-Hz mains: 60 Hz *	MCTRL	U16	1	P	-
0x2B01:003 (P303.03)	V/f shape data: Midpoint voltage	0 V	MCTRL	U16	1	P	-
0x2B01:004 (P303.04)	V/f shape data: Midpoint frequency	0 Hz	MCTRL	U16	1	P	-
0x2B08:001 (P333.01)	V/f I _{max} controller: Gain	0.284 Hz/A *	MCTRL	U32	1000	P	-
0x2B08:002 (P333.02)	V/f I _{max} controller: Reset time	2.3 ms *	MCTRL	U32	10	P	-

* Default setting depending on the size.

Firmware version 04.00.00.00

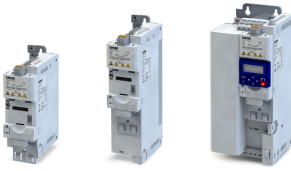

Appendix

Parameter attribute list

Address	Name	Default setting	Category	Data type	Factor	A	M
0x2B09:001 (P315.01)	Slip compensation: Gain	100.00 %	general	I16	100	P	-
0x2B09:002 (P315.02)	Slip compensation: Filter time	5 ms	general	U16	1	P	-
0x2B0A:001 (P318.01)	Gain	20 %	MCTRL	I16	1	P	-
0x2B0A:002 (P318.02)	Filter time	5 ms	MCTRL	U16	1	P	-
0x2B0B	Frequency setpoint	x.x Hz (Read only)	general	I16	10	O	t
0x2B0C (P319.00)	Override field weakening	0.0 Hz	general	I16	10	P	-
0x2B0D:001 (P330.01)	VFC-ECO: Minimum voltage	20 %	MCTRL	I16	1	P	-
0x2B0E (P102.00)	Frequency setpoint	x.x Hz (Read only)	general	I16	10	O	t
0x2B0F	VFC output frequency	x.x Hz (Read only)	MCTRL	I16	10	O	t
0x2B12:001 (P316.01)	Fixed boost	2.5 % *	MCTRL	U8	10	P	-
0x2B12:002 (P316.02)	V/f voltage boost: Boost at acceleration	0.0 %	general	U8	10	P	-
0x2B13:001	Additive voltage impression: Enable Function	Disable [0]	general	U8	1	P	-
0x2B13:002	Additive voltage impression: Setpoint source	Analog input 1 [1]	general	U8	1	P	-
0x2B13:003	Additive voltage impression: Actual voltage	x V (Read only)	general	I16	1	-	-
0x2B14:001	Gain	0.100	MCTRL	U16	1000	P	-
0x2B14:002	Reset time	100.0 ms	MCTRL	U16	10	P	-
0x2B14:003	Frequency limitation	10.00 Hz	MCTRL	U16	100	P	-
0x2B40:001	Gain	0.2686 Hz/A *	MCTRL	U32	10000	P	-
0x2B40:002	Reset time	2.3 ms *	MCTRL	U32	10	P	-
0x2B40:003	Q-Feedforward	0.00	MCTRL	U32	100	P	-
0x2B40:004	D-Feedforward	0.00	MCTRL	U32	100	P	-
0x2B84:001 (P704.01)	DC braking: Current	0.0 %	general	U16	10	P	-
0x2B84:002 (P704.02)	DC braking: Automatic hold time	0.0 s	general	U16	10	P	-
0x2B84:003 (P704.03)	DC braking: Automatic operating threshold	0.0 Hz	general	U16	10	P	-
0x2B84:004 (P704.04)	DC braking: Demagnetization time	100 %	general	U8	1	P	-
0x2B84:005 (P704.05)	DC braking: Default demagnetization time	x ms (Read only)	general	U16	1	-	-
0x2BA1:001 (P718.01)	Flying restart circuit: Current	30 %	MCTRL	U16	1	P	-
0x2BA1:002 (P718.02)	Flying restart circuit: Start frequency	20.0 Hz	MCTRL	I16	10	P	-
0x2BA1:003 (P718.03)	Flying restart circuit: Restart time	5911 ms *	MCTRL	U16	1	P	-
0x2BA1:008 (P718.08)	Flying restart circuit: Flying restart frequency	x.x Hz (Read only)	MCTRL	I16	10	O	t
0x2C00 (P300.00)	Motor control mode	V/f characteristic control (VFC open loop) [6]	general	U8	1	PC	-
0x2C01:001	Motor parameters: Number of pole pairs	- (Read only)	MCTRL	U8	1	-	-
0x2C01:002	Motor parameters: Stator resistance	10.1565 Ω *	MCTRL	U32	10000	P	-
0x2C01:003	Motor parameters: Stator leakage inductance	23.566 mH *	MCTRL	U32	1000	P	-
0x2C01:004 (P320.04)	Motor parameters: Rated speed	Device for 50-Hz mains: 1450 rpm Device for 60-Hz mains: 1750 rpm	MCTRL	U16	1	P	-

* Default setting depending on the size.

Firmware version 04.00.00.00

Appendix

Parameter attribute list



Address	Name	Default setting	Category	Data type	Factor	A	M
0x2C01:005 (P320.05)	Motor parameters: Rated frequency	Device for 50-Hz mains: 50.0 Hz Device for 60-Hz mains: 60.0 Hz	MCTRL	U16	10	P	-
0x2C01:006 (P320.06)	Motor parameters: Rated power	0.25 kW *	MCTRL	U16	100	P	-
0x2C01:007 (P320.07)	Motor parameters: Rated voltage	230 V *	MCTRL	U16	1	P	-
0x2C01:008 (P320.08)	Motor parameters: Cosine phi	0.80	MCTRL	U16	100	P	-
0x2C01:010	Motor parameters: Motor name		MCTRL	STRING[25]	1	P	-
0x2C02:001 (P351.01)	Motor parameter (ASM): Rotor resistance	8.8944 Ω *	MCTRL	U32	10000	P	-
0x2C02:002 (P351.02)	Motor parameter (ASM): Mutual inductance	381.9 mH *	MCTRL	U32	10	P	-
0x2C02:003 (P351.03)	Motor parameter (ASM): Magnetising current	0.96 A *	MCTRL	U16	100	P	-
0x2C02:004 (P351.04)	Slip frequency	x.x Hz (Read only)	general	U16	10	-	-
0x2C03:001 (P352.01)	Back EMF constant	41.8 V/1000rpm	MCTRL	U32	10	P	-
0x2C11:001	High speed range: Lower limit	30 %	general	U16	1	P	-
0x2C11:002	High speed range: Tracking controller gain	200 %	general	U16	1	P	-
0x2C11:003	High speed range: Tracking controller reset time	6.00 ms	general	U16	100	P	-
0x2C11:004	High speed range: Tracking controller decouple time	200.0 ms	general	U16	10	P	-
0x2C11:006	High speed range: Stall monitoring limit	80 %	general	U16	1	P	-
0x2C12:001	SM low speed range: Acceleration current	100 %	MCTRL	U16	1	P	-
0x2C12:002	SM low speed range: Standstill current	40 %	MCTRL	U16	1	P	-
0x2C42:001 (P341.01)	Encoder settings: Increments/revolution	128	general	U32	1	PC	-
0x2C42:006	Encoder settings: Actual velocity	x rpm (Read only)	general	I32	1	O	t
0x2C42:007	Encoder settings: Status	0	general	U32	1	X	-
0x2C45 (P342.00)	Encoder-error response	Warning [1]	general	U8	1	P	-
0x2C49:001 (P711.01)	Position counter: Signal source	Disbled [0]	general	U8	1	P	-
0x2C49:002 (P711.02)	Position counter: Reset mode	Reset by rising edge [0]	general	U8	1	P	-
0x2C49:003 (P711.03)	Position counter: Actual position	- (Read only)	general	U32	1	H	t
0x2C60	PPI monitoring: Reaction	Fault [3]	general	U8	1	P	-
0x2C63:001	PPI without movement: Execution	Deactivated [0]	general	U8	1	PC	-
0x2D40:002	Device utilisation (i*t): Warning threshold	95 %	general	U16	1	P	-
0x2D40:004 (P135.04)	Device utilisation (i*t)	x % (Read only)	general	U16	1	O	t
0x2D40:005 (P135.05)	Device utilisation (i*t): Error response	Fault [3]	general	U8	1	P	-
0x2D44:001 (P350.01)	Overspeed monitoring: Threshold	8000 rpm	general	U16	1	P	-
0x2D44:002 (P350.02)	Overspeed monitoring: Response	Fault [3]	general	U8	1	P	-
0x2D45:001 (P310.01)	Motor phase failure detection: Response	No response [0]	general	U8	1	P	-
0x2D45:002 (P310.02)	Motor phase failure detection: Current threshold	5.0 %	general	U8	10	P	-
0x2D45:003 (P310.03)	Motor phase failure detection: Voltage threshold	10.0 V	general	U16	10	P	-

* Default setting depending on the size.

Firmware version 04.00.00.00

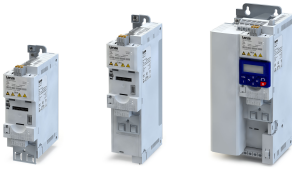

Appendix

Parameter attribute list

Address	Name	Default setting	Category	Data type	Factor	A	M
0x2D46:001 (P353.01)	Overcurrent monitoring: Threshold	6.8 A *	general	U16	10	P	-
0x2D46:002 (P353.02)	Overcurrent monitoring: Response	Fault [3]	general	U8	1	P	-
0x2D49:002 (P309.02)	Motor temperature monitoring: Response	Fault [3]	general	U8	1	P	-
0x2D48:001 (P308.01)	Motor overload monitoring (i ² *t): Maximum utilisation [60 s]	150 %	general	U16	1	P	-
0x2D48:002 (P308.02)	Motor overload monitoring (i ² *t): Speed compensation	On [0]	general	U8	1	P	-
0x2D48:003 (P308.03)	Motor overload monitoring (i ² *t): Response	Fault [3]	general	U8	1	P	-
0x2D48:005	Motor overload monitoring (i ² *t): Thermal load	- (Read only)	general	U16	1	-	-
0x2D4F (P123.00)	Motor utilisation (i ² *t)	x % (Read only)	general	U16	1	O	t
0x2D66:001 (P721.01)	Mains failure control: Enable function	Disabled [0]	general	U8	1	P	-
0x2D66:002 (P721.02)	Mains failure control: DC-bus activation level	0 % *	general	U8	1	P	-
0x2D66:003 (P721.03)	Mains failure control: Gain V-controller	0.01000 Hz/V	general	U16	100000	P	-
0x2D66:004 (P721.04)	Mains failure control: Reset time V-controller	20 ms	general	U16	1	P	-
0x2D66:005 (P721.05)	Mains failure control: DC voltage setpoint	100 %	general	U8	1	P	-
0x2D66:006 (P721.06)	Mains failure control: Setpoint ramp	20 ms	general	U16	1	P	-
0x2D66:007 (P721.07)	Mains failure control: Clear time	20 ms	general	U16	1	P	-
0x2D66:008 (P721.08)	Mains failure control: Restart threshold	0.0 Hz	general	U16	10	P	-
0x2D66:009 (P721.09)	Mains failure control: Status mains failure control	- (Read only)	general	U8	1	O	t
0x2D67:001 (P329.01)	Maximum torque monitoring: Response	No response [0]	MCTRL	U8	1	P	-
0x2D67:002 (P329.02)	Maximum torque monitoring: Triggering delay	0.000 s	MCTRL	U16	1000	P	-
0x2D81:001 (P151.01)	Life-diagnosis: Operating time	x s (Read only)	general	U32	1	T	-
0x2D81:002 (P151.02)	Life-diagnosis: Power-on time	x s (Read only)	general	U32	1	T	-
0x2D81:003 (P151.03)	Life-diagnosis: Control unit operating time	x ns (Read only)	general	U64	1	T	-
0x2D81:004 (P151.04)	Life-diagnosis: Main switching cycles	- (Read only)	general	U32	1	-	-
0x2D81:005 (P151.05)	Life-diagnosis: Relay switching cycles	- (Read only)	general	U32	1	-	-
0x2D81:006 (P151.06)	Life-diagnosis: Short-circuit counter	- (Read only)	general	U16	1	-	-
0x2D81:007 (P151.07)	Life-diagnosis: Earth fault counter	- (Read only)	general	U16	1	-	-
0x2D81:008 (P151.08)	Life-diagnosis: Clamp active	- (Read only)	general	U16	1	-	-
0x2D81:009 (P151.09)	Life-diagnosis: Fan operating time	x s (Read only)	general	U32	1	T	-
0x2D84:001 (P117.01)	Heatsink temperature	x.x °C (Read only)	general	I16	10	O	-
0x2D84:002	Heatsink temperature: Warning threshold	80.0 °C *	general	I16	10	P	-

* Default setting depending on the size.

Firmware version 04.00.00.00

Appendix

Parameter attribute list



Address	Name	Default setting	Category	Data type	Factor	A	M
0x2D87 (P105.00)	DC-bus voltage	x V (Read only)	general	U16	1	O	t
0x2D88 (P104.00)	Motor current	x.x A (Read only)	general	I16	10	O	t
0x2D89 (P106.00)	Motor voltage	x VAC (Read only)	general	U16	1	O	t
0x2DA2:001 (P108.01)	Output power: Effective power	x.xxx kW (Read only)	general	I32	1000	O	t
0x2DA2:002 (P108.02)	Output power: Apparent power	x.xxx kVA (Read only)	general	I32	1000	O	t
0x2DA3:001 (P109.01)	Output energy: Motor	x.xx kWh (Read only)	general	I32	100	O	t
0x2DA3:002 (P109.02)	Output energy: Generator	x.xx kWh (Read only)	general	I32	100	O	t
0x2DA4:001 (P110.01)	Diagnostics of analog input 1: Value in percent	x.x % (Read only)	general	I16	10	O	t
0x2DA4:002 (P110.02)	Diagnostics of analog input 1: Frequency value	x.x Hz (Read only)	general	I16	10	O	t
0x2DA4:003 (P110.03)	Diagnostics of analog input 1: Process controller value	x.xx PID unit (Read only)	general	I16	100	O	t
0x2DA4:004 (P110.04)	Diagnostics of analog input 1: Torque value	x.x % (Read only)	general	I16	10	O	t
0x2DA4:016 (P110.16)	Diagnostics of analog input 1: Status	- (Read only)	general	U16	1	O	-
0x2DA5:001 (P111.01)	Diagnostics of analog input 2: Value in percent	x.x % (Read only)	general	I16	10	O	t
0x2DA5:002 (P111.02)	Diagnostics of analog input 2: Frequency value	x.x Hz (Read only)	general	I16	10	O	t
0x2DA5:003 (P111.03)	Diagnostics of analog input 2: Process controller value	x.xx PID unit (Read only)	general	I16	100	O	t
0x2DA5:004 (P111.04)	Diagnostics of analog input 2: Torque value	x.x % (Read only)	general	I16	10	O	t
0x2DA5:016 (P111.16)	Diagnostics of analog input 2: Status	- (Read only)	general	U16	1	O	-
0x2DAA:001 (P112.01)	Diagnostics of analog output 1: Voltage	x.xx V (Read only)	general	U16	100	O	t
0x2DAA:002 (P112.02)	Diagnostics of analog output 1: Current	x.xx mA (Read only)	general	U16	100	O	t
0x2DAB:001 (P113.01)	Diagnostics of analog output 2: Voltage	x.xx V (Read only)	Appl. I/O	U16	100	O	t
0x2DAB:002 (P113.02)	Diagnostics of analog output 2: Current	x.xx mA (Read only)	Appl. I/O	U16	100	O	t
0x2DAC (P119.00)	Keypad status	- (Read only)	general	U16	1	O	t
0x2DAD (P120.00)	Internal hardware states	- (Read only)	general	U16	1	O	-
0x2DAE:001 (P140.01)	Sequencer diagnostics: Active step	- (Read only)	general	U8	1	O	t
0x2DAE:002 (P140.02)	Sequencer diagnostics: Step time elapsed	x.x s (Read only)	general	I32	10	O	t
0x2DAE:003 (P140.03)	Sequencer diagnostics: Step time remaining	x.x s (Read only)	general	I32	10	O	t
0x2DAE:004 (P140.04)	Sequencer diagnostics: Steps complete	- (Read only)	general	I32	1	O	t
0x2DAE:005 (P140.05)	Sequencer diagnostics: Steps remaining	- (Read only)	general	I32	1	O	t
0x2DAE:006 (P140.06)	Sequencer diagnostics: Active sequence	- (Read only)	general	U8	1	O	t

* Default setting depending on the size.

Firmware version 04.00.00.00



Appendix

Parameter attribute list

Address	Name	Default setting	Category	Data type	Factor	A	M
0x2DAE:007 (P140.07)	Sequencer diagnostics: Active segment	- (Read only)	general	U8	1	O	t
0x2DAE:008 (P140.08)	Sequencer diagnostics: Relative sequence time remaining	x % (Read only)	general	U8	1	O	t
0x2DAE:009 (P140.09)	Sequencer diagnostics: Absolute sequence time remaining	x.x s (Read only)	general	I32	10	O	t
0x2DAE:010	Sequencer diagnostics: Frequency setpoint	x.x Hz (Read only)	general	I16	10	-	-
0x2DAE:011	Sequencer diagnostics: PID setpoint	x.xx PID unit (Read only)	general	I16	100	-	-
0x2DAE:012	Sequencer diagnostics: Torque setpoint	x.x % (Read only)	general	I16	10	-	-
0x2DB8:001	Function list status word 1	- (Read only)	general	U32	1	I	-
0x2DB8:002	Function list status word 2	- (Read only)	general	U32	1	I	-
0x2DD3:001	Speed setpoint	x rpm (Read only)	MCTRL	I32	1	O	t
0x2DD5	Torque setpoint	x.xx Nm (Read only)	general	I32	100	-	t
0x2DDD (P100.00)	Output frequency	x.x Hz (Read only)	general	I16	10	O	t
0x2DDF:001	Axis information: Rated current	x.xx A (Read only)	general	U16	100	O	t
0x2DDF:002	Axis information: Maximum current	x.xx A (Read only)	general	U16	100	O	t
0x2EFF:001	Bootloader activation key 1	0	general	U32	1	C	-
0x2EFF:002	Bootloader activation key 2	0	general	U32	1	C	-
0x2EFF:003	Bootloader activation key 3	0	general	U32	1	C	-
0x4002 (P702.00)	Speed display scaling	0.00	general	U16	100	P	-
0x4003 (P413.00)	MOP starting mode	Last value [0]	general	U8	1	P	-
0x4004:001 (P414.01)	MOP starting values: Frequency	0.0 Hz	general	U16	10	P	-
0x4004:002 (P414.02)	MOP starting values: PID value	0.00 PID unit	general	I16	100	P	-
0x4004:003 (P414.03)	MOP starting values: Torque	0.0 %	general	U16	10	P	-
0x4005 (P412.00)	Frequency threshold	0.0 Hz	general	U16	10	P	-
0x4006:001 (P710.01)	Load loss detection: Threshold	0.0 %	general	U16	10	P	-
0x4006:002 (P710.02)	Load loss detection: Deceleration	0.0 s	general	U16	10	P	-
0x4008:001 (P590.01)	Process input words: NetWordIN1	0x0000	general	U16	1	HK	r
0x4008:002 (P590.02)	Process input words: NetWordIN2	0x0000	general	U16	1	HK	r
0x4008:003 (P590.03)	Process input words: NetWordIN3	0.0 %	general	U16	10	K	r
0x4008:004 (P590.04)	Process input words: NetWordIN4	0.0 %	general	U16	10	K	r
0x4009:001	MOP values saved: Frequency	x.x Hz (Read only)	general	U16	10	-	t
0x4009:002	MOP values saved: PID value	x.xx PID unit (Read only)	general	I16	100	-	t
0x4009:003	MOP values saved: Torque	x.x % (Read only)	general	U16	10	-	t
0x4009:004	MOP values saved: Frequency setpoint	x.x Hz (Read only)	general	I16	10	-	-
0x4009:005	MOP values saved: PID setpoint	x.xx PID unit (Read only)	general	I16	100	-	-
0x4009:006	MOP values saved: Torque setpoint	x.x % (Read only)	general	I16	10	-	-
0x400A:001 (P591.01)	Process output words: NetWordOUT1	- (Read only)	general	U16	1	H	t
0x400A:002 (P591.02)	Process output words: NetWordOUT2	- (Read only)	general	U16	1	-	t
0x400B:001 (P592.01)	Process input data: AC Drive control word	0x0000	general	U16	1	OH K	r

* Default setting depending on the size.

Firmware version 04.00.00.00

Appendix

Parameter attribute list



Address	Name	Default setting	Category	Data type	Factor	A	M
0x400B:002 (P592.02)	Process input data: LECOM control word	0x0000	general	U16	1	OH K	r
0x400B:003 (P592.03)	Process input data: Network setpoint frequency (0.1)	0.0 Hz	general	U16	10	OK	r
0x400B:004 (P592.04)	Process input data: Network setpoint speed	0 rpm	general	U16	1	OK	r
0x400B:005 (P592.05)	Process input data: Network setpoint frequency (0.01)	0.00 Hz	general	U16	100	OK	r
0x400B:006 (P592.06)	Process input data: Velocity mode setpoint	0.0 Hz	general	I16	10	OK	r
0x400B:007 (P592.07)	Process input data: PID setpoint	0.00 PID unit	general	I16	100	OK	r
0x400B:008 (P592.08)	Process input data: Torque mode setpoint	0 Nm	general	I16	1	OK	r
0x400B:009 (P592.09)	Process input data: Torque scaling	0	general	I8	1	OK	-
0x400B:010	AC Drive mode	Speed control (open loop) [1]	EtherNet/IP	U8	1	OIK	-
0x400B:011 (P592.11)	Process input data: PID feedback	0.00 PID unit	general	I16	100	OK	r
0x400B:012 (P592.12)	Process input data: Network setpoint frequency [0.02Hz]	0 Hz	general	I16	50	K	r
0x400C:001 (P593.01)	Process output data: AC Drive status word	- (Read only)	general	U16	1	-	t
0x400C:002 (P593.02)	Process output data: LECOM status word	- (Read only)	general	U16	1	-	t
0x400C:003 (P593.03)	Process output data: Frequency (0.1)	x.x Hz (Read only)	general	U16	10	-	t
0x400C:004 (P593.04)	Process output data: Motor speed	x rpm (Read only)	general	U16	1	-	t
0x400C:005 (P593.05)	Process output data: Drive status	- (Read only)	general	U16	1	-	t
0x400C:006 (P593.06)	Process output data: Frequency (0.01)	x.xx Hz (Read only)	general	U16	100	-	t
0x400C:007 (P593.07)	Process output data: Torque scaled	- (Read only)	general	I16	1	-	t
0x400C:008 (P593.08)	Process output data: Frequency [0.02 Hz]	Hz (Read only)	general	I16	50	-	t
0x400D (P101.00)	Scaled actual value	x Units (Read only)	general	I16	1	O	t
0x400E:001 (P505.01)	NetWordIN1 function: Bit 0	Not active [0]	general	U8	1	PC	-
0x400E:002 (P505.02)	NetWordIN1 function: Bit 1	Not active [0]	general	U8	1	PC	-
0x400E:003 (P505.03)	NetWordIN1 function: Bit 2	Activate quick stop [3]	general	U8	1	PC	-
0x400E:004 (P505.04)	NetWordIN1 function: Bit 3	Not active [0]	general	U8	1	PC	-
0x400E:005 (P505.05)	NetWordIN1 function: Bit 4	Run forward (CW) [8]	general	U8	1	PC	-
0x400E:006 (P505.06)	NetWordIN1 function: Bit 5	Activate preset (bit 0) [18]	general	U8	1	PC	-
0x400E:007 (P505.07)	NetWordIN1 function: Bit 6	Activate preset (bit 1) [19]	general	U8	1	PC	-
0x400E:008 (P505.08)	NetWordIN1 function: Bit 7	Reset error [4]	general	U8	1	PC	-
0x400E:009 (P505.09)	NetWordIN1 function: Bit 8	Not active [0]	general	U8	1	PC	-

* Default setting depending on the size.

Firmware version 04.00.00.00

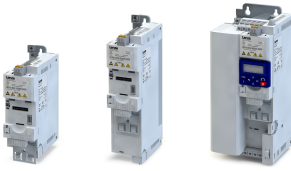

Appendix

Parameter attribute list

Address	Name	Default setting	Category	Data type	Factor	A	M
0x400E:010 (P505.10)	NetWordIN1 function: Bit 9	Activate DC braking [5]	general	U8	1	PC	-
0x400E:011 (P505.11)	NetWordIN1 function: Bit 10	Not active [0]	general	U8	1	PC	-
0x400E:012 (P505.12)	NetWordIN1 function: Bit 11	Not active [0]	general	U8	1	PC	-
0x400E:013 (P505.13)	NetWordIN1 function: Bit 12	Invert rotation [13]	general	U8	1	PC	-
0x400E:014 (P505.14)	NetWordIN1 function: Bit 13	Not active [0]	general	U8	1	PC	-
0x400E:015 (P505.15)	NetWordIN1 function: Bit 14	Not active [0]	general	U8	1	PC	-
0x400E:016 (P505.16)	NetWordIN1 function: Bit 15	Not active [0]	general	U8	1	PC	-
0x4016:003	Digital output 1: Cutout delay	0.000 s	general	U16	1000	P	-
0x4016:004	Digital output 1: Switch-on delay	0.000 s	general	U16	1000	P	-
0x4016:005	Digital output 1: Terminal state	- (Read only)	general	U8	1	-	-
0x4016:006	Digital output 1: Trigger signal state	- (Read only)	general	U8	1	-	-
0x4017:003	Digital output 2: Cutout delay	0.000 s	Appl. I/O	U16	1000	P	-
0x4017:004	Digital output 2: Switch-on delay	0.000 s	Appl. I/O	U16	1000	P	-
0x4017:005	Digital output 2: Terminal state	- (Read only)	Appl. I/O	U8	1	-	-
0x4017:006	Digital output 2: Trigger signal state	- (Read only)	Appl. I/O	U8	1	-	-
0x4018:003	Relay: Switch-off delay	0.000 s	general	U16	1000	P	-
0x4018:004	Relay: Switch-on delay	0.000 s	general	U16	1000	P	-
0x4018:005	Relay: Relay state	- (Read only)	general	U8	1	-	-
0x4018:006	Relay: Trigger signal state	- (Read only)	general	U8	1	-	-
0x4018:007	Relay: Switching cycles	- (Read only)	general	U32	1	-	-
0x401F:001 (P121.01)	Current setpoint	x.xx PID unit (Read only)	general	I16	100	O	t
0x401F:002 (P121.02)	Current process variable	x.xx PID unit (Read only)	general	I16	100	O	t
0x401F:003 (P121.03)	Status	- (Read only)	general	U8	1	O	t
0x401F:004	PID control value	x.x Hz (Read only)	general	I16	10	-	-
0x401F:005	PID Feedforward value	x.x Hz (Read only)	general	I16	10	-	-
0x401F:006	PID output value	x.x Hz (Read only)	general	I16	10	-	-
0x401F:007	PID error value	x.xx PID unit (Read only)	general	I32	100	-	-
0x4020:001 (P600.01)	Process controller setup (PID): Operating mode	Inhibited [0]	general	U8	1	P	-
0x4020:002 (P600.02)	Process controller setup (PID): PID process variable	Analog input 1 [1]	general	U8	1	P	-
0x4020:003 (P600.03)	Process controller setup (PID): Closed-loop controlled speed range	100 %	general	U16	1	P	rt
0x4020:004 (P600.04)	Process controller setup (PID): Speed feedforward control source	Without speed addition [0]	general	U8	1	P	-
0x4020:005 (P600.05)	Process controller setup (PID): Min speed limit	-100.0 %	general	I16	10	P	-
0x4020:006 (P600.06)	Process controller setup (PID): Max speed limit	100.0 %	general	I16	10	P	-
0x4021:001 (P606.01)	PID speed operation: Acceleration time	1.0 s	general	U16	10	P	-
0x4021:002 (P606.02)	PID speed operation: Deceleration time	1.0 s	general	U16	10	P	-
0x4022:001 (P451.01)	PID setpoint presets: Preset 1	0.00 PID unit	general	I16	100	P	-
0x4022:002 (P451.02)	PID setpoint presets: Preset 2	0.00 PID unit	general	I16	100	P	-

* Default setting depending on the size.

Firmware version 04.00.00.00

Appendix

Parameter attribute list



Address	Name	Default setting	Category	Data type	Factor	A	M
0x4022:003 (P451.03)	PID setpoint presets: Preset 3	0.00 PID unit	general	I16	100	P	-
0x4022:004 (P451.04)	PID setpoint presets: Preset 4	0.00 PID unit	general	I16	100	P	-
0x4022:005 (P451.05)	PID setpoint presets: Preset 5	0.00 PID unit	general	I16	100	P	-
0x4022:006 (P451.06)	PID setpoint presets: Preset 6	0.00 PID unit	general	I16	100	P	-
0x4022:007 (P451.07)	PID setpoint presets: Preset 7	0.00 PID unit	general	I16	100	P	-
0x4022:008 (P451.08)	PID setpoint presets: Preset 8	0.00 PID unit	general	I16	100	P	-
0x4023:001 (P610.01)	PID sleep mode: Activation	Disabled [0]	general	U8	1	P	-
0x4023:002 (P610.02)	PID sleep mode: Stop method	Coasting [0]	general	U8	1	P	-
0x4023:003 (P610.03)	PID sleep mode: Frequency threshold	0.0 Hz	general	U16	10	P	-
0x4023:004 (P610.04)	PID sleep mode: Feedback threshold	0.00 PID unit	general	I16	100	P	-
0x4023:005 (P610.05)	PID sleep mode: Delay time	0.0 s	general	U16	10	P	-
0x4023:006 (P610.06)	PID sleep mode: Recovery	Setpoint > threshold OR system deviation > band- width [0]	general	U8	1	P	-
0x4023:007 (P610.07)	PID sleep mode: Bandwidth	0.00 PID unit	general	U16	100	P	-
0x4023:008 (P610.08)	PID sleep mode: Recovery threshold	0.00 PID unit	general	I16	100	P	-
0x4024:001 (P615.01)	Automatic rinsing: Rinsing in idle state	Inhibited [0]	general	U8	1	P	-
0x4024:002 (P615.02)	Automatic rinsing: Rinse interval	30.0 min	general	U16	10	P	-
0x4024:003 (P615.03)	Automatic rinsing: Rinse speed	0.0 Hz	general	I16	10	P	-
0x4024:004 (P615.04)	Automatic rinsing: Rinse period	0.0 s	general	U16	10	P	-
0x4025 (P800.00)	Sequencer mode	Disabled [0]	general	U8	1	P	-
0x4026:001 (P801.01)	Sequencer segment 1: Frequency setpoint	0.0 Hz	general	I16	10	P	-
0x4026:002 (P801.02)	Sequencer segment 1: Acceleration/deceleration	5.0 s	general	U16	10	P	-
0x4026:003 (P801.03)	Sequencer segment 1: Time	0.0 s	general	U32	10	P	-
0x4026:004 (P801.04)	Sequencer segment 1: Digital outputs	0	general	U8	1	P	-
0x4026:005 (P801.05)	Sequencer segment 1: Analog outputs	0.00 VDC	general	U16	100	P	-
0x4026:006 (P801.06)	Sequencer segment 1: PID setpoint	0.00 PID unit	general	I16	100	P	-
0x4026:007 (P801.07)	Sequencer segment 1: Torque setpoint	100.0 %	general	I16	10	P	-
0x4026:008	Sequencer segment 1: NetWordOUT2	0	general	U16	1	P	-
0x4026:009	Sequencer segment 1: Position setpoint	0	general	U32	1	P	-
0x4027:001 (P802.01)	Sequencer segment 2: Frequency setpoint	0.0 Hz	general	I16	10	P	-
0x4027:002 (P802.02)	Sequencer segment 2: Acceleration/deceleration	5.0 s	general	U16	10	P	-

* Default setting depending on the size.

Firmware version 04.00.00.00

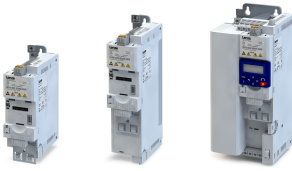

Appendix

Parameter attribute list

Address	Name	Default setting	Category	Data type	Factor	A	M
0x4027:003 (P802.03)	Sequencer segment 2: Time	0.0 s	general	U32	10	P	-
0x4027:004 (P802.04)	Sequencer segment 2: Digital outputs	0	general	U8	1	P	-
0x4027:005 (P802.05)	Sequencer segment 2: Analog outputs	0.00 VDC	general	U16	100	P	-
0x4027:006 (P802.06)	Sequencer segment 2: PID setpoint	0.00 PID unit	general	I16	100	P	-
0x4027:007 (P802.07)	Sequencer segment 2: Torque setpoint	100.0 %	general	I16	10	P	-
0x4027:008	Sequencer segment 2: NetWordOUT2	0	general	U16	1	P	-
0x4027:009	Sequencer segment 2: Position setpoint	0	general	U32	1	P	-
0x4028:001 (P803.01)	Sequencer segment 3: Frequency setpoint	0.0 Hz	general	I16	10	P	-
0x4028:002 (P803.02)	Sequencer segment 3: Acceleration/deceleration	5.0 s	general	U16	10	P	-
0x4028:003 (P803.03)	Sequencer segment 3: Time	0.0 s	general	U32	10	P	-
0x4028:004 (P803.04)	Sequencer segment 3: Digital outputs	0	general	U8	1	P	-
0x4028:005 (P803.05)	Sequencer segment 3: Analog outputs	0.00 VDC	general	U16	100	P	-
0x4028:006 (P803.06)	Sequencer segment 3: PID setpoint	0.00 PID unit	general	I16	100	P	-
0x4028:007 (P803.07)	Sequencer segment 3: Torque setpoint	100.0 %	general	I16	10	P	-
0x4028:008	Sequencer segment 3: NetWordOUT2	0	general	U16	1	P	-
0x4028:009	Sequencer segment 3: Position setpoint	0	general	U32	1	P	-
0x4029:001 (P804.01)	Sequencer segment 4: Frequency setpoint	0.0 Hz	general	I16	10	P	-
0x4029:002 (P804.02)	Sequencer segment 4: Acceleration/deceleration	5.0 s	general	U16	10	P	-
0x4029:003 (P804.03)	Sequencer segment 4: Time	0.0 s	general	U32	10	P	-
0x4029:004 (P804.04)	Sequencer segment 4: Digital outputs	0	general	U8	1	P	-
0x4029:005 (P804.05)	Sequencer segment 4: Analog outputs	0.00 VDC	general	U16	100	P	-
0x4029:006 (P804.06)	Sequencer segment 4: PID setpoint	0.00 PID unit	general	I16	100	P	-
0x4029:007 (P804.07)	Sequencer segment 4: Torque setpoint	100.0 %	general	I16	10	P	-
0x4029:008	Sequencer segment 4: NetWordOUT2	0	general	U16	1	P	-
0x4029:009	Sequencer segment 4: Position setpoint	0	general	U32	1	P	-
0x402A:001 (P805.01)	Sequencer segment 5: Frequency setpoint	0.0 Hz	general	I16	10	P	-
0x402A:002 (P805.02)	Sequencer segment 5: Acceleration/deceleration	5.0 s	general	U16	10	P	-
0x402A:003 (P805.03)	Sequencer segment 5: Time	0.0 s	general	U32	10	P	-
0x402A:004 (P805.04)	Sequencer segment 5: Digital outputs	0	general	U8	1	P	-
0x402A:005 (P805.05)	Sequencer segment 5: Analog outputs	0.00 VDC	general	U16	100	P	-
0x402A:006 (P805.06)	Sequencer segment 5: PID setpoint	0.00 PID unit	general	I16	100	P	-
0x402A:007 (P805.07)	Sequencer segment 5: Torque setpoint	100.0 %	general	I16	10	P	-
0x402A:008	Sequencer segment 5: NetWordOUT2	0	general	U16	1	P	-

* Default setting depending on the size.

Firmware version 04.00.00.00

Appendix

Parameter attribute list



Address	Name	Default setting	Category	Data type	Factor	A	M
0x402A:009	Sequencer segment 5: Position setpoint	0	general	U32	1	P	-
0x402B:001 (P806.01)	Sequencer segment 6: Frequency setpoint	0.0 Hz	general	I16	10	P	-
0x402B:002 (P806.02)	Sequencer segment 6: Acceleration/deceleration	5.0 s	general	U16	10	P	-
0x402B:003 (P806.03)	Sequencer segment 6: Time	0.0 s	general	U32	10	P	-
0x402B:004 (P806.04)	Sequencer segment 6: Digital outputs	0	general	U8	1	P	-
0x402B:005 (P806.05)	Sequencer segment 6: Analog outputs	0.00 VDC	general	U16	100	P	-
0x402B:006 (P806.06)	Sequencer segment 6: PID setpoint	0.00 PID unit	general	I16	100	P	-
0x402B:007 (P806.07)	Sequencer segment 6: Torque setpoint	100.0 %	general	I16	10	P	-
0x402B:008	Sequencer segment 6: NetWordOUT2	0	general	U16	1	P	-
0x402B:009	Sequencer segment 6: Position setpoint	0	general	U32	1	P	-
0x402C:001 (P807.01)	Sequencer segment 7: Frequency setpoint	0.0 Hz	general	I16	10	P	-
0x402C:002 (P807.02)	Sequencer segment 7: Acceleration/deceleration	5.0 s	general	U16	10	P	-
0x402C:003 (P807.03)	Sequencer segment 7: Time	0.0 s	general	U32	10	P	-
0x402C:004 (P807.04)	Sequencer segment 7: Digital outputs	0	general	U8	1	P	-
0x402C:005 (P807.05)	Sequencer segment 7: Analog outputs	0.00 VDC	general	U16	100	P	-
0x402C:006 (P807.06)	Sequencer segment 7: PID setpoint	0.00 PID unit	general	I16	100	P	-
0x402C:007 (P807.07)	Sequencer segment 7: Torque setpoint	100.0 %	general	I16	10	P	-
0x402C:008	Sequencer segment 7: NetWordOUT2	0	general	U16	1	P	-
0x402C:009	Sequencer segment 7: Position setpoint	0	general	U32	1	P	-
0x402D:001 (P808.01)	Sequencer segment 8: Frequency setpoint	0.0 Hz	general	I16	10	P	-
0x402D:002 (P808.02)	Sequencer segment 8: Acceleration/deceleration	5.0 s	general	U16	10	P	-
0x402D:003 (P808.03)	Sequencer segment 8: Time	0.0 s	general	U32	10	P	-
0x402D:004 (P808.04)	Sequencer segment 8: Digital outputs	0	general	U8	1	P	-
0x402D:005 (P808.05)	Sequencer segment 8: Analog outputs	0.00 VDC	general	U16	100	P	-
0x402D:006 (P808.06)	Sequencer segment 8: PID setpoint	0.00 PID unit	general	I16	100	P	-
0x402D:007 (P808.07)	Sequencer segment 8: Torque setpoint	100.0 %	general	I16	10	P	-
0x402D:008	Sequencer segment 8: NetWordOUT2	0	general	U16	1	P	-
0x402D:009	Sequencer segment 8: Position setpoint	0	general	U32	1	P	-
0x402E:001 (P822.01)	End segment: Frequency setpoint	0.0 Hz	general	I16	10	P	-
0x402E:002 (P822.02)	End segment: Acceleration/deceleration	5.0 s	general	U16	10	P	-
0x402E:003 (P822.03)	End segment: Time	0.0 s	general	U32	10	P	-
0x402E:004 (P822.04)	End segment: Digital outputs	0	general	U8	1	P	-
0x402E:005 (P822.05)	End segment: Analog outputs	0.00 VDC	general	U16	100	P	-

* Default setting depending on the size.

Firmware version 04.00.00.00

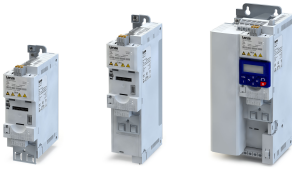

Appendix

Parameter attribute list

Address	Name	Default setting	Category	Data type	Factor	A	M
0x402E:006 (P822.06)	End segment: PID setpoint	0.00 PID unit	general	I16	100	P	-
0x402E:007 (P822.07)	End segment: Torque setpoint	100.0 %	general	I16	10	P	-
0x402E:008	End segment: NetWordOUT2	0	general	U16	1	P	-
0x402E:009	End segment: Position setpoint	0	general	U32	1	P	-
0x402F (P824.00)	End of sequence mode	Keep running [0]	general	U8	1	P	-
0x4030:001 (P830.01)	Sequence 1: Step 1	Skip step [0]	general	I8	1	P	-
0x4030:002 (P830.02)	Sequence 1: Step 2	Skip step [0]	general	I8	1	P	-
0x4030:003 (P830.03)	Sequence 1: Step 3	Skip step [0]	general	I8	1	P	-
0x4030:004 (P830.04)	Sequence 1: Step 4	Skip step [0]	general	I8	1	P	-
0x4030:005 (P830.05)	Sequence 1: Step 5	Skip step [0]	general	I8	1	P	-
0x4030:006 (P830.06)	Sequence 1: Step 6	Skip step [0]	general	I8	1	P	-
0x4030:007 (P830.07)	Sequence 1: Step 7	Skip step [0]	general	I8	1	P	-
0x4030:008 (P830.08)	Sequence 1: Step 8	Skip step [0]	general	I8	1	P	-
0x4030:009 (P830.09)	Sequence 1: Step 9	Skip step [0]	general	I8	1	P	-
0x4030:010 (P830.10)	Sequence 1: Step 10	Skip step [0]	general	I8	1	P	-
0x4030:011 (P830.11)	Sequence 1: Step 11	Skip step [0]	general	I8	1	P	-
0x4030:012 (P830.12)	Sequence 1: Step 12	Skip step [0]	general	I8	1	P	-
0x4030:013 (P830.13)	Sequence 1: Step 13	Skip step [0]	general	I8	1	P	-
0x4030:014 (P830.14)	Sequence 1: Step 14	Skip step [0]	general	I8	1	P	-
0x4030:015 (P830.15)	Sequence 1: Step 15	Skip step [0]	general	I8	1	P	-
0x4030:016 (P830.16)	Sequence 1: Step 16	Skip step [0]	general	I8	1	P	-
0x4031 (P831.00)	Number of cycles sequence 1	1	general	U16	1	P	-
0x4032:001 (P835.01)	Sequence 2: Step 1	Skip step [0]	general	I8	1	P	-
0x4032:002 (P835.02)	Sequence 2: Step 2	Skip step [0]	general	I8	1	P	-
0x4032:003 (P835.03)	Sequence 2: Step 3	Skip step [0]	general	I8	1	P	-
0x4032:004 (P835.04)	Sequence 2: Step 4	Skip step [0]	general	I8	1	P	-
0x4032:005 (P835.05)	Sequence 2: Step 5	Skip step [0]	general	I8	1	P	-
0x4032:006 (P835.06)	Sequence 2: Step 6	Skip step [0]	general	I8	1	P	-
0x4032:007 (P835.07)	Sequence 2: Step 7	Skip step [0]	general	I8	1	P	-
0x4032:008 (P835.08)	Sequence 2: Step 8	Skip step [0]	general	I8	1	P	-

* Default setting depending on the size.

Firmware version 04.00.00.00

Appendix

Parameter attribute list



Address	Name	Default setting	Category	Data type	Factor	A	M
0x4032:009 (P835.09)	Sequence 2: Step 9	Skip step [0]	general	I8	1	P	-
0x4032:010 (P835.10)	Sequence 2: Step 10	Skip step [0]	general	I8	1	P	-
0x4032:011 (P835.11)	Sequence 2: Step 11	Skip step [0]	general	I8	1	P	-
0x4032:012 (P835.12)	Sequence 2: Step 12	Skip step [0]	general	I8	1	P	-
0x4032:013 (P835.13)	Sequence 2: Step 13	Skip step [0]	general	I8	1	P	-
0x4032:014 (P835.14)	Sequence 2: Step 14	Skip step [0]	general	I8	1	P	-
0x4032:015 (P835.15)	Sequence 2: Step 15	Skip step [0]	general	I8	1	P	-
0x4032:016 (P835.16)	Sequence 2: Step 16	Skip step [0]	general	I8	1	P	-
0x4033 (P836.00)	Number of cycles sequence 2	1	general	U16	1	P	-
0x4034:001 (P840.01)	Sequence 3: Step 1	Skip step [0]	general	I8	1	P	-
0x4034:002 (P840.02)	Sequence 3: Step 2	Skip step [0]	general	I8	1	P	-
0x4034:003 (P840.03)	Sequence 3: Step 3	Skip step [0]	general	I8	1	P	-
0x4034:004 (P840.04)	Sequence 3: Step 4	Skip step [0]	general	I8	1	P	-
0x4034:005 (P840.05)	Sequence 3: Step 5	Skip step [0]	general	I8	1	P	-
0x4034:006 (P840.06)	Sequence 3: Step 6	Skip step [0]	general	I8	1	P	-
0x4034:007 (P840.07)	Sequence 3: Step 7	Skip step [0]	general	I8	1	P	-
0x4034:008 (P840.08)	Sequence 3: Step 8	Skip step [0]	general	I8	1	P	-
0x4034:009 (P840.09)	Sequence 3: Step 9	Skip step [0]	general	I8	1	P	-
0x4034:010 (P840.10)	Sequence 3: Step 10	Skip step [0]	general	I8	1	P	-
0x4034:011 (P840.11)	Sequence 3: Step 11	Skip step [0]	general	I8	1	P	-
0x4034:012 (P840.12)	Sequence 3: Step 12	Skip step [0]	general	I8	1	P	-
0x4034:013 (P840.13)	Sequence 3: Step 13	Skip step [0]	general	I8	1	P	-
0x4034:014 (P840.14)	Sequence 3: Step 14	Skip step [0]	general	I8	1	P	-
0x4034:015 (P840.15)	Sequence 3: Step 15	Skip step [0]	general	I8	1	P	-
0x4034:016 (P840.16)	Sequence 3: Step 16	Skip step [0]	general	I8	1	P	-
0x4035 (P841.00)	Number of cycles sequence 3	1	general	U16	1	P	-
0x4036:001 (P845.01)	Sequence 4: Step 1	Skip step [0]	general	I8	1	P	-
0x4036:002 (P845.02)	Sequence 4: Step 2	Skip step [0]	general	I8	1	P	-
0x4036:003 (P845.03)	Sequence 4: Step 3	Skip step [0]	general	I8	1	P	-

* Default setting depending on the size.

Firmware version 04.00.00.00

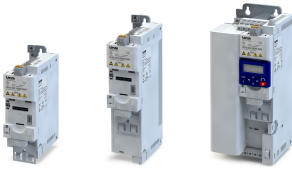

Appendix

Parameter attribute list

Address	Name	Default setting	Category	Data type	Factor	A	M
0x4036:004 (P845.04)	Sequence 4: Step 4	Skip step [0]	general	I8	1	P	-
0x4036:005 (P845.05)	Sequence 4: Step 5	Skip step [0]	general	I8	1	P	-
0x4036:006 (P845.06)	Sequence 4: Step 6	Skip step [0]	general	I8	1	P	-
0x4036:007 (P845.07)	Sequence 4: Step 7	Skip step [0]	general	I8	1	P	-
0x4036:008 (P845.08)	Sequence 4: Step 8	Skip step [0]	general	I8	1	P	-
0x4036:009 (P845.09)	Sequence 4: Step 9	Skip step [0]	general	I8	1	P	-
0x4036:010 (P845.10)	Sequence 4: Step 10	Skip step [0]	general	I8	1	P	-
0x4036:011 (P845.11)	Sequence 4: Step 11	Skip step [0]	general	I8	1	P	-
0x4036:012 (P845.12)	Sequence 4: Step 12	Skip step [0]	general	I8	1	P	-
0x4036:013 (P845.13)	Sequence 4: Step 13	Skip step [0]	general	I8	1	P	-
0x4036:014 (P845.14)	Sequence 4: Step 14	Skip step [0]	general	I8	1	P	-
0x4036:015 (P845.15)	Sequence 4: Step 15	Skip step [0]	general	I8	1	P	-
0x4036:016 (P845.16)	Sequence 4: Step 16	Skip step [0]	general	I8	1	P	-
0x4037 (P846.00)	Number of cycles sequence 4	1	general	U16	1	P	-
0x4038:001 (P850.01)	Sequence 5: Step 1	Skip step [0]	general	I8	1	P	-
0x4038:002 (P850.02)	Sequence 5: Step 2	Skip step [0]	general	I8	1	P	-
0x4038:003 (P850.03)	Sequence 5: Step 3	Skip step [0]	general	I8	1	P	-
0x4038:004 (P850.04)	Sequence 5: Step 4	Skip step [0]	general	I8	1	P	-
0x4038:005 (P850.05)	Sequence 5: Step 5	Skip step [0]	general	I8	1	P	-
0x4038:006 (P850.06)	Sequence 5: Step 6	Skip step [0]	general	I8	1	P	-
0x4038:007 (P850.07)	Sequence 5: Step 7	Skip step [0]	general	I8	1	P	-
0x4038:008 (P850.08)	Sequence 5: Step 8	Skip step [0]	general	I8	1	P	-
0x4038:009 (P850.09)	Sequence 5: Step 9	Skip step [0]	general	I8	1	P	-
0x4038:010 (P850.10)	Sequence 5: Step 10	Skip step [0]	general	I8	1	P	-
0x4038:011 (P850.11)	Sequence 5: Step 11	Skip step [0]	general	I8	1	P	-
0x4038:012 (P850.12)	Sequence 5: Step 12	Skip step [0]	general	I8	1	P	-
0x4038:013 (P850.13)	Sequence 5: Step 13	Skip step [0]	general	I8	1	P	-
0x4038:014 (P850.14)	Sequence 5: Step 14	Skip step [0]	general	I8	1	P	-
0x4038:015 (P850.15)	Sequence 5: Step 15	Skip step [0]	general	I8	1	P	-

* Default setting depending on the size.

Firmware version 04.00.00.00

Appendix

Parameter attribute list



Address	Name	Default setting	Category	Data type	Factor	A	M
0x4038:016 (P850.16)	Sequence 5: Step 16	Skip step [0]	general	I8	1	P	-
0x4039 (P851.00)	Number of cycles sequence 5	1	general	U16	1	P	-
0x403A:001 (P855.01)	Sequence 6: Step 1	Skip step [0]	general	I8	1	P	-
0x403A:002 (P855.02)	Sequence 6: Step 2	Skip step [0]	general	I8	1	P	-
0x403A:003 (P855.03)	Sequence 6: Step 3	Skip step [0]	general	I8	1	P	-
0x403A:004 (P855.04)	Sequence 6: Step 4	Skip step [0]	general	I8	1	P	-
0x403A:005 (P855.05)	Sequence 6: Step 5	Skip step [0]	general	I8	1	P	-
0x403A:006 (P855.06)	Sequence 6: Step 6	Skip step [0]	general	I8	1	P	-
0x403A:007 (P855.07)	Sequence 6: Step 7	Skip step [0]	general	I8	1	P	-
0x403A:008 (P855.08)	Sequence 6: Step 8	Skip step [0]	general	I8	1	P	-
0x403A:009 (P855.09)	Sequence 6: Step 9	Skip step [0]	general	I8	1	P	-
0x403A:010 (P855.10)	Sequence 6: Step 10	Skip step [0]	general	I8	1	P	-
0x403A:011 (P855.11)	Sequence 6: Step 11	Skip step [0]	general	I8	1	P	-
0x403A:012 (P855.12)	Sequence 6: Step 12	Skip step [0]	general	I8	1	P	-
0x403A:013 (P855.13)	Sequence 6: Step 13	Skip step [0]	general	I8	1	P	-
0x403A:014 (P855.14)	Sequence 6: Step 14	Skip step [0]	general	I8	1	P	-
0x403A:015 (P855.15)	Sequence 6: Step 15	Skip step [0]	general	I8	1	P	-
0x403A:016 (P855.16)	Sequence 6: Step 16	Skip step [0]	general	I8	1	P	-
0x403B (P856.00)	Number of cycles sequence 6	1	general	U16	1	P	-
0x403C:001 (P860.01)	Sequence 7: Step 1	Skip step [0]	general	I8	1	P	-
0x403C:002 (P860.02)	Sequence 7: Step 2	Skip step [0]	general	I8	1	P	-
0x403C:003 (P860.03)	Sequence 7: Step 3	Skip step [0]	general	I8	1	P	-
0x403C:004 (P860.04)	Sequence 7: Step 4	Skip step [0]	general	I8	1	P	-
0x403C:005 (P860.05)	Sequence 7: Step 5	Skip step [0]	general	I8	1	P	-
0x403C:006 (P860.06)	Sequence 7: Step 6	Skip step [0]	general	I8	1	P	-
0x403C:007 (P860.07)	Sequence 7: Step 7	Skip step [0]	general	I8	1	P	-
0x403C:008 (P860.08)	Sequence 7: Step 8	Skip step [0]	general	I8	1	P	-
0x403C:009 (P860.09)	Sequence 7: Step 9	Skip step [0]	general	I8	1	P	-
0x403C:010 (P860.10)	Sequence 7: Step 10	Skip step [0]	general	I8	1	P	-
* Default setting depending on the size.					Firmware version 04.00.00.00		

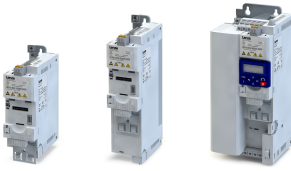

Appendix

Parameter attribute list

Address	Name	Default setting	Category	Data type	Factor	A	M
0x403C:011 (P860.11)	Sequence 7: Step 11	Skip step [0]	general	I8	1	P	-
0x403C:012 (P860.12)	Sequence 7: Step 12	Skip step [0]	general	I8	1	P	-
0x403C:013 (P860.13)	Sequence 7: Step 13	Skip step [0]	general	I8	1	P	-
0x403C:014 (P860.14)	Sequence 7: Step 14	Skip step [0]	general	I8	1	P	-
0x403C:015 (P860.15)	Sequence 7: Step 15	Skip step [0]	general	I8	1	P	-
0x403C:016 (P860.16)	Sequence 7: Step 16	Skip step [0]	general	I8	1	P	-
0x403D (P861.00)	Number of cycles sequence 7	1	general	U16	1	P	-
0x403E:001 (P865.01)	Sequence 8: Step 1	Skip step [0]	general	I8	1	P	-
0x403E:002 (P865.02)	Sequence 8: Step 2	Skip step [0]	general	I8	1	P	-
0x403E:003 (P865.03)	Sequence 8: Step 3	Skip step [0]	general	I8	1	P	-
0x403E:004 (P865.04)	Sequence 8: Step 4	Skip step [0]	general	I8	1	P	-
0x403E:005 (P865.05)	Sequence 8: Step 5	Skip step [0]	general	I8	1	P	-
0x403E:006 (P865.06)	Sequence 8: Step 6	Skip step [0]	general	I8	1	P	-
0x403E:007 (P865.07)	Sequence 8: Step 7	Skip step [0]	general	I8	1	P	-
0x403E:008 (P865.08)	Sequence 8: Step 8	Skip step [0]	general	I8	1	P	-
0x403E:009 (P865.09)	Sequence 8: Step 9	Skip step [0]	general	I8	1	P	-
0x403E:010 (P865.10)	Sequence 8: Step 10	Skip step [0]	general	I8	1	P	-
0x403E:011 (P865.11)	Sequence 8: Step 11	Skip step [0]	general	I8	1	P	-
0x403E:012 (P865.12)	Sequence 8: Step 12	Skip step [0]	general	I8	1	P	-
0x403E:013 (P865.13)	Sequence 8: Step 13	Skip step [0]	general	I8	1	P	-
0x403E:014 (P865.14)	Sequence 8: Step 14	Skip step [0]	general	I8	1	P	-
0x403E:015 (P865.15)	Sequence 8: Step 15	Skip step [0]	general	I8	1	P	-
0x403E:016 (P865.16)	Sequence 8: Step 16	Skip step [0]	general	I8	1	P	-
0x403F (P866.00)	Number of cycles sequence 8	1	general	U16	1	P	-
0x4040 (P820.00)	Start of sequence mode	Restart sequencer [0]	general	U8	1	P	-
0x4041:001 (P750.01)	Parameter change-over: Parameter 1	0x00000000	general	IDX	1	PH	-
0x4041:002 (P750.02)	Parameter change-over: Parameter 2	0x00000000	general	IDX	1	PH	-
0x4041:003 (P750.03)	Parameter change-over: Parameter 3	0x00000000	general	IDX	1	PH	-
0x4041:004 (P750.04)	Parameter change-over: Parameter 4	0x00000000	general	IDX	1	PH	-

* Default setting depending on the size.

Firmware version 04.00.00.00

Appendix

Parameter attribute list



Address	Name	Default setting	Category	Data type	Factor	A	M
0x4041:005 (P750.05)	Parameter change-over: Parameter 5	0x00000000	general	IDX	1	PH	-
0x4041:006 (P750.06)	Parameter change-over: Parameter 6	0x00000000	general	IDX	1	PH	-
0x4041:007 (P750.07)	Parameter change-over: Parameter 7	0x00000000	general	IDX	1	PH	-
0x4041:008 (P750.08)	Parameter change-over: Parameter 8	0x00000000	general	IDX	1	PH	-
0x4041:009 (P750.09)	Parameter change-over: Parameter 9	0x00000000	general	IDX	1	PH	-
0x4041:010 (P750.10)	Parameter change-over: Parameter 10	0x00000000	general	IDX	1	PH	-
0x4041:011 (P750.11)	Parameter change-over: Parameter 11	0x00000000	general	IDX	1	PH	-
0x4041:012 (P750.12)	Parameter change-over: Parameter 12	0x00000000	general	IDX	1	PH	-
0x4041:013 (P750.13)	Parameter change-over: Parameter 13	0x00000000	general	IDX	1	PH	-
0x4041:014 (P750.14)	Parameter change-over: Parameter 14	0x00000000	general	IDX	1	PH	-
0x4041:015 (P750.15)	Parameter change-over: Parameter 15	0x00000000	general	IDX	1	PH	-
0x4041:016 (P750.16)	Parameter change-over: Parameter 16	0x00000000	general	IDX	1	PH	-
0x4041:017 (P750.17)	Parameter change-over: Parameter 17	0x00000000	general	IDX	1	PH	-
0x4041:018 (P750.18)	Parameter change-over: Parameter 18	0x00000000	general	IDX	1	PH	-
0x4041:019 (P750.19)	Parameter change-over: Parameter 19	0x00000000	general	IDX	1	PH	-
0x4041:020 (P750.20)	Parameter change-over: Parameter 20	0x00000000	general	IDX	1	PH	-
0x4041:021 (P750.21)	Parameter change-over: Parameter 21	0x00000000	general	IDX	1	PH	-
0x4041:022 (P750.22)	Parameter change-over: Parameter 22	0x00000000	general	IDX	1	PH	-
0x4041:023 (P750.23)	Parameter change-over: Parameter 23	0x00000000	general	IDX	1	PH	-
0x4041:024 (P750.24)	Parameter change-over: Parameter 24	0x00000000	general	IDX	1	PH	-
0x4041:025 (P750.25)	Parameter change-over: Parameter 25	0x00000000	general	IDX	1	PH	-
0x4041:026 (P750.26)	Parameter change-over: Parameter 26	0x00000000	general	IDX	1	PH	-
0x4041:027 (P750.27)	Parameter change-over: Parameter 27	0x00000000	general	IDX	1	PH	-
0x4041:028 (P750.28)	Parameter change-over: Parameter 28	0x00000000	general	IDX	1	PH	-
0x4041:029 (P750.29)	Parameter change-over: Parameter 29	0x00000000	general	IDX	1	PH	-
0x4041:030 (P750.30)	Parameter change-over: Parameter 30	0x00000000	general	IDX	1	PH	-
0x4041:031 (P750.31)	Parameter change-over: Parameter 31	0x00000000	general	IDX	1	PH	-
0x4041:032 (P750.32)	Parameter change-over: Parameter 32	0x00000000	general	IDX	1	PH	-
0x4042:001 (P751.01)	Parameter value set 1: Value of parameter 1	0	general	I32	1	P	-

* Default setting depending on the size.

Firmware version 04.00.00.00

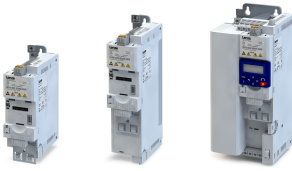

Appendix

Parameter attribute list

Address	Name	Default setting	Category	Data type	Factor	A	M
0x4042:002 (P751.02)	Parameter value set 1: Value of parameter 2	0	general	I32	1	P	-
0x4042:003 (P751.03)	Parameter value set 1: Value of parameter 3	0	general	I32	1	P	-
0x4042:004 (P751.04)	Parameter value set 1: Value of parameter 4	0	general	I32	1	P	-
0x4042:005 (P751.05)	Parameter value set 1: Value of parameter 5	0	general	I32	1	P	-
0x4042:006 (P751.06)	Parameter value set 1: Value of parameter 6	0	general	I32	1	P	-
0x4042:007 (P751.07)	Parameter value set 1: Value of parameter 7	0	general	I32	1	P	-
0x4042:008 (P751.08)	Parameter value set 1: Value of parameter 8	0	general	I32	1	P	-
0x4042:009 (P751.09)	Parameter value set 1: Value of parameter 9	0	general	I32	1	P	-
0x4042:010 (P751.10)	Parameter value set 1: Value of parameter 10	0	general	I32	1	P	-
0x4042:011 (P751.11)	Parameter value set 1: Value of parameter 11	0	general	I32	1	P	-
0x4042:012 (P751.12)	Parameter value set 1: Value of parameter 12	0	general	I32	1	P	-
0x4042:013 (P751.13)	Parameter value set 1: Value of parameter 13	0	general	I32	1	P	-
0x4042:014 (P751.14)	Parameter value set 1: Value of parameter 14	0	general	I32	1	P	-
0x4042:015 (P751.15)	Parameter value set 1: Value of parameter 15	0	general	I32	1	P	-
0x4042:016 (P751.16)	Parameter value set 1: Value of parameter 16	0	general	I32	1	P	-
0x4042:017 (P751.17)	Parameter value set 1: Value of parameter 17	0	general	I32	1	P	-
0x4042:018 (P751.18)	Parameter value set 1: Value of parameter 18	0	general	I32	1	P	-
0x4042:019 (P751.19)	Parameter value set 1: Value of parameter 19	0	general	I32	1	P	-
0x4042:020 (P751.20)	Parameter value set 1: Value of parameter 20	0	general	I32	1	P	-
0x4042:021 (P751.21)	Parameter value set 1: Value of parameter 21	0	general	I32	1	P	-
0x4042:022 (P751.22)	Parameter value set 1: Value of parameter 22	0	general	I32	1	P	-
0x4042:023 (P751.23)	Parameter value set 1: Value of parameter 23	0	general	I32	1	P	-
0x4042:024 (P751.24)	Parameter value set 1: Value of parameter 24	0	general	I32	1	P	-
0x4042:025 (P751.25)	Parameter value set 1: Value of parameter 25	0	general	I32	1	P	-
0x4042:026 (P751.26)	Parameter value set 1: Value of parameter 26	0	general	I32	1	P	-
0x4042:027 (P751.27)	Parameter value set 1: Value of parameter 27	0	general	I32	1	P	-
0x4042:028 (P751.28)	Parameter value set 1: Value of parameter 28	0	general	I32	1	P	-
0x4042:029 (P751.29)	Parameter value set 1: Value of parameter 29	0	general	I32	1	P	-
0x4042:030 (P751.30)	Parameter value set 1: Value of parameter 30	0	general	I32	1	P	-

* Default setting depending on the size.

Firmware version 04.00.00.00

Appendix

Parameter attribute list



Address	Name	Default setting	Category	Data type	Factor	A	M
0x4042:031 (P751.31)	Parameter value set 1: Value of parameter 31	0	general	I32	1	P	-
0x4042:032 (P751.32)	Parameter value set 1: Value of parameter 32	0	general	I32	1	P	-
0x4043:001 (P752.01)	Parameter value set 2: Value of parameter 1	0	general	I32	1	P	-
0x4043:002 (P752.02)	Parameter value set 2: Value of parameter 2	0	general	I32	1	P	-
0x4043:003 (P752.03)	Parameter value set 2: Value of parameter 3	0	general	I32	1	P	-
0x4043:004 (P752.04)	Parameter value set 2: Value of parameter 4	0	general	I32	1	P	-
0x4043:005 (P752.05)	Parameter value set 2: Value of parameter 5	0	general	I32	1	P	-
0x4043:006 (P752.06)	Parameter value set 2: Value of parameter 6	0	general	I32	1	P	-
0x4043:007 (P752.07)	Parameter value set 2: Value of parameter 7	0	general	I32	1	P	-
0x4043:008 (P752.08)	Parameter value set 2: Value of parameter 8	0	general	I32	1	P	-
0x4043:009 (P752.09)	Parameter value set 2: Value of parameter 9	0	general	I32	1	P	-
0x4043:010 (P752.10)	Parameter value set 2: Value of parameter 10	0	general	I32	1	P	-
0x4043:011 (P752.11)	Parameter value set 2: Value of parameter 11	0	general	I32	1	P	-
0x4043:012 (P752.12)	Parameter value set 2: Value of parameter 12	0	general	I32	1	P	-
0x4043:013 (P752.13)	Parameter value set 2: Value of parameter 13	0	general	I32	1	P	-
0x4043:014 (P752.14)	Parameter value set 2: Value of parameter 14	0	general	I32	1	P	-
0x4043:015 (P752.15)	Parameter value set 2: Value of parameter 15	0	general	I32	1	P	-
0x4043:016 (P752.16)	Parameter value set 2: Value of parameter 16	0	general	I32	1	P	-
0x4043:017 (P752.17)	Parameter value set 2: Value of parameter 17	0	general	I32	1	P	-
0x4043:018 (P752.18)	Parameter value set 2: Value of parameter 18	0	general	I32	1	P	-
0x4043:019 (P752.19)	Parameter value set 2: Value of parameter 19	0	general	I32	1	P	-
0x4043:020 (P752.20)	Parameter value set 2: Value of parameter 20	0	general	I32	1	P	-
0x4043:021 (P752.21)	Parameter value set 2: Value of parameter 21	0	general	I32	1	P	-
0x4043:022 (P752.22)	Parameter value set 2: Value of parameter 22	0	general	I32	1	P	-
0x4043:023 (P752.23)	Parameter value set 2: Value of parameter 23	0	general	I32	1	P	-
0x4043:024 (P752.24)	Parameter value set 2: Value of parameter 24	0	general	I32	1	P	-
0x4043:025 (P752.25)	Parameter value set 2: Value of parameter 25	0	general	I32	1	P	-
0x4043:026 (P752.26)	Parameter value set 2: Value of parameter 26	0	general	I32	1	P	-
0x4043:027 (P752.27)	Parameter value set 2: Value of parameter 27	0	general	I32	1	P	-

* Default setting depending on the size.

Firmware version 04.00.00.00



Appendix

Parameter attribute list

Address	Name	Default setting	Category	Data type	Factor	A	M
0x4043:028 (P752.28)	Parameter value set 2: Value of parameter 28	0	general	I32	1	P	-
0x4043:029 (P752.29)	Parameter value set 2: Value of parameter 29	0	general	I32	1	P	-
0x4043:030 (P752.30)	Parameter value set 2: Value of parameter 30	0	general	I32	1	P	-
0x4043:031 (P752.31)	Parameter value set 2: Value of parameter 31	0	general	I32	1	P	-
0x4043:032 (P752.32)	Parameter value set 2: Value of parameter 32	0	general	I32	1	P	-
0x4044:001 (P753.01)	Parameter value set 3: Value of parameter 1	0	general	I32	1	P	-
0x4044:002 (P753.02)	Parameter value set 3: Value of parameter 2	0	general	I32	1	P	-
0x4044:003 (P753.03)	Parameter value set 3: Value of parameter 3	0	general	I32	1	P	-
0x4044:004 (P753.04)	Parameter value set 3: Value of parameter 4	0	general	I32	1	P	-
0x4044:005 (P753.05)	Parameter value set 3: Value of parameter 5	0	general	I32	1	P	-
0x4044:006 (P753.06)	Parameter value set 3: Value of parameter 6	0	general	I32	1	P	-
0x4044:007 (P753.07)	Parameter value set 3: Value of parameter 7	0	general	I32	1	P	-
0x4044:008 (P753.08)	Parameter value set 3: Value of parameter 8	0	general	I32	1	P	-
0x4044:009 (P753.09)	Parameter value set 3: Value of parameter 9	0	general	I32	1	P	-
0x4044:010 (P753.10)	Parameter value set 3: Value of parameter 10	0	general	I32	1	P	-
0x4044:011 (P753.11)	Parameter value set 3: Value of parameter 11	0	general	I32	1	P	-
0x4044:012 (P753.12)	Parameter value set 3: Value of parameter 12	0	general	I32	1	P	-
0x4044:013 (P753.13)	Parameter value set 3: Value of parameter 13	0	general	I32	1	P	-
0x4044:014 (P753.14)	Parameter value set 3: Value of parameter 14	0	general	I32	1	P	-
0x4044:015 (P753.15)	Parameter value set 3: Value of parameter 15	0	general	I32	1	P	-
0x4044:016 (P753.16)	Parameter value set 3: Value of parameter 16	0	general	I32	1	P	-
0x4044:017 (P753.17)	Parameter value set 3: Value of parameter 17	0	general	I32	1	P	-
0x4044:018 (P753.18)	Parameter value set 3: Value of parameter 18	0	general	I32	1	P	-
0x4044:019 (P753.19)	Parameter value set 3: Value of parameter 19	0	general	I32	1	P	-
0x4044:020 (P753.20)	Parameter value set 3: Value of parameter 20	0	general	I32	1	P	-
0x4044:021 (P753.21)	Parameter value set 3: Value of parameter 21	0	general	I32	1	P	-
0x4044:022 (P753.22)	Parameter value set 3: Value of parameter 22	0	general	I32	1	P	-
0x4044:023 (P753.23)	Parameter value set 3: Value of parameter 23	0	general	I32	1	P	-
0x4044:024 (P753.24)	Parameter value set 3: Value of parameter 24	0	general	I32	1	P	-

* Default setting depending on the size.

Firmware version 04.00.00.00

Appendix

Parameter attribute list



Address	Name	Default setting	Category	Data type	Factor	A	M
0x4044:025 (P753.25)	Parameter value set 3: Value of parameter 25	0	general	l32	1	P	-
0x4044:026 (P753.26)	Parameter value set 3: Value of parameter 26	0	general	l32	1	P	-
0x4044:027 (P753.27)	Parameter value set 3: Value of parameter 27	0	general	l32	1	P	-
0x4044:028 (P753.28)	Parameter value set 3: Value of parameter 28	0	general	l32	1	P	-
0x4044:029 (P753.29)	Parameter value set 3: Value of parameter 29	0	general	l32	1	P	-
0x4044:030 (P753.30)	Parameter value set 3: Value of parameter 30	0	general	l32	1	P	-
0x4044:031 (P753.31)	Parameter value set 3: Value of parameter 31	0	general	l32	1	P	-
0x4044:032 (P753.32)	Parameter value set 3: Value of parameter 32	0	general	l32	1	P	-
0x4045:001 (P754.01)	Parameter value set 4: Value of parameter 1	0	general	l32	1	P	-
0x4045:002 (P754.02)	Parameter value set 4: Value of parameter 2	0	general	l32	1	P	-
0x4045:003 (P754.03)	Parameter value set 4: Value of parameter 3	0	general	l32	1	P	-
0x4045:004 (P754.04)	Parameter value set 4: Value of parameter 4	0	general	l32	1	P	-
0x4045:005 (P754.05)	Parameter value set 4: Value of parameter 5	0	general	l32	1	P	-
0x4045:006 (P754.06)	Parameter value set 4: Value of parameter 6	0	general	l32	1	P	-
0x4045:007 (P754.07)	Parameter value set 4: Value of parameter 7	0	general	l32	1	P	-
0x4045:008 (P754.08)	Parameter value set 4: Value of parameter 8	0	general	l32	1	P	-
0x4045:009 (P754.09)	Parameter value set 4: Value of parameter 9	0	general	l32	1	P	-
0x4045:010 (P754.10)	Parameter value set 4: Value of parameter 10	0	general	l32	1	P	-
0x4045:011 (P754.11)	Parameter value set 4: Value of parameter 11	0	general	l32	1	P	-
0x4045:012 (P754.12)	Parameter value set 4: Value of parameter 12	0	general	l32	1	P	-
0x4045:013 (P754.13)	Parameter value set 4: Value of parameter 13	0	general	l32	1	P	-
0x4045:014 (P754.14)	Parameter value set 4: Value of parameter 14	0	general	l32	1	P	-
0x4045:015 (P754.15)	Parameter value set 4: Value of parameter 15	0	general	l32	1	P	-
0x4045:016 (P754.16)	Parameter value set 4: Value of parameter 16	0	general	l32	1	P	-
0x4045:017 (P754.17)	Parameter value set 4: Value of parameter 17	0	general	l32	1	P	-
0x4045:018 (P754.18)	Parameter value set 4: Value of parameter 18	0	general	l32	1	P	-
0x4045:019 (P754.19)	Parameter value set 4: Value of parameter 19	0	general	l32	1	P	-
0x4045:020 (P754.20)	Parameter value set 4: Value of parameter 20	0	general	l32	1	P	-
0x4045:021 (P754.21)	Parameter value set 4: Value of parameter 21	0	general	l32	1	P	-

* Default setting depending on the size.

Firmware version 04.00.00.00

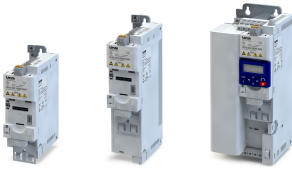

Appendix

Parameter attribute list

Address	Name	Default setting	Category	Data type	Factor	A	M
0x4045:022 (P754.22)	Parameter value set 4: Value of parameter 22	0	general	I32	1	P	-
0x4045:023 (P754.23)	Parameter value set 4: Value of parameter 23	0	general	I32	1	P	-
0x4045:024 (P754.24)	Parameter value set 4: Value of parameter 24	0	general	I32	1	P	-
0x4045:025 (P754.25)	Parameter value set 4: Value of parameter 25	0	general	I32	1	P	-
0x4045:026 (P754.26)	Parameter value set 4: Value of parameter 26	0	general	I32	1	P	-
0x4045:027 (P754.27)	Parameter value set 4: Value of parameter 27	0	general	I32	1	P	-
0x4045:028 (P754.28)	Parameter value set 4: Value of parameter 28	0	general	I32	1	P	-
0x4045:029 (P754.29)	Parameter value set 4: Value of parameter 29	0	general	I32	1	P	-
0x4045:030 (P754.30)	Parameter value set 4: Value of parameter 30	0	general	I32	1	P	-
0x4045:031 (P754.31)	Parameter value set 4: Value of parameter 31	0	general	I32	1	P	-
0x4045:032 (P754.32)	Parameter value set 4: Value of parameter 32	0	general	I32	1	P	-
0x4046 (P755.00)	Activation of parameter set	Via command (disable required) [0]	general	U8	1	P	-
0x4047:001 (P756.01)	Parameter change-over error message: Status	- (Read only)	general	U16	1	-	-
0x4047:002 (P756.02)	Parameter change-over error message: List entry	- (Read only)	general	U8	1	-	-
0x4048 (P601.00)	PID P-component	5.0 %	general	U16	10	P	-
0x4049 (P602.00)	PID I- component	400 ms	general	U16	1	P	-
0x404A (P603.00)	PID D-component	0.0 s	general	U8	10	P	-
0x404B (P604.00)	PID setpoint ramp	20.0 s	general	U16	10	P	-
0x404C:001 (P607.01)	PID influence: Acceleration time for showing	5.0 s	general	U16	10	P	-
0x404C:002 (P607.02)	PID influence: Deceleration time for masking out	5.0 s	general	U16	10	P	-
0x404D:001 (P608.01)	PID alarms: MIN alarm threshold	0.00 PID unit	general	I16	100	P	-
0x404D:002 (P608.02)	PID alarms: MAX alarm threshold	100.00 PID unit	general	I16	100	P	-
0x404D:003 (P608.03)	PID alarms: Monitoring bandwidth PID feedback signal	2.00 %	general	U16	100	P	-
0x404E:001 (P605.01)	PID setpoint limits: Minimum setpoint	-300.00 PID unit	general	I16	100	P	-
0x404E:002 (P605.02)	PID setpoint limits: Maximum setpoint	300.00 PID unit	general	I16	100	P	-
0x603F (P150.00)	Error code	- (Read only)	general	U16	1	O	t
0x6040	CiA: Controlword	0	general	U16	1	O	r
0x6041 (P780.00)	CiA: Statusword	- (Read only)	general	U16	1	O	t
0x6042 (P781.00)	Target velocity	0 rpm	general	I16	1	OK	r
0x6043 (P782.00)	Velocity demand	x rpm (Read only)	general	I16	1	O	t

* Default setting depending on the size.

Firmware version 04.00.00.00

Appendix

Parameter attribute list



Address	Name	Default setting	Category	Data type	Factor	A	M
0x6044 (P783.00)	Velocity actual value	x rpm (Read only)	general	I16	1	O	t
0x6046:001 (P784.01)	Velocity min max amount: Velocity min amount	0 rpm	general	U32	1	P	r
0x6046:002 (P784.02)	Velocity min max amount: Velocity max amount	2147483647 rpm	general	U32	1	P	r
0x6048:001 (P785.01)	Velocity acceleration: Delta speed	3000 rpm	general	U32	1	OP	r
0x6048:002 (P785.02)	Velocity acceleration: Delta time	10 s	general	U16	1	OP	r
0x6049:001 (P786.01)	Velocity deceleration: Delta speed	3000 rpm	general	U32	1	OP	r
0x6049:002 (P786.02)	Velocity deceleration: Delta time	10 s	general	U16	1	OP	r
0x605A	Quick stop option code	Quick stop ramp -> switch-on inhibited [2]	general	I16	1	P	-
0x605E (P791.00)	Fault reaction option code	Coasting [0]	general	I16	1	-	-
0x6060 (P301.00)	Modes of operation	MS: Velocity mode [-2]	general	I8	1	OP C	r
0x6061 (P788.00)	Modes of operation display	- (Read only)	general	I8	1	O	t
0x6071	Target torque	0.0 %	general	I16	10	OK	r
0x6072 (P326.00)	Max torque	250.0 %	general	U16	10	OP	r
0x6073 (P324.00)	Max current	200.0 %	general	U16	10	P	-
0x6074	Torque demand value	x.x % (Read only)	MCTRL	I16	10	O	-
0x6075 (P323.00)	Motor rated current	1.700 A *	MCTRL	U32	1000	PC	-
0x6076 (P325.00)	Motor rated torque	1.650 Nm *	MCTRL	U32	1000	PC	-
0x6077 (P107.00)	Torque actual value	x.x % (Read only)	general	I16	10	O	t
0x6078 (P103.00)	Current actual value	x.x % (Read only)	general	I16	10	O	t
0x6079	DC link circuit voltage	x.xxx V (Read only)	general	U32	1000	O	t
0x6080 (P322.00)	Max motor speed	6075 rpm	general	U32	1	OP	r
0x6085 (P790.00)	Quick stop deceleration	546000 pos. unit/s²	general	U32	1	P	-
0x60E0	Positive torque limit	250.0 %	general	U16	10	P	r
0x60E1	Negative torque limit	250.0 %	general	U16	10	P	r
0x60FD (P118.00)	Digital inputs	- (Read only)	general	U32	1	O	t
0x6402	Motor type	Squirrel cage induction [7]	MCTRL	U16	1	P	-
0x6502 (P789.00)	Supported drive modes	- (Read only)	general	U32	1	-	-

* Default setting depending on the size.

Firmware version 04.00.00.00

🏢 Lenze Drives GmbH
Postfach 10 13 52, D-31763 Hameln
Breslauer Straße 3, D-32699 Extertal
Germany
HR Lemgo B 6478
☎ +49 5154 82-0
📠 +49 5154 82-2800
@ lenze@lenze.com
🌐 www.lenze.com

✂ Lenze Service GmbH
Breslauer Straße 3, D-32699 Extertal
Germany
☎ 0080002446877 (24 h helpline)
📠 +49 5154 82-1112
@ service.de@lenze.com

S20160929P20160930

